

ISSN : 2442 - 4676

# PROCEEDING



## SEMINAR INTERNATIONAL THE 1<sup>st</sup> JOINT CONFERENCE INDONESIA-MALAYSIA- BANGLADESH-IRELAND (IJCIMBI) 2015

UUI Plenary Hall | April 27-28 2015 | Banda Aceh



INDONESIA



MALAYSIA



BANGLADESH



IRELAND



UNIVERSITAS  
**UBUDIYAH  
INDONESIA**  
CYBER UNIVERSITY

Official Website : [www.uui.ac.id](http://www.uui.ac.id)

## **EDITORIAL BOARD**

### **Key Advisors**

Brig Gen Datuk Prof Dr Kamarudin Hussin Vice Chancellor Universiti Malaysia Perlis.

Professor Ciaran O’Cathain, President of Atrlone Institute of Technology – Irlandia.

Dedy Zefrizal, ST, Chief of Ubudiyah Indonesia foundation

### **Person in Charge**

Marniati, S.E, M.Kes, The Rector of Universitas Ubudiyah Indonesia

### **EDITOR IN CHIEF**

HARRI SANTOSO., S.Psi., M.Ed

### **ASSOCIATE EDITOR**

FERDI NAZIRUN SIJABAT, SE., M.Ec.M.gt

### **EDITORIALS BOARD**

TETY SRIANA

AMIR MUKHLIS

ZHRUL MAIZI (UUI)

### **Reviewer**

#### **Universiti Malaysia Perlis**

Associate Prof. Dr. MOHD. MUSTAFA AL BAKRI ABDULLAH

Dr. NAJAMUDDIN

Dr. RIZALEFANDE

Dr. KHAIRUL NIZAM

#### **Daffodil International University - Bangladesh**

Prof. Dr. Md. Golam Rahman

Professor Rafiqul Islam

Prof. Dr. Muhammad Mahboob Ali

Prof. Dr. S.M. Mahbub Ul Haque Majumder

Prof. Dr. Yousuf Mahbubul Islam

Prof. Dr. Syed Akhter Hossain

Associate Prof Dr. Touhid Bhuiyan

Prof. Dr. Engr. A. K. M. Fazlul Hoque

Prof. Dr. Ahmad Ismail Mustafa

Prof. Dr. Md. Fayzur Rahman

Prof. Dr. A. K. M. Fazlul Haque

### **Editors**

Marniati, SE.M.Kes	( Universitas Ubudiyah Indonesia, Indonesia)
Harri Santoso, S.Psi.M.Ed Indonesia)	( Universitas Ubudiyah Indonesia,
Rita Nengsih,SE.Msi	( Universitas Ubudiyah Indonesia, Indonesia)
TEty Sriana,ST.MT	( Universitas Ubudiyah Indonesia, Indonesia)
Zahrul Maizi,ST	( Universitas Ubudiyah Indonesia, Indonesia)
Jurnalis J.Hius,ST.MBA	( Universitas Ubudiyah Indonesia, Indonesia)
Donny Arief Sumarto,ST.MT	( Universitas Ubudiyah Indonesia, Indonesia)
Ferdi Nazirun Sijabat,SE.M.Sc.Mgt Indonesia)	( Universitas Ubudiyah Indonesia,
Juli Dwina Puspitasari,SE.,M.Bus Indonesia)	( Universitas Ubudiyah Indonesia,
Rahmayani,S.Km.M.Kes Indonesia)	( Universitas Ubudiyah Indonesia,

### **INTERNATIONAL COMMITTEE OF IJCIMBI 2015**

Marniati, SE.M.Kes	( Universitas Ubudiyah Indonesia, Indonesia)
Harri Santoso, S.Psi.M.Ed	( Universitas Ubudiyah Indonesia, Indonesia)
Rita Nengsih,SE.Msi	( Universitas Ubudiyah Indonesia, Indonesia)
Tety Sriana,ST.MT	( Universitas Ubudiyah Indonesia, Indonesia)
Zahrul Maizi,ST	( Universitas Ubudiyah Indonesia, Indonesia)
Jurnalis J.Hius,ST.MBA	( Universitas Ubudiyah Indonesia, Indonesia)
Donny Arief Sumarto,ST.MT	( Universitas Ubudiyah Indonesia, Indonesia)
Ferdi Nazirun Sijabat,SE.M.Sc.Mgt	( Universitas Ubudiyah Indonesia, Indonesia)
Juli Dwina Puspitasari,SE.,M.Bus	( Universitas Ubudiyah Indonesia, Indonesia)
Rahmayani,S.Km.M.Kes	( Universitas Ubudiyah Indonesia, Indonesia)
Assoc.Prof.Dr.Rizal Afande Che Ismail	( University Malaysia Perlis, Malaysia)
Assoc.Prof Dr.Mohd Mustafa Al-Bakri Abdullah	( University Malaysia Perlis, Malaysia)
Prof.Dr.H.Zulkarnain Lubis	( University Malaysia Perlis, Malaysia)
Assoc.Prof.Dr.Aminul Islam	( University Malaysia Perlis, Malaysia)
Dr Abdullah Osman	( University Malaysia Perlis, Malaysia)
Dr Ummi Naiemah Saraih	( University Malaysia Perlis, Malaysia)
Dr Mohd Suberi Ab.Halim	( University Malaysia Perlis, Malaysia)
Engr.Dr.Mohammad Harith Amlus	( University Malaysia Perlis, Malaysia)
Dr Tuanku salha Tuanku Ahmad	( University Malaysia Perlis, Malaysia)
Mohd Zukime Mat Junoh	( University Malaysia Perlis, Malaysia)
Tuan Haji Rusli Abd.Hamid	( University Malaysia Perlis, Malaysia)

Ain Zuraini Zin Aris	( University Malaysia Perlis, Malaysia)
Syahida Kamil	( University Malaysia Perlis, Malaysia)
Hussen Nasir	( University Malaysia Perlis, Malaysia)
Muhammad Safizal Abdullah	( University Malaysia Perlis, Malaysia)
Mohammad Sharif Ismail	( University Malaysia Perlis, Malaysia)
Assoc. Prof Dr Yoshifumi Harada	( University Malaysia Perlis, Malaysia)
Dr.Suhairimi Abdullah	( University Malaysia Perlis, Malaysia)
Dr. Huzili Hussin	( University Malaysia Perlis, Malaysia)
Rafiza Abdul Razak	( University Malaysia Perlis, Malaysia)
Zarina Yahya	( University Malaysia Perlis, Malaysia)
Professor Dr.Md.Golam Rahman	( University Malaysia Perlis, Malaysia)
Professor Dr.Muhammad Mahboob Ali	(Daffodil International University, Bangladesh)
Professor Dr.Yousuf Mahbubul Islam	(Daffodil International University, Bangladesh)
Professor Dr Syed Akhter Hossain	(Daffodil International University, Bangladesh)
Professor Dr.Md Fayzur Rahman	(Daffodil International University, Bangladesh)
Professor Dr.A.K.M.Fazlul Haque	(Daffodil International University, Bangladesh)

### **CONTACT US**

Jalan Alue Naga, Desa Tibang, Kecamatan Syiah Kuala,  
Kota Banda Aceh, Indonesia

Phone: 62651 75555566, Fax: 62651 75555566

<http://ijcimbi.uui.ac.id/>



## TABLE OF CONTENT

COVER PAGE		
TITLE PAGE		
NOTICE OF DISCLAMER		
CONTENTS		
<b>FIELD : TECHNOLOGY</b>		
No	Title	Pages
1	Data Security System: File Inserted with Digital Signature Using IDEA	1 - 13
2	Analysis and Design of Document Delivery Security System: Encryption and Decryption Digital Signature using Digital Signature Algorithm (DSA)	14 - 24
3	Design of Operational Amplifier with Common-Mode Feedback Circuit for Pipeline ADC Application	25 - 31
4	EEG Signal Identification Based on Regression Coefficients Analysis Using BackPropagation for Brain Computer Interface	32 - 42
5	Conformity Tool For Land Evaluation in Android Mobile Application	43 - 51
6	Cutting Process Analysis of Environmental Friendly Composites from Oil Palm Empty Fruit Bunch Fibers Using Rotary Saw Machine	52 - 58
7	Formulating Standard Form of Construction Contract in Indonesian Context	59 - 76
8	Geospatial Information in Indonesia: Status, Challenges and Opportunities for Establishment, Innovation and Commercialization	77 – 89
9	Prototipe of Ordinal Rank List Application at Pangkalpinang High Attorney Babel	90 – 96
10	Structural, Optical and Electrical Properties of Ni-Doped Co Thin Films Prepared by Spray Pyrolysis Method	97 – 109
11	Investigation of long term evapotranspiration factor by using Hamon equation and NDVI data in forest area	110 – 119
12	Real Count Applications SMS Gateway Based for Fast, Precise, Honest, Fair and Transparent Election	120 – 128
13	Design and Implementation Of Color Tracking Method on Chess Robot Using Camera	129 – 143
14	Model for integrating peer-interaction into eBook technology	144 – 150
15	Identifying the Conflicts in the Software Requirement Engineering: A Literature Review	151 – 158
16	Suomi National Polar-orbiting Partnership Satellite Data Processing System to Produce Vegetation Indices	159 – 175
17	Performance of fast ICA Algorithm as Noise Reduction in Cellular Network	176 – 184
18	Simulation of Single Microring Resonator (MRR) using FDTD Technique for Sensing Applications	185 – 195
19	Peer Interaction in Social Media For Improvement Of EAP and Problem Solving Skills	196 – 207
20	Development of Pre-treatment Process for Aceh Low-rank Coal by Simultaneously Capture of Sulfur and Trace Element	208 – 214
21	Use of Social Media for supporting Administrative Rulemaking for a Private University in Bangladesh	215 – 219
22	The Development of Fastest Path Simulation for Emergency Vehicles Using VANET Technology	220 – 227
23	Minimizing The Cost for Repairing Road with Pavement Recycling	228 – 237
24	Implementation of Eight Pillars the Total Productive Maintenance at Water Supply Company	238 – 246
25	Solar Radiation Estimation Using Hargreaves Model	247 – 256
26	Comparing various search engines on their ability to find literal meaning and proposing a model for deriving benefits of ontology based search for words in the Qur'an	257 – 261
27	Potential of Solar Radiation to Generate Sine Wave Single Phase Transferless Photovoltaic Inverter	262 – 269
28	Comparative Study of Measured and Simulated Photovoltaic Performance Based on Statistical Analysis	270 – 280

29	Enzymatic Treatment to Facilitate Removal of Impurities in Raw Unclean Edible Bird Nest (EBN)	281 – 287
30	Model of Tree Shade Value by Contingent Valuation Technique on the Cocoa Agroforestry of Central Sulawesi Province	288 – 298
31	Disaster Risk Reduction as The Human Investment and Sustainable Development	299 – 301
32	Morphology of Spray Dried Red Pitaya Pigment Powders	302 – 306
33	Evaluation of Technology Readiness-Acceptance in Operation of Project Management Services	307 – 320

<b>FIELD: ECONOMICS</b>		
<b>No</b>	<b>Title</b>	<b>Pages</b>
34	The Effect Of Core Competency On Competitive Strategy And Its Implication On The Performance Of The Islamic Bankings And Islamic Microfinances In The Province Of Aceh, Indonesia	321 – 336
35	Sustainability in Microfinance : A Review of The Empirical Literature	337 – 344
36	Development Model of Small and Medium Skills and Cluster Based Economy in The Province of Aceh	345 – 354
37	Building Product Isolating Advantage and Its Affect on Marketing Performance	355 – 373
38	Green Chittagong, Clean Chittagong: How collaboration of Government & Business can create a better place for all	374 – 388
39	Risk, Efficiency And Performance Of Islamic Banking: Empirical Study on Islamic Bank in Indonesia	389 – 399
40	The Impact of Stress Source on The Worker's Work Spirit on Employee of BPR Mustakim Bank Banda Aceh	400 – 407
41	Route Determination and Scheduling Distribution of Raw Materials in Fast Food Franchise Restaurant	408 – 416
42	Analysis of Uncontrolable Influence Factors to Stock Return in Manufacturing Company Using Data Panel Method	417 - 424
43	Intellectual Capital Empowerment Through Comprehensive Intellectual Capital Management (an Interpretive Accounting Research)	425 - 443
44	Factors Influence Customers' Loyalty of Unilever Skin Care Product for Indonesian Market	444 - 462
45	Strategies for Strengthening The Green Economy on SMES Development in Sidoarjo District	463 - 475
46	Education, Economic Democration Growth in Achieving Success Business Strategy	476 - 493
47	A Study of Entrepreneurship Development in Bangladesh: Pros and Cons	494 - 503
48	Organizational Culture Impacts on Company's Ability to Adopt Continuous Improvement and Why ?	504 - 511
49	The Role of Entrepreneurship in the Production Function and its Effect on Revenue of Batik Industry in Central Java	512 - 523
50	Cooperatives Business Profits Determinant In Indonesia: A Partial Least Squares Approach	524 - 531
51	The Determinant Factors of Sectoral Stock Return in Bullish and Bearish Condition at Indonesian Capital Market	532 - 540
52	Timeliness Mediating Effect on Influence of Corporate Social Responsibility (CSR) Disclosure and Voluntary Disclosure Toward Informativeness of Earnings	541 - 554
53	Impact of Social Media Brand to Trust, Brand Affection, Brand Loyalty (an Cultivation Theories Approach)	555 - 562
54	Minimum Wage Level from Female Workers Perspective: Yogyakarta City Case	563 - 571
55	The Impact of price and income changes in nutrient intake in Urban Indonesia	572 - 588
56	The Effect Accounting Conservatism on the Company's Performance and Information Asymmetry as a Moderator: Evidence From Indonesia and Singapore	589 - 604
57	The Impact of Accounting Conservatism on Corporate Equity Valuation	605 - 618

	Moderated by Good Corporate Governance (An Empirical Study on LQ45 Companies for Period 2010-2012)	
58	Analyzing Report of Acceptance in Import Transaction Using Usance L/C Based on SAK (Standar Akuntansi Keuangan) in the Financial Statement	619 - 633
59	Business Ethics and Corporate Social Responsibility (CSR) in Sustainable Development: A conceptual framework	634 - 641
60	Image, Trust And Social Identification as Predictors of Customer Loyalty	642 - 652
61	Rent or Buy Decision at a Viscose Rayon Manufacturing Company	653 - 658
62	The Influence of Consumer's Perceived Value on Buying Behavior of Store Brands in Yogyakarta	659 - 672
63	The Determinant Factors of Market Orientation Over Financial Performance: Mediating Role of Market Performance	673 - 681
64	The Roles of Stakeholders in Controlling Field Conversion of Paddy Production Center in OKU Regency	682 -687
65	The Perception of Sabang Local Community About Marine Marketing Tourism	688 - 698
66	The Influence of Sales Promotion Framing on the Buying Interest Mediated by Transactional Value as the Value Perceived by Consumers	699 - 704
67	Human Capital and Entrepreneur	705 - 713
68	The consumption pattern, Lifestyle and Hypertension on Fishermen Community	714 - 717
69	Analysis of Community Empowerment For Elderly Population Quality As Human Resources in Medan	718 -727
70	Corporate Social Responsibility Policies In Developing Positive Image On Higher Education Institution At Tanri Abeng University, Jakarta, Indonesia	728 - 738
71	The Development of Social Capital BMT in Ciamis and Bantul Regencies (Human Resource and Leadership)	739 - 758
72	The Regulation of Syariah Principles in The Syariah Banking in Indonesia	759 - 776
73	Framework of Entrepreneurial Orientation and Competitive Advantage: (A Study of SMEs Performance in Aceh)	777 - 790
74	Factors Influencing Buyers to Purchase Green Residential Property	791 -799
75	Analyzing Sustainability of SMEs in Automotive Component Industry in Bekasi Regency	800 - 819
76	Aging Population in East Java and Demographic Characteristics	820 - 831
77	Impact Analysis Of Folk Cocoa Plantation Development Toward The Economic Development In Southeast Aceh District	832 - 842
78	Preparation of Model Village Tourism as Proposed for The Development of Sharia Village Tourism In Sleman District, Yogyakarta, Indonesia	843 -861
<b>SOCIAL SCIENCE</b>		
	<b>Title</b>	<b>Pages</b>
79	Cadar and Identity : Phenomenological Studies of Women Perspectives	862 - 871
80	Culture Values in Ramayana Ballet Prambanan Yogyakarta (an Assessment Semiotic)	872 - 883
81	Behavior of Women Child-Bearing Age Efforts of Breast Self-Examination in Early Detection of Breast Cancer in The Mandala Village of North Jayapura, Indonesia	884 - 888
82	Characteristics of Perinatal Who Died in Pringadi General Hospital Medan Indonesia	889 - 894
83	Drug Addict, Can it Be Cured in Malaysian Context	895 - 900
84	The Effectiveness of Brief Cognitive Behavioral Therapy Module on Locus Control Among Drug Abusers	901 - 911
85	Drug Abuse Among Higher Learning Institutions Students In Malaysia: Meta-Analysis of Exploratory Studies	912 - 917
86	The Effectiveness of At-Risk Criteria and Psychometric Measure in Identifying Drug Abuse Students in Malaysia Higher Learning Institutions	918 - 927
87	Primer Analysis on Detecting <i>Salmonella Typhi</i> Bacteria DNA Using PRC	928 - 933

	Technique	
88	The Qur'an-Based Physics Education at the level of Higher Education; Opportunities and Challenges	934 - 938
89	Characteristics of Functional Properties of Beans Protein Resulted Extraction of Hydrochloric Acid	939 - 949
90	Se'i Tradition for Pregnant Women in Peoples of East Nusa Tenggara	950 - 963
91	The Establishment of Child Health Cadre as Prevention For Foodborne Disease at Primary Schools	964 - 970
92	Study on The Indicators Village Aware (Concerned) HIV-AIDS in Indonesia	971 - 978
93	The Factors Which Affect The professionalism Development of Governmental Apparatus	979 - 987
94	Students Recap in Problem Based Learning for Developing Mastery of Integration Techniques of Mathematics Teacher Candidates	988 - 992
95	The Challenge of Health Schools Program's (UKS) Implementation: The Role of Steering Committee	993 - 1000
96	Interactive Applications Preserve Culture and Heritage on Art of Wrapping Traditional Food: Ketupat	1001 - 1018
97	Don't Let Javanese Language Become Extinct by Using Javanese Language to Preserve Cultural Heritage of Indonesia In Java Youth Scope	1019 - 1025
98	Taking a collaborative approach to solving students' problems at tertiary level	1026 - 1036
99	The Overview Application of School's Activity of Healthy Development Environment at UKS Program on Senior High School Level in Serang City	1037 - 1046
100	The Effectiveness of Airplane Flying in Improving Students' Speaking Ability (an Experimental Study at English Department of Stkip Bina Bangsa Getsempena)	1047 - 1055
101	Grand Design of Marine Based Curriculum for Early Childhood Education in The Province of Gorontalo	1056 - 1064
102	Teaching and Learning on Selected Topics in Electromagnetic Theory Course Using Problem-Based Learning Approach in a Class with a Large Number of Students: A Sharing Experience	1065 - 1070
103	Dialogical Learning Strategies to Form Character in The Alternative School "Qaryah Thayyibah" in Kalibening Village, Salatiga, Central Java	1071 - 1079
104	Affecting Factors Enhancing Drug Abuse In Indonesia	1080 - 1085
105	Oral Tradition "Andung", Toba Batak Society The Preservation and Culture Revitalization	1086 - 1096

# **TECHNOLOGY CHAPTER**



# Data Security System: File Inserted with Digital Signature Using IDEA

<sup>1</sup>Rizki Riandini Ardhiana, <sup>2</sup>R. Rumani Mangkudjaja & <sup>3</sup>Surya Michrandi Nasution

<sup>1</sup>Computer Science-Telkom University, Bandung, Indonesia, [al.ardhiana@gmail.com](mailto:al.ardhiana@gmail.com), 085861380891

<sup>2</sup>Computer Science-Telkom University, Bandung, Indonesia, [rumani@telkomuniversity.ac.id](mailto:rumani@telkomuniversity.ac.id),  
08122000847

<sup>3</sup>Computer Science-Telkom University, Bandung, Indonesia, [michrandi@telkomuniversity.aca.id](mailto:michrandi@telkomuniversity.aca.id),  
081221610007

## Abstract.

Data security is becoming common issue in communication for professional companies today. How the data can be kept secret and can not be hacked by the third party. This application offer data security for text, document, and excel files. Sender system takes binary file from these input, encrypts it using International Data Encryption Algorithm (IDEA). Strength of this algorithm is in its 8,5 rounds process, and 128-bit key. Data is inserted with unique Digital Signature (DS) to signing it before. Output of this process is textfile, wich will be sent to receiver. System in the receiver generates decrypt sub-key, decrypts the text file to get back the original file. The result of this research is decryption accuraction for text file is 100%, for document and excel file is 86,67%. Avalanche Effect (AE) value is between 49,32% - 50,77%. This application can enhance security in data communication.

**Keywords:** *binary file, cryptography, data security, decryption, digital signature, encryption, IDEA.*

## 1 Introduction

Security in data communication is highly needed todays. Almost every professional companies keep sharing data to their clients or relations online, while some of these data is personal and has limit access permission.

This problem needs effective solution. Encrypting the data will make it readable only for user that has decrypt key, and unreadable for others. IDEA is one of the strongest encryption algorithm since 1992. [1][3][7] It is a name of proven, secure, and universally aplicable block encryption algorithm, which permits effective protection of transmitted and stored data against unauthorized access by third parties. [4] Desktop application type is selected to fit the commonly used in company. The result of this research is the application can enhance security in data communication.

## 2 Cryptography [2]

Cryptography method to secure the data. Aspects that are needed to be fulfill wih cryptography are:

1. **Authentication**, recognition of the information
2. **Integrity**, detect whether there is any illegal changes on the data while it is being sent.
3. **Non-repudiation**
4. **Confidential**, keep the information from those who has no permission access.

Cryptography algorithm is consist of three functions, those are:

1. **Encryption**, change plaintext into unreadable called ciphertext, this process run on sender system.
2. **Decryption**, change ciphertext back into plaintext, this process run on receiver system.
3. **Key**, each algorithm has its own pattern of key to do the encryption and decryption process. Key is divided into two type, public and private key. These only stored in asymetrics algorithm.

### 3 IDEA Algorithm

IDEA is a development from *Proposed Encryption Algorithm (PES)*, made by Xuejia Lai and James Massey in 1990. [9] PES was introduced as replacement for *Data Encryption Standard (DES)* position. This algorithm was modified and published in 1991, it is known as *Improved Proposed Encryption Standard (IPES)*, after Bilham and Shamir described the technique of differential cryptanalysis. In 1992, its name changed to IDEA. [4]

#### 3.1 Key Generator

IDEA requires 128-bit *key* to generate 52 encrypt sub-key. The 128-bit key parsed into 8 encrypt sub-key:  $K_{1(1)}, K_{2(1)}, \dots, K_{8(1)}$ , each block consist of 16-bit length. The 128-bit key shifted left 25-bit, then parsed again into 8 encrypt sub-key:  $K_{1(2)}, K_{2(2)}, \dots, K_{8(2)}$ . This process repeat 7 times until  $K_{1(7)}, K_{2(7)}, K_{3(7)}$ , and  $K_{4(7)}$ . The four last bit blocks is not used as key because IDEA only needs 52 blocks of encrypt sub-key.

Decrypt sub-key of IDEA is generated from its encrypt sub-key (K) using three combination of mathematics operations: *additive invers* ( $2^{16}$ ) (represented with:  $-K$ ), *multiplicative invers* ( $2^{16}+1$ ) (represented with:  $K^{-1}$ ), and copy of encrypt sub-key. *Additive invers* ( $2^{16}$ ) from K is A number in range 0 until ( $2^{16}-1$ ) that completed:

$$(A+K) \bmod (2^{16}) = 0 \tag{1}$$

While *multiplicative invers* from K is B number in range 0 until ( $2^{16}$ ) that completed:

$$(B*K) \bmod (2^{16}+1) = 1 \tag{2}$$

Pattern of encryption sub-key and decryption sub-key relation is shown in Table 1.

**Table 1** Decryption Sub-key.

Generate Decryption Sub-key from Encryption Sub-key											
Encryption Sub-key						Decryption Sub-key					
$K_{1(1)}$	$K_{2(1)}$	$K_{3(1)}$	$K_{4(1)}$	$K_{5(1)}$	$K_{6(1)}$	$K_{1(9)}^{-1}$	$-K_{2(9)}$	$-K_{3(9)}$	$K_{4(9)}^{-1}$	$K_{5(8)}$	$K_{6(8)}$
$K_{1(2)}$	$K_{2(2)}$	$K_{3(2)}$	$K_{4(2)}$	$K_{5(2)}$	$K_{6(2)}$	$K_{1(8)}^{-1}$	$-K_{3(8)}$	$-K_{2(8)}$	$K_{4(8)}^{-1}$	$K_{5(7)}$	$K_{6(7)}$
$K_{1(3)}$	$K_{2(3)}$	$K_{3(3)}$	$K_{4(3)}$	$K_{5(3)}$	$K_{6(3)}$	$K_{1(7)}^{-1}$	$-K_{3(7)}$	$-K_{2(7)}$	$K_{4(7)}^{-1}$	$K_{5(6)}$	$K_{6(6)}$
$K_{1(4)}$	$K_{2(4)}$	$K_{3(4)}$	$K_{4(4)}$	$K_{5(4)}$	$K_{6(4)}$	$K_{1(6)}^{-1}$	$-K_{3(6)}$	$-K_{2(6)}$	$K_{4(6)}^{-1}$	$K_{5(5)}$	$K_{6(5)}$
$K_{1(5)}$	$K_{2(5)}$	$K_{3(5)}$	$K_{4(5)}$	$K_{5(5)}$	$K_{6(5)}$	$K_{1(5)}^{-1}$	$-K_{3(5)}$	$-K_{2(5)}$	$K_{4(5)}^{-1}$	$K_{5(4)}$	$K_{6(4)}$
$K_{1(6)}$	$K_{2(6)}$	$K_{3(6)}$	$K_{4(6)}$	$K_{5(6)}$	$K_{6(6)}$	$K_{1(4)}^{-1}$	$-K_{3(4)}$	$-K_{2(4)}$	$K_{4(4)}^{-1}$	$K_{5(3)}$	$K_{6(3)}$
$K_{1(7)}$	$K_{2(7)}$	$K_{3(7)}$	$K_{4(7)}$	$K_{5(7)}$	$K_{6(7)}$	$K_{1(3)}^{-1}$	$-K_{3(3)}$	$-K_{2(3)}$	$K_{4(3)}^{-1}$	$K_{5(2)}$	$K_{6(2)}$
$K_{1(8)}$	$K_{2(8)}$	$K_{3(8)}$	$K_{4(8)}$	$K_{5(8)}$	$K_{6(8)}$	$K_{1(2)}^{-1}$	$-K_{3(2)}$	$-K_{2(2)}$	$K_{4(2)}^{-1}$	$K_{5(1)}$	$K_{6(1)}$
	$K_{1(9)}$	$K_{2(9)}$	$K_{3(9)}$	$K_{4(9)}$		$K_{1(1)}^{-1}$	$-K_{2(1)}$	$-K_{3(1)}$	$K_{4(1)}$		

#### 3.2 Encryption-Decryption Process

IDEA algorithm consists of 8,5 rounds. Input of each round is 64-bit plaintext that divided into 4 blocks, each 16-bit in length. These 4 blocks called as  $X_1, X_2, X_3,$  and  $X_4$ . These processed by 6 blocks encryption sub-key. Each full rounds has 14 steps. [7] Three algebra operation used in this algorithm [5]:

$$\text{Additive mod } (2^{16}) = (X + k) \bmod (2^{16}) \tag{3}$$

$$\text{Multiplicative mod } (2^{16}+1) = (X \cdot k) \bmod (2^{16}+1) \tag{4}$$

$$X \text{ XOR } k \tag{5}$$

IDEA is believed to be of strong cryptographic strength because of these operation, provides desirable statistical independence between plaintext and ciphertext, and its property of having iterative rounds made differential attacks difficult. [5] Confusion and diffusion also fulfilled with it. Confusion is

deleting relation between ciphertext and encryption sub-key. Diffusion is spreading plaintext structure into ciphertext so there is no statistical relation between them. It prevents cryptanalysis. Output from each encryption block are  $Y_1, Y_2, Y_3,$  and  $Y_4$  which called as ciphertext. Besides input and sub-key, decryption process is identic with encryption process. [8]

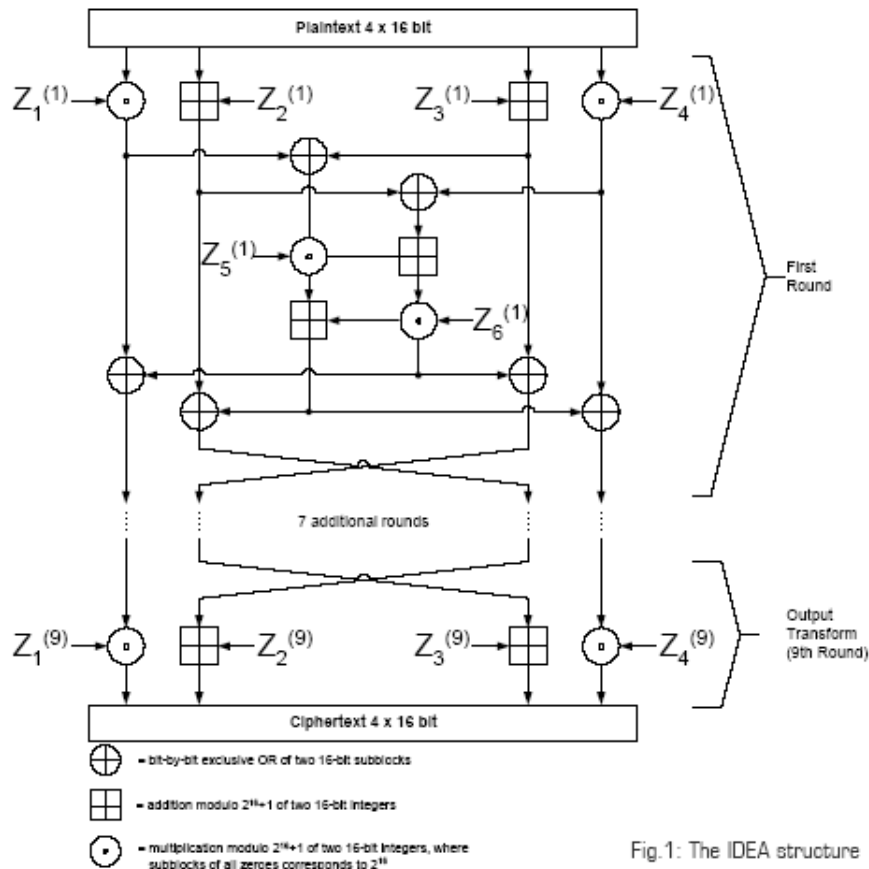


Figure 1 IDEA Process

## 4 Digital Signature

Digital Signature (DS) is a package of bit that use one-way hash function. This DS is as strong as manual signature. Characteristics of DS are [2]:

1. **Authentication**, information integrity recognition.
2. **One-time usage**, DS can not be moved to another data. Each data will generate unique DS. If there is any changes to the data, DS is not valid anymore.
3. **DS validation**, data validation on the receiver system by comparing DS value.

Infrastructure for DS is consist of:

1. **Security Measures for the Private Key**, DS is generated using private key which is held under highly secure conditions by the person concerned. This DS stored in a chip such as smart-card. An emergent approach is for the card itself to refuse access to the private key, except when the card measures some aspects of the holder physical's person like biometrics method.
2. **Public Key Infrastructure**

## 5 Digital Signature

### 5.1 Functionality of System

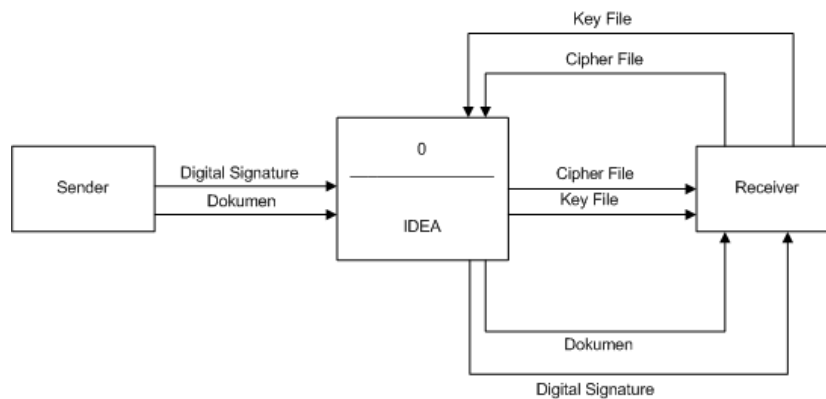
This desktop application is made to enhance security of data communication. Data is inserted with DS as the sender sign. This inserted data then encrypted and decrypted using IDEA. Functionality of this system is shown in Table 2.

**Table 2** Functionality of System

<b>Functionality of System</b>	
<b>Main Function and Feature</b>	IDEA encryption-decryption, DS insertion
<b>Performance</b>	Secure .txt/.docx/.xlsx file
<b>Interface</b>	Desktop application
<b>Sender System</b>	
<b>Input</b>	File, DS, key.
<b>Output</b>	Ciphertext file.
<b>Receiver System</b>	
<b>Input</b>	Ciphertext file, key.
<b>Output</b>	Document, DS.

### 5.2 Data Flow Diagram

Data Flow Diagram–0 for this system is as shown in Fig. 2.



**Figure 2** Data Flow Diagram - 1

Data Flow Diagram–1 for this system is as shown in Fig. 3.

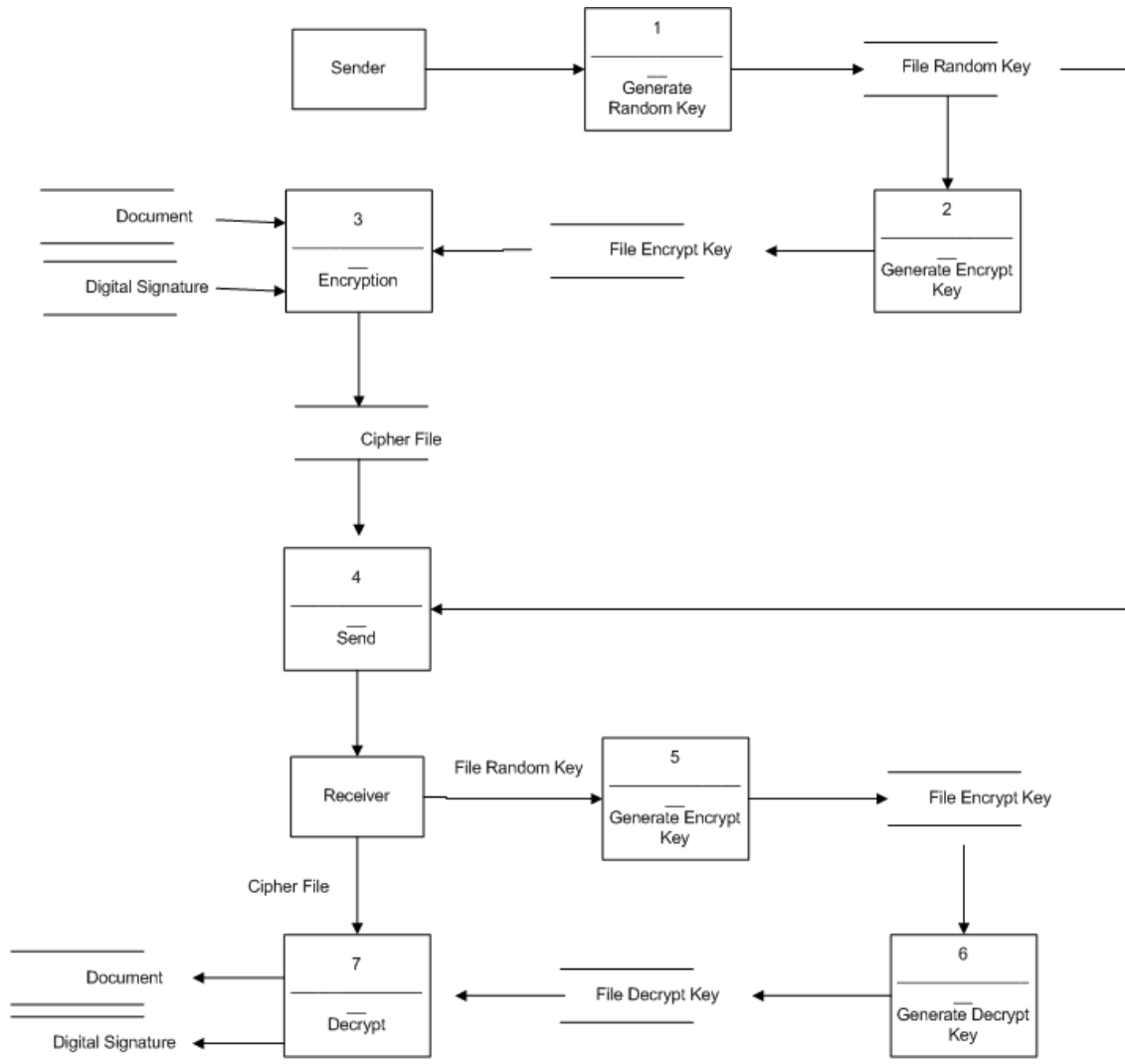


Figure 3 Data Flow Diagram – 2

## 6 Experimental Result and Analysis

Efficiency, Avalanche Effect (AE), and Execution Time have been used to measure the security level of the data. [6] Experiments on this security system include: (1) Execution Time, (2) Avalanche Effect, (3) Decryption Accuracy, and (4) Beta Testing.

### 6.1 Execution Time Experiment

Encryption time counted after plaintext file and encryption sub-key have been made. Decryption time counted after decryption sub-key has been made. Result of execution time experiment is shown in Table 3.

Table 3 Text file Execution Time

File Name	Exp.	Time*	
		Encryption	Decryption
data1.txt	1	68,486	26,862
	2	134,564	47,432
data2.txt	1	47,879	17,544
	2	46,239	15,365



data3.txt	1	55,243	29,386
	2	63,602	24,0
data4.txt	1	18,743	5,525
	2	16,870	6,328
data5.txt	1	29,349	7,243
	2	32,693	13,480

**Table 4** Docx file Execution Time

File Name	Exp.	Time*	
		Encryption	Decryption
Dat2.docx	1	1121,632	384,023
	2	1307,549	480,684
Dat3.docx	1	1010,678	399,192
	2	1266,023	409,127
Dat4.docx	1	1119,323	337,093
	2	949,950	327,148
Dat5.docx	1	999,751	340,008
	2	1184,238	427,893
Dat7.docx	1	1022,409	373,953
	2	1106,705	379,611

Content of data2.txt is same with dat2.docx, data3.txt is same with dat3.docx. From the table, execution time value-both encryption and decryption process-for .docx file is 20 times higher than .txt file with same content. It is because of the binary file from .docx file is including the default format from microsoft word. While textfile is already a binary file. Although the content of these file is same but the binary file-that used as input of this system-is different.

**Table 5** Xlsx file Execution Time

File Name	Exp.	Time*	
		Encryption	Decryption
ex1.xlsx	1	1382,261	462,544
	2	1129,613	479,043
	3	1403,307	760,680
ex2.xlsx	1	1369,319	531,407
	2	1386,734	501,738
	3	1937,803	781,975
ex3.xlsx	1	1261,613	489,766
	2	1387,932	493,891
	3	1993,767	815,335

## 6.2 Avalanche Effect Experiment

AE is the phenomenon that describes the effect in the output ciphertext if a single or few bits are changed in the plaintext. [6] AE standard is between 45% - 60%. Highest value of AE is 50% because each bit has same probability to be changed or not changed. AE value is using calculation (different bit/total bit)\*100%. Result of AE experiment is shown in Table 6-8.

**Table 6** Avalanche Effect of text file

File Name	Exp.	Total Bit	Different Bit	AE (%)
data1.txt	1	51096	26071	50,0441
	2		26330	50,5413
	3		26073	50,048
data2.txt	1	26176	12950	49,4728
	2		13189	50,3858
	3		13192	50,3973

data3.txt	1	32896	16600	50,4621
	2		16390	49,8237
	3		16589	50,4286
data4.txt	1	10240	5085	49,6582
	2		5090	49,707
	3		5182	50,6055
data5.txt	1	19712	9851	49,746
	2		9836	49,8985
	3		9953	50,4921

**Table 7** Avalanche Effect of Docx file

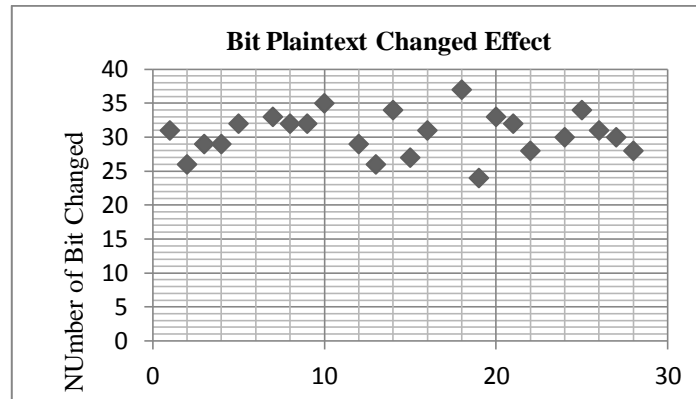
File Name	Exp.	Total Bit	Different Bit	AE (%)
dat2.docx	1	369984	187853	50,7733
	2		184477	49,8608
	3		183914	49,8086
dat3.docx	1	355648	176100	49,5153
	2		180136	50,6501
	3		180132	50,6490
dat4.docx	1	353408	176223	49,5809
	2		176983	50,0789
	3		174961	49,5068
dat5.docx	1	348224	173295	49,7654
	2		175763	50,4741
	3		174961	50,2438
dat7.docx	1	338112	168405	49,8075
	2		168316	49,7881
	3		170150	50,3236

**Table 8** Avalanche Effect of Xlsx file

File Name	Exp.	Total Bit	Different Bit	AE (%)
ex1.xlsx	1	225856	113935	50,4459
	2		114190	50,5588
	3		113493	50,2502
	4		111459	49,3496
	5		111402	49,3243
ex2.xlsx	1	224704	112720	50,1638
	2		113348	50,4423
	3		112983	50,2808
	4		112121	49,8972
	5		113201	49,990
ex3.xlsx	1	229120	114913	50,1541
	2		115878	50,5752
	3		113708	49,6281
	4		113243	49,4252
	5		115878	50,5752

Table above shows both .txt, .docx, and .xlsx, each data has AE value between 49,32% - 50,77%.

Another scenario is to test the independency between plaintext and ciphertext. Half plaintext bit is changed, then it encrypted using same key. The original ciphertext compared with the new ciphertext produced. Result of this experiment is shown in Fig. 4.



**Figure 4** Plaintext Bit Changed

From graphic above, 1-bit plaintext changed is effecting between 24-37 bit changed in ciphertext.

### 6.3 Accuracy Experiment

Comparison between decrypted file and the original file is the parameter on this experiment. Process stated accurate if decrypted file is exactly same with its original file. For each type of data, .txt, .docx, and .xlsx, decrypted files are compared with original files. Result of this experiment is shown in Table 9-11.

**Table 9** Text file Decryption

File Name	Original File	Decrypted File
data3.txt	<p>Data security is becoming common issue in communication for professional companies today. How the data can be kept secret and can not be hacked by the third party.</p> <p>Digital Signature (DS) as sender authentication, is generated from the data itself using Digital Signature Algorithm (DSA) with random key. Each data generates unique DS, it spreaded over the data. Next, data is encrypted using Intenational Data Encryption Algorithm (IDEA). Strength of this algorithm is in its 8.5 rounds process, and its 128-bit random key. System in the receiver will decrypt, take DS from data, then verify it by comparing DS with the result of decryption process. If there is any changes while it is being sent, the system give notification to user that the data is not valid . This application made in C++ with Microsoft Visual Studio. The result of research is the application can enhance security in data communication.</p> <p>Keywords: DSA, IDEA, security, cryptography</p>	<p>Data security is becoming common issue in communication for professional companies today. How the data can be kept secret and can not be hacked by the third party.</p> <p>Digital Signature (DS) as sender authentication, is generated from the data itself using Digital Signature Algorithm (DSA) with random key. Each data generates unique DS, it spreaded over the data. Next, data is encrypted using Intenational Data Encryption Algorithm (IDEA). Strength of this algorithm is in its 8.5 rounds process, and its 128-bit random key. System in the receiver will decrypt, take DS from data, then verify it by comparing DS with the result of decryption process. If there is any changes while it is being sent, the system give notification to user that the data is not valid . This application made in C++ with Microsoft Visual Studio. The result of research is the application can enhance security in data communication.</p> <p>Keywords: DSA, IDEA, security, cryptography</p>

data1.txt

**BAB 1**  
**PENDAHULUAN**  
**Latar Belakang**  
Pengiriman pesan melalui e-mail banyak digunakan sebagai media komunikasi antar lembaga profesional. Beberapa pesan diantaranya bersifat rahasia dan memiliki pembatasan hak akses. Sementara e-mail tidak menyediakan sistem keamanan selain verifikasi akun dan password.  
Untuk menyelesaikan permasalahan ini, dibutuhkan metode pengamanan yang efektif untuk mencegah pihak yang tidak berhak mengetahui isi pesan. Pengamanan akan dilakukan terhadap isi pesan, yaitu dengan melakukan enkripsi. Hanya pihak yang memiliki kunci yang dapat mendekripsi dan membaca pesan yang dikirim. Diperlukan pula cara agar sisi penerima mengetahui validitas pesan yang diterima. Maka sebelum proses enkripsi, akan dilakukan penyisipan digital signature (DS) ke dalam dokumen sebagai informasi unik tentang pengirim asli.  
Proses enkripsi menggunakan algoritma International Data Encryption Algorithm (IDEA) yang merupakan salah satu algoritma terbaik menurut beberapa literatur. Penelitian ini diharapkan dapat menjawab kebutuhan akan keamanan pengiriman pesan.

**Rumusan Masalah**  
Perumusan masalah dalam penelitian ini adalah: Bagaimana menyisipkan Hash dan DS pada pesan asli. Bagaimana mengamankan pesan dengan menggunakan algoritma enkripsi IDEA. Bagaimana membuka kembali pesan dengan menggunakan algoritma dekripsi IDEA. Bagaimana mengekstraksi Hash dan DS dari pesan setelah proses dekripsi. Bagaimana meningkatkan akurasi dan kecepatan proses enkripsi dekripsi. Bagaimana mengimplementasikan untuk input dalam berbagai ekstensi.

**Tujuan Penelitian**  
Tujuan dari penelitian ini adalah:

**BAB 1**  
**PENDAHULUAN**  
**Latar Belakang**  
Pengiriman pesan melalui e-mail banyak digunakan sebagai media komunikasi antar lembaga profesional. Beberapa pesan diantaranya bersifat rahasia dan memiliki pembatasan hak akses. Sementara e-mail tidak menyediakan sistem keamanan selain verifikasi akun dan password.  
Untuk menyelesaikan permasalahan ini, dibutuhkan metode pengamanan yang efektif untuk mencegah pihak yang tidak berhak mengetahui isi pesan. Pengamanan akan dilakukan terhadap isi pesan, yaitu dengan melakukan enkripsi. Hanya pihak yang memiliki kunci yang dapat mendekripsi dan membaca pesan yang dikirim. Diperlukan pula cara agar sisi penerima mengetahui validitas pesan yang diterima. Maka sebelum proses enkripsi, akan dilakukan penyisipan digital signature (DS) dalam dokumen sebagai informasi unik tentang pengirim asli.  
Proses enkripsi menggunakan algoritma International Data Encryption Algorithm (IDEA) yang merupakan salah satu algoritma terbaik menurut beberapa literatur. Penelitian ini diharapkan dapat menjawab kebutuhan akan keamanan pengiriman pesan.

**Rumusan Masalah**  
Perumusan masalah dalam penelitian ini adalah: Bagaimana menyisipkan Hash dan DS pada pesan asli. Bagaimana mengamankan pesan dengan menggunakan algoritma enkripsi IDEA. Bagaimana membuka kembali pesan dengan menggunakan algoritma dekripsi IDEA. Bagaimana mengekstraksi Hash dan DS dari pesan setelah proses dekripsi. Bagaimana meningkatkan akurasi dan kecepatan proses enkripsi dekripsi. Bagaimana mengimplementasikan untuk input dalam berbagai ekstensi.

**Tujuan Penelitian**  
Tujuan dari penelitian ini adalah:

This Table 9 shows original file and decrypted file from data1.txt and data3.txt. The decrypted file is exactly same with the original.

**Table 10** Text file Decryption

File Name	Original File	Decrypted File
dat2.docx	<p><i>Figure axis labels are often a source of confusion. Try to use words rather than symbols. As an example, write the quantity "Time", or "Time T" not just "T". Put units in parentheses. Do not label axes only with units. As in Fig. 1, write "Time (hour)", not just "hour". Large figures and tables may span both columns, but may not extend into the page margins. Figure captions should be below the figures; table captions should be above the tables. Do not put captions in "text boxes" linked to the figures. Do not put borders around your figures.</i></p> <p><i>All figures and tables must be in place in the text near, but not before, where they are first mentioned. Use the abbreviation "Fig. 1," even at the beginning of a sentence.</i></p>	<p><i>Figure axis labels are often a source of confusion. Try to use words rather than symbols. As an example, write the quantity "Time", or "Time T" not just "T". Put units in parentheses. Do not label axes only with units. As in Fig. 1, write "Time (hour)", not just "hour". Large figures and tables may span both columns, but may not extend into the page margins. Figure captions should be below the figures; table captions should be above the tables. Do not put captions in "text boxes" linked to the figures. Do not put borders around your figures.</i></p> <p><i>All figures and tables must be in place in the text near, but not before, where they are first mentioned. Use the abbreviation "Fig. 1," even at the beginning of a sentence.</i></p>

dat3.docx

**Data security is becoming common issue in communication for professional companies today. How the data can be kept secret and can not be hacked by the third party.**

Digital Signature (DS) as sender authentication, is generated from the data itself using Digital Signature Algorithm (DSA) with random key. Each data generates unique DS, it spreaded over the data. Next, data is encrypted using Intenational Data Encryption Algorithm (IDEA). Strength of this algorithm is in its 8.5 rounds process, and its 128-bit random key. System in the receiver will decrypt, take DS from data, then verify it by comparing DS with the result of decryption process. If there is any changes while it is being sent, the system give notification to user that the data is not valid . This application made in C++ with Microsoft Visual Studio.

The result of research is the application can enhance security in data communication.

Keywords: DSA, IDEA, security, cryptography

**Data security is becoming common issue in communication for professional companies today. How the data can be kept secret and can not be hacked by the third party.**

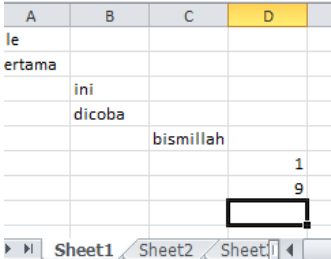
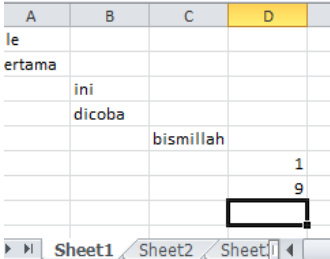
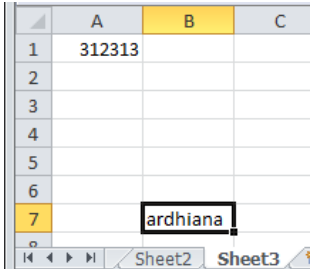
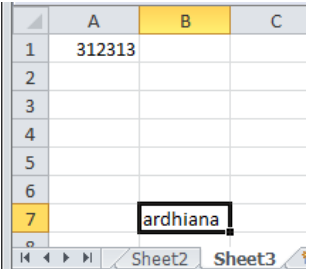
Digital Signature (DS) as sender authentication, is generated from the data itself using Digital Signature Algorithm (DSA) with random key. Each data generates unique DS, it spreaded over the data. Next, data is encrypted using Intenational Data Encryption Algorithm (IDEA). Strength of this algorithm is in its 8.5 rounds process, and its 128-bit random key. System in the receiver will decrypt, take DS from data, then verify it by comparing DS with the result of decryption process. If there is any changes while it is being sent, the system give notification to user that the data is not valid . This application made in C++ with Microsoft Visual Studio.

The result of research is the application can enhance security in data communication.

Keywords: DSA, IDEA, security, cryptography

This Table 10 shows original file and decrypted file from dat2.docx and dat3.docx. All of the text formatting in the original file is also made in decrypted file. These files are similar.

**Table 11** Text file Decryption

File Name	Original File	Decrypted File
ex1.xlsx		
ex2.xlsx		

This Table 11 shows original file and decrypted file. File ex1.xlsx consist of 1 sheet while ex3.xlsx consist of 3 sheets. Both file is succeed to be decrypted.

**Table 12** Decryption Accuracy

Data Type	File Name	Total Experiment	Accurate	Not Accurate
.txt	Data1.txt	3	3	0
	Data2.txt	3	3	0
	Data3.txt	3	3	0



	Data4.txt	3	3	0
	Data5.txt	3	3	0
.docx	Dat2.docx	6	5	1
	Dat3.docx	6	6	0
	Dat4.docx	6	4	2
	Dat5.docx	6	6	0
	Dat7.docx	6	5	1
.xlsx	Ex1.xlsx	4	3	1
	Ex2.xlsx	4	4	0
	Ex3.xlsx	4	3	1

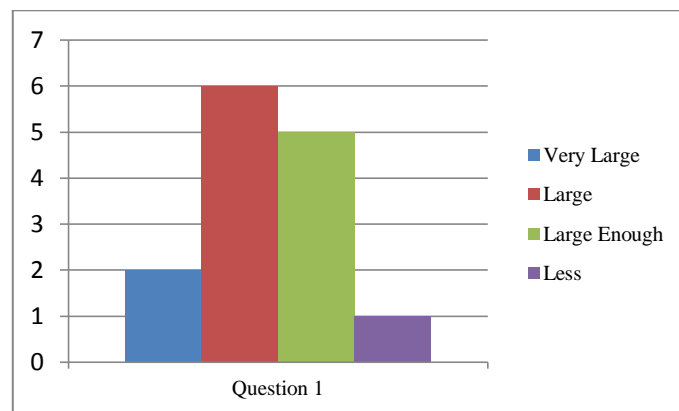
Result of this experiment is textfile has 100% accuracy. While .docx and .xlsx has 86,7% accuracy.

## 6.4 Beta Testing

Respondents of this beta testing are 12 employees from several company. Recapitulation of 6 questions related to this application are shown below.

### (1) Data Security Needs

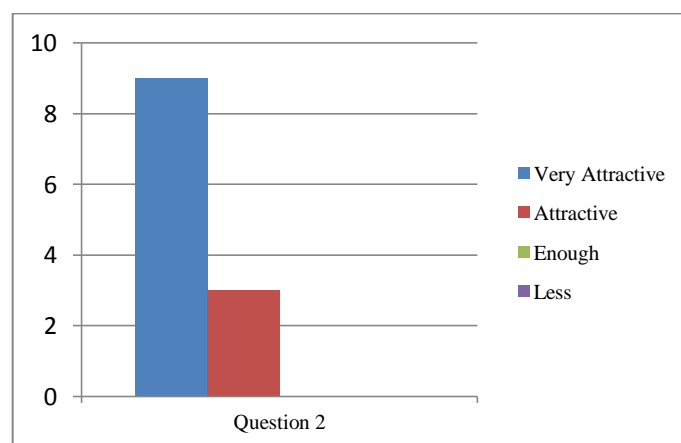
Needs of data security level shown in Fig. 5. It shows that this kind of application need to be improved.



**Figure 5** Data Security Needs Graphic

### (2) Application Interface

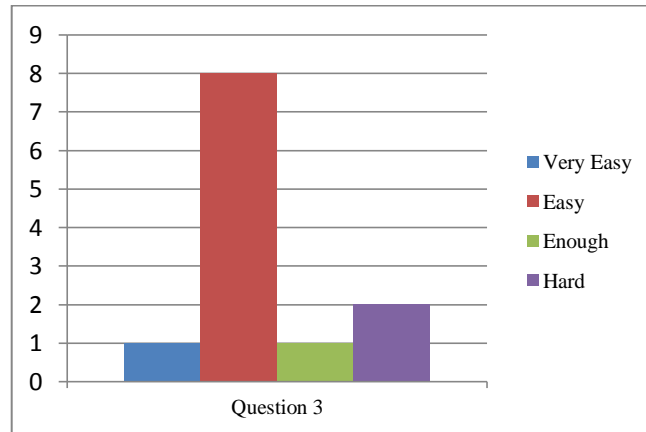
Great interface will increase the user number. Valaution on application interface is shown in Fig. 6.



**Figure 6** Application Interface Graphic

(3) User Friendly

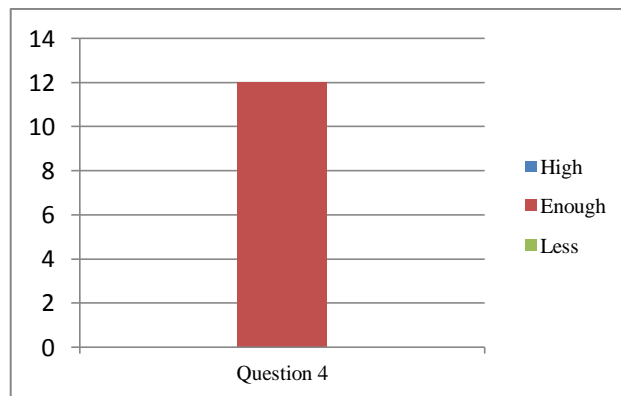
Result of this application user friendly level is shown in Fig. 7.



**Figure 7** User Friendly Graphic

(4) Security Parameters

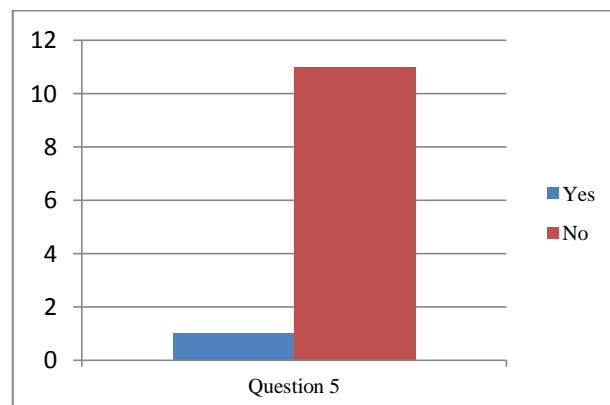
Valuation of whether security parameters already fulfilled or not is shown in Fig. 8.



**Figure 8** Security Parameters Graphic

(5) Use Similar Application

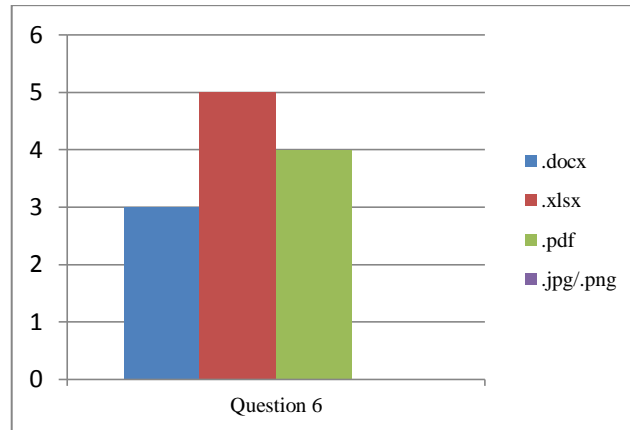
The number of respondents that has use another similar application is shown in Fig. 10.



**Figure 9** Use Similar Application Graphic

(6) Data Type

Type of data that usually transmitted by respondents is shown in Fig. 10.



**Figure 10** Data Type Graphic

## 7 Conclusion

- 1 DS succeed to be inserted into the data with appending DS value to binary value.
- 2 File with .txt, .docx, and .xlsx extension succeed to be encrypted with taking the binary file of these files as the input for system.
- 3 Decryption process succeed to generate file that exactly same with the original file. Accuration value for .txt file is 100% while for .docx and .xlsx file is 86.67%.
- 4 This desktop base security system reach 60% for user friendly percentage.

## 8 References

- [1] A. Tanenbaum. 1997. *Computer Network 3rd Edition*. Prentice Hall: Upper Sadle River, NJ.
- [2] Ariyus, Dony. 2008. *Pengantar Ilmu Kriptografi Teori, Analisis, dan Implementasi*, Indonesia, Yogyakarta: C.V Andi Offset.
- [3] Basu, Sandipan. International Data Encryption Algorithm (IDEA) – A Typical Ilustration. *JGRCS vol.2, no.7, July 2011. ISSN:2229-371x*.
- [4] Hoffmann, Nick. *A Simplified IDEA Algorithm*. Kentucky: Department of Mathematics Northern Kentucky University.
- [5] Leong, M.P, O.Y.H. Cheung, K.H.Tsoi, and P.H.W. Leong. *A Bit Serial Implemetation of teh International Data Encryption Algorithm IDEA*. Hong Kong: The Chinese University of Hong Kong.
- [6] Patidar, Ganesh, Nitin Agrawal, and Sitendra Tarmakar. A Block Based Encryption Model to Improve Avalanche Effect for Data Security. *IJSRP vol.3, Issue 1, Jan 2013. ISSN:2250-3153*.
- [7] Schneier, B. *Applied Cryptography, Second Edition*. New York: John Willey and Sons.
- [8] Singh, Harivans Pratap, Shweta Verma, and Shailendra Mishra. Secure-International Data Encryption Algorithm. *IJAREEIE vol.2, Issue 2, Feb 2013. ISSN:2320-3765*.
- [9] X. Lai and J.L Massey. A Proposal for a New Block Encryption Standard. *Advances in Cryptology-Eurocrypt '90, LNCS 473, Springer-Verlag, Berlin 1991*.

# Analysis and Design of Document Delivery Security System: Encryption and Decryption Digital Signature using Digital Signature Algorithm (DSA)

<sup>1</sup>Fadhila Cahya Wardhani, <sup>2</sup>R. Rumani M. & <sup>3</sup>Surya Michrandi Nasution

<sup>1</sup>Telkom University Bandung - Indonesia, fadhilacahya@gmail.com, 6285795959879

<sup>2</sup>Telkom University Bandung - Indonesia, rumani@telkomuniversity.ac.id, 628122000847

<sup>3</sup>Telkom University Bandung - Indonesia, michrandi@telkomuniversity.ac.id, 6281221610007

## Abstract.

Many people already used facilities in the internet, like e-mail. By using an e-mail, we can send the document (such as .docx, .xlsx, and .txt) easily. But, when we send the document, maybe a man changed the document point illegally without sender and receiver knows. Without the good safety facilities, receiver will receive its document mistrustful. To resolve that problem, digital signature is made.

In this design of security system, we use Digital Signature Algorithm (DSA). DSA is a specific algorithm for digital signature. This algorithm is used by sender to generate key pair and generate digital signature using private key (encryption process / signing process), and the public key is used to verify it (decryption process / verifying process). The result of digital signature encryption is alphabets and numbers communication.

Using this security system, user can verify the file that has been sent by comparing digital signature that already changed from file to message digest.

**Keywords:** *digital signature, Digital Signature Algorithm (DSA), generate digital signature, generate key pair, verify*

## 1 Introduction

Many people must have been using the existing facilities in the internet, such as e-mail. By using e-mail, we can send a document easily. However, when sending a document, a man can change the contents illegally without be known by sender and receiver. Without good security facilities, the recipient will receive the document with no suspect changes.

In this research, researchers made system application that can resolve the issue. Users of this application can send files such as .docx, .xlsx, and .txt which is inserted with digital signature by its *xml* file.

Therefore, a security system is made. It can change the file into a string of words that cannot be understood using other cryptography algorithm in half of DSA's signing process. Then, it is verified in verifying process.

## 2 Basic Theory

### 2.1 Cryptography

Cryptography is a science and art to protect messages confidentiality by encrypting it to be a part that cannot be understood by people.

Cryptography consist of encryption and decryption process. Encryption process changes the readable code to be the unreadable code [1, p.43]. Encryption can be meant as code or cipher and the original message as plaintext. Beside that, decryption is a process to get back the unreadable code using the same algorithm while encrypting it [1, p.45].

Cryptography is to get security services (known as security aspects) [6]:

1. Confidentiality or secrecy, for keeping the message to unreadable by third party.
2. Data integrity, for ensuring that the message still original, never manipulated.
3. Authentication, related to identification or introduction all of system or just a part of system.
4. Non-repudiation, for preventing repudiation by sender or receiver.

Aspect number 1 can be done by encryption or decryption. And aspects from 2 till 4 can be done by digital signature.

## 2.2 Digital Signature [5, p.241]

Digital signature is a cryptograph value which is a series of bits that related to the message and the sender. Two ways for signing the message are:

1. Encryption  
The encrypted message means that the message already signed.
2. Digital signature using hash function  
Digital signature is generated by hash function of message. Hash value is a simple code from message. This digital signature then appended to the message.

Because of digital signature is a substitute of manual signature, so it has same characteristics, are as follows:

1. The signature is an authentic proofing.  
Message digest in signing process must be same as message digest in verifying process (authentication).
2. The signature cannot be forgotten.
3. The signature cannot be moved or reuse.
4. The signature document cannot be changed.  
If the message already changed, message digest in receiver's side is different from sender's side (data integrity).
5. The signature cannot be repudiated.  
Signing process uses a private key's sender, so the sender cannot repudiate it (non-repudiation).

## 2.3 Secure Hash Algorithm-1 (SHA-1) [7]

SHA is a *one-way hash* function which is made by NIST. It can be used together with DSS (Digital Signature Standard). SHA-1 algorithm input is a message within  $2^{64}$  bits (2.147.483.648 gigabyte), and SHA-1 algorithm output is 160 bits. SHA is secure because of its design is impossible to get the same message digest from any messages.

## 2.4 Digital Signature Algorithm (DSA)

DSA is a standard algorithm for digital signature. This algorithm has two main functions, are as follows [5, p.248]:

1. Signature generation
2. Signature verification

DSA is an asymmetry cryptography algorithm, so every user have a pairing of private and public key. DSA uses SHA hash function to change the message to be a 160 bits of message digest. The result of digital signature is numbers as string of binary in computer.

DSA requires that the private or public key pairs are used for digital signature generation and verification be generated with respect to a particular set of domain parameters.

## 2.5 OpenSSL [2]

OpenSSL is open source implementation from SSL (Secure Socket Layer) protocol and TLS (Transport Layer Security). SSL and TLS is continuation of cryptography protocol that preparing secure communication in internet.



OpenSSL library is used to implement all of SSL protocol versions, especially for symmetry cryptography algorithm and asymmetry cryptography algorithm usage, hash algorithm and message digest, *pseudorandom* number generator, and also digital signature to manipulate general certificate format and key material management.

In this research, we only used OpenSSL to get  $p$  and  $q$  value. The  $p$ ,  $q$ , and  $g$  members, known as DSA parameters, are public values that must be generated before a key pair can be generated. Because they are public values, no harm will come if a potential attacker discovers them.

## 2.6 Discrete Logarithm Problem (DLP) [4]

Confidentiality or secrecy aspect can be filled if the time to break the algorithm is long enough. If we wish to discuss the security of cryptosystems againsts computational attacks, then we are naturally led to discussion of what is a feasible computation. In this section, we shall survey some complexity issues involving the Discrete Logarithm Problem (DLP):

$$\begin{aligned} g^x &= h \pmod{p} \\ g^x &= a, \text{ find such an } x \end{aligned} \quad (1)$$

The random  $x$  value well known as discrete logarithm from  $h$  base for  $g$ . This formulation of the problem might be harder to solve. It can also make a difference if we are analyzing an algorithm for solving DLP, since we may need to know that  $a \in \langle g \rangle$  in order to carry out the analysis.

In DSA, the formula to break DLP is:

$$O = \exp(c (\ln p)^{1/3} (\ln \ln p)^{2/3}) \quad (2)$$

With  $c \approx 1.923$  and  $p$  = sum of bits of prime number.

## 3 System Design

### 3.1 System Decryption

The system specifications, are as follows:

1. Can do *SHA-1 process* from *xml* file of message.
2. Can do *signing process*, either to generate parameters of DSA and to generate digital signature then insert it may using another cryptography algorithm.
3. Can do *verifying process*.

Design is done by making a system application where the users can enter the chosen message that will be sent, change it to message digest, generate parameters of DSA, generate signature, insert digital signature to original message, and then verify it.

### 3.2 System Design

The design includes general groove of system and flowcharts of system.

#### 3.2.1 General Groove of System

General groove of this security system, are as follows:

1. Sender chooses the file that will be sent.
2. Sender makes hash value from the chosen file using SHA-1 algorithm, then it well known as message digest.
3. Sender generates a pairing of key, private key and public key.
4. Message digest and private key are inserted to original file, then it well known as encrypted file.
5. Send the encrypted file by e-mail.
6. By using public key's sender, the receiver verifies digital signature value from the decryption of the original file.
7. If the inserted digital signature value is same as the digital signature value in receiver, then the file is valid.

### 3.2.2 Flowcharts of System

#### 3.2.2.1 Flowchart of SHA-1 Algorithm

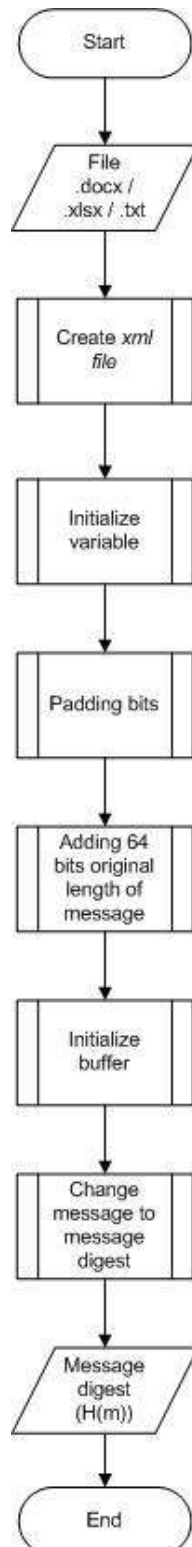


Figure 1 Flowchart of SHA-1 algorithm

### 3.2.2.2 Flowchart of Generating Parameters

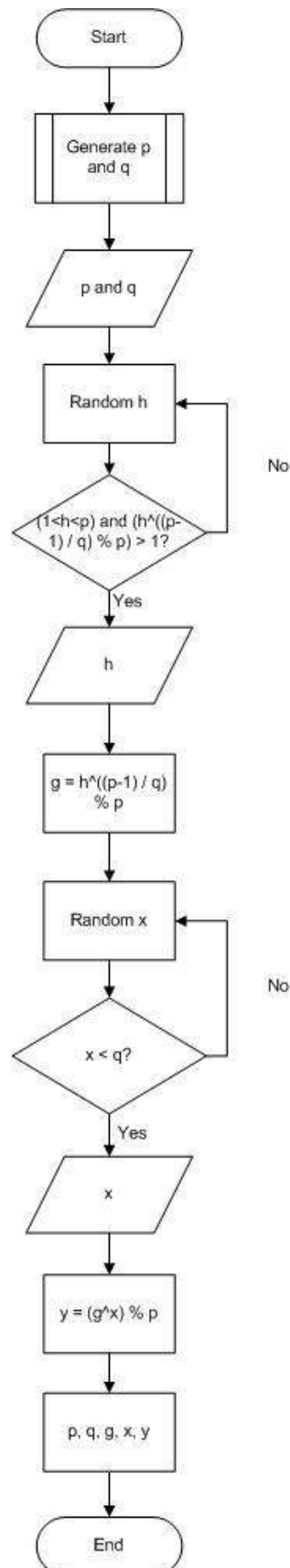
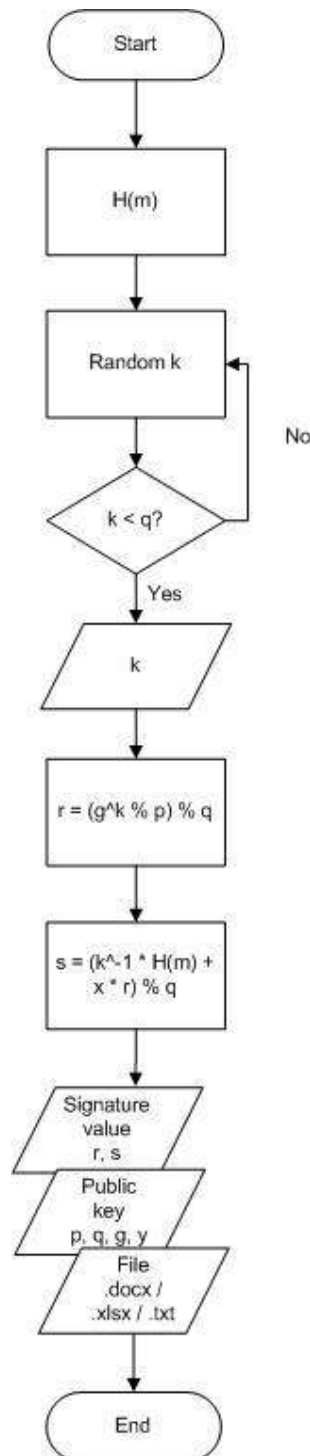


Figure 2 Flowchart of generating parameters

The  $p$  member is a prime number that is randomly generated. Initially, the proposed standard fixed the length of the prime at 512 bits. Due to much criticism, this was later changed to allow a range between 512 and 1024 bits. The length of the prime must be a multiple of 64 bits, however. OpenSSL does not enforce the 1024 bits upper bound, but it is not a good idea to use a prime larger than 1024 bits—many programs may not be able to use the keys that result from such a large prime. The  $q$  member is a prime factor of  $p-1$ . The value of  $q$  must also be exactly 160 bits in length. The  $g$  member is the result of a mathematical expression involving a randomly chosen integer, as well as  $p$  and  $q$  [2, p.196].

### 3.2.2.3 Flowchart of Generating Digital Signature



**Figure 3** Flowchart of generating digital signature

### 3.2.2.4 Flowchart of Verification

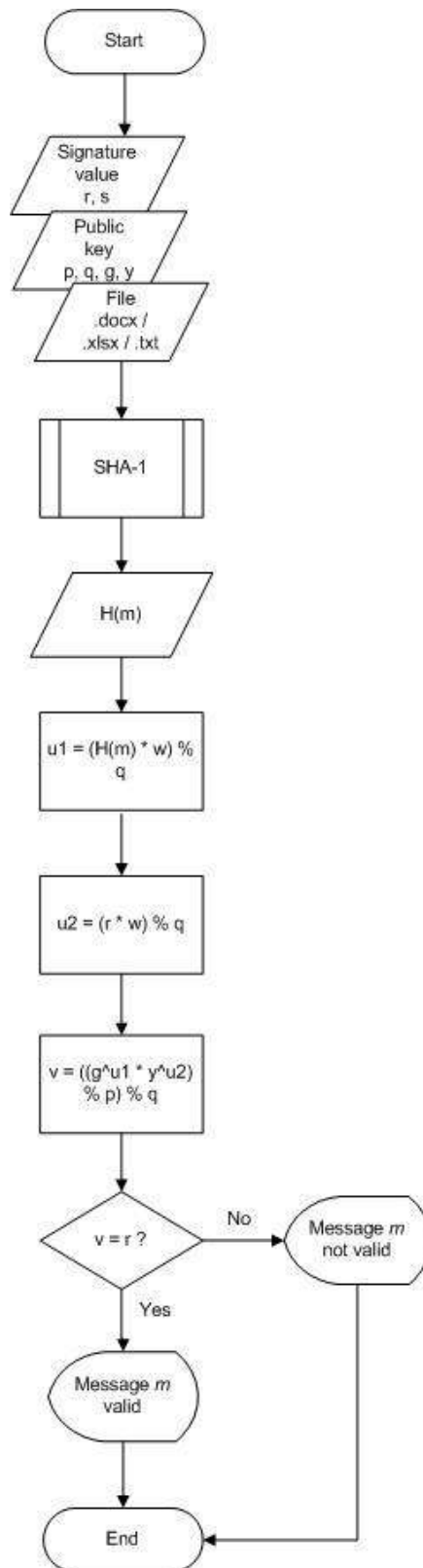


Figure 4 Flowchart of verification

## 4 Implementation and Testing

### 4.1 System Implementation

Based on the system design, the implementation used hardware and software, are as follows:

1. Hardware
  - a. Laptop Dell Inspiron 1525, Intel® Core™ 2 Duo CPU T5750 @ 2.00GHz 2.00 GHz, RAM 4.00 GB
  - b. Laptop HP ProBook 4420s, Intel® Core™ i3 CPU M 350 @ 2.27GHz 2.27 GHz, RAM 2.00 GB
  - c. PC Samsung S19A10N, Intel® Core™ i5-2400 CPU @ 3.10GHz 3.30 GHz, RAM 4.00 GB
  - d. PC LG E2242, Intel® Core™ i7-3770 CPU @ 3.40GHz 3.90 GHz, RAM 4.00 GB
2. Software
  - a. Windows 8 Professional 32-bits operating system
  - b. Microsoft Visual Studio 2010 (Visual C++)
  - c. .NET Framework 4.0
  - d. OpenSSL library for generating  $p$  and  $q$
  - e. Adobe Photoshop CS3 for designing the display of application

### 4.2 Security Testing

Although the main focus of DSA is its verification, but if the file can be changed by third party while sending it by e-mail, the system can be said not secure. Because of that, we need a test to break Discrete logarithm Problem (DLP).

For example, with  $c \approx 1.923$  and  $p = 512$  bits, we can get these counting:

$$\begin{aligned}
 O &= \exp(c (\ln p)^{1/3} (\ln \ln p)^{2/3}) \\
 &= \exp(1,923 (\ln 2^{512})^{1/3} (\ln \ln 2^{512})^{2/3}) \\
 &= \exp(44,31245775008714578801848381706) \\
 &= 1,756531249 * 10^{19}
 \end{aligned} \tag{1}$$

Assume that hardware can count one of million instructions in one second (MIPS), so:

$$\begin{aligned}
 &\text{Sum of instructions per 1 year} \\
 &= 60 * 60 * 24 * 365 * 1000000 \\
 &= 3153600000000 \text{ instructions per year}
 \end{aligned} \tag{2}$$

$$\begin{aligned}
 &\text{Implementation timing} \\
 &= 1,756531249 * 10^{19} / 3153600000000 \\
 &= 556992,4052 \text{ MIPS year}
 \end{aligned} \tag{3}$$

With the implementation timing above, and if  $p$  bits is larger, possibility to break it by third party should take a long time.

Beside DLP testing, security degree also can be measured by the key. The random  $h$  and  $x$  value have enough security degree, because of its pattern that cannot be guessed by third party. And also, by appending DSA with the other cryptography algorithm in half of DSA's signing process, it can be more secure.

### 4.3 Result of SHA-1 Timing Process

This testing is done by every 9-10 KB's file format.

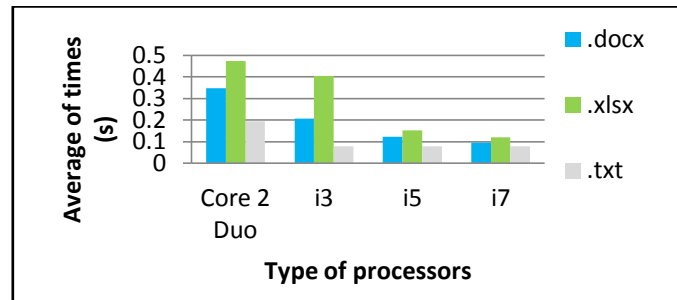


Figure 5 Result of SHA-1 timing process

### 4.4 Result of Generate Parameters Timing Process

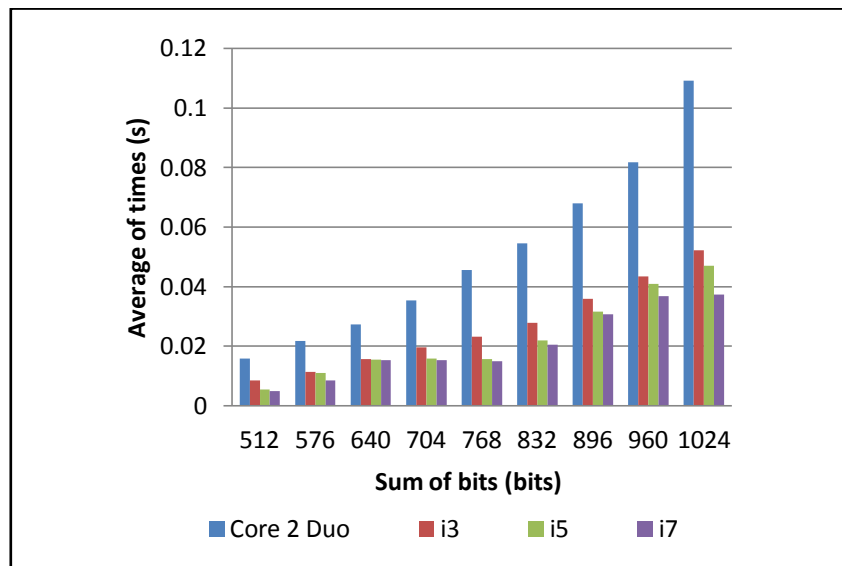


Figure 6 Result of generate parameters timing process

#### 4.5 Result of Generate Digital Signature Timing Process

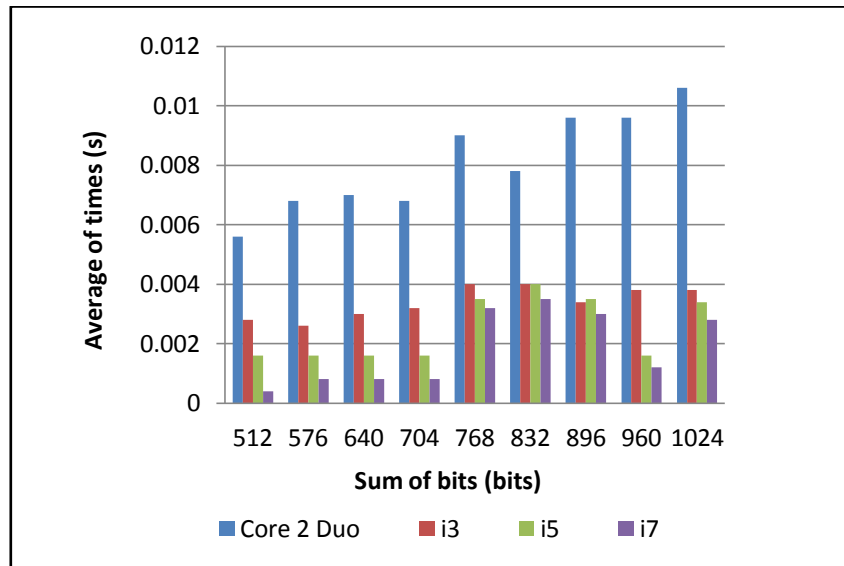


Figure 7 Result of generate digital signature timing process

#### 4.6 Result of SHA-1 Accuracy

Table 1 SHA-1 accuracy

No.	File name	Conditions	Message digest	Result
1	dat2.docx	Original text	EEC91E7F8B3556166073D3838 A41C86F2D42B9	Accurate
		Change text formatting	E2D29309A52FDABBF96F1205 CC4B2CA92E1E9CC	Accurate
		Change alignment	5071ADAB753952B982CDA7D2 6974B964CFF7443F	Accurate
		Change text(s)	5284F72D5A823EEF3216C1CE1 805C33CD3CD523D	Accurate
		Delete text(s)	34F2A3AB6F6207E8621B506D7 19742882FD9CC93	Accurate
2	ex1.xlsx	Original text	6484183D88BD2F6E304204368 D5CAB3A5B98A19F	Accurate
		Change text formatting	E7799D44FFB3B1A54A7836F15 E60601DF6DE7EE0	Accurate
		Change alignment	EDEA21F7424C8E9ED01353110 2F20F62FEC94D	Accurate
		Change text(s)	8CB8ED0829BF556D7C0DA53A 89AD70C2BAD72CEC	Accurate
		Delete text(s)	4AF5465690362D4365C0ADCD8 B8473CC85AE96E4	Accurate
3	hosts.txt	Original text	8142425D4BD4D68FDAB09840 CDC87B92136F0874	Accurate
		Change text(s)	4912175C83AAF1D9233AB55E7 26F20293E38785B	Accurate
		Delete text(s)	90D4268CD576C2B6E7A48E792 47CC8BBC60FDF6C	Accurate



## 4.7 Result of Document Validity

**Table 2** Document validity

No.	File name	Conditions	Result
1	dat2.docx	No changing	Valid
		Change public key	Not valid
		Change digital signature	Not valid
2	ex1.xlsx	No changing	Valid
		Change public key	Not valid
		Change digital signature	Not valid
3	hosts.txt	No changing	Valid
		Change public key	Not valid
		Change digital signature	Not valid

## 5 Conclusion

From the implementation and test results, we draw some concluding remarks, as follows:

1. The type of processors and the size of file influence SHA-1 timing process. File content also influences it. File content of .docx and .xlsx format is variant, it makes tag element of their xml file will be increase.
2. SHA-1 timing process of .txt file is lower than docx and .xlsx format. It is caused by the difference of .txt which is not an extracted file from many xml files.
3. The timing process is related to size of bits that being used.
4. Message digest on program has 100% accuracy. It is a must, so if the file has changed, message digest is different.
5. Changing in file content, public key, or digital signature makes the file not valid.

## References

- [1] Andi, Offset. (2003). Memahami Model Enkripsi & Security Data, Yogyakarta: Wahana Komputer.
- [2] Chandra, Pravir et al. (2002). Network Security with OpenSSL. USA: O'Reilly & Associatos, Inc.
- [3] Federal Information Processing Standards Publication (FIPS PUB) 186-3. (June, 2009). USA: National Institute of Standards and Technology.
- [4] McCurley, Kevin S. (1990). The Discrete Logarithm Problem. Proceedings of Symposis in Applied Mathematics, 42, 49-74.
- [5] Munir, Rinaldi. (2006). Kriptografi, Bandung: Informatika.
- [6] Scheiner, Bruce. (1996). Applied Cryptography (2nd ed), New York: John Wiley & Sons.
- [7] Stallings, William. (2005). Cryptography and Network Security (5th ed), New York: Prentice Hall International.

# Design of Operational Amplifier with Common-Mode Feedback Circuit for Pipeline ADC Application

Izatul Syafina Ishak, S.A.Z. Murad and M.F. Ahmad

School of Microelectronic Engineering, Universiti Malaysia Perlis, Pauh Putra Campus, 02600 Arau,  
Perlis, MALAYSIA.  
izatul\_syafina@yahoo.com

## Abstract.

The development a high-performance design of analog circuits becomes increasingly challenging with the continuous trend towards reducing the supply voltage and low power consumption without neglecting the trade-off among other performance parameters. This paper presents the design and implements of operational amplifier (op-amp) with common-mode feedback (CMFB) circuit for pipeline Analog-to-Digital Converter (ADC) application using 0.13  $\mu\text{m}$  Silterra CMOS technology. The folded cascode topology is employed as a main op-amp design because it provides high gain and high bandwidth besides low power consumption. The simulation results show that the DC gain of 64.5 dB along 133.1 MHz unity gain bandwidth (UGB) are achieved for a 1 pF load capacitor. The phase margin (PM) of 68.4 degrees and the slew rate of 22.6 V/ $\mu\text{s}$  with settling time of 72.4 ns are obtained. The power consumption of this op-amp is 0.3 mW through supply voltage of 1.8 V.

**Keywords:** *Analog-to-digital converter; common-mode feedback; gain bandwidth; operational amplifier; phase margin; pipeline.*

## 1 Introduction

Operational amplifier is a core element and integral part for most analog and mixed-signal systems. The behavioral of op-amp such as high gain, high input impedance, low output impedance, high bandwidth and fast settling makes this device often used amongst multiplicity of applications like in pipeline ADC. Traditionally, op-amp can be classified into several topologies which are telescopic, folded cascode, two-stage and gain-boosted [1]. Each topology has their own compensation, but they can be applied in any design op-amp circuit by considering the performance parameter.

A telescopic op-amp is simple topology and provided a high gain as well faster performance [2-3]. This topology is called as 'telescopic' because the cascades are attached between the voltage supplies with the transistor in the differential pair, occurs in a structure where each branch of the transistor connected directly together in a straight line [4]. Commonly, the telescopic topology has a slighter swing because of lesser current legs and produces a small power consumption and low noise.

In a folded cascode op-amp, the topology is normally customized from the telescopic op-amp and it issues higher gain and performance [5-6] compared to the telescopic because it consumes more currents legs. This topology is called 'folded cascode' because of small signal current is folded up or to down [1]. Generally, this op-amp allows the particular input common-mode level of being near to the voltage supplies as well as performing a high output swing, wide input common-mode range and preferably steering in low voltage supply circuits [4]. However, this topology contributed greater noise that effect from the more currents legs.

## 2 Design constraints

Design constraints is a key element in preparing the best performance of op-amp circuit. As a requirement of a high speed and high accuracy in pipeline ADC, there are numerous constraint parameters that should be considered such as gain, unity gain bandwidth, phase margin, slew rate and also output swing. Each parameter constraints are explained as follows:

### 2.1 Gain

Ideally, the gain is the product of the transconductance structure over the output resistances of the load structure that express as:

$$\text{Gain} = G_m \cdot R_{\text{out}} \quad (1)$$

where the gain extremely depends on the frequency of the input signal of an amplifier.

### 2.2 Unity gain bandwidth

The unity gain bandwidth state that the frequency at which the open loop gain of the amplifier is unity with the maximum capacitance at the output node.

$$\text{UBW} = 2\pi f \cdot C_L \quad (2)$$

### 2.3 Phase Margin

The purpose of phase margin (PM) is to determine the stability of the amplifier where the higher values of PM will allow the output signal to achieve a stable state without much swing.

$$\text{Phase margin (PM)} = \tan^{-1} [ g_m / (2\pi f \cdot C_L) ] \quad (3)$$

Noted that the PM depends on the applications [1].

### 2.4 Slew rate

Slew rate is defined by the output capacitance and the current across the output branch:

$$\text{Slew rate} = I_{\text{out}} / C_L \quad (4)$$

### 2.5 Output swing

This constraint relates to the output of the op-amp where the saturation voltage of load structure mainly defines the output swing of the op-amp. Commonly, most systems employing op amps require large voltage swings to accommodate a wide range of signal amplitude [1].

$$\text{Output swing} = ( V_{DD} - V_{\text{max/min}} ) / 2 \quad (5)$$

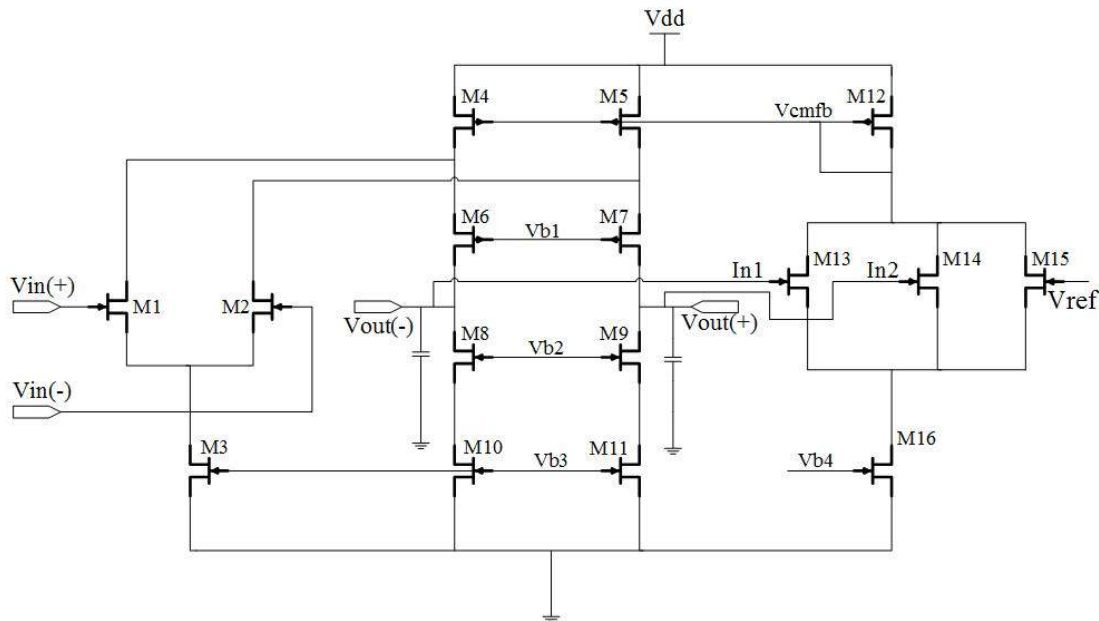
### 3 Design Implementation

According to the op-amp specifications as presented in Table 1, the desired op-amp topology was determined. Folded cascode topology idyllically to be principal op-amp for this work since the design has been used in [7] for obtaining a high and fast settling and high unity gain bandwidth besides low power consumption.

**Table 1** Op-amp specs for Pipeline ADC.

No	Parameter	Value
1	Voltage supply	1.8 V
2	$V_{in}$	$\pm 1.2$ V
3	$V_{out}$	1.2 V
4	DC gain	>70 dB
5	Phase Margin	>50 °
6	Unity gain bandwidth	>130 MHz

The architecture of folded cascode op-amp with common-mode feedback is illustrated as Figure 2. Traditionally, the folded cascode op-amp has been designed by using a pair of PMOS type or NMOS type for the input range of op-amp through the limits of input common mode range [7]. For this work, the NMOS type is chosen to be an input of the differential amplifier since this input type can assign more large output gain compare to PMOS input type.



**Figure 1** Folded cascode op-amp with CMFB architecture.

As in Figure 1, the folded cascode topology consists of two different structures which are NMOS differential amplifier (M1-M3) and folded cascode structure (M4-M11). The open loop voltage gain can be determined as:

$$A_v = g_m \cdot R_o \quad (6)$$

where  $g_m$  is a short-circuit transconductances of the output current gain across the transistor of M6 and  $R_o$  is the output impedance of folded cascode by looking into the drains of M6 and M8,

$$R_o = g_{m6} \cdot r_{o6} (r_{o1} || r_{o4}) || (g_{m8} \cdot r_{o8} \cdot r_{o10}) \quad (7)$$

So, the gain is expressed as:

$$A_v = g_m \cdot \{ [g_{m6} \cdot r_{o6} \cdot (r_{o1} || r_{o4})] || [g_{m8} \cdot r_{o8} \cdot r_{o10}] \} \quad (8)$$

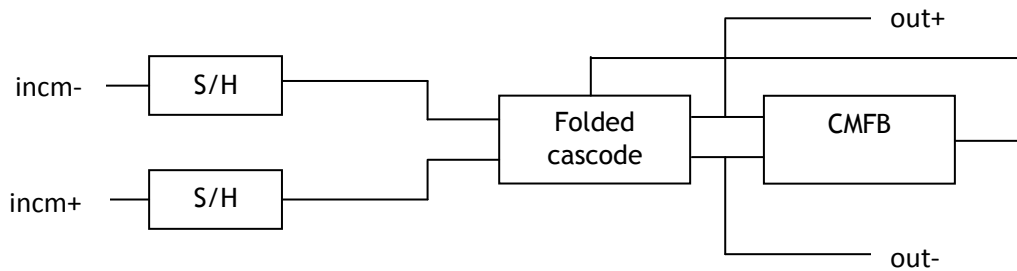
Meanwhile, the gain bandwidth of the folded cascode circuit is:

$$GBW = g_{m1} / C_L \quad (9)$$

where  $g_{m1}$  is a transconductance of M1 and  $C_L$  is the capacitance at the output node.

A CMFB circuit (M12-M16) is designed in order to fix the voltages at high impedances node to the desired voltage value of CMRR performance while ensuring the stability of common-mode voltage for fully differential op-amp. As referred in Figure 2, M12 is assigned to be a feedback to the folded cascode op-amp while M13 and M14 is an input of CMFB that attaches to the output of folded cascode op-amp and M15 represents as a reference voltage. This CMFB architecture is modified from the conventional amplifier as in Figure 1(a) in [8]. The modification is based on M12 because its need a stable voltage to fed the folded cascode op-amp.

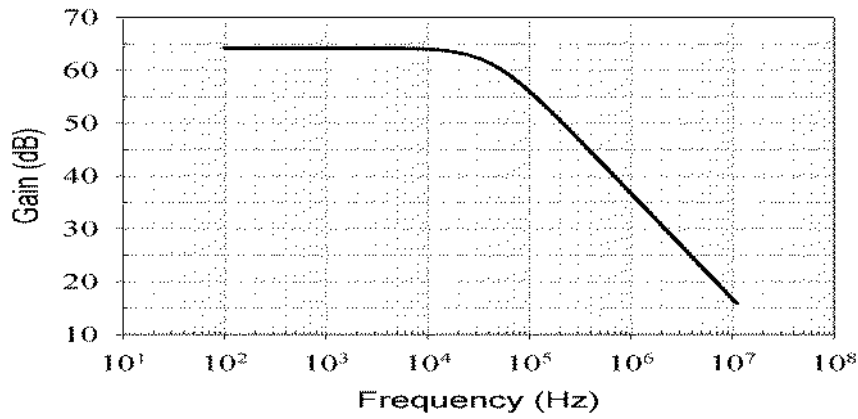
Subsequently, these two circuit blocks are implemented in 1.5-bit per stage pipeline ADC as shown in Figure 2 in order to simulate the circuit performances. The result is discussed in section below.



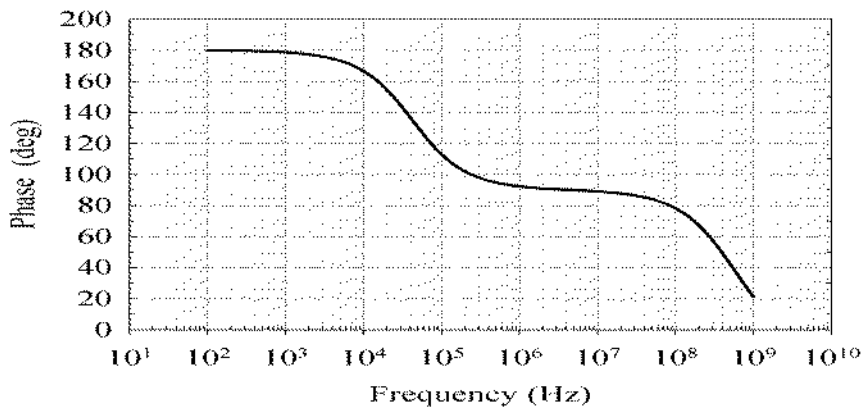
**Figure 2** Implementation circuit in 1.5-bit per stage ADC.

## 4 Result

The proposed folded cascode op-amp was designed using Cadence Software and implemented in 0.13  $\mu\text{m}$  process technology with 1.8 V supply voltage whereas the simulation of circuit via Cadence Virtuoso spectre. The circuit design is analyzed in two methods which are AC analysis and Transient analysis. Figure 3 shows the AC analysis result of the proposed circuit. The simulated DC gain demonstrated 64.5 dB with 68.4 degrees of phase margin (PM) as shown in Figure 3 (a) and Figure 3 (b), respectively. Meanwhile, the transient analysis result is depicted in Figure 4. The slew rate performs 22.6 V/ $\mu\text{s}$  among 72.4 ns of settling times.



(a) Gain.



(b) Phase margin.

Figure 3 AC analysis.

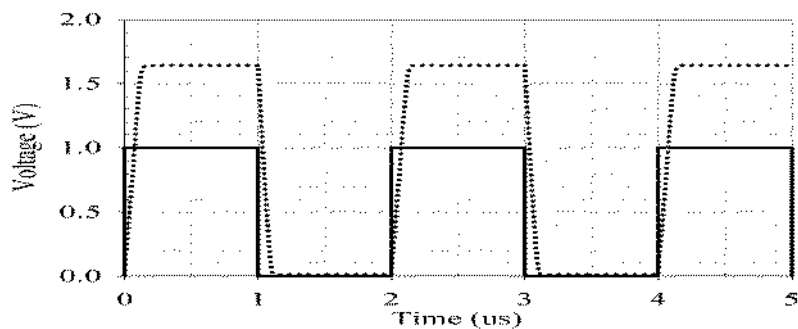
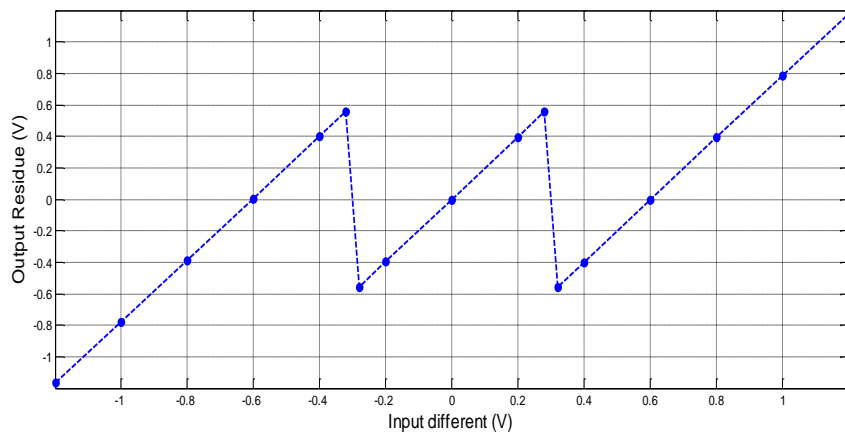


Figure 4 Transient analysis.

Figure 5 illustrates the result for implementation of the circuit in 1.5 bit per-stage pipeline ADC. The performances of the circuit are referring to the process information as tabulated in Table 2.

Table 2 : 1.5 bit per-stage pipeline ADC process information.

No	Vin	B1	B0	DAC Output	Residue output
1	$V_{in} > V_{ref}/4$	1	0	+Vref	$2V_{in} - V_{ref}$
2	$-V_{ref}/4 < V_{in} < V_{ref}/4$	0	1	0	$2V_{in}$
3	$V_{in} < -V_{ref}/4$	0	0	-Vref	$2V_{in} + V_{ref}$



**Figure 5** Implementation result.

The comparison for folded cascode op-amp performances between previous works is summarized as in Table 3. From the table, this circuit design attains low power consumption with smallest load capacitance; therefore the chip size can be reduced.

**Table 3** Folded cascode op-amp performances

No	Reference	[6]	[9]	This work
1	Technology ( $\mu\text{m}$ )	0.13	0.13	0.13
2	Voltage supply (V)	1.8	3.0	1.8
3	DC gain (dB)	91.5	94.9	64.5
4	Unity gain bandwidth (UGB)	714.5	414	133.1
5	Phase margin ( $^\circ$ )	62.0	82.3	68.4
6	Slew rate ( $\text{V}/\mu\text{s}$ )	NA	NA	22.6
7	Settling time (ns)	40.0	6.17	72.4
8	Power consumption (mW)	9.0	11.0	0.3
9	Load capacitance (pF)	7.5	2.0	1.0

## 5 Conclusion

The paper presents the design and implementation of operational amplifier with common-mode feedback circuit for pipeline ADC application using 0.13  $\mu\text{m}$  Silterra technology. The DC gain of the op-amp is obtained about 64.5 dB with unity gain bandwidth of 133.1MHz for a 1pF load and 68.4 degrees besides it consumes a low power consumption around 0.3 mW at 1.8 V voltage supply. The simulation result shows that the proposed design is suitable for pipeline ADC application.

## 6 References

- [1] Razavi, B. (2001). Design of Analog CMOS Integrated Circuits (International ed), Singapore, McGraw-Hill Higher Education.
- [2] Nageswarrao, D., Venkata Chalam, S. and Malleswara Rao V. (2010). Gain Boosted Telescopic OTA with 110dB Gain 1.8GHz UGF, International Journal of Electronic Engineering Research, Vol 2 No 2, 159-166.
- [3] Kant, S. and Sahu, O.P. (2012). Design of Low Voltage High Speed Operational Amplifier for Pipelined ADC in 90nm Standard CMOS Process, International Journal of Engineering Research & Technology, Vol 1 Issue 4, 1-5.

- [4] Ishak, I.S., Murad, S.A.Z. and Ahmad, M.F. (2014), Low Power Folded Cascode CMOS Operational Amplifier with Common Mode Feedback for Pipeline ADC, International Integrated Engineering Summit Conference.
- [5] Ab Rahim, S.A.E., Ismail, M.A., Rahim, A.I., Yahya, M.R. and Mat, A.F.A. (2010). A Wide Gain-Bandwidth CMOS Fully-Differential Folded Cascode Amplifier, International Conference on Electronic Devices, Systems and Applications, 165-168.
- [6] Liu, X. and McDonald J.F. (2012). Design of Single-Stage Folded Cascode Gain Boost Amplifier for 14bit 12.5 Ms/S Pipelined Analog-to-Digital Converter, IEEE-ICSE, 622-626.
- [7] Gu, W. and Gao, W. (2012). Design of OTA with Common mode Drain and Folded Cascode Used in ADC, World Academy of Science, Engineering and Technology, Vol 67.
- [8] Ahmad, M.F., Murad, S.A.Z., Shahimim, M.M., Rais, S.A.A. and Hasan, A.F (2014). Modified CMFB Circuit with Enhanced Accuracy for Data Converter Application, Applied Mechanics and Materials, Vol 446-447, 992-996.
- [9] Ab Rahim, S.A.E and Azmi, I.M. (2011). A CMOS Single Stage Fully Differential Folded Cascode Amplifier Employing Gain Boosting Technique, International Symposium on Integrated Circuit, 234- 237.



## EEG Signal Identification Based on Regression Coefficients Analysis Using BackPropagation for Brain Computer Interface

<sup>1</sup>Hindarto, <sup>2</sup>Izza Anshory, <sup>3</sup>Sumarno

<sup>1</sup>Department of Informatics, Muhammadiyah University of Sidoarjo, Sidoarjo, Indonesia

Email : [hindarto@umsida.ac.id](mailto:hindarto@umsida.ac.id)

<sup>2</sup>Department of Electronic, Muhammadiyah University of Sidoarjo, Sidoarjo, Indonesia

Email : [izzaanshory@umsida.ac.id](mailto:izzaanshory@umsida.ac.id)

<sup>3</sup>Department of Informatics, Muhammadiyah University of Sidoarjo, Sidoarjo, Indonesia

Email : [Sumarno@umsida.ac.id](mailto:Sumarno@umsida.ac.id)

### *Abstract*

ElectroEncephaloGraph (EEG) is an instrument to measure the electrical activity in the brain; furthermore, in the broader sense, this can be used as a means to detect patterns or imagination of a person's mind. This research is aimed to describe the identification of EEG Signal based brain computer interface (BCI) by segmenting it into 2 different classes. For this class segmentation, we introduce a method that combines Regression Coefficients via the BackPropagation Neural Network. The Regression Coefficients and specific energy are used to extract the EEG features of EEG signal data; from which BackPropagation is then used to identify the result of the process. The research finding reveals that from 561 tested data signal file, it can be figured out that the identification of the signal is 95% of the accuracy rate. The results show that in comparison with other current identification, the algorithm proposed here in can improve recognition rates.

**Keywords :** *Regression, BackPropagation, EEG signals, BCI, Brain.*

### **1. Introduction**

In 1929, a German psychiatrist, named Hans Berger, cited that it was possible to record a weak electric current occurred in the brain, without either necessarily opening the skull, or drawing on the paper. Berger named this new format as the recording of the ElectroEncephaloGraph (EEG). EEG signal for one person to another is varied due to some influencing factors namely mental condition, frequency and amplitude changes of alpha rhythm patterns of every individual thought in response to stimuli received by the brain.

EEG signals can be found by using electrodes attached to the head. The signal voltage ranges from 2 to 200 $\mu$ V, but generally 50  $\mu$ V. Frequency varies depending on the behavior. The average of EEG frequencies extends from 0.1Hz to 100Hz, but it sometimes ranges from 0.5Hz to 70Hz. Variations of EEG signals emerge when associated with the frequency and amplitude influence diagnostics. EEG frequency can be classified into five parts for EEG analysis, namely: Delta ( $\delta$ ) (0.5 to 4) Hz, Theta ( $\theta$ ) (4-8) Hz, Alpha ( $\alpha$ ) (8-13) Hz, Beta( $\beta$ ) (13-22)

Hz and gamma( $\gamma$ ) (22 - 30)Hz. A BCI allows a person to communicate or control the external world without using the brain's normal output pathways of peripheral nerves and muscles [1]. Brain Computer Interface (BCI) research at the Wadsworth Center has focused primarily on using EEG rhythms recorded from the scalp over sensorimotor cortex to control cursor movement in one or two dimensions [2]. A system that uses the human ability to control a video game on a mobile device using EEG Mu rhythms [3].

There have been identified some relevant former studies that have employed EEG signals of BCI. One of the applications of is the application of Adaptive Neuro Fuzzy Inference System (ANFIS) model for classification of EEG signals. The decision making from such application is performed in two stages: feature extraction using the Wavelet Transform (WT) and the ANFIS trained or investigated using BackPropagation Gradient Descent method in combination of the Least Squares method. In the applications, detailed classifications derived from set A (healthy volunteer, eyes open), set B (healthy volunteer, eyes closed), set C (seizure-free intervals of five patients from hippocampal formation of opposite hemisphere), set D (seizure-free intervals of five patients from epileptogenic zone), and set E (epileptic seizure segments) are performed [4]. Prediction of drowsiness level is reported.  $\delta$ ,  $\theta$ ,  $\alpha$ , and  $\beta$  sub-frequencies of the EEG signals are extracted by using Wavelet Transform. The Wavelet Spectra of EEG signals is used as an input to Artificial Neural Networks that could be used to discriminate alert, drowsy and sleeping states. The accuracy of the ANN is  $96 \pm 3\%$  alert,  $95 \pm 4\%$  drowsy and  $94 \pm 5\%$  sleeping state[5].

Besides the above research, there are other similar researches which make use of the samples of the same data taken from the data sets from BCI Competition 2003-Data Set Ia. They are among others:

BCI Competition 2003—Data Set Ia: Combining Gamma-Band Power With Slow Cortical Potentials, the study is aimed to improve Single-Trial Classification of EEG Signals. In this study, a four-channel (channel 1, channel 2, channel 4 and channel 6), and four features (two from the flat - flat from SPC and two of Gamma Band Power) are employed. The above research results figure out the classification of 88.7% [6]. Then other research makes used of EEG Recognition Based on Multiple Types of Information by Using Wavelet Packet Transform and Neural Networks. In this study, two channels (channel 4 and channel 6) and four features by combining Slow Cortical Potentials (SCPs) and Wavelet Packet Transform are employed and shows the results from the classification of 91.47% [7]. The other research involving the same data from EEG feature extraction based on Wavelet Packet Decomposition for BCI employs six channels (channel 1, channel 2, channel 3, channel 4, channel 5 and channel 6) and take 17 (seventeen) features and Neural Network for classification process. From which, the results derive the classification of 90.80% [8]. The next is a study assessing features for EEG signal categorization. In this study, six-channels (channel 1, channel 2, channel 3, channel 4, channel 5 and channel 6) and seven features (RMS, Spectral Centroid, bandwidth, Zero Crossing Rate, Spectral Roll-off Frequency, Energy Band Spectral Magnitude Ratios and Delta) of a Bayesian are employed in the classification process and derive a result in the classification of 90.44% [9]. A Polynomial Fitting and k-NN based approach are aimed for improving classification of motor imagery BCI data. In this study, one channel (channel 1) as test data is used and the second feature from the Polynomial Fitting (the value of h and the coefficient b) and k-NN are taken for a classification process; and it yields a results from the classification of 92.15% [10]. Another research is aimed

for identification of EEG signal to move the cursor using Backpropagation method. Researcher describes the application of BackPropagation Neural Networks as classification and sampling technique for feature extraction of wave form signal EEG. The result obtained is for the classification of this signal is 80 % [11].

All the above reseaches employ quite varied channels and features so that they require more processes for identification. Unlike the prior researches, the present research attempts to invole one channel and one feature so that the process of the identification could be more simple; therefore, in this study, the researchers present a method to improve the identification of BCI data using only one Electrode (single channel) and a feature that is used. Researchers plan to do identification cursor movement up and down using a BCI based on the thoughts of the human brain using EEG to take data from BCI competition 2003 data set Ia. Regression as feature and identification the feature data using the BackPropagation.

## **2. Materials And Methods**

### **2.1 Data Set Description**

The Data EEG chosen for experiments is the BCI competition 2003 data set Ia, which was taken from a single healthy subject at the University of Tuebingen, Germany. The subject was asked to move a cursor up and down on a computer screen, while his Cortical Potentials were taken. During the recording, the subject received visual feedback of his Slow Cortical Potentials (Cz-Mastoids). Cortical positivity led to a downward movement of the cursor on the screen. Cortical negativity led to an upward movement of the cursor. Each trial lasted in 6s.

During every trial, the task was visually presented by a highlighted goal at either the top or bottom of the screen to indicate negativity or positivity from second 0.5 until the end of the trial. The visual feedback was presented from second 2 to second 5.5. Only this 3.5 second interval of every trial is provided for training and testing. The sampling rate of 256 Hz and the recording length of 3.5s results in 896 samples per channel for every trial. In trained or investigated data, 268 trials were recorded on two different days and mixed randomly. 168 of the overall 268 trials origin from day 1, the remaining 100 trials from day 2. The 2-D Matrices Traindata\_0.txt and Traindata\_1.txt contain data of 135 trials belonging to class 0 and 133 trials belonging to class 1. The matrix dimensions are 135x5377 and 133x5377. Every line of a matrix contains the data of one trial. The first column codes the class of the trial (0/1). The remaining columns contain the time samples of the 6 EEG channels. This starts with 896 samples from channel 1 and ends with 896 samples from channel 6. In test data, This 2-D matrix has the dimension 293x5376 and contains 293 trials of test data. Every trial was recorded at the second day and belongs to either class 0 or class 1. The matrix has nearly the same structure as the train data matrices except for the missing class tag. Thus, every line contains 6 times 896 samples [12][13].

Measurements were taken by using Computer Boards PCIM-DAS1602/16 bit. The EEG recordings were at a sampling rate of 256 S/s, Amplitude range: +/-1000  $\mu$ V.

### **2.2 Regression**

Simple Regression

The Simplest Linear model involves only one independent variable and states that the true mean of the dependent variable changes at a constant rate as the value of the independent variable increases or decreases. Thus, the functional relationship between the true mean of  $Y_i$ , denoted by  $\varepsilon(Y_i)$ , and  $X_i$  is the equation (1) of a straight line:

$$\varepsilon(Y_i) = \beta_0 + \beta_1 \cdot X_i \dots\dots\dots (1)$$

$\beta_0$  is the intercept, the value of  $\varepsilon(Y_i)$  when  $X = 0$ , and  $\beta_1$  is the slope of the line, the rate of change in  $\varepsilon(Y_i)$  per unit change in  $X$ . The observations on the dependent variable  $Y_i$  are assumed to be random observations from populations of random variables with the mean of each population given by  $\varepsilon(Y_i)$ . The deviation of an observation  $Y_i$  from its population mean  $\varepsilon(Y_i)$  is taken into account by adding a random error  $I$  to give the statistical model that is defined as equation (2) :

$$Y_i = \beta_0 + \beta_1 \cdot X_i + e_i \dots\dots\dots (2)$$

The subscript  $i$  indicates the particular observational unit,  $i = 1, 2, \dots, n$ . The  $X_i$  is the observations on the independent variable and is assumed to be measured without error. That is, the observed values of  $X$  are assumed to be a set of known constants. The  $Y_i$  and  $X_i$  are paired observations; both are measured on every observational unit [14][15].

Simple linear Regression or Regression Order 1

The general form of the linear equation, can be written as equation (3) :

$$y = ax + bx \dots\dots\dots (3)$$

Where :

- a = Slope of the curve a straight line
- b = Intercept curve with 'ordinate' or vertical axis

Regression is meant here is the quest constant prices of  $a$  and  $b$  based on a row of data (number or  $xy$  data pairs as  $N$  pieces).

Regression Order 2

Quadratic or Parabolic Equations have the general form can be written as equation (4) :

$$y = a^2x + bx + c \dots\dots\dots (4)$$

Regression is meant here is the quest constant prices  $a$ ,  $b$  and  $c$  based on the given data set (note: the amount or  $xy$  data pairs as  $N$  pieces!).

Regression Order 3

Cube or third order Regression equations has the general form can be written as equation (5) :

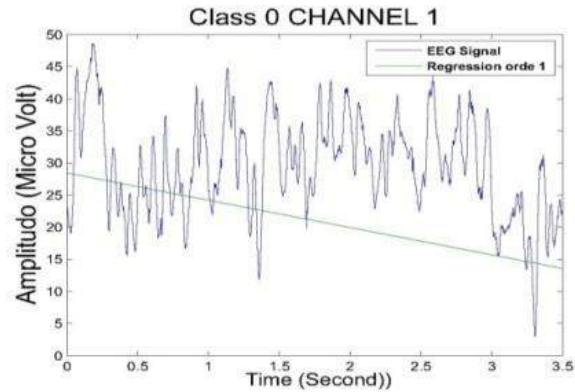
$$y = a_3^3x + b_2^2x + c_1x + d_0 \dots\dots\dots (5)$$

Regression is meant here is the search for the prices of  $d_0$  through  $a_3$  parameter based on a given set of data (note: data pairs  $N$   $xy$  are always numbered pieces!).

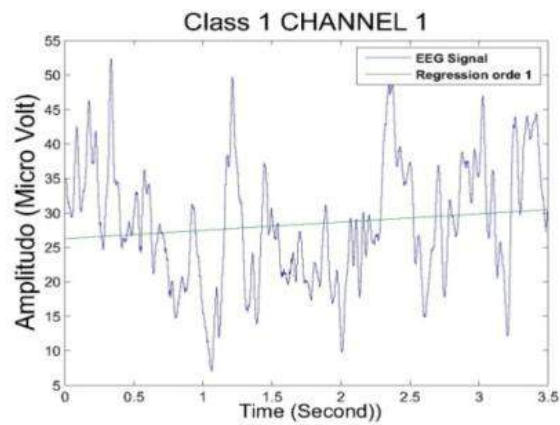
**3. Features Extraction Using Regression Methods**

Regression Order 1

In this research, the EEG signal data is processed using Regression Order 1. The process obtains a coefficient of Regression equation order 1 that is value a and b. Coefficients a and b are used as a feature of the EEG signal. Figure 1 is an EEG signal class 0 and class 1 of channel 1 for the Regression Order 1.



(a)

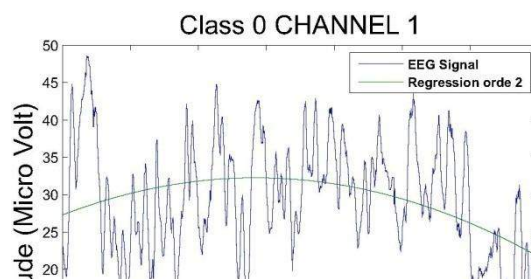


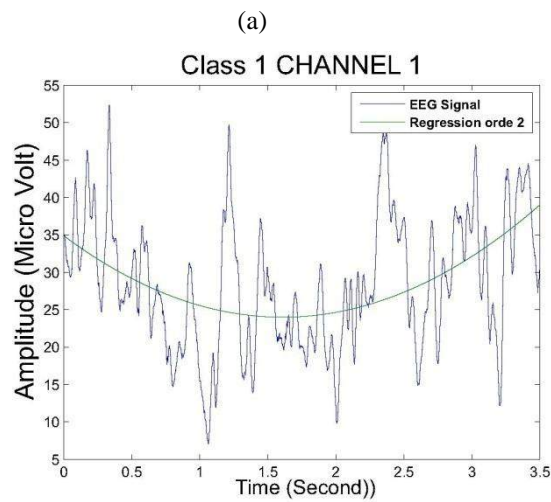
(b)

Figure 1. EEG signal data and the results of Regression Order 1 (a) class 0 to move up cursor ; (b) class 1 to move down cursor

#### Regression Order 2

Similar to Regression Order 1, the Regression Order 2 will get value Coefficients of Regression equation order 2 consisting of the values of a, b and c. Coefficients values a, b and c are used as a feature of the EEG signal. In Figure 2, it shows that the results of the Regression Order 2 has acurved shape down to class 1 and curved upwards to class 0.





(b)

Figure2.EEG signal data and the results of Regression Order 2 (a) class 0 to curved shape down ; (b) class 1 to curved upwards

### Regression Order 3

Identically to Regression Order 1 and 2, the Regression Order 3 obtains Coefficient values Regression equation order 3 which consists of the values of a, b, c and d. Coefficient a, b, c, d of the Regression Order 3 is used as a feature of the EEG signal.

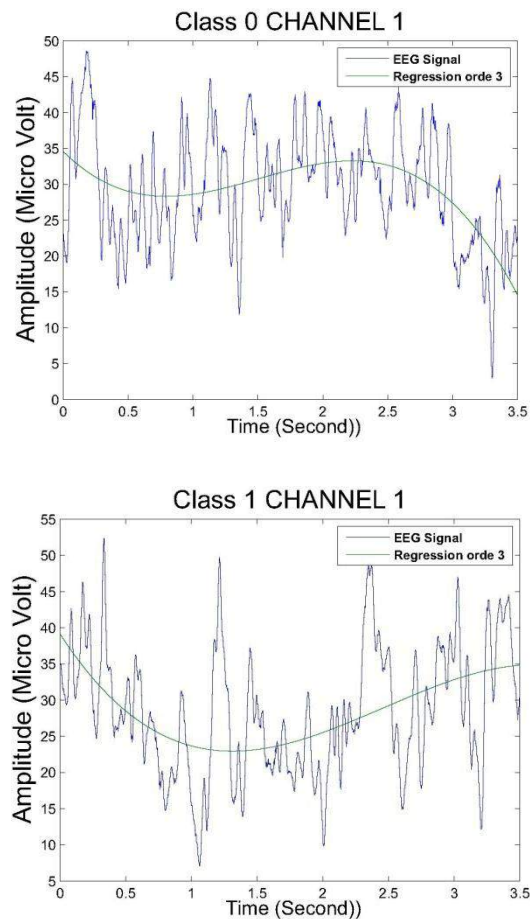


Figure 3. Results of EEG signals and result of Regression Order 3.

In Figure 3 shows that the results of the Regression Order 3 has the form following the pattern of EEG signal for class 0 and class 1.

#### 4. Identification using Neural Network BackPropagation

The BackPropagation network is a multilayer feed forward Neural Network consisting of an input layer with nodes representing input variables to the problem, an output layer with nodes representing the dependent variables and one or more hidden layers containing nodes to help capture the nonlinearity in the data. In this research, the BackPropagation architecture is composed one hidden layer, two hidden layers and three hidden layers with a Coefficient Regression as an input of the EEG signal.

In the process of identification with the first Neural Network training process is done to obtain the best weight value of the smallest error value on the acquisition target of the desired output. In the process of mapping done on EEG signal identification of class 0 (imagine the cursor movement up) and class 1 (imagine the cursor movement down) based on the value of the weight that has been gained in the training process.

## 5. RESULT

In this research, Coefficient Regression is employed to extract features from EEG signal data and then for identification, a BackPropagation method is employed to analyze the system that has been designed with using the method as described in materials and methods

### A. EEG Signal Data

Data set BCI Competition 2003 consists of class 0 (move cursor up) and class1 (move cursor down), each class consists of data training and data testing. Figure 5 is one of the EEG signal data taken from subjects channel 1 for cursor movement is the movement of the up cursor (class 0) and move the down cursor (class 1).

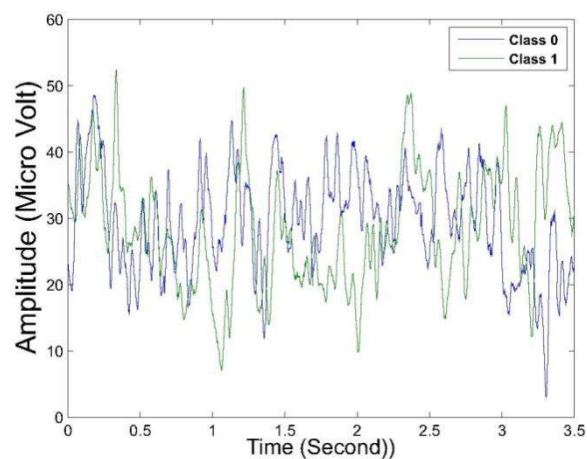


Figure 5. EEG signal

channel 1 of class 0

and class 1

### B. Regression Method

EEG signals that have been selected based on class 0 (up cursor) and class 1(down cursor) performed the Regression, each signal is processed using the method of Regression and each signal is obtained Coefficient Regression. Results of the Regression Order 1of the equation  $y= a+bx$ , as illustrated in figure 6.

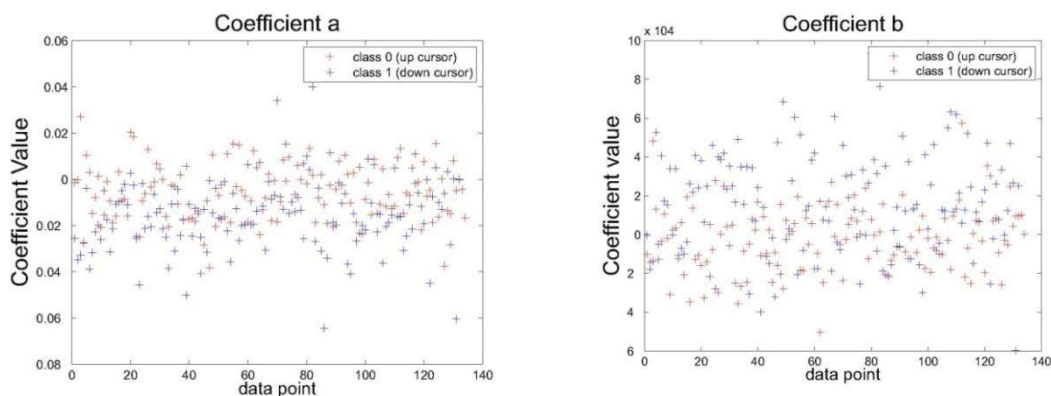


Figure 6. The results of the Regression Order 1are Coefficients a and b value taken from the Training data.



Data Input from the Regression Coefficients is used as an input in identification process, in which it uses method BackPropagation Neural Network .There are two stages in the process of identification, namely learning and mapping. In the process of learning, it uses learning rate parameter 0.1 and error limited 0.01. The initial value is determined from random weight range -1 to 1.

To find the optimal parameters that produces the best performance of Neural Networks, it is used to adjust an assessment according to the scale Mean Squared Error (MSE) and a number of hidden unit nearly optimal value at the time of raining.

The results of the performance and the accuracy of identification can be shown in table 1.

Table 1. BackPropagation identification results using Regression coefficients as feature extraction.

Regression	Coefficients Regression	The level of	The level of	The level of
		accuracy (%)	accuracy (%)	accuracy (%)
		1 hidden layer	2 hidden layer	3 hidden layer
Order 1, $Y = ax + b$	a	89	89	89.5
	b	73.5	75	77
Order 2, $Y = ax^2 + bx + c$	a	95	95	95
	b	91	86.5	89.5
	c	85	81	84.5
Order 3, $Y = ax^3 + bx^2 + cx + d$	a	93.5	94	88
	b	84.5	83	82.5
	c	81.5	79	82
	d	89	91.5	84

In table 1 shows that identification using BackPropagation and feature extraction using Regression Order 2 of Coefficient b of Coefficient h produces a better accuracy rate has 95% accuracy rate.

## 6. CONCLUSIONS

This research is conducted to analyze the Regression Coefficients and specific energy of the time - frequency domain - Alpha-band are used to extract the EEG features of EEG signal data; from which BackPropagation is then used to identify the result of the process. EEG signal data is divided into two classes, namely class 0 for the up cursor and down cursor for class 1. 268 data files EEG signal for training and 293 data files EEG signals for testing. At the time of identification into two classes, there are 561 EEG signal data (combined data from training and testing) data file EEG signals. In Table 1 shows that the Regression Coefficients of order 1 to have an accuracy rate of 89.5% for the 3 hidden layer. The Regression coefficients of order 2 to have an accuracy rate of 95% for 1, 2 or 3 hidden layers. The Regression Coefficients of order 3 to have an accuracy rate of 94% for 2 hidden layer. The accuracy of identification of BackPropagation is considered fairly good performance, arriving

at the 95% level by using Regression order 2 of Coefficients b. The challenge for future researchers is how to examine the appropriate technique for feature extraction of EEG signals. The obtained result will be compared with the methods that have been studied.

### Journal Paper Reference

- [1] J. R. Wolpaw, N. Birbaumer, D. J. McFarland, G. Pfurtscheller, and T. M. Vaughan, “*Brain computer interfaces for communication and control*”, *Clinical Neurophysiology*, 113(6):767(791), 2002.
- [2] T. M. Vaughan, W. J. Heetderks, L. J. Trejo, W. Z. Rymer, M. Weinrich, M. M. Moore, A. Kubler, B. H. Dobkin, N. Birbaumer, E. Donchin, E. W. Wolpaw, and J. R. Wolpaw, “*Brain-computer interface technology*”, a review of the second international meeting. *IEEE Transactions on Neural Systems and Rehabilitation Engineering*, 11(2):94(109), 2003.
- [3] Payam Aghaei Pour, Tauseef Gulrez, Omar AlZoubi, Gaetano Gargiulo and Rafael A. Calvo, “*Brain-Computer Interface: Next Generation Thought Controlled Distributed Video Game Development Platform*”, *IEEE Symposium on Computational Intelligence and Games (CIG)*, 2008.
- [4] Inan Güler, Elif Derya Ubeyli, “*Adaptive neuro-fuzzy inference system for classification*”. *Journal of Neuroscience Methods* doi : 10.1016/j.jneumeth.2005.04.013, 2005.
- [5] M. Kemal Kiyimik, Mehmet Akin, Abdulhamit Subasi, “*Automatic recognition of alertness level by using wavelet transform and artificial neural network*”. *Journal of Neuroscience Methods* 139 (2004) 231–240, 2004.
- [6] Mensh, B.D., Werfel, J., Seung, H.S., “*BCI competition 2003—Data set Ia: Combining gamma-band power with slow cortical potentials to improve single-trial classification of electroencephalographic signals*”. *IEEE Trans. Biomed. Eng.* 51, 1052–1056, 2004.
- [7] Baojun Wang; Liu Jun; Jing Bai; Le Peng; Yan Li; Guang Li, “*EEG Recognition Based on Multiple Types of Information by Using Wavelet Packet Transform and Neural Networks*”. [Engineering in Medicine and Biology Society, 2005. IEEE-EMBS 2005. 27th Annual International Conference of the](#) Issue On page(s): 5377 – 5380, Date: 17-18 Jan. 2006
- [8] Wu Ting, Yan Guo-zheng, Yang Bang-hua, Sun Hong, “*EEG feature extraction based on wavelet packet decomposition for brain computer interface*”, 0263-2241/ see front matter, Elsevier Ltd. All rights reserved. doi: 10.1016/j.measurement, 2007.
- [9] Shiliang Sun; Changshui Zhang, “*Assessing features for electroencephalographic signal categorization*”. [Acoustics, Speech, and Signal Processing, 2005. Proceedings. \(ICASSP '05\). IEEE International Conference on](#) On page(s): v/417 - v/420 Vol. 5, 2005.
- [10] Temel Kayikcioglu, Onder Aydemir, “*A polynomial fitting and k-NN based approach for improving classification of motor imagery BCI data*”. *Pattern Recognition Letters* 31 (2010) 1207–1215, 2010.
- [11] Hindarto, Moch. Hariadi, Mauridhi hery P, “*Identification of Electroencephalograph signal to move the cursor using back propagation method*”. *The 1<sup>st</sup> International conference on Information System for business competitiveness (ICISBC)*. ISBN : 978-979-097-198-1 Page : 260-263, 2011.

- [12] Benjamin Blankertz, Klaus-Robert Müller, Gabriel Curio, Theresa M. Vaughan, Gerwin Schalk, Jonathan R. Wolpaw, Alois Schlögl, Christa Neuper, Gert Pfurtscheller, Thilo Hinterberger, Michael Schröder, and Niels Birbaumer. The BCI competition 2003: Progress and perspectives in detection and discrimination of EEG single trials. *IEEE Trans. Biomed. Eng.*, 51(6):1044-1051, 2004.
- [13] Thilo Hinterberger, Stefan Schmidt, Nicola Neumann, Jürgen Mellinger, Benjamin Blankertz, Gabriel Curio, and Niels Birbaumer. Brain-Computer Communication and Slow Cortical Potentials. Hinterberger et al.: BCI and SCP, TBME-00279-2003.

### **Book Reference**

- [14] John O.Rawlings, Sastry G. Pantula, David A.Dickey, “Applied Regression Analysis : A Research Tool, Second Edition”. Ch 1.1 pp.2, 1998.
- [15] Simple Regession, Review O F. Sts 414 Analisis Of Variance (Anova). [http:// www.unaab.edu.ng /attachments / 477\\_STS%20414%20ANALYSIS%20OF%20VARIANCE.pdf](http://www.unaab.edu.ng/attachments/477_STS%20414%20ANALYSIS%20OF%20VARIANCE.pdf)

## CONFORMITY TOOL FOR LAND EVALUATION IN ANDROID MOBILE APPLICATION

Supli Effendi Rahim<sup>1)</sup>, Ahmad Affandi Supli<sup>2)</sup>, Norshuhada Shiratuddin<sup>3)</sup>,  
Nurhayati<sup>4)</sup> & Zulkifli. S. Mukti<sup>5)</sup>

- <sup>1)</sup>Agrotechnology Department, Agriculture Faculty, University of Palembang, Palembang Indonesia, [sup\\_effendi@yahoo.co.id](mailto:sup_effendi@yahoo.co.id), 62-711-440650.  
<sup>2)</sup>Master Multi-media student at Faculty of Computer Science, UUM Kedah Malaysia, [ahmad\\_affandi123@yahoo.com](mailto:ahmad_affandi123@yahoo.com), 60-17-5417422  
<sup>3)</sup>Norshuhada Shiratudin, School of Multimedia communication and technology, University of Malaysia Utara, Kedah, Malaysia, [shuhada@uum.edu.my](mailto:shuhada@uum.edu.my), 60-9286821  
<sup>4)</sup>Agrotechnology Department, Agriculture faculty. University of Sriwijaya, Indralaya, Ogan Ilir, South Sumatra Indonesia, [nurhayatidamiri@yahoo.co.id](mailto:nurhayatidamiri@yahoo.co.id), 62-711-441140.  
<sup>5)</sup>Zulkifli S. Mukti, Faculty of Law, University of Palembang, Palembang Indonesia, [julmukti@gmail.com](mailto:julmukti@gmail.com), 62-711-440650

### ABSTRACT

In order to evaluate a land as a potential place for agriculture, it is imperative to consider many facets to determine its suitability. In doing so, there is a famous theory as assessment tool to evaluate it. The theory is from food agricultural organization (FAO) framework that has been widely used to evaluate suitability of land. By referring to this theory, the researcher or land users can analyze their land, whether it is suitable or not to grow some particular plants. However, the assessment is so difficult in terms of understanding. This is due to some of researcher's still use manual assessment referring to the FAO framework, and as a result the implementation to achieve the better results is still not effective. Therefore, having a better system, which is easy to understand and simple, is really vital. Nevertheless, the development of technology in mobile applications is available nowadays to suggest in many area of solving problem. The authors then suggest the solution by transforming the theory of FAO into smart mobile application as conformity tool. The novelty of this application is designed in terms of simplicity of language for each variable (factor) and also by utilizing expert system theory called Rule Based System (RBS) algorithm. By utilizing the simplicity of language and also the patterns searching method from RBS, the application is easier to understand and has been proved to be able to determine the suitability of land faster and effective. The suitability land in this study focuses on rubber, cocoa, and oil palm tree. The purposed idea in this application is intended to be useful for land users, farmers, companies, lecturers, students and government Officers. In the future the authors will evaluate the usefulness of application.

**Keywords:** *conformity tool, land evaluation, land suitability, android application*

### 1. INTRODUCTION

In Indonesia and in the world, tool or method for evaluating land use such as agricultural land and plantations have long been introduced by FAO [6] and Sehgal [13]. A number of soil quality variables have significant effect on plant growth and production [10; 14]. That is why in the the FAO framework for land evaluation, climate factors, soil physical and chemical factors, are included as considering factors for suitability assessment for a number of plants for plantation. Those factors were all considered when assessing the suitability of post-mining land for agricultural land as well as for plantation by workers such as Hermawan [9], Hermawan et al. [8]; Hermawan [10]. With this method a farmer or land users in a broad sense obtain clarity on the use of land to whether the land is suitable for rubber, oil palm, cocoa or for agriculture in the broader sense.

The existing evaluation methods for those lands are still manually conducted. A number of researchers have been reported to use this method in order to do land evaluation. For instances, Hermawan [10] and Agriculture faculty of Sriwijaya University team [3] assessed the suitability of coal mined lands in PT Bukit Asam Tanjung Enim and found that most of the land in the post-mining land reclamation of coal was suitable for agricultural crops in general. Rahim [12], Hermawan et al. [8], Hermawan [9] all evaluated

post-mining land at PT. Bukit Asam Tanjung Enim and stated the importance of various soil properties in the assessment of land suitability for some plantation crops.

However, the use of such land evaluation system is quite cumbersome and difficult to use by land users, including farmers' that have limited knowledge to read and apply the evaluation method. In other words, the method is less practical and effective especially when evaluating land suitability for a number of plantation crops especially for conducting a land evaluation for particular land [5].

In the current era, the availability of mobile applications is most prevalent around the world to allow users to more quickly and practically dealing with everyday problems [15]. Such application is not only practical and effective for land users but also very effective for teaching students as a computer-aided teaching program. Therefore, this article focuses the development of the mobile application as conformity tool for land suitability evaluation. This application is equipped with a very useful program, especially for landowners and land users such as farmers, companies, government officials, students of higher education in agricultural sciences and other land users. This paper tries to describe the use of mobile application as a tool for land evaluation which is more practical and fast.

This study foresees the need to improvise the land evaluation making styles among farmers and other land users as well as among government officers by implementing the conformity tool for land evaluation. The tool is able to offer recommendations which make a clear cut land suitability classifications which give a proper classification of the land suitability and give a clear limiting factors which need to be addressed if the land is utilized.

## **2. THE THEORY OF LAND EVALUATION BY FAO**

The criteria for land suitability for plantation crops are presented in Table 1. This table as mentioned explanation in introduction section cannot be used directly by farmers in order to evaluate the land. Therefore, this table will be created in a simpler language in the application so it can be understood easily by land users such as farmers. Simplification can be seen in screen shot section.

From the table:

1. The Order of S and N. S Order indicates that the land is evaluated according to use for a particular use within a limited time period. Order N indicates that the land is not suitable for a particular use.
2. Classes S1 - S3 and N1 - N2. Class S1 is a very appropriate land, land that is not a limiting factor or only a few minor limiting factors. S1 - 2 is suitable land, land units with light and the limiting factor is not more than one medium divider that can be improved. S2 is a land with moderate suitability, land units that have more than four light limiting factor and not more than three- limiting medium ( moderate ) that can be improved. S3 is less suitable land, land units with more than three limiting factors limiting medium (moderate) and or no more than a severe limiting factor. N1 is not appropriate potential land, land units that have very severe limiting factors that can be improved.
3. Sub - class declares the type of the limiting factors in each class. In one sub - class can have more than one limiting factor.
4. Units are land suitability unit level is further division of the sub -class based on the magnitude of the limiting factors.

In other words, the variables that exist in the table will be changed into the form of questions to extract an answer from the user. However, not all variables are displayed in the application. This consideration is due to several variables cannot be physically measured, because the number of variables is relatively equal in value between regions or soil types. For example, the annual rainfall generally be in the range of above 2000 mm, the air temperature is above 25 °C.

There are a number of variables that will be displayed in the application. The use of simple language is included in the application. In other words, each of variables is packaged into a question, which has some details (explanation) so that users can understand the variable and give an answer. Before displaying some screenshots of the application, the following section explains on how the development of application is constructed.

**Table 1.** Criteria for land suitability classes for plantation crops

No.	Land characteristics	Limiting factor and land suitability classes			
		0	1	2	3
		S1	S2	S3	N1
1	Topography of Slope (%)	0-5	5-8	8-15	15-35
2	Flood hazard	FO	F1	F2	F3
3	Drainage Class	Good	Moderate	Poor	Very poor
4	Texture	CISL, SCIL	SCIL	SL,S(f)L	SL,SCI, S(f)
5	Effective Depth (cm)	200-150	200-100	10-50	<50
6	- NPK average (kg/ha)	MMM	MLL	LML	-
7	Thickness of peat (cm)	50-100	101-200	201-300	>300
8	Depth of pyrite (cm)	>150	101-150	51-100	< 50
9	pH for rubber and oil palm	>5.0	4.2-5.0	3.5-4.1	<3.5
10	pH for cocoa	6.5-6.0	5.9-5.5	5.4-5.0	<5.0

**Notes:**

FO (none), F1 (light), F2 (moderate), F2 (moderate-heavy), CISL (clay sandy loam), SCIL (sandy clay loam), SL (sandy loam), SCI (sandy clay), S (sand) MMM (N, P and K moderate), MLL (N moderate, P and K low), LML (N low, P Moderate, K low).

### 3. PREPARE YOUR PAPER BEFORE STYLING

#### 1. *Ruled Based System*

Rule base system (RBS) is chosen as an expert system algorithm in attempting to see the pattern for determining appropriate decisions, so that the suitability towards particular land can be decided properly. The reason why this theory is selected is due to this approach could incorporate the pattern from all gathering rules which refer to the table as matching patterns and lead to conclusion. To understand, RBS is an approach of artificial intelligent that utilizes “if-then” statement for its reasoning [7]. The “if” statement here means that the certain condition is settled, whereby “then” statement means when the condition is fulfilled the action is fired or executed.

Particularly, each rule has this “if-then” statement that is constructed based on literature review that has been discussed earlier. The result of fired rule is either able to execute the other rules that is correspondently related or directly results on the end of conclusion [2; 4]. The point is that, among the bunch of rules, only several rules that are fired that make patterns to achieve particular goal or conclusion. This is due to the fired rules are based on what kind of facts that are given beforehand, and then the reasoning will be processed to find a way until all the related rules are executed.

The reasoning of RBS itself has two types of inferences, namely forward chaining and backward chaining [7]. Forward chaining is a searching method that begins from bunch of facts in order to reach provided conclusion [11]. This is method also known as data-driven, which means searching from data to conclusion. Meanwhile, backward chaining is on the opposite way, starting from goal or conclusion to extract facts in the end. Another name is goal driven, means from goals to data. In this study, the authors choose forward chaining, because of the data comes from users that are being asked, then the system will automatically infer to find the appropriate decision.

It is therefore, the design of the forward chaining rules must be depicted into visualization graph, so that what kind of related rules can be seen and also the interpretation into algorithm could be performed properly. However, it is crucial to construct all related rules in this study, so that the implications towards it could be derived onward.

## **2. The Rules in Conformity Tool for Land Evaluation**

As discussed before, the rules in this study are related to table 1 above, which is a table criterion for land suitability classes. In this study, there are three part processes that are separated based on their own function. First part has function to decide the maximum class of data from number 1 until number 8 in the table 1. Second part has function to decide the class for each pH in both cacao and (rubber and oil palm) tree in question number 9 and 10. The reason why the questions are divided into two parts will be explained later in this section. Third part is to compare the first and second part as it is integrated into producing some probabilities of decision.

The first part started by storing all the answers of user to be compared to the table 1. The starting point is that, as written in the theory of FAO [6], the decision of suitability is laid on the categorized classes, namely S1 (very suitable), S2 (suitable), S3 (slightly suitable), and N1 (not suitable). In other words, if all variables of user's answer contained in S1, meaning that it shows that the land is very suitable. However, if one of the values falls on class S2, then the judgment will be on S2 decision (suitable). Then again, despite of all values contain of S1 values but one of them is S3, the conclusion is on S3 (slightly suitable). Eventually, it is also applied on N1. The point, for all rules stated above, is that based on those rules, the maximum value determines the result of conclusion. To conclude, the order from maximum to minimum is N1, S3, S2, and S1. The rule is then the system is assigned to find the maximum class among data(s) from number 1 to 8 based on what user has answered. This maximum is stored as part1 variable to be compared later in part three of processes.

Next is the discussion of second part of the processes. As stated in table 1, the pH value is divided into two types, which are pH1 (rubber and oil palm) and pH2 (cocoa). As mentioned in section 2 in this paper, the questions are also constructed into simpler language. Therefore, this consideration has made the question for pH has been integrated into one question form and also has made this becomes separated part of processes due to avoiding ambiguous issue problem. This means instead of having 8 questions in two different question forms, the authors summarized pH into 6 questions in one question form. This aims to make simpler question, which is not ambiguous, towards users. The table 2 below depicts the relationship after forming into six states of questions.

**Table 2.** Constructed pH questions and its relation.

No	State of questions (pH)	suitability class for cacao	suitability class for rubber and oilpalm
1	6,5 – 6	S1	S1
2	5,9 – 5,5	S2	S1
3	5,4 – 5	S3	S1
4	4,9 – 4,2	N1	S2
5	4,1 – 3,5	N1	S3
6	< 3,5	N1	N1

The table 1 shows that even though the questions are summarized into six divisions, but the relationship still could be managed to be different rules in this study. Since the term pH itself divided into two classified plantation, which are cacao pH, rubber and oilpalm pH, then the results of this part will have both of them generated classes. These results are saved into two different variables that stored both result of pH value.

After all, the last step, third part, is to compare between the data from the first part and second part. The comparisons are to check the last probability of having another maximum class for each plant group (cacao plant (1), rubber and oil palm (2)). For instance, if the first part has stored maximum class in S2, while in second part the pH gives S3, then the last conclusion will be fallen to S3. However, as can be



seen in table 2, the probability of number three question has two classes, which are s3 (cacao) and s1 (rubber and oil palm). This means the comparison for both pH results have different filtration to result the last conclusion.

To conclude, all of these facets are considered to be bunch of facts (rules) that related each other to result particular decision of suitability for particular land. The next subsection shows the some user interfaces of the application.

#### 4. SCREENSHOT OF APPLICATION

The figures in this section display some user interface screen shots in the application. Figure 1 is the main user interface of the application, and then by clicking on the start button the user is guided to answer all related questions. As depicted below, the figures 2 to 7 show the questions that are elaborated to be more understandable by giving some explanation to users. As discussed previously in section B, there are two possibilities result form to be displayed. First is probability that the land is not suitable for any plantation. Second one shows the variety of answer in two categories of land suitability as focus in this study, which are suitability for cocoa tree and suitability for rubber and oil palm trees.

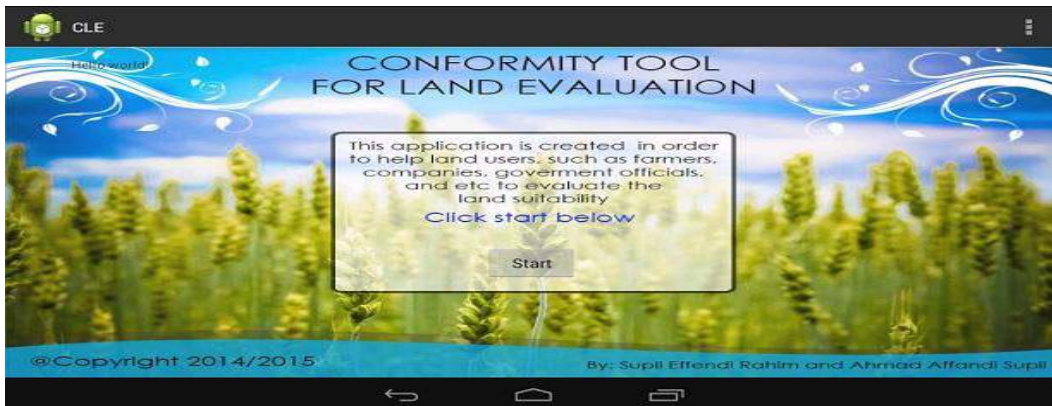


Figure 1. Main User Interface of Application

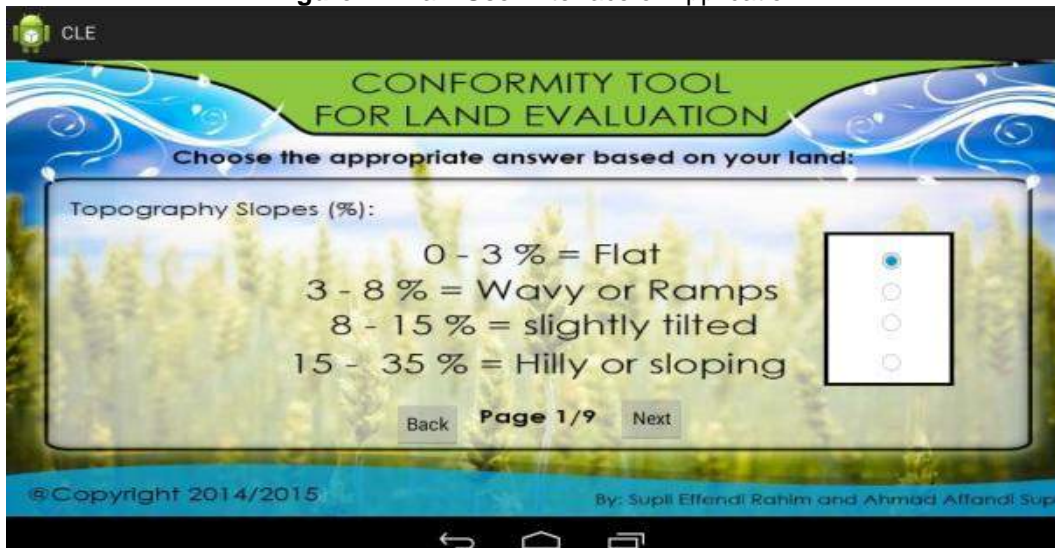


Figure 2. Topography of Slopes Variable



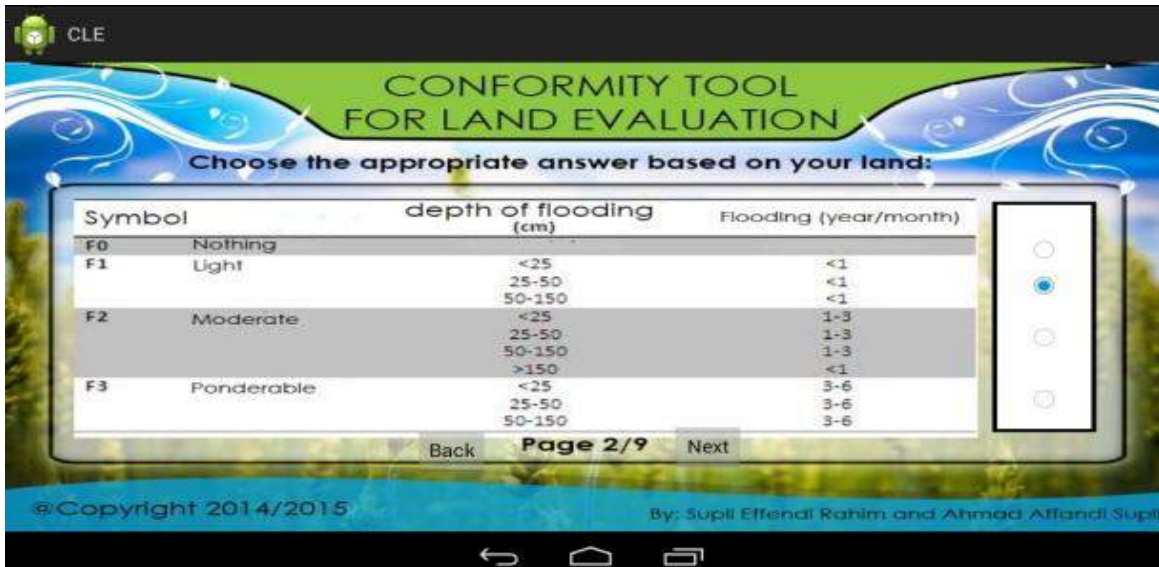


Figure 3. Flooding Variable

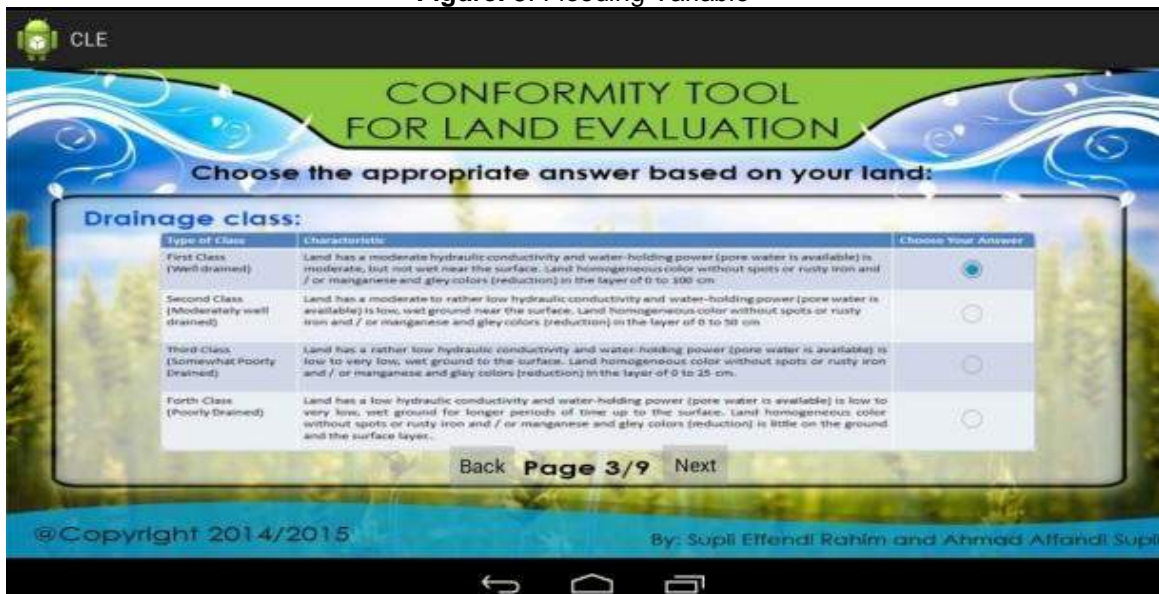


Figure 4. Drainage Class Variable



Figure. 5. Land Texture Variable

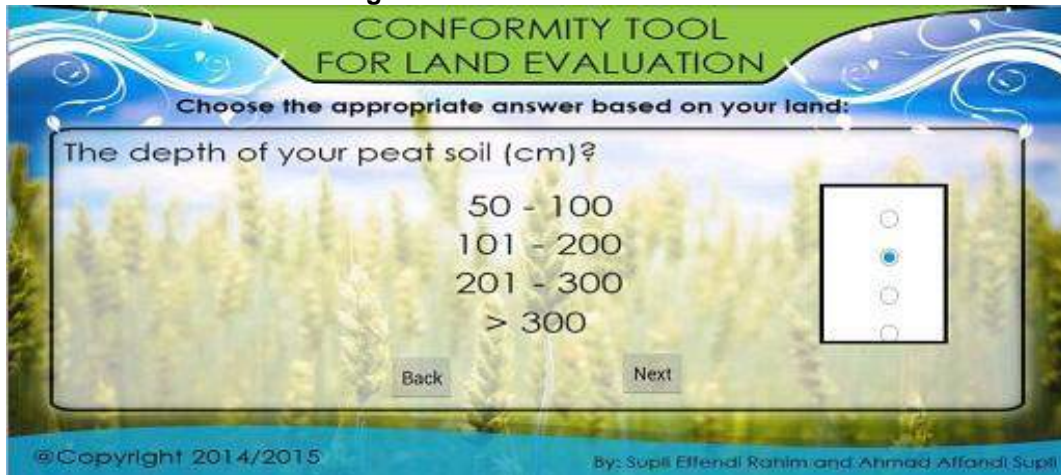


Figure. 6. Depth soil variable

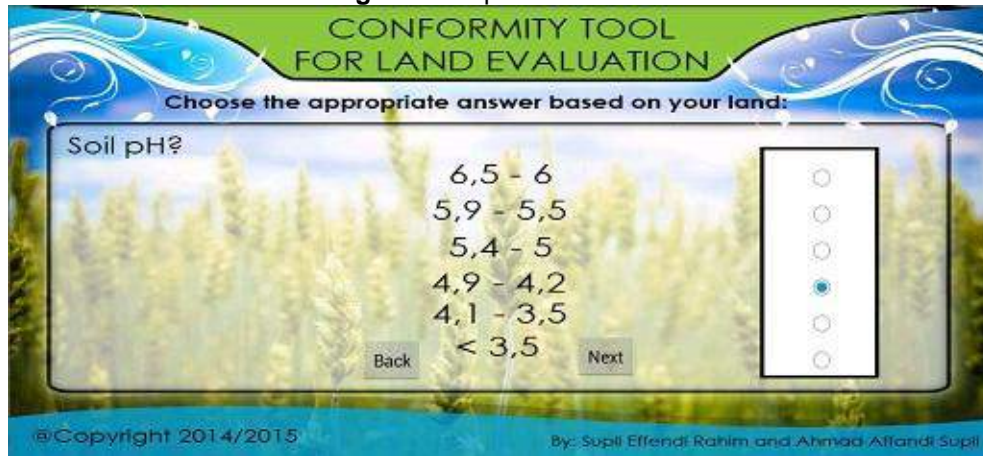


Figure. 7. Soil pH variable





**Figure 8.** Example of Decision Result



**Figure 9.** Example of Decision Result

## CONCLUSION

This is ongoing research that the authors have attempted to give a new solution by transforming the theory of FAO into smart mobile application as conformity tool as a replacement of manual land evaluation system. The novelty of this application is designed with simplicity of language for each variable (factor) and also by utilizing expert system theory called Rule Based System (RBS) algorithm. As a result, the application is much easier to be understood and also can automatically determine the suitability of land faster and effective. The suitability land in this study focuses on rubber, cocoa, and oil palm tree. The purposed idea in this application is intended to be useful for land users, farmers, companies, lecturers, students and government Officers. In the future, the authors will evaluate the usefulness of application. Moreover, it is suggested to enhance the coverage of the application for various land uses, such as agricultural plants, forestry, and aquaculture. The inclusion of real time climate data, as new factor in the table for the land evaluation, is also suggested.

## REFERENCES

- [1] [1] Aamodt, Agnar, & Plaza, Enric. (1994). Case-based reasoning: Foundational issues, methodological variations, and system approaches. *AI communications*, 7(1), 39-59.
- [2] [2] Akerkar, Rajendra, & Sajja, Priti. (2010). *Knowledge-based systems*: Jones & Bartlett Publishers.
- [3] [3] Agriculture faculty of Sriwijaya University team. 2006. Assessment of soil and vegetation conditions of land reclamation of post mining land of PT. Bukit Asam Tanjung Enim. Report of Cooperation in research between Agriculture Faculty, Sriwijaya University and PT. Bukit Asam Tanjung Enim, South Sumatra province, Indonesia
- [4] [4] Buchanan, Bruce G, & Shortliffe, Edward Hance. (1984). *Rule-based expert systems* (Vol. 3): Addison-Wesley Reading, MA.
- [5] [5] Djaenuddin, Df. 1995. Evaluasi lahan untuk arahan pengembangan komoditas alternatif dalam mendukung kegiatan agribisnis. Pusat Penelitian Tanah dan Agroklimat. Bogor.
- [6] [6] FAO. 1976. A Framework for Land Evaluation. Soil Resources Development and Conservation Service Land and Water Development Division Food and Agriculture Organization of the United

Nations Published by arrangement with the FOOD AND AGRICULTURE ORGANIZATION OF THE UNITED NATION.

- [7] [7] Hayes-Roth, Frederick. 1985. Rule-based systems. *Communications of the ACM*, 28(9), 921-932.
- [8] [8] Hermawan, B., Hasanuddin, B. Saleh and S.S.M. Rambe. 2000. Study of needs of fertilizer and water for specific locations of irrigation areas in Bengkulu province. Report of Cooperation for Research in Installation and Agricultural Technology assessment Bengkulu with Research Institute of Bengkulu University, Bengkulu, Indonesia.
- [9] [9] Hermawan, B. 2002. Soil physics. Research Institute UNIB Press, Bengkulu.
- [10] [10] Hermawan, B. 2011. Improving the quality of post-mining land through revegetation and its suitability classifications for agricultural food land. Proceeding of National Seminar on Agricultural Culture, Urgency and Strategy for controlling the land function change. Bengkulu 7 July 2011. ISBN 978-602-19247-0-9.
- [11] [11] Huang, Hao-Chen. (2009). Designing a knowledge-based system for strategic planning: A balanced scorecard perspective. *Expert Systems with Applications*, 36(1), 209-218.
- [12] [12] Rahim, SE. 2003. Soil erosion control for improvement of environmental condition. PT. Bumi Aksara publisher. Jakarta.
- [13] [13] Sehgal, J. 1996. Pedology concepts and applications. Kalyani Publ. Ludhiana, New Delhi.
- [14] [14] Taylor, M.D., N.D. Kim, R.B. Hill, and R. Chapman. 2010. A review of soil quality indicators and five key issues after 12 yr soil quality monitoring in the Waikato region. *Soil use and management* 26: 212-224.
- [15] [15] Unhelkar, Bhuvan, & Murugesan, San. (2010). The enterprise mobile applications development framework. *IT professional*, 12(3), 0033-0039.

## Cutting Process Analysis of Environmental Friendly Composites from Oil Palm Empty Fruit Bunch Fibers Using Rotary Saw Machine

<sup>1</sup>Andy Cahyaputra Arya, <sup>2</sup>Indra Surjati, <sup>3</sup>Rully Ario Dewanto Soeriaatmaja, <sup>4</sup>Dorina Hetharia, <sup>5</sup>Wensen

<sup>1, 2, 4, 5</sup>Faculty of Industrial Technology, Trisakti University

<sup>3</sup>Faculty of Art and Design, Trisakti University

Campus A, Jl. Kyai Tapa No. 1, Grogol, Jakarta 11440, Indonesia

### Abstract

The area of oil palm plantation in Indonesia for the past 7 years shows an increasing trend about 1.40 to 9.05 % per year. Along with the growing up crude palm oil (CPO) production the wastes generated (solid, liquid, gas) at palm oil mill increased as well. Empty fruit bunch of oil palm (EFB) is one of the solid waste (biomass). The fibers of EFB has the potential to be used as industrial raw material for composite. The natural fibers of EFB will be mixed with biodegradable adhesive based on starch from potato. Since the composite produced consists only of natural stuffs these are environmentally friendly and renewable. The processing stages are firstly the production of prepregs and finally the production of composites. The prepregs will be pressed by 180 °C temperature, 40 tons pressure, 30 minutes press duration. The finishing stage of composite is cutting of composite edge areas. The cutting process by using GUILLOTINE cutting machine showed good results. Since there is the limited budget for the research project, it is interesting to find out the cutting results by using other cutting machines such as rotary saw cutting machine where such machine is less expensive than Guillotine. The cutting results by using rotary machine showed that the results of chain saw cutting discs with Z = 100 is better than Z = 60 and Z = 80 where the surface results are smooth and gave less damage or less rejected results. The cost of electricity consumption of cutting composites using disc saws Z = 80 is most expensive because it needed longer cutting duration in comparison to Z = 100 and 60.

**Keywords:** *Environmental friendly composite, Fibers of Oil palm Empty Fruit Bunch, Guillotine, Rotary Saw Cutting machine.*

The Authors thank "Koordinasi Perguruan Tinggi Swasta Wilayah III, Kementerian Pendidikan dan Kebudayaan, Indonesia" for funding this research project "Riset Andalan Perguruan Tinggi dan Industri" (RAPID) with the title of "Pemanfaatan Serat Tandan Sawit sebagai Komponen Anti Peluru Kendaraan Patroli" for the research period: 2013-2015.

## 1 Introduction

The area of oil palm plantations in Indonesia for the past 7 years shows a growing trend by about 1.40-9.05% per year. According to the increasing area of oil palm plantations in 22 provinces in Indonesia during the years of 2007-2013 that the province of Riau is a province with the highest palm oil production and widest oil palm plantation, namely with the biggest area plantation by 1.92 million hectares in 2011, or 21.08% of the total area of oil palm plantations in Indonesia. In 2012, the total area of oil palm plantations in province of Riau is estimated by 1.94 million hectares. The increasing production of crude palm oil (CPO) was growing up parallel to the total increasing area of plantation by about 1.66 up to 10.25% from 2007 to 2013. In 2007, the production of CPO by 17.80 million tons increased to 24.00 million tons in 2011, in 2012 by 1.66% at 24.39 million tons and in 2013 by 3.18% with 25.17 million tons CPO production. **[1]**

Along with the increasing CPO production, the wastes which are generated at palm oil mill are increased as well, they are in forms of solid, liquid and gas wastes. The solid waste of Empty Fruit Bunch of Oil Palm (EFB) has the potential to be used as industrial raw materials by gaining its natural fibers. This natural fiber can be used as a basic stuff for producing bio composites by mixing it with natural adhesive based from potato and finally will be produce an environmentally friendly composites. The technology is already patented. It is by using simple and easy processes. The composites produced have good mechanical characteristics such as high mechanical strength about 7 GPa, heat resistance until by 240 °C and good resistance electrical conductivity. **[2]**

It is expected that the composites produced have mechanical strength at less equal to conventional materials used such as ceramic, PE but not easily broken and the composites are environmentally friendly as well. After the process of hot pressing, the composites produced muss be cutted at its edges (cutting at its sides). The cutting process stage was firstly run by using GUILLOTINE cutting machine and it gave very good results. Due to limited budget of institutions in running research project it is interesting to investigate how are the cutting results if the cutting process would be run by using inexpensive cutting machine such as the rotary blade cutting machine with chain rotary saw which is commonly used for woods or particle boards.

In this research, the analysis of the process of edges cutting of the environmental friendly composites (bio composites) by using for wood cutting machine with rotary saw with amount of blades (Z) of 60, 80 and 100 were done. The results could give idea how far the chain rotary cutting machine can be used to replace the GUILLOTINE cutting machine which is quiet expensive. The results as output for this research are the quality of cutting results and the electricity consumption.

## 2 Material and Method

### 2.1 Material

#### 2.1.1 Fibers of Oil Palm Empty Fruity Bunch

##### (1) Procurement of raw materials

The empty fruit bunch of oil palm (EFB) have been taken from palm oil mill at PTPN VIII, Kertajaya located in Lebak, Banten, Malimping, West Java. The EFBs are solid waste at that mill and generated after separation process between the bunches and the fruits at thresher. Before this process the bunches will be sterilized. The sterilization looses the physical binding force of the fruits to the bunches. The EFBs are transported by using truck with load abot 7-8 tons to Universitas Trisakti in Grogol, West Jakarta. The EFB will be fiberized manually. The burnt fibers, thorns, leaves, dust will be seperated. The only good fibers will be chosen as raw material.



**Figure 1** EFB, spikelets and chosen EFB Fibers

##### (2) Procurement potato powder as binding agent

The potatoes will be washed and dried. They will be then cutted into pieces and blended to be mashed potatoes. The mashed potatoes will be dried by sun. The dried mashed potatoes will be crushed manually to be powder. The powder will be filled in to hot water and stirred slowly. The powder in water became gel. This gel is called as the binding agent based on potato.

##### (3) Mixing of raw materials

The EFB fibers will be put into container and the gel of potato binding agent will be flushed to that fibers. The stuffs will be mixed manually so that the gel spreads prevalent to all the fiber surfaces.



**Figure 2** Mixing the EFB Fibers and Potato Binding Agent

##### (4) Forming/Prepregs production

The mixture of fibers and binding agent will be filled in a box as template to produce prepregs (see Figure 3). The mixture to be pressed to reduce its thickness such as to be 1 cm. This formed and pressed mixture between fibers and binding agent will be called as prepregs. Prepregs will be dried by using hot air behind the condasator of air conditioner. It took about 1 day to get a good result of prepregs. Prepregs are ready for further processes.





**Figure 3** Forming Process

(5) Hot Pressing/Biocomposite Production

Prepregs will be hot pressed by using a hydraulic press machine and the parameters as followed

- Duration: 30 minutes
- Temperature: 180 °C
- Max. Pressure: 40 tons



Hot Dice



Hydraulic Hot Press Machine

**Figure 4** Hot Pressing

The result of press process is a bio composite board where the EFB fibers and the binding agent based on potato become a homogenous body.



**Figure 5** Biocomposite

(6) Edge Cutting

As shown at Figure 5 the sides (edges) of the biocomposites need to be cutted to get a neat dimesion of biocomposite. Yhis cutting process is a subject for this research where the cutting results by using GUILLOTINE cutting machine would be compared with by using cutting machine rotary saw.





Guillotine Cutting Machine



Cutting Machine with Chain Rotary Saw

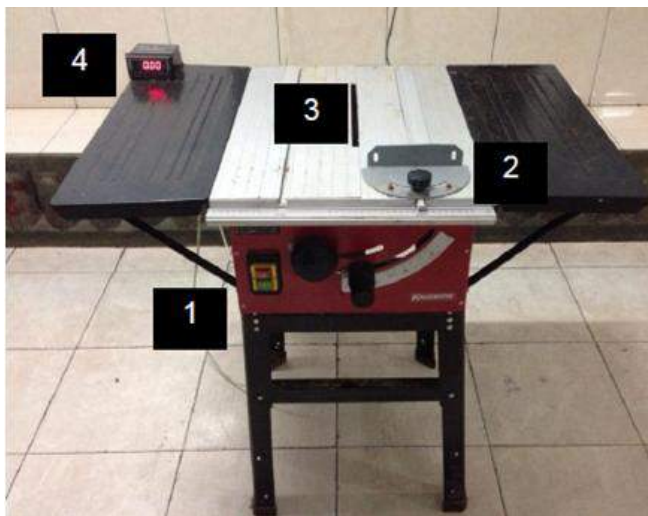
**Figure 6** Cutting Machines: Guillotine vs. Chain Roray Saw

## 2.2 Methods

The methods used is SNI 03-2105-2006 Papan Partikel [3] to produce the samples.

## 3 Conclusion

The cutting machine with chain rotary saw is installed with equipments so that its electricity consumption can be recorded [5].



### Description:

- 1 Working table
- 2 Driving specimens
- 3 Rotary saw
- 4 Ampere meter

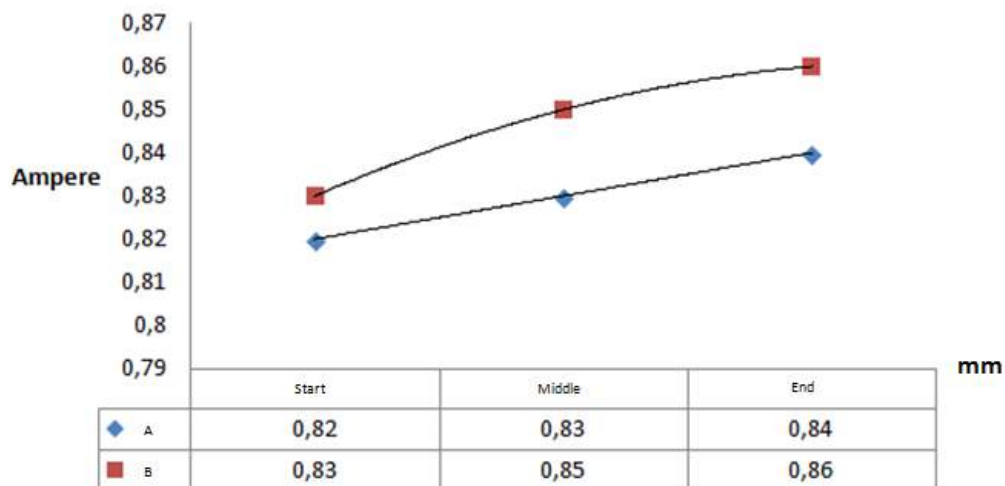
**Figure 7** Installed Equipments at Cutting Machine with Chain Rotary Saw [5]

The cutting results between using Guillotine and rotary saws with  $Z=60, 80$  and  $100$  are shown at Table 1 below where the results with rotary saw still can not get the quality as using Guillotine cutting machine.

**Table 1** Cutting results by Using Guillotine Cutting Machine, Rotary Cutting Machine with Z=60, 80, 100 [5]

GUILLOTINE cutting machine	Rotary Saw Z=60	Rotary Saw Z=80	Rotary Saw Z=100
			
			

The electricity consumption of each chain rotary saw are recorded and will be compared between Z=60, 80, 100. The example of recorded electricity consumption is shown in Figure 8. Through the gain datas it is possible to get the correlation of its consumption. Tabelle 2 shows an example which equation matches to reflect the running cutting process by using chain rotary saw Z=60.



**Figure 8** Electricity Consumption of Chain Rotary Saw Z=60 [5]

According to dermination coefficient ( $R^2$ ) it shows that the equation in polynomial approach matches as the closest equation that can reflect the running cutting process by using rotary saw.

**Table 2** Correlation as Equation for Electricity Consumption by Z=60 [5]

Equiation	Formula		$R^2$	
	Side A of Composite	Side B of Composite	A	B
Exponential	$y = 0.8102e^{0.012x}$	$y = 0.817e^{0.0178x}$	1	0.9626
Linear	$y = 0.01x + 0.81$	$y = 0.015x + 0.8167$	1	0.9643
Logarithmic	$y = 0.0178\ln(x) + 0.8194$	$y = 0.0275\ln(x) + 0.8303$	0.97	0.99
<b>Polynomial</b>	<b><math>y = 0.01x + 0.81</math></b>	<b><math>y = -0.005x^2 + 0.035x + 0.8</math></b>	<b>1</b>	<b>1</b>
Power	$y = 0.8194x^{0.0215}$	$y = 0.8303x^{0.0325}$	0.9787	0.99

After comparing all the datas given from the experimental studies it get the conclusion that the cutting results by using rotary machine at the chain rotary saw by cutting discs  $Z = 100$  is better than  $Z = 60$  and  $Z = 80$  where the surface results are smooth and gave less damage or less rejected results. The cost of electricity consumption of cutting composites using disc saws  $Z = 80$  is most expensive because it needed longer cutting duration in comparison to  $Z = 100$  and  $60$ . Although it must be considered that the experiments are run manually so that human error could be ocured for those the results. The installment of further component in the near future such as pneumatic pushing component with constant speed can reduce surely the error.

#### **4 References**

- [1] Badan Pusat Statistik (2013). "Direktori perkebunan kelapa sawit 2012" No publikasi: 05130.1104, ISBN.978-979-064-293-5
- [2] Arya, A. C. (2005). Technologische Untersuchungen zur Herstellung von Bauteilen aus Fruchtbündelfasern der Ölpalme, Dissertation, TU Dresden, Germany
- [3] SNI 03-2105-2006. (2006). Papan Partikel. Badan Standarisasi Nasional, Indonesia
- [4] DIN 53 495 (1984). Prüfung von Kunststoffen – Bestimmung der Wasseraufnahme, Germany
- [5] Arya, A. C.; Wensen (2015). Analisa Proses Pematangan Bidang Sisi Bio Komposit Dari Serat Tandan Kosong Sawit. Bachelor Thesis. Mechanical Engineering Department, Fakultas Teknologi Industri, Universitas Trisakti. Jakarta, Indonesia (*as part of RAPID research project*)

# Formulating Standard Form of Construction Contract in Indonesian Context

<sup>1</sup>Seng Hansen

<sup>1</sup>Podomoro University, APL Tower 5<sup>th</sup> Floor Jakarta – Indonesia  
[seng.hansen@podomorouniversity.ac.id](mailto:seng.hansen@podomorouniversity.ac.id), 087883496227

## Abstract.

Construction contract can be defined as a legally binding agreement between one party to another in doing construction business. It serves as the foundation in executing a construction project. If made and managed properly, it will minimize the appearance of potential disputes in construction projects. Indonesia as the fourth largest construction market in Asia needs a standard form of construction contract in order to give the same understanding towards some principles, definitions and interpretations of contract clauses. However there is no single common standard form of construction contract produced by an entity which will greatly boost the dynamic of this industry. Therefore, this applied research has objectives: (1) to identify the advantages and disadvantages of standard forms of construction contract, (2) to identify the challenges in adopting standard forms of construction contract in Indonesia, and (3) to propose a model of standard form of construction contract which in line with Indonesia construction industry requirements. The research method used for this report was a comprehensive review of the literature over the past 10 years and contract document analysis. From this analysis we can derive the answers for each question and generates a standard form of construction contract which has been modified to meet the Indonesian context.

**Keywords:** *construction contract, standard form, benefits of standard form, Indonesian context.*

## 1 Introduction

In short, construction industry can be defined as an economic sector which engaged in preparation of land; construction, alteration, repair and demolition of buildings; and other related areas of built environment. It possesses some major characteristics which differentiate the industry with other sectors of industry: (1) it has a one-off nature, (2) construction projects are big scale projects which can be seen from their size, scope, cost and people involved in this industry, (3) construction projects by nature are complex, (4) location has an important role in determining the construction projects' successfulness, (5) although there are some innovation in accelerating the duration and increasing the quality of projects, most of the parts are still constructed *in situ* or on the site, (6) while it is regarded as one of the most labour intensive industries, its workforce is very dynamic and transient (always move from one location to another), and (7) by nature it is a male dominated industry.

Construction industry for many years has become one of the major sectors which contributed almost 10% annually to Indonesia's GDP. It is the largest construction market in Southeast Asia and the fourth largest in Asia next to China, Japan and India. According to the latest survey conducted by AECOM [1], Indonesia is the top rated country followed by China in terms of construction market growth in Asia. Jakarta is also rated number 1 as the city or metropolitan region with the fastest growing construction market in Asia, and rated number 2 after Singapore as the city with the most profitable construction market in Asia.

Meanwhile, according to the Indonesia's Statistic Central Agency data on 2010-2013, there are about 131,000 construction related companies which spread all over the archipelago. This sector needs approximately 6 million people, which approximately only 10% of them are experts with related educational background. Therefore, construction industry is always seen as one of the most labour intensive industries in Indonesia.

With so many people involved in this industry, the need of good governance and coordination is a must in achieving the common goals of this industry i.e. to complete the construction projects within budget, the specified duration, and the required quality. However what happened in practice is that

there are so many problems occurred due to: (1) the lack of coordination between all of the people involved in construction projects, (2) the lack of legal framework system, and (3) the lack of clarity in the making of construction contracts and on executing the contracts. These problems have always potentially become construction disputes which will eventually lead to losses for many parties involved in this industry.

Construction contracts serve as the main guidance for parties involved in construction business. It has 4 (four) major functions i.e: (1) to make a legally binding relationship between parties involved, (2) to distribute all risks in construction business, (3) to declare all rights, obligations, and responsibilities of the parties, and (4) to state all contract conditions and procedures. Seeing the importance of construction contracts in this business, the contract drafting becomes very important especially with regard to the negotiation process and in distributing the rights and risks of parties involved so that the contract can perform its functions as mentioned above.

Nowadays, there have been many standard forms of construction contract which introduced by construction professional industries from many countries. These include FIDIC (*Fédération Internationale Des Ingénieurs-Conseils*), JCT (Joint Contract Tribunal), and ICE (Institution of Civil Engineers). In spite of all its benefits, Indonesia still does not have a common standard form of construction contract which could be applied across the country. What happened in practice is that there are various contract forms which produced by many institutions and companies, and be used only for them. Each of these contract forms differs greatly from each others. Although at some degree these contract forms can facilitate the process of negotiating and contract drafting, there is no certainty that the correct principles of contract have been applied. In addition, the benefits of the widespread introduction of a common standard form would not be reached.

Focusing on these problems, the researcher is conducting a research that has the following objectives: (1) to identify the advantages and disadvantages of standard forms of construction contract, (2) to identify the challenges in adopting standard forms of construction contract in Indonesia, and (3) to propose a model of standard form of construction contract which in line with Indonesia construction industry requirements.

## **2 Literature Review**

The essence of a contract is the agreement. Therefore, in Indonesian Civil Code, contract is considered as an agreement. According to Indonesian Civil Code Article 1313, an agreement is an act pursuant to which one or more individuals bind themselves to one another. Meanwhile, according to the Presidential Regulation No. 54/2010, contract is defined as a written agreement between PPK (official commitment maker) and contractor/supplier or independent practitioner. This Presidential Regulation's definition is adjusted to set the context for governmental procurements.

When viewed from its orientation, construction contracts are essentially closer to engineering contracts compared with the general contracts. This is mainly because the construction contract is a manifestation of the construction project's characteristics that are loaded with so many technical aspects of the cost, time and quality. These three aspects of cost, time and quality is the main focus of construction project and contract management. Meanwhile the general contract is focusing on the legal aspects so a contract can be legally binding. Therefore, engineering contract is not essentially talking about legal aspects of a contract, but also its technical aspects which become the main artery of construction business. Knowledge of the legal aspects of the contract remains as a crucial matter to ensure that the contract has the force of law.

A standard form contract is commonly defined as a contract between two parties involved where the terms and conditions of the contract have been set and therefore it leads to a "take it or leave it" negotiation. This definition is not completely true especially with regard to the principle of freedom of contract. Therefore, this research paper is trying to define a standard form of construction contract as an attempt to equalize perceptions, terms and conditions which is manifested in the form of construction contract, and is made based on the correct principles of contract, and serves as the guidance in negotiating and drafting a construction contract. While the first and common definition focuses on the result and effect of a standard form of contract, the latter definition focuses on the essence and process of a standard form of contract.

The usage of standard form of construction contract has many advantages. There have been many researchers who are trying to highlight these advantages. Rameezdeen and Rodrigo [5] had summarized these advantages into 9 (nine) points:

1. It can be used for various types of projects and client requirements
2. It embodies industry practices and customs
3. Parties can be comfortable with the fact that it has been tried and tested over a long period of time
4. Fair allocation of risks between parties
5. In a competitive tendering environment, it provides a uniform basis for pricing without the fear of hidden costs
6. The tendered price is likely to be lower as contractors do not have to price additional risks associated with interpretation of bespoke contracts or clauses
7. Transaction cost involved in negotiating a contract is reduced
8. It looks at three dimensions together, namely: the wider legal context through statutes and case law, other documents forming the contract, and areas of possible disagreements between parties
9. The familiarity with clauses improves communication and efficiency of contract administration between client, contractor and the contract administrator

Meanwhile, Shnookal and Charrett [7] gave 4 (four) main advantages of using a standard form of construction contract, ie:

1. Contractors, employers and engineers who use a standard form contract become familiar with the rights and obligations that they have under that form of contracting. This improves communication and efficiency in contract administration. This is of particular importance in international contracting where communication is more difficult and misunderstandings are proportionately more likely to arise
2. The cost of tendering is reduced as contractors familiar with the standard form know there is no risk that is hidden in the detail of terms they are unfamiliar with
3. The cost of negotiating the contract is reduced. Increasingly negotiating the legal terms of a bespoke contract based on a major law firm's contract has become a major cost of project delivery. Using a trusted standard form reduces the potential area of disagreements, or at the very least, provides an impartial starting point from which the parties can negotiate from
4. The tendered price is likely to be less than for a bespoke contract, as contractors do not have to price additional risks they are not familiar with or are not usually required to assume

Another important highlight on the advantages of using standard forms of construction contract instead of composing a fresh contract document for each project has been set out by Ramus et al. [6] ie:

1. Ambiguities and inconsistencies are minimized since they are written by legal experts
2. They set out clearly the rights and obligations of parties involved to the required degree of detail
3. Because of standardization, frequent users are familiar with the provisions, resulting in a greater degree of consistency in the application
4. The time and expense which would be incurred in preparing a fresh document for each occasion is avoided
5. They can provide a good source of knowledge for construction professionals

Based on its sources, Lestari [3] has classified construction contracts in Indonesia into 2 (two) types: domestic contracts which normally used for construction projects owned by domestic institutions and international contracts such as AIA (American Institut of Acrhitect), FIDIC, JCT, and SIA. In practice, normally for international and private projects executed in Indonesia, FIDIC will be the most common standard form to be used. Zarabizan et al. [10] said that one of the advantages of FIDIC conditions is that it has become a standard international form where an agreement has been approved and made public by a prestigious body such as architects, engineers, and contractors.

All of these contract forms used and executed in Indonesia – both domestic and international contracts – must follow the Indonesian Contract Law. The law which governs the agreement/contract is contained in the Indonesian Civil Code Book III on Obligations. This Civil Code actually is a legacy of the Dutch East Indies, namely the *Burgerlijk Wetboek*.

In addition, the Indonesian Contract Law is further stipulated in other legislations which have been issued by the government of the Republic of Indonesia relevant in the field of construction services, among others are:

- Indonesian Law No. 18/1999 on construction services
- Government Regulation No. 28/2000 on the business and the role of construction service community
- Government Regulation No. 29/2000 on the implementation of construction services
- Government Regulation No. 30/2000 on the implementation of construction services development
- Presidential Decree No. 80/2003 on the guidance for governmental procurement

According to Suraji et al. [9] the following strategic agenda is recommended in order to improve the competitiveness of Indonesia construction industry, namely:

1. Revitalization of construction sector
2. Strengthening and growth of construction sector
3. Establishment of regulatory framework for construction
4. Establishment of fair construction trade
5. Empowerment of institutions for construction development
6. Improvement of synergy among construction related sectors
7. Development of construction technology
8. Improvement of competency of human resources
9. Monitoring of construction business
10. Protection of user and beneficiaries of construction product
11. Improvement of construction investment
12. Capacity building of local government for local construction
13. Development of traditional construction and non-engineered buildings

In response to Suraji's recommendations, the need for standard forms of construction contract is becoming more important in Indonesia in order to increase and improve the business process and competitiveness of this industry. However as pointed out by Patterson [4], many standardized contracts are created under circumstances that put control of the process in the hands of parties on one side of the contract.

Another challenge is that there are so many types of construction procurement which need different approaches and different standard forms of construction contract to be applied with. Institutions which produce international standard forms of construction contract have already pointed out this problem and published not only one standard form but many standard forms of construction contract which have been adjusted with the current construction procurement methods.

Gould [2] stated that the most easily identifiable benchmark is the simple distinction between traditional procurement and the design-and-build procurement. Essentially, standard forms could be divided into those where the contractor simply constructs the design and those where the contractor is responsible for the design.

Since there is still no common standard forms of construction contract published in Indonesia, the construction professionals often use their own bespoke contracts or the international standard forms of contract such as FIDIC. In practice, they tend to amend these standard forms of contract which sometimes result in construction disputes between parties involved. This is another challenge which Gould [2] has already concerned about. He said that the guidance notes to most of the standard forms state that the forms have been drafted to carefully balance the rights and obligations of the employer and contractor or other parties as the case maybe. On this basis users are warned not to upset this balance by amending the standard form.

The practices in this industry have also been criticized with lack of fairness and professionalism, and even with the conflicting regulations. Moreover, according to Soemardi and Wirahadikusumah [8], globalization also requires the Indonesian construction industry to be able to respond with the development of international contract and regulations.

### **3 Research Methodology**

The research method used for this report is mainly based on literature reviews and documents analysis. Literature review is a literature sourced from books, journals and other media that aims to develop the basic theory that will be used in conducting the research. In order to make a comprehensive and effective review, the selection of literature was based mainly of those researches in the last past 10 years (2005-2015) and from the analysis of Indonesian Civil Code and related regulations.

Document analysis is a qualitative research technique in which the documents related to the topic research were collected for later being analyzed and interpreted by the researcher. Documents referred to herein are all written documents which define the roles, responsibilities and procedure of the construction work under construction contracts. The documents collected by researcher in this paper are the contract documents collected for almost 2 (two) years at the time the researcher still was a contract administrator at one of Indonesia's leading construction companies. There are various kinds of construction contract documents but basically they can be classified into 3 (three) types: traditional contracts, design-build contracts, and EPC contracts. From this document analysis then the researcher can create a model of standard form of construction contract which has been adjusted and comply with the Indonesia construction industry practices.

### **4 Research Findings**

After analysing both through literature review and contract documents analysis, the researcher tries to answer each question which becomes the objectives of this research paper.

#### **4.1 The Advantages and Disadvantages of Standard Forms of Construction Contract**

In fact, often the construction disputes arising in this industry are actually a thing that can be minimized or avoided with the same understanding and interpretation of contract terms and provisions. However, due to improper construction contract drafting makes it not feasible and lead to potential conflicts. Some examples of this are the issues related to the definition of lump sum or fixed price contract in Indonesia, the responsibility of the nominated subcontractors, unforeseen physical conditions, and a few other things. Opinion and understanding differences of related matters above may lead to the losses of parties involved in construction projects. Therefore, a good project management requires a common understanding between the parties on the contract terms and definitions.

One of the main objectives of standard forms contract is to provide this common understanding regarding this matter. Although not an obligation, utilizing an already published standard form is a common practice. These standard forms of contract have been created and compiled by many professionals in this industry. Some of these well known international standard forms of construction contract are:

- a. FIDIC (*Fédération Internationale Des Ingénieurs-Conseils*)
- b. RIBA (Royal Institute of British Architects)
- c. ICE (Institution of Civil Engineers)
- d. AIA (the American Institute of Architects)
- e. ACA (Association of Consultant Architects)
- f. NEC (New Engineering Contract)
- g. JCT (Joint Contracts Tribunal)
- h. SIA (Singapore Institute of Architects)
- i. BPF System (British Property Federation)

Nevertheless, the existence of a standard form of contract itself has advantages and disadvantages. To identify these advantages and disadvantages is one of the objectives of this research. What is meant by advantages here is the perceived benefits if a common standard form of contract introduced and used broadly. The same applies for the term of disadvantages. By knowing this, it is expected that the Indonesian construction professionals will have the same understanding on the importance of the issuance of standard form contracts in Indonesia.



**Table 1** Advantages and Disadvantages of Standard Forms of Construction Contract

<b>No</b>	<b>Advantages</b>	<b>Disadvantages</b>
1	It is a standard form which is used broadly so that the contract provisions can already be understood by the parties involved. In other words, it minimizes the possibility of misunderstandings related to the contract provisions, interpretations, and contract descriptions	Because it is a standard form of construction contract, it is not necessarily suitable for all construction projects
2	It is usually has been adapted to international contract standards so that it may facilitate the understanding of the implementation of international contracts.	There are many international standard forms of construction contract such as FIDIC, JCT, AIA etc which are created and developed by groups of different industries so that it may not be suitable for certain types of projects or regulations
3	It already covers almost all the possible issues that may arise in executing construction projects	Because it covers almost all the possible issues, it is normally thick and complex
4	Since it is a common standard form, all parties can learn the possible results of a similar dispute that has happened before	The dependence on standard form of construction contract may bring potential conflict between parties because they tend to not make a necessary assessment and negotiation related to the project needs and interests during the contract drafting period
5	It can be obtained at a relatively affordable price	It needs to be up-dated in accordance with the legal, technology and industry developments
6	It is designed by all key stakeholders in this industry who understand the minimum requirements in drafting and negotiating the construction contracts (it serves as a guidance)	Although it may be used as a guidance or reference, the contract provisions may need to be modified to fit the needs of the project and the interests of the parties involved
7	The risk distribution between the employers, consultants, and contractors can be more easily understood (not blurry or biased)	At a certain level, the use of standard form of construction contract will reduce the creativity of the parties when negotiating the contracts
8	It makes construction industry becoming more competitive	At a certain level, the use of standard form of construction contract will reduce the level of competitiveness of the bidders
9	It can provide a good understanding regarding construction contract and its principles to many people	
10	There is no need to draft a contract from the scratch (saving time)	
11	No more disputes arising from the differences in interpretation of the contract language or contract terms (ambiguities and inconsistencies are minimized)	
12	It can provide a good source of knowledge for students in construction related disciplines as well as for construction professionals	
13	It will improve the effectiveness of project control, communication and contract administration, including construction claims	
14	It will increase the efficiency and reduce the costs of negotiation, including legal costs	
15	It will reduce the tender price since contractors do not have to price additional risks	

16	It reflects the local and international industry practices and customs	
17	It will help in creating a new legal framework on how to decide and settle construction disputes	

#### 4.2 The Challenges in Adopting Standard Forms of Construction Contract in Indonesia

After identifying the advantages and disadvantages of the standard forms of construction contract, the next step is to identify the various challenges in adopting standard forms of construction contract in Indonesia. These challenges mainly come from the common construction industry practices in Indonesia. Beside to identify these challenges, this research paper also seeks to provide solutions for these challenges. Thus, these solutions are expected to make the preparation and publication of standard forms of construction contract which in accordance with the Indonesian context can be immediately realized.

**Table 2** The Challenges and Solutions in Adopting Standard Forms of Construction Contract in Indonesia

No	Cause	Effect	Solution
1	Accountability in the court of law	There is still no regulating/authorized body or agency who is responsible and accountable to make standard forms of construction contract	Government may establish or appoint a professional agency to become a body which is responsible for the making, publishing and socializing the standard forms of construction contract
2	Conflicting regulations	Conflicting regulations hinders the process of drafting common standard forms of construction contract	Government and other key players in this industry must work together to improve the regulations
3	Lack of fairness and professionalism	Lack of fairness and professionalism makes this industry less competitive and prone to corruption	Making and publishing a standard form of construction contract is one of the most significant step in combating this challenge
4	Players in this industry think that there is no or minimum benefits in implementing and enforcing standard form	Misunderstanding on the benefits and usage of standard forms of construction contract	The benefits must be socialized widely, by / through government, universities, and professional bodies
5	Lack of awareness	Lack of awareness in the importance of producing standard forms of construction contract on the overall contract management	The professional body must produce reliable standard forms of construction contract which adapted to the local context
6	Reluctant to change the current practice	Players in this industry do not want to change the current practice	Government may enact the usage of standard forms of construction contract
7	Lack of socialization	Players do not aware of the importance and benefits of standard forms of construction contract	Government, universities and professional bodies should initiate the socialization either through seminars or workshops and through the enactment of laws
8	In practice, players often try to modify the standard forms	The changes of the contract provisions in a standard form often cause the main goal of construction business is not	Changes and modification to contract provisions should be done only by those with proper educational background on

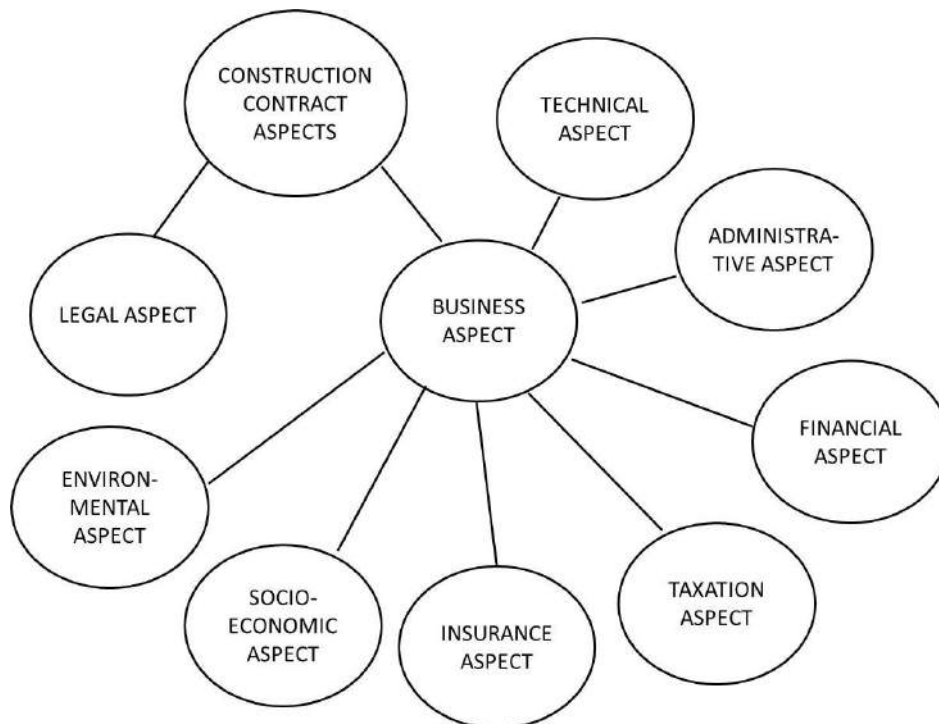
		achieved	contract management
9	With not many issues and disputes that have arisen and resolved through the courts	Players in this industry think that there is no need to enforce the usage of standard forms of construction contract immediately	Government, universities, and professional bodies must provide an understanding on the importance of standard form as a tool to prevent the occurrence of construction disputes
10	Players in this industry think that construction contracts should be made by the legal people	Construction contracts cannot function properly due to lack of technical aspect consideration in the making of construction contracts	Promote the benefits of standard forms of construction contract in bridging both the technical and legal aspects of construction contract. It will be much better if construction contracts made by construction professionals with legal knowledge
11	The usage of contract language	People may find it hard to understand and utilize standard forms of construction contract since it uses contract language which contained with so many legal and technical language	Standard forms of construction contract must be designed to be able understood by many people and easy to use. The usage of clear and unambiguous language is the most important thing in order to avoid unnecessary misunderstandings and disputes

#### **4.3 Proposed Model of Standard Form of Construction Contract in line with Indonesian Context**

The third objective of this research paper is to formulate a model of standard form of construction contract which is in line with the Indonesia construction industry requirements. Construction industry in Indonesia already has so many strength points in terms of its richness of both natural and manpower resources available in Indonesia. The large manpower resources for construction workers and professionals means a cheap labor cost for construction industry. There are also many institutions established in order to upgrade this manpower resources competence. The growth of national economy also plays a major part in construction sector. Indonesia is well known for its vast land area compared with other ASEAN nations and it is need to be developed. However, there are two main weaknesses of Indonesia construction industry, namely the corruption problems and the political stability. Fortunately the government has already taken many necessary steps in combating the corruption problems in Indonesia. Meanwhile the political stability in Indonesia has also improved for the last decade.

Considering the improved situation and condition for construction industry in Indonesia, it is the right time for Indonesia to move forward by developing and enforcing a common standard form of construction contract in order to enhance the efficiency and competitiveness of this industry. This standard form of construction contract should be made by adjusting to the local practice and wisdom so that it can be socialized and implemented more easily and thoroughly. The basic principle is that this model of standard form contract must be made so that it is can be used and understood easily by all people involved in this industry. This model is structured as a basic guideline in planning and designing of various standard forms of construction contract.

In proposing a model of standard form of construction contract, 2 (two) main aspects must be analysed. The first aspect is related to the compliance of standard form of contract with the Indonesian laws and regulations. The second aspect is related to the compliance of standard form of contract with the Indonesia construction industry practices.



**Figure 1** Aspects in Construction Contracts.

#### 4.3.1 The Compliance with the Indonesian Laws and Regulations

According to Indonesian Law, there applies a principle which gives the freedom of the parties to determine the terms and conditions of agreement which will be valid and binding for the parties made it. It is called as the principle of freedom of contract. This principle has been set out in Article 1338 of the Indonesian Civil Code, which reads:

*"All valid agreements apply to the individuals who have concluded them as law. Such agreements are irrevocable other than by mutual consent, or pursuant to reasons stipulated by the law. They must be executed in good faith."*

This principle of freedom of contract means that parties have the freedom to make arrangements in accordance with their respective interests. This freedom includes:

- a. The freedom of the parties to decide whether to make an agreement or not
- b. The freedom to choose to whom they will make an agreement
- c. The freedom in determining the form of the agreement
- d. The freedom in determining the contents of the agreement
- e. The freedom in determining ways of making the agreement

Nevertheless, this principle of freedom of contract still has limitation of not be contrary to Indonesian laws, public order and decency. This restriction has been set forth in Article 1337 of the Indonesian Civil Code, which reads:

*"A cause is prohibited if it is prohibited by law or if it violates morality or public order."*

Furthermore, the Indonesian Civil Code has also described the types of obligation or agreement under the Article 1233 and 1234, which reads:

*"All obligations arise either from agreements or law."* (Article 1233)

*"Their purpose is to provide something, to do something or not to do something."* (Article 1234)

Meanwhile, according to Article 1320 of the Indonesian Civil Code, there are at least 4 (four) conditions that should be met for an agreement to be valid, ie:

1. There must be consent of the individuals who are bound thereby
2. There must be capacity to enter into an obligation
3. There must be a specific subject matter
4. There must be a permitted cause

A valid contract must also have a particular cause as a subject of matter. This cause may be an item whose nature is determined. The quantity of the matter needs not be ascertained, insofar such quantity can be determined or calculated at a later date. This provision can be found in Article 1333 of the Indonesian Civil Code.

The effects of agreements have been described in Article 1339 to 1340, which reads:

*“Agreements is bind the parties not only to that which is expressly stipulated, but also to that which, pursuant to the nature of the agreements, shall be imposed by propriety, customs, or the law.”* (Article 1339)

*“An agreement applies only to the parties thereto. An agreement cannot be detrimental to third parties; third parties cannot benefit from them, except for the case stipulated under Article 1317.”* (Article 1340)

In response to void contract, Article 1321 of the Indonesian Civil Code states that no consent is valid if it is granted based on mistake or obtained by duress or fraud. Article 1322 to 1337 gives details on the validity of a contract in Indonesia.

**Table 3** Contract Validity in Indonesian Context

Validity Requirements	Contained in
Binding agreement	Contract preamble, contract premises/recitals, signature of the parties involved
Capacity to make an agreement	Company's name of the parties involved, names of the representative, their position and authority
Having a subject of matter	Scope of work, contract price, starting date and duration of the work, date of completion
Having a permitted cause	Clauses about the governing laws

In addition to the aspects related to the validity of a contract, legal aspects of construction contract also deals with aspects of contract termination, suspension of work, dispute settlement, the ruling language as well as contract addendums and amendments.

For Indonesian government projects, the specification is made and defined by the official commitment maker (PPK) as stipulated in Presidential Decree No. 54/2010 and amended in Presidential Decree No. 70/2012.

In response to the *force majeure* and its implications, the Indonesian Civil Code Article 1244 states: *“If there is any reason for such, the debtor is compensated for costs, damages and interests if he cannot prove, that the non-performance or the late performance of such obligation, is caused by an unforeseen event, for which he is not responsible and he was not acting in bad faith.”*

Furthermore, Article 1245 states:

*“The debtor needs not compensate for costs, damages or interests, if an act of God or an accident prevented him from giving or doing an obligation, or because of such reasons he committed a prohibited act.”*

Court mediation procedure is stipulated in the Supreme Court Regulation (PERMA) No. 2/2003. Mediation is an alternative dispute resolution which is considered as simple and cost effective. Another dispute resolution is through arbitration. The Indonesian Law No. 30/1999 on arbitration has defined it as a way of settling a civil dispute outside the court based on the arbitration agreement which has been made in writing by the parties in dispute. Unlike dispute settlement through the court, arbitration held in private and confidential. The arbitration procedure is generally more flexible when compared with the court procedure.

#### 4.3.2 The Compliance with the Indonesian Construction Industry Practices

On other hands, the business aspects of a construction contract have many dimensions, namely: technical aspect, administrative aspect, financial aspect, taxation aspect, insurance aspect, socio-economic aspect, and environmental aspect. The technical aspect is the most dominant aspect

considering construction contracts always related to construction engineering processes which are then written into the contract language.

In general, the technical aspect related to the construction quality and time management. This includes contract documents (including technical specifications and construction drawings), time of completion and construction schedule (including extension of time), construction methods, site conditions, methods of measurement, and the acceptance of work (including the quality assessment of the completed project).

Construction projects also talk about the administrative works. This includes all activities related to correspondence, project activity reports, work progress reports (daily, monthly, etc), routine project management, and the taking over procedures. In addition, performance appraisal and foremen, subcontractors and suppliers are also included in this aspect. Contract administration aspect is also associated with handling procedures of *force majeure* that may occur and violation committed by the contractor.

The contract value, claim calculations, payment procedures and guarantees related to the financial management of the project are including in the financial aspect. Bank Guarantee or BG is the most commonly used type of guarantee. In addition, Letter of Credit or LC and Surety Bond are also quite often used.

Business related aspect of taxation is talking about the Value Added Tax (VAT) and Income Tax. According to Indonesia Law No. 18/2000 and the Director General of Taxation Decree No. KEP-10/PJ/1995, all construction projects are subject to VAT. VAT is a type of indirect tax levied at each level in the production, distribution, marketing and management lines. It is a consumption tax that is placed on a product whenever value is added. VAT in Indonesia is 10% (ten percent). Disputes may arise when the contractors do not submit VAT received from the employers to the government. This may turn into difficulties for the employers when they want to apply for withholding tax refunds. In addition to VAT, the construction services activities are also subject to income tax in accordance with the Indonesia Law No. 17/2000. Income tax is a type of direct tax levied by almost all governments in the world.

Insurance aspect is related to the type of construction project insurance which has been stipulated in the contract. As has been known, construction projects are normally large scale projects and are at high risk so that almost all construction projects utilizing insurance services in its implementation. The most commonly used insurance is Contractor's All Risk (CAR) and Third Party Liability (TPL). Moreover, given the construction industry is also regarded as an labor intensive industry where many workers are working with a high level of accidental risk, the other mandatory insurance by Indonesia Law are the workers insurance and health insurance. The problems which may occur is if there is a project's extension of time, then the insurance must be renewed in accordance with the duration of extension of time.

As with government projects, it is normal to find clauses which require the contractors to utilize materials and equipments acquired from around the site or from within the country as well as using local workers. These are included in the socio-economic aspect of a construction contract.

In addition to the above aspects, there is also an environmental aspect which must be stipulated in the contract according to Indonesia Law No. 18/1999 Article 22 paragraph 2(m). To bring together all the parties' interests and the relevant aspects in the implementation of a construction project requires precision and caution so that the process of drafting and negotiating construction contracts are never be an easy thing to do. In the event of inconsistencies during the preparation of construction contract where these aspects are not addressed, then the potential of arising construction disputes can be even greater.

### **4.3.3 Results**

After conducting the analysis as mentioned above, then a proposed model of standard form of construction contract can be made. This proposed model is not made in form of a contract document, but rather be made in form of a set similar with body of knowledge. This proposed model consists of 2

(two) parts. The first part is about the anatomical structure of the construction contract which has been adopted from international standards and adapted to the Indonesian construction industry context, while the second part is about the embodiment of the various aspects in construction contract.

The anatomy of construction contract below is adopted from FIDIC and has been adapted to Indonesian context. FIDIC is selected because it is the most widely used international standard form of contract in Indonesia. Thus, it is expected that Indonesia can publish its own version of standard form of construction contract with international standard and it can be easily socialised and accepted by the industry.

**Table 4** The Proposed Anatomy of Construction Contract

No	Anatomy	Sub-Anatomy
1	General Provisions	Definitions Interpretation Communications Governing Law and Language Priority of Documents Contract Agreement Assignment Care and Supply of Documents Delayed Drawings or Instructions Employer's Use of Contractor's Documents Contractor's Use of Employer's Documents Confidentiality Compliance with Laws Joint and Several Liability Rights and Obligations of Parties
2	The Employer	Right of Access to the Site Permits, Licenses or Approvals Employer's Personnel Employer's Financial Arrangements Employer's Claims
3	The Engineer/CA/ Superintendent	Engineer's Duties and Authority Delegation by the Engineer Instructions of the Engineer Replacement of the Engineer Determinations
4	The Contractor	Contractor's General Obligations Performance Security Contractor's Representative Subcontractors Assignment of Benefit of Subcontract Co-operation Setting Out Safety Procedures Quality Assurance Site Data Sufficiency of the Accepted Contract Amount Unforeseeable Physical Conditions Rights of Way and Facilities Avoidance of Interference Access Route Transport of Goods Contractor's Equipment Protection of the Environment Electricity, Water and Gas Employer's Equipment and Free-Issue Material Progress Reports Security of the Site

		Contractor's Operations on Site Fossils
5	Nominated Subcontractors and Nominated Suppliers	Definition of NSC and NS Objection to Nomination Payments to NSC and NS Evidence of Payments
6	Staff and Labour	Engagement of Staff and Labour Rates of Wages and Conditions of Labour Persons in the Service of Employer Labour Laws Working Hours Facilities for Staff and Labour Health and Safety Contractor's Personnel Records of Contractor's Personnel and Equipment Disorderly Conduct
7	Plant, Materials and Workmanship	Manner of Execution Samples Inspection Testing Rejection Remedial Work Ownership of Plant and Materials Royalties
8	Commencement, Delays and Suspension	Commencement of Works Time for Completion Programmes Extension of Time for Completion Delay caused by Authorities Rate of Progress Delay Damages Suspension of Work Consequences of Suspension Payment for Plant and Materials in Event of Suspension Prolonged Suspension Resumption of Work
9	Tests on Completion	Contractor's Obligations Delayed Tests Retesting Failure to Pass Tests on Completion
10	Employer's Taking Over	Acceptance of the Work Taking Over of the Works and Sections Taking Over of Parts of the Works Interference with Tests on Completion Surfaces Requiring Reinstatement
11	Defects Liability	Completion of Outstanding Work and Remedying Defects Cost of Remedying Defects Defects Liability Period Extension of Defects Notification Period Failure to Remedy Defects Removal of Defective Work Further Tests Right of Access Contractor to Search Performance Certificate Unfulfilled Obligations Clearance of Site
12	Measurement and Evaluation	Works to be Measured Method of Measurement Evaluation



		Omissions
13	Variations and Adjustments	Right to Vary Value Engineering Variation Procedure Payment in Applicable Currencies Provisional Sums Daywork Adjustments for Changes in Legislation Adjustments for Changes in Cost
14	Contract Price and Payment	The Contract Price Procedure of Payments Advance Payment Application for Interim Payment Certificates Schedule of Payments Plant and Materials intended for the Works Issue of Interim Payment Certificates Payment Performance Bond Advance Payment Bond Retention Delayed Payment Payment of Retention Money Statement at Completion Application for Final Payment Certificate Discharge Issue of Final Payment Certificate Cessation of Employer's Liability Currencies of Payment
15	Termination by Employer	Notice to Correct Termination by Employer Valuation at Date of Termination Payment after Termination Employer's Entitlement to Termination
16	Suspension and Termination by Contractor	Contractor's Entitlement to Suspend Work Termination by Contractor Cessation of Work and Removal of Contractor's Equipment Payment on Termination
17	Risk and Responsibility	Indemnities Contractor's Care of the Works Employer's Risks Consequences of Employer's Risks Intellectual and Industrial Property Rights Limitation of Liability
18	Insurance	General Requirements for Insurance Insurance for Works and Contractor's Equipment Insurance against Injury to Persons and Damage to Property Insurance for Contractor's Personnel
19	Force Majeure	Definition of Force Majeure Notice of Force Majeure Duty to Minimise Delay Consequences of Force Majeure Force Majeure Affecting Subcontractor Optional Termination, Payment and Release Release from Performance under the Law
20	Claims and Disputes Settlement	Contractor's Claims Amicable Settlement Arbitration
21	Addendum and Amendment	Addendum and Amendment

Because the construction contract serves as the main guideline in implementing construction projects, all aspects of the construction business should be incorporated into the contract in simple form and language. The embodiment of various aspects of construction contract can be seen in the following table.

**Table 5** The Embodiment of Various Aspects in Construction Contract

No	Aspects	Commentaries
<b>Legal Aspect</b>		
1	Preamble	<ol style="list-style-type: none"> <li>1. There should be a contract title</li> <li>2. Contract should have a contract number</li> <li>3. Ensure that there shall be stated date and place of contract signing</li> </ol>
2	Type of contract	<ol style="list-style-type: none"> <li>1. Ensure whether the project is a government project or private project</li> <li>2. Ensure what type of contract procurement does the project have (traditional, design-build, EPC or else)</li> <li>3. Ensure what type of contract pricing does the project have (lumpsum, unit price, or else)</li> </ol>
3	Validity	<ol style="list-style-type: none"> <li>1. Ensure that the both parties have legality in doing business process in Indonesia (notarial act, identity card, etc)</li> </ol>
4	Contract background	<ol style="list-style-type: none"> <li>1. There is a procedure from the tendering period up to awarding period</li> <li>2. All parties agreed to sign the contract pursuant to the terms and conditions of the contract</li> <li>3. There is basis of the agreement</li> </ol>
5	Hierarchy of documents	<ol style="list-style-type: none"> <li>1. There is a clause which stipulate the hierarchy of documents</li> </ol>
6	Object of the agreement	<ol style="list-style-type: none"> <li>1. Scope of work must be stated clearly and firmly</li> <li>2. Clear time-related condition (commencement date, construction period, defect liability period, contract period, extension of time)</li> </ol>
7	Rights and obligations	<ol style="list-style-type: none"> <li>1. All rights and obligations of the parties involved should be clearly written down and balanced</li> </ol>
8	Governing law and language	<ol style="list-style-type: none"> <li>1. There should be clauses which state the governing law and language of the project</li> <li>2. All work carried out in Indonesia are subject to the Indonesian Law</li> <li>3. The contract should be written in Bahasa Indonesia</li> </ol>
9	Dispute settlement	<ol style="list-style-type: none"> <li>1. There should be clauses which describe how to settle any disputes between the parties involved</li> <li>2. Amicable settlement between parties must be prioritize</li> <li>3. Arbitration as a higher level of alternative dispute resolution should be enforced if no amicable settlement reached</li> </ol>
10	Addendum and amendment	<ol style="list-style-type: none"> <li>1. There should be a provision which provide a necessary way for both parties to make an addendum and/or amendment to the contract</li> </ol>
<b>Business Aspect</b>		
11	Contract Value	<ol style="list-style-type: none"> <li>1. The amount of contract price should be clearly stated and written (both in numbers and spellings)</li> </ol>
12	Completion time	<ol style="list-style-type: none"> <li>1. The date of completion must be clearly stated</li> <li>2. The duration of work must be clearly stated</li> </ol>
13	Extension of time	<ol style="list-style-type: none"> <li>1. Commitment to complete the works by any stipulated time must be subject to extension of time</li> <li>2. Conditions which are subject to extension of time must be clearly stated in the contract (force majeure, variations, suspensions not cause by the contractor's faults, change of law, etc)</li> </ol>

14	Working hour	<ol style="list-style-type: none"> <li>1. Examine the local regulations and practices in respect of working hours (shift work, night work, daylight work, rest days, public holidays, etc)</li> <li>2. The contract price and duration must be estimated accordingly</li> </ol>
15	Variations and claims	<ol style="list-style-type: none"> <li>1. The contract scope of work must be clearly defined without ambiguity</li> <li>2. The contract must have a definitive procedure on variations</li> <li>3. There must be rules of valuation for variations</li> <li>4. The contract should provide reasonable time bar to notify and quantify a claim or variation</li> </ol>
16	Cost of delay	<ol style="list-style-type: none"> <li>1. The contract should provide for conditions where one party must compensate for the cost of delay</li> </ol>
17	Acceptance of work	<ol style="list-style-type: none"> <li>1. The contract must have definitive acceptance procedure</li> <li>2. There should be clauses which describe the acceptance procedure and the result of the acceptance (release of retention money)</li> </ol>
18	Liquidated damages	<ol style="list-style-type: none"> <li>1. There should be a clause which imposes an obligation upon one party to pay a fixed sum of money in the event of one party's breach</li> </ol>
19	Defect liabilities	<ol style="list-style-type: none"> <li>1. The period of defect liability should be stated in the contract</li> </ol>
20	Warranties	<ol style="list-style-type: none"> <li>1. Warranties must be limited to express warranties set forth in the contract and to the extent permissible under applicable law</li> <li>2. Clear definitions of performance test procedures, tolerances, and acceptance criteria</li> </ol>
21	Nominated subcontractors and suppliers	<ol style="list-style-type: none"> <li>1. There should be clauses which describe the procedure of nominated subcontractors and suppliers appointments</li> <li>2. The contract should give a chance for the main contractor to object the nomination (giving reasonable refusal)</li> </ol>
22	Subcontracting	<ol style="list-style-type: none"> <li>1. There should be a provision which states the contractor's right and limitation to appoint subcontractors</li> <li>2. The main contractor is responsible for the subcontractors' work</li> </ol>
23	Insurance	<ol style="list-style-type: none"> <li>1. There should be a clause which provides the general requirements for insurance</li> <li>2. At least three types of insurance should be provided: <ul style="list-style-type: none"> <li>- Insurance for Works and Contractor's Equipment</li> <li>- Insurance against Injury to Persons and Damage to Property</li> <li>- Insurance for Contractor's Personnel</li> </ul> </li> </ol>
24	Progress evaluation and payment terms	<ol style="list-style-type: none"> <li>1. There should be clauses which provide the procedures to evaluate work progress</li> <li>2. There should be clauses which provide the payment procedures</li> </ol>
25	Adjustments	<ol style="list-style-type: none"> <li>1. There should be a clause in adjusting the contract value or work for changes in legislation and cost (escalation)</li> </ol>
26	Bonds	<ol style="list-style-type: none"> <li>1. There should be clauses which describe the various bonds required for the work: <ul style="list-style-type: none"> <li>- Performance bond</li> <li>- Advance payment bond</li> <li>- Other bonds</li> </ul> </li> </ol>
27	Correspondence	<ol style="list-style-type: none"> <li>1. The contract should provide a clear representative's correspondence address</li> </ol>
28	Contract Documents	<ol style="list-style-type: none"> <li>1. All contract documents should be stated clearly</li> <li>2. The priority of documents should be stipulated in a clause</li> </ol>
29	Unforeseeable physical	<ol style="list-style-type: none"> <li>1. There should be a clause which describes the definition of</li> </ol>

	conditions	unforeseeable physical conditions 2. There should be a clause which describes the procedure in case the contractor faces unforeseeable physical conditions
30	Reports and Instructions	1. Reports should be made by the contractor and be submitted to the engineer 2. Contractor should comply with the engineer's instructions 3. Instructions should be made in written form
31	Liquidated damages	1. There should be clauses which describe the rules and procedures for liquidated damages
32	Suspension and termination	1. There should be clauses which state the procedures and conditions for: - Suspension of work - Termination of the contract
33	Force Majeure	1. There should be clauses which explain what constitutes force majeure conditions, the procedures and settlement of obligations between parties involved
34	Termination	1. There should be a clause which defines the termination for both parties 2. There should be a clause which describes the procedure of termination
35	Taking Over	1. There should be clauses which describe the handing over procedure from contractor to the employer 2. Partial hand over procedure and requirements must be stated clearly if both parties agrees to have partial hand over in the contract
36	Taxation	1. Taxation should be stated whether it has already been included in the contract sum or not
37	Resource Utilization	1. The contractor is encouraged to use local materials, equipments and manpower
38	Environmental	1. Contractor in doing his work should comply with the applicable environmental laws and regulations

## 5 Conclusion

The focus of this research is the importance of standard form of construction contract which is expected to be introduced and be used in Indonesia. This is started with the definition of standard form of construction contract viz. an attempt to equalize perceptions, terms and conditions which is manifested in the form of construction contract, and is made based on the correct principles of contract, and serves as the guidance in negotiating and drafting a construction contract.

The findings show that there are at least 17 (seventeen) advantages of using standard form of construction contract against 8 (eight) disadvantages. The main benefit of the implementation of standard form is to provide education and good understanding on the principles of construction contract to the public. Currently there are still many people who do not understand how to make a correct contract and how to distribute the rights, obligations and risks appropriately. Since preparing and negotiating construction contract is part of the principle of freedom of contract, this standard form may at least serve as a guideline for people when they are starting a contract negotiation.

Meanwhile, this research has also identified 11 (eleven) challenges in adopting standard form of construction contract in Indonesia. Some of these challenges are lack of awareness and socialization, and the reluctant to change the current practices. Solution is given for each challenge which essentially tries to promote the usage and benefits of standard form of construction contract in Indonesia.

In addition, this research also examines various aspects of construction industry which will be stipulated in the form of construction contracts. There are 2 (two) main aspects i.e. legal aspect and business aspect. Business aspect consists of technical aspect, administrative aspect, financial aspect, taxation aspect, insurance aspect, socio-economic aspect, and environmental aspect. By

understanding the various aspects of construction contract, then a proposed model of standard form of construction contract can be made.

Since standard form of construction contract is a new thing to be implemented in Indonesia, further researches can be made and developed. Two of them are the various types of standard form of construction contract in Indonesia and the impacts of the implementation of construction contract standard forms in Indonesia.

## 6 References

- [1] AECOM. (2014). *Asia Construction Outlook 2014*. Singapore: Davis Langdon KPK.
- [2] Gould, N. (2006). *Standard Forms: Standardisation, Bastardisation and the Virtual Contract*. Fenwick Elliot LLP.
- [3] Lestari, I.G.A.A.I. (2013). *Perbandingan Kontrak Konstruksi Indonesia dengan Kontrak Konstruksi International*. Fakultas Teknik Universitas Islam Al-Azhar Mataram, *GaneÇ Swara* Vol. 7 No.2.
- [4] Patterson, M.R. (2010). *Standardization of Standard-Form Contracts: Competition and Contract Implications*. 52 *Wm. & Mary L. Rev.* 327 (<http://scholarship.law.wm.edu/wmlr/vol52/iss2/2>).
- [5] Rameezdeen R. & Rodrigo, A. (2014). *Modifications to Standard Forms of Contract: the Impact on readability*. *Australasian Journal of Construction Economics and Building*, 14 (2), 31-40.
- [6] Ramus, J., et al. (2006). *Contract Practice for Surveyors 4th Edition*. Oxford: Butterworth-Heinemann.
- [7] Shnookal, T. & Charrett, D. (2010). *Standard Form Contracting; the Role for FIDIC Contracts Domestically and Internationally*. *Proceedings of the Society of Construction Law Conference Australia, Perth*.
- [8] Soemardi, B.W. & Wirahadikusumah, R.D. (2009). *The Indonesian Construction Law: Challenges toward Globalization*. RICS COBRA Research Conference, University of Cape Town.
- [9] Suraji, A., et al. (2007). *The Indonesian Construction: Now and Future*. *Asia Construct Conference - 13th Conference in Korea*.
- [10] Zarabizan, Z., et al. (2013). *An Overview of Comparison between Construction Contracts in Malaysia: The Roles and Responsibilities of Contract Administrator in Achieving Final Account Closing Success*. *Proceedings of the 2013 International Conference on Education and Educational Technologies*.
- [11] *Kitab Undang-Undang Hukum Perdata Indonesia*, Penerbit Sinarsindo Utama.
- [12] Undang-undang No. 18 tahun 1999 tentang *Jasa Konstruksi*.
- [13] Undang-undang No. 30 tahun 1999 tentang *Arbitrase dan Alternatif Penyelesaian Sengketa*.
- [14] *Peraturan Pemerintah No. 29 tahun 2000 tentang Penyelenggaraan Jasa Konstruksi*.
- [15] *Peraturan Presiden Republik Indonesia Nomor 70 Tahun 2012 tentang Perubahan Kedua atas*
- [16] *Peraturan Presiden Nomor 54 Tahun 2010 tentang Pengadaan Barang/Jasa Pemerintah*.
- [17] *Keputusan Presiden No. 80 tahun 2003 tentang Pengadaan Barang dan Jasa Pemerintah dan Perubahannya*.

# Geospatial Information in Indonesia: Status, Challenges and Opportunities for Establishment, Innovation and Commercialization

<sup>1</sup>Hasanuddin Z. Abidin, <sup>2</sup>Priyadi Kardono

<sup>1</sup>Geodesy Research Group, Faculty of Earth Science and Technology, Institute of Technology Bandung (ITB), Jl. Ganesha 10, Bandung, Indonesia, hzabidin@gd.itb.ac.id

<sup>2</sup>Geospatial Agency of Indonesia (BIG), Jl. Raya Jakarta - Bogor KM. 46 Cibinong, Indonesia, priyadi.kardono@big.go.id

## Abstract

Indonesia is a huge maritime continent with the size of about 5000 km (east-west) by 2000 km (north-south). With population of about 240 millions, very rich (land and marine) resources and biodiversity, the geospatial data and information will play the important roles for sustainable development of the nation. Nowadays, geospatial information can be in many forms, such as: topographic and thematic maps, GIS (Geographic Information Systems), web-based geospatial databases, satellites images, photogrammetric images, and also coordinates vectors and displacements.

According to a recent study from the Geospatial Agency of Indonesia, about 90% of Indonesian government activities has spatial elements, and about 65% of these activities has geospatial element as primary identifier. Geospatial information will play strategic and important roles in supporting the three pillars of sustainable development, i.e. environment, social and economic developments.

In order to effectively and efficiently support the sustainable development of Indonesia, the quantity, quality and availability of fundamental and thematic geospatial information in Indonesia should be continuously improved. This paper presents and discusses the status and challenges in establishment of good and reliable geospatial information of Indonesia, and also analyzes the opportunities for innovation and commercialization of existing geospatial information. The paper will be closed with some closing remarks.

**Keywords:** *Indonesia, geospatial information, map, database, GIS, satellite image, establishment, innovation, commercialization*

## 1 Introduction

The Law of the Republic of Indonesia Number 4 Year 2011 concerning Geospatial Information (UU No. 4/2011) was approved by the Indonesian parliament on 5 April 2011, and authorized by the Indonesian president on 21 April 2011. This can be considered as a significant milestone in the history of surveying, mapping, positioning, and geospatial information development in Indonesia. In this act (regulation), geospatial is defined as the spatial aspects which indicate location, position and coordinates of objects or phenomena on, above, or underneath the Earth's surface, with respect to certain coordinate system. Geospatial data is defined as the data related to geographical location, dimension, shape, and/or characteristics of natural and man-made objects located on, above, or underneath the Earth's surface. Geospatial information is the already processed geospatial data which can be used for policy development, decision making, and/or program operation. More information related to geospatial science and technology can be seen in *Bossler et al.* (2004), *Sui* (2008), *Li et al.* (2009), and *Shellito* (2011).

Indonesia is a huge maritime continent with the size of about 5000 km (east-west) by 2000 km (north-south). With population of about 240 millions, very rich (land and marine) resources and biodiversity, the geospatial data and information will play the important roles for sustainable development of the nation. Nowadays, geospatial information can be in many forms, such as: topographic and thematic maps, GIS (Geographic Information Systems), web-based geospatial databases, satellites images, photogrammetric images, and also coordinates vectors and displacements. The important and beneficial roles of geospatial data and information has enflourished the development of geospatial sciences and technologies, and also several new knowledges, such as geospatial economy

(Whitehead and Marbell, 2013), geospatial intelligence (Bacastow and Bellafiore, 2009), and geodesign (Dangermond, 2010; Flaxman, 2010). All of this geospatial data, information, and knowledges will play strategic roles for sustainable development (see Table 1). In Indonesia, by regulation the acquisition, processing, maintenance, distribution and utilization of geospatial data and information is coordinated by the Geospatial Agency of Indonesia (Badan Informasi Geospasial, BIG).

Table 1. Geospatia information hierarchy.

INFORMATION HIERARCHY	NOTES
<b>DATA</b> ↓ <b>INFORMATION</b> ↓ <b>KNOWLEDGE</b> ↓ <b>WISDOM</b>	Distances, Angles, Heights, Depths, Coordinates, Terrestrial Photos/Images, Aerial Photos/Images, Satellite Images, etc.
	Control Networks of Coordinates/Heights/Gravity, Topographic and Thematic Maps/Databases, Geographical Information System (GIS), etc.
	Geospatial Sciences, Geospatial Technologies, Geospatial Economy, Geospatial Intelligence, Geodesign, dll
	Sustainable Development

In the following, the status and challenges in establishment of good and reliable geospatial information of Indonesia is presented and discussed. The opportunities for innovation and commercialization of existing geospatial information is also analyzed.

## 2 Roles of Geospatial Information for Development in Indonesia

Indonesia is a huge maritime continent with the size of about 5000 km (east-west) by 2000 km (north-south) with about 95,000 km of coastline length (see Figure 1). It consists of more than 17.000 islands, in which 13.466 islands have been coordinated and registered to the United Nations. Indonesia has a land area of about 1.9 million km<sup>2</sup>, and a maritime area of about 5.8 million km<sup>2</sup>, consisting of internal water (about 2.3 million km<sup>2</sup>), territorial sea (about 0.8 million km<sup>2</sup>), and Economic Exclusive Zone (about 2.7 million km<sup>2</sup>). Indonesia has an abundance of renewable (agricultural and forestry products) and un-renewable (minerals, oil, gas, geothermal, and water) natural resources, both in land and marine areas. It has also very rich (land and marine) biodiversity, and relatively large population of about 240 millions. In 2014, Indonesia has already 34 provinces, 403 districts, and 98 municipalities.

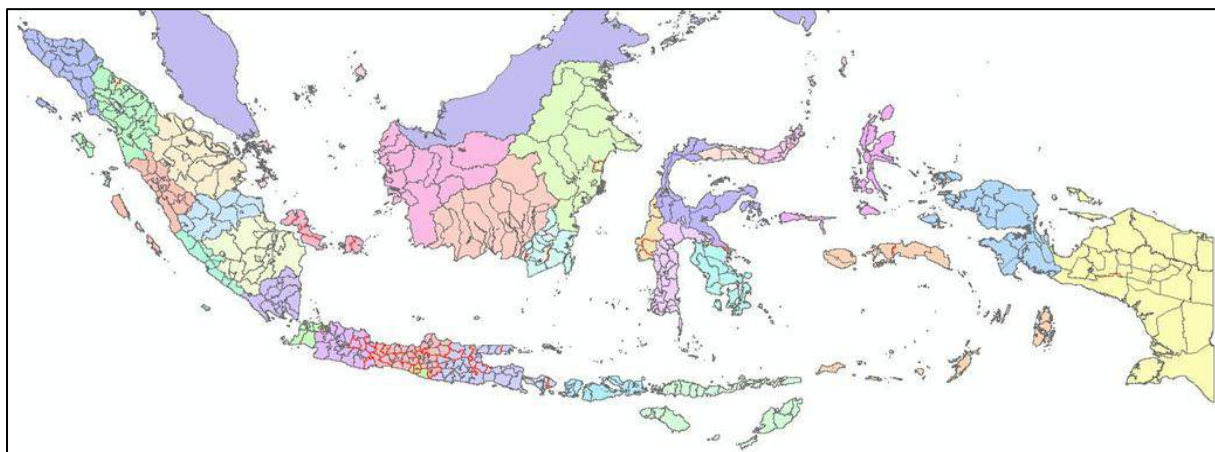


Figure 1. Maritime continent of Indonesia,

Considering the aforementioned characteristics of Indonesia, it is easy to realize that geospatial information will play strategic and important roles in supporting the three pillars of sustainable development, i.e. environmental, social and economic developments of Indonesia. Moreover, based on the study conducted by the Geospatial Agency of Indonesia in 2012, about 90% of Indonesian government activities has spatial elements, and about 65% of these activities has geospatial element as primary identifier, as illustrated in Figure 2. In this case, both fundamental and thematic geospatial datasets will be useful. In general, the sectors/areas of activities in Indonesia where the geospatial data and information will be necessary and required can be summarized in Table 2.

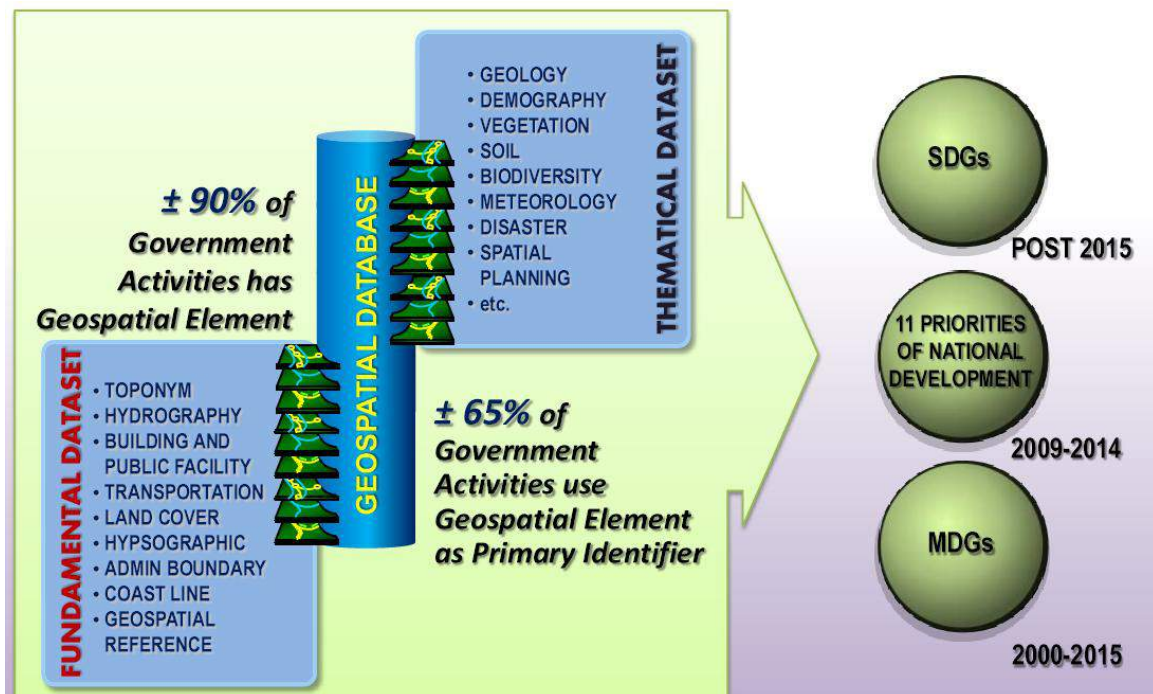


Figure 2. Strategic roles of geospatial information for development in Indonesia; courtesy of the Geospatial Agency of Indonesia.

Table 2. Examples of the activities requiring support from geospatial data and information.

No.	Sectors/Areas of Activities	Notes of potential utilization of geospatial data and information
1.	Planning, execution, and management of land-related development programs and natural resources related projects	<ul style="list-style-type: none"> <li>• Topographic and thematic mapping of land areas at various scales from 1 : 1.000 to 1 : 1.000.000</li> <li>• Land areas = 1.9 million km<sup>2</sup></li> </ul>
2.	Exploration, exploitation, and management of marine resources	<ul style="list-style-type: none"> <li>• Bathymetric and thematic mapping of marine areas</li> <li>• Marine areas = 5.8 million km<sup>2</sup></li> </ul>
3.	Land administration program	<ul style="list-style-type: none"> <li>• From about 87 million land parcels in Indonesia, only about 46% has been registered</li> <li>• Cadastral mapping of about 90% of the area (e.g. about 83 million ha) still needs to be established</li> </ul>
4.	Village mapping program	Indonesia has more than 80,000 villages.
5.	Mitigation and adation of natural hazards	Indonesia is prone toward many natural and man-made hazards, e.g. earthquake, volcanic eruption, landslide, flooding, tsunami, forest fire, land subsidence, sea level rise, and climate change.
6.	Management of international boundary regions	Indonesia has a maritime boundary with 10 countries, and land boundaries with 3 countries
7.	Boundary management of	Indonesia has 34 provinces, 403 districts, 98



	administrative areas	municipalities, and more than 80,000 villages.
--	----------------------	--

### 3 Status of Geospatial Information Establishment in Indonesia

According to regulation of UU 4/2011 concerning Geospatial Information, in Indonesia the types of Geospatial Information (GI) is categorized as shown in Figure 3. In general, geospatial information (GI) is categorized into the fundamental and thematic geospatial information. Thematic GI is usually established with reference to its related fundamental GI. Therefore in the development of geospatial information, the fundamental GI usually should be established first before the thematic GI.

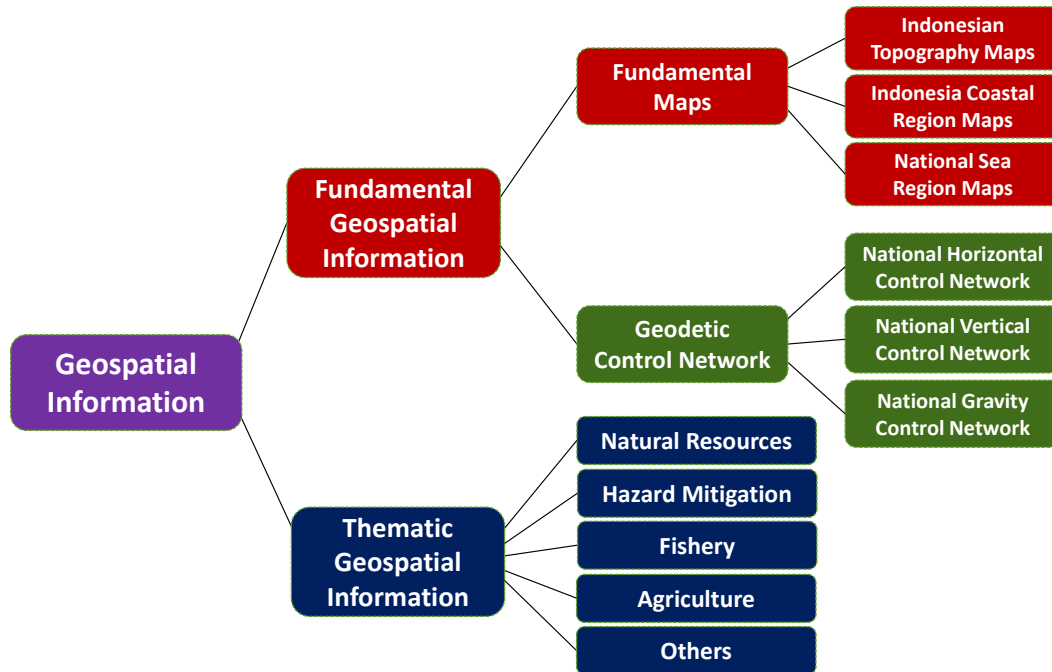


Figure 3. The types of Indonesian Geospatial Information.

In general, the GI development of Indonesia is still far from completion, both for fundamental and thematic GI. For examples, in case of topography maps, actually there are many large-scale maps ranging from 1:1000 to 1:10,000 are still need to be developed. Even with the medium-scale maps, which has been developed by BIG (previously know as Bakosurtanal) for quite a long time, still some regions are waiting to be mapped (see Figure 4).The geodetic and vertical control networks of Indonesia are also still concentrated in western part of Indonesia, as shown in Figures 5 and 6. Expansion of the networks to the eastern part of Indonesia and densification of the network are still required. More information on the status of Indonesian GI can be seen in BIG (2015).

Table 3. The availability status of the Indonesian topography maps in 2013; courtesy of BIG.

No.	Scale	Map Sheet Number (Total)	Map Sheet Number (Available)	Map Sheet Number (Not yet Available)
1	1.000.000	37	0	37
2	500.000	103	0	103
3	250.000	309	306	3*
4	100.000	1.245	0	1.245
5	50.000	3.888	2.177	1.711
6	25.000	13.020	1.774	11.246
7	10.000	91.547	780	90.767
8	5.000	283.866	0	283.866
9	2.500	880.206	0	880.206
10	1.000	2.729.319	0	2.729.319

It should be noted in this case that the geospatial information of Indonesia can be accessed through the geoportal with the following address: <http://tanahair.indonesia.go.id/home> (see Figure 7).

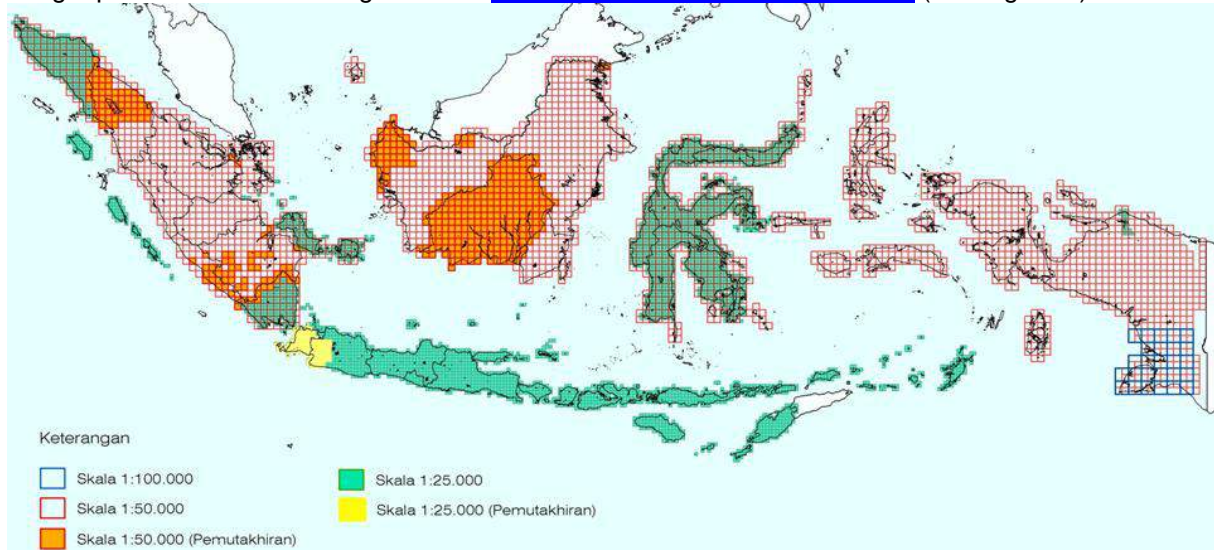


Figure 4. The availability status of the topography medium-scale maps in 2014; courtesy of BIG.

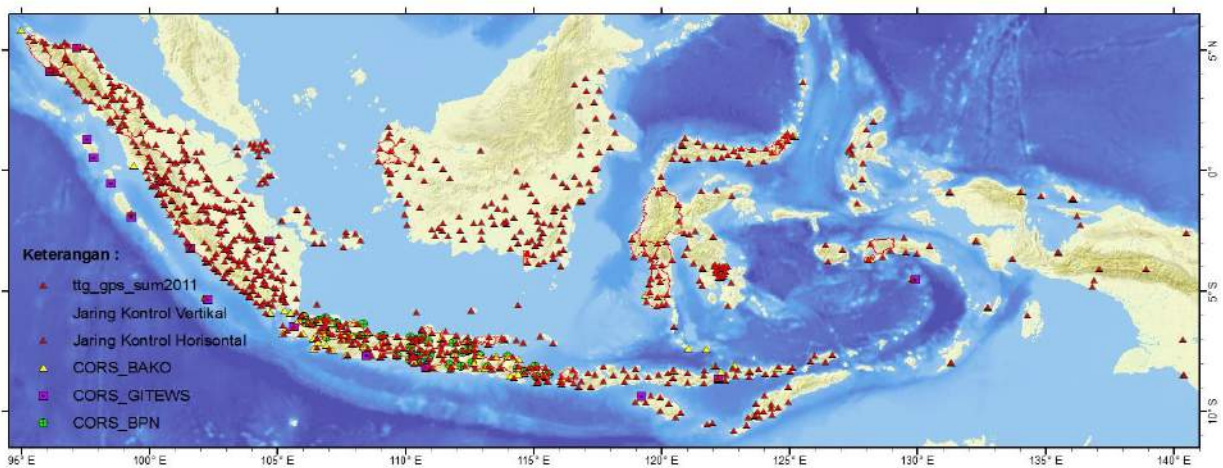


Figure 5. Status of national geodetic control network (630 first order geodetic control stations established using GPS surveys); courtesy of BIG.

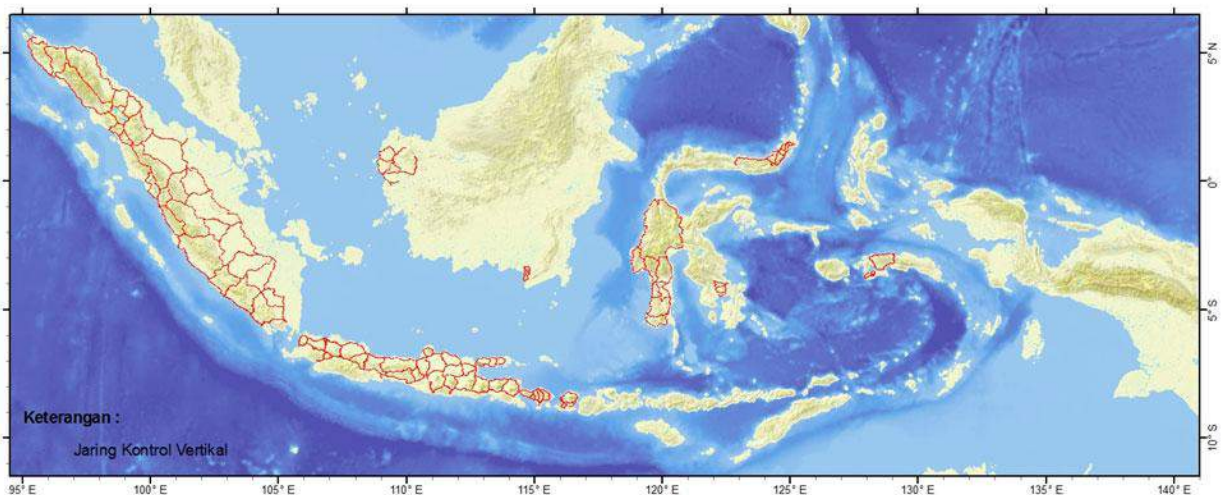


Figure 6. Status of national vertical control network  
(about 7000 geodetic height stations with spacing of about 5 km); courtesy of BIG.



Figure 7. Indonesian geoportal (<http://tanahair.indonesia.go.id/home/>).

#### 4 Challenges of Geospatial Information Establishment and Innovation in Indonesia

Based on the previous section explanation, it can be realized that the establishment of fundamental and thematic geospatial information in Indonesia is not yet completed and still need to be continue, both in land and marine areas (see also *BIG (2015)* and *Geoportal RI (2015)*). There are several challenges and constraints that have to be faced and considered in this matter, which are as discussed in the following.

- (1) The main challenge and constraint for geospatial information establishment in Indonesia is the vast region of the maritime continent of Indonesia. With the size of about 5000 km by 2000 km, consisting of so many islands, and various spectrum of topography and marine conditions, acquisition and observation of geospatial data will indeed require a lot of resources and observation times. At present times, mapping the land topography is still the main concentration of BIG, especially for larger scales of 1:1.000, 1:2.500, 1:5.000, and 1:10.000. Bathymetric mapping of the Indonesian maritime area will also be a tremendous challenge for BIG and other related institution, since its coverage is about 3 times larger than the land area. Establishing good and reliable systematic gravity data in land and marine areas of Indonesia is also another huge challenge. Finishing land gravity survey of land areas is still the main concerned of BIG. In this regard, BIG has recently conducted airborne survey gravity survey for Kalimantan, Sulawesi and Papua islands. Starting in 2016, the airborne gravity surveys will be conducted for Sumatera, Java, Bali and Nusa Tenggara islands.
- (2) Geospatial Data and Information Infrastructure (GDI) of Indonesia is incomplete yet and still under development. From the 5 (five) pillars of the Indonesian GDI as shown in Figure 8, namely institutional arrangements, standards, human resources, science and technology, and policy and regulation, the last four should be strengthened and continuously improved. Without support from good and reliable, but effective and efficient GDI, the development of geospatial information in Indonesia will take a long time to complete.
- (3) The fast and reliable GI establishment in Indonesia has to be supported by strong geospatial industry in the country. At present geospatial industry in Indonesia still need to be developed, both in terms of the number of geospatial companies, number and quality of their facilities and human resources, the supporting science and technology, and also their professionalism and



managerial skills. According to APSPIG (2015), there are 127 geospatial companies in Indonesia. Unfortunately, most of these companies are located in Jakarta and Bandung. In order to speed up the GI development in Indonesia, more geospatial companies in other region of Indonesia should be established.

- (4) The users and sectors requiring support from geospatial information in Indonesia are actually numerous, for examples positioning, navigation, surveying and mapping, cadastre, hydrography, energy and mining, disaster mitigation, agriculture and forestry, biodiversity, spatial planning, urban and rural development, transportation, public utilities, telecommunication, demography, and social mapping. At present, not all users and sectors have been satisfied by the geospatial data and information, and even the existing data and information sometimes do not match the user requirements. Link-and-match between the providers and users of geospatial data and information in Indonesia indeed has to be improved.

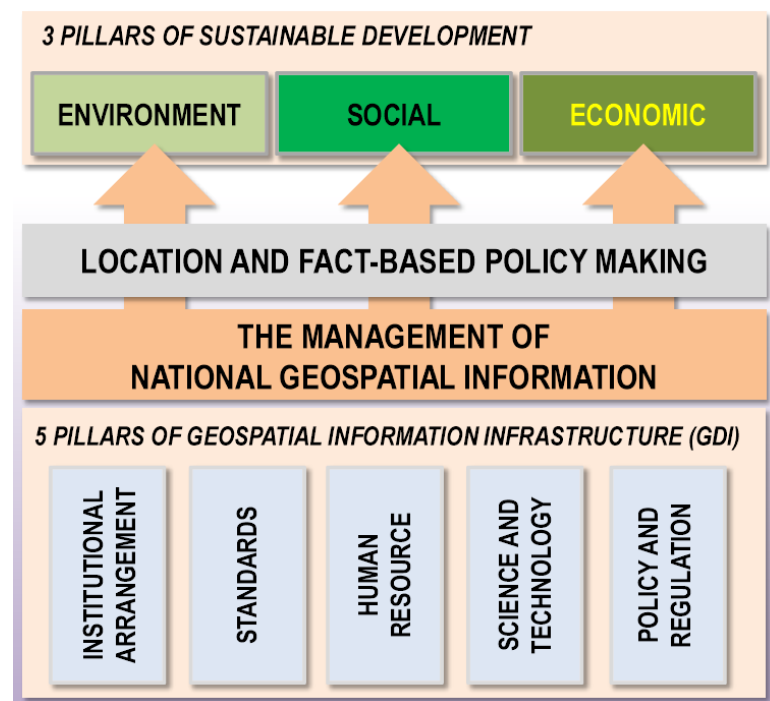


Figure 8. Roles of geospatial information for sustainable development; courtesy of BIG.

- (5) Development of geospatial data and information in Indonesia will require a lot of human resources, both in the level of technician, surveyors, geographers, geomatician, and geodesists. Technician and surveyors are usually produced by high school and diploma (vocational) levels related to surveying and mapping. The geodesists, geomatician and geographers, are usually produced by the university levels related to Geodesy, Geomatics, and Geography. In Indonesia, the study programmes of Geodesy and/or Geomatics, all are located in Java as shown in Figure 9; while study program of Geography has a wider spatial coverage. It should be noted however that study program of Geography outside Java is mostly educational in nature and aim to graduate the geography teachers for high school. Figure 9 shows also that the most eastern parts of Indonesia (e.g. Papua and Maluku) do not have a single study program on Geodesy and/or Geomatics and/or Geography.
- (6) Fast and reliable geospatial information development will also require support from the related policy, regulation, and (technical and operational) standards. Without the existence of this very important geospatial infrastructure, even the allocation of relatively large financial budget will not be effective in establishment of geospatial information. Therefore, development of those soft geospatial infrastructures should also be properly executed along with other more tangible (technical) geospatial infrastructures. The speed of geospatial information development in Indonesia usually cannot be significantly increased, since the geospatial information development is usually executed in yearly programs and not as multi-year programs. Regulation

concerning this matter should also be updated to allow more flexible and more effective execution of the geospatial related programs.

- (7) Due to rapid urban development, changes in land use and land cover, and the impacts of large natural disasters (e.g. tsunami, flooding, landslides and volcanic eruption), updating of the topography and thematic maps and related databases is quite frequently required. In this case, the challenge is to establish a rapid updating system. In general, updating period for thematic maps is usually shorter than those for topography maps.

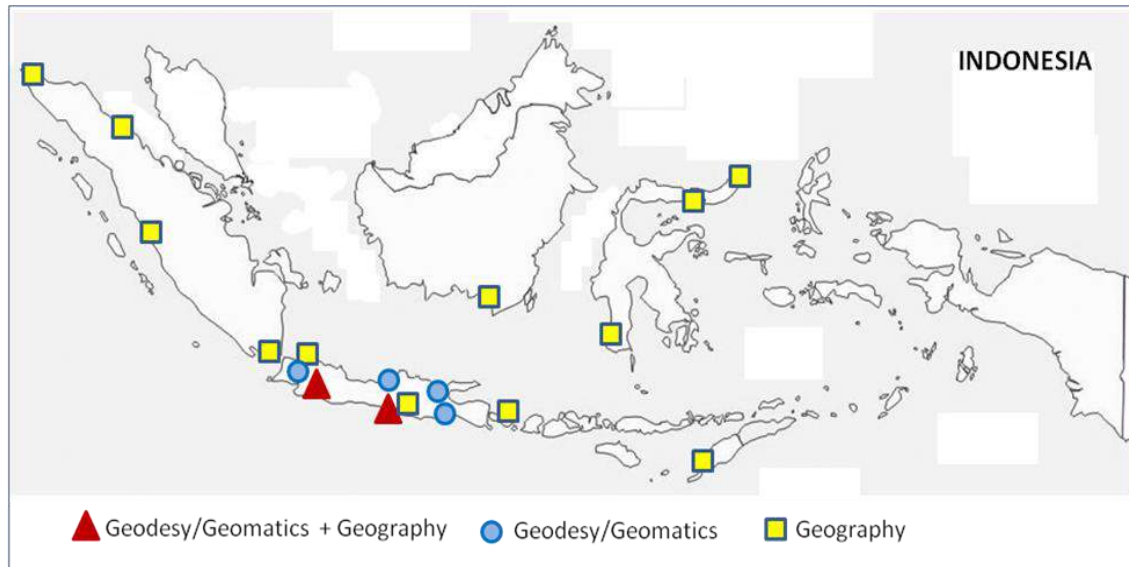


Figure 9. Location of higher learning institutions with respect to study programs of Geodesy/Geomatics and/or Geography; after Abidin and Kunaefi (2009).

- (8) In Indonesia, the fundamental topographic maps with the scales of 1:1.000 and 1:2.500 are usually made by the National Land Agency (BPN), and sometimes by certain municipalities and districts. BIG is usually concentrated on making the fundamental topographic maps with the scales of 1:25.000 and 1:50.000. However according to the regulation of UU 4/2011 then BIG is responsible for development of the topographic maps at all scales, from 1:1.000 to 1.000.000. In reality, considering the required times, human resources, and its budget allocation, it will be very difficult for BIG alone to handle all topographic mapping in Indonesia for all scales. Therefore, the good cooperation and coordination between BIG with BPN and certain municipalities/districts should be established.
- (9) The new village mapping program has been launched by the new government of Indonesia, which is intended to establish fundamental map and various thematic maps of vilagges at scale of 1:5.000. These mapas are needed for sustainable development of vilagges in Indonesia. Considering that Indonesia has more than 80,000 vilagges across 34 provinces, 403 districts, and 98 municipalities, from Aceh to Papua, it can be realized that it is indeed the tremendous challenges for all geospatial stakeholders in Indonesia. In this case, related mapping standards and SOP (standard of procedures), and also related databases and portal, should be established as soon as possible. Related human resources, especially in the level of surveyors, operators, and technicians should also be prepared in large numbers with relatively good quality. The cooperation and coordination with BPN and related municipalities/ districts is also important and necessary.
- (10) At present times, there are online provider of earth surface representation such as Google Earth (<https://www.google.com/earth/>) and Google Maps (<https://maps.google.com/>), which their product are freely available for the public. If the complete Indonesian geospatial data and information cannot be easily and freely available through internet, then most peoples will instead use the products provided by Google Earth and Google Maps. The challenge in this case is to

make the Indonesian geoportal (<http://tanahair.indonesia.go.id/home/>) better than Google Earth for the Indonesian region.

## 5 Opportunities of Geospatial Information Innovation and Commercialization in Indonesia

Although many challenges and constraints that have to be faced and considered in establishment of good and reliable geospatial data and information in Indonesia, the opportunities are also promising. There are several conditions nowadays that can be considered as opportunities and positive points for the geospatial information development in Indonesia, which are presented in the following.

- (1) Acquisition, processing, presentation and visualization of geospatial data and information at present times are greatly improved by the fast development in geospatial related systems and technologies, such as: satellite and terrestrial based positioning, surveying and mapping technologies, earth satellite observation systems, photogrammetric systems, GIS (geographical Information Systems), and also information and communication technologies. Information related to the geospatial related systems and technologies can be seen in *Bossler et al. (2004)*, *Sui (2008)*, *Li et al. (2009)*, and *Shellito (2011)*.

At present times, the Global Navigation Satellite Systems (GNSS) which is widely used for positioning, surveying and mapping are developing in good speed, both related to space and user system segments (*Hofmann-Wellenhof et al., 2008*). Gradiometry and Satellite Altimetry satellites for earth gravity observations on land and sea areas are also becoming more powerful and accurate (*Kenyon et al., 2012*). Remote sensing platforms for Earth Observation (EO) nowadays are also quite numerous, from the altitudes of several metres to several ten thousand kilometres above ground up, as shown in Table 4. Example of several Earth observation satellites are shown in Figure 10.

Table 4. Remote Sensing platforms, from *Li et al. (2009)*

Platforms	Altitudes	Applications
Geostationary satellites	36,000 - 40,000 km	EO for a given location
EO satellites (Polar orbit)	500 - 1,000 km	EO for a given period
Space shuttles/Space Lab	240 - 350 km	EO, space experiments
Near space Boat	20 - 100 km	EO for a given Location
Tele-detection unmanned aircraft	100 m - 100 km	inventory
Super-altitude jets	10,000 - 12,000 m	military reconnaissance
Middle-low altitude airplane	500 - 8,000m	aerial photogrammetry
Aeroboat	500 - 3,000 m	military reconnaissance
Helicopter	100 - 3,000 m	photogrammetry
Tele-detection airplanes	Less than 500 m	photogrammetry
Glider	50 - 500 m	photogrammetry
Balloons	Less than 800 m	inventory
Ropeways	10 - 40 m	heritages
Cranes	5 - 50 m	ground-truthing
Mobile mapping vans	0 - 30 m	ground-truthing

- (2) Applications of geospatial data and information for sustainable development of vast continent maritime of Indonesia are actually tremendous, as indicated in Figures 2 and 11. For sustainable development of Indonesia, it can be expected that there will be many interests in social, economy and environment sectors in which geospatial data and information can play significant roles and contributions (see examples given in previous Table 2). The conflicts among the sectors will usually also require geospatial data and information for their conflict resolution. This wide spectrum of user needs is a golden opportunity for geospatial data and information providers in Indonesia.
- (3) Public awareness about geospatial information and its importance is increasing rapidly nowadays in Indonesia. This awareness is driven partly by the availability of GPS and Google Maps in most Android-type mobile phones and gadgets along with the increase in reliability and coverage of

mobile internet services. The increasing use of geospatial related illustration/sketch/map by the newspapers, televisions, and social media is also driving this good public awareness of geospatial information in Indonesia. This is a good opportunity for geospatial entrepreneurs in Indonesia to develop geospatial industry with various innovation and commercialization initiatives and programs.

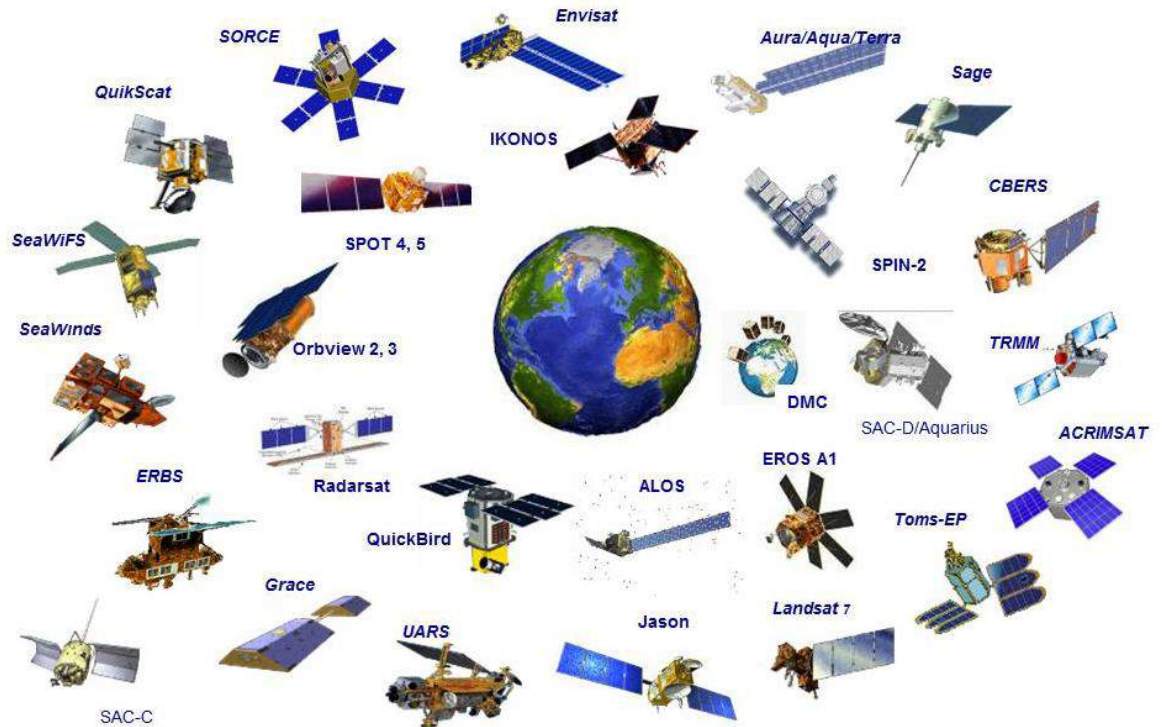


Figure 10 . Example of several operational Earth observation satellites, from Earthzine (2015).

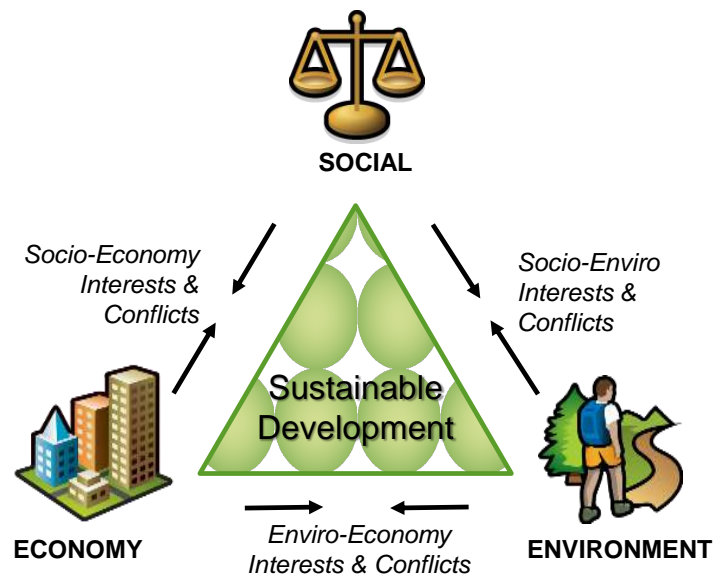


Figure 11. Potential areas of applications for geospatial data and information in Indonesia.

- (4) Public awareness about geospatial information and its importance is increasing rapidly nowadays in Indonesia. This awareness is driven partly by the availability of GPS and Google Maps in most Android-type mobile phones and gadgets along with the increase in reliability and coverage of mobile internet services. The increasing use of geospatial related illustration/sketch/map by the newspapers, televisions, and social media is also driving this good public awareness of



geospatial information in Indonesia. This is a good opportunity for geospatial entrepreneurs in Indonesia to develop geospatial industry with various innovation and commercialization initiatives and programs.

- (5) One map policy, declared by the previous Indonesian president Susilo Bambang Yudoyono in the cabinet meeting of 23 December 2010 and reiterated by the new government of president Joko Widodo, is indeed a good momentum and opportunity to establish a reliable nation-wide geospatial information infrastructure in Indonesia. One-map policy will require single and unified geospatial reference, standards, database and geoportal. This is an opportunity for BIG and geospatial community to play more strategic roles in various sustainable development programs of Indonesia.
- (6) New government of Indonesia has launched the new village mapping program. These villages' maps will play important roles for several purposes, such as: village spatial planning, village development, village boundary establishment, and village budget allocation from central government. Considering that Indonesia has more than 80,000 villages, and the maps will produced at scale 1: 5,000, it can be realized that it is indeed the tremendous opportunities for geospatial industry in Indonesia. Besides related GIS, databases and portal, this program can be expected to drive other innovative applications and initiatives related to sustainable village development and perhaps event smart villages in the future.
- (7) Considering the tremendous potential applications and increasing public awareness related to geospatial data and information in Indonesia, then the future of the Indonesian geoportal (<http://tanahair.indonesia.go.id/home/>) is actually very promising. In order to have good and wide commercialization impacts, then this geoportal should be managed as professional as possible. In this case the way Google Earth is managed can be used as a good example.
- (8) The development of new knowledges in geospatial, such as geospatial economy (*Whitehead and Marbell, 2013*), geospatial intelligence (*Bacastow and Bellafiore, 2009*), and geodesign (*Dangermond, 2010; Flaxman, 2010*), will also introduced opportunities of application in Indonesia. Considering the relatively large economic size of Indonesia, large population, rapid urban and development process, vast land and maritime territory, and strong military and police forces; the applications of those new knowledges in Indonesia are indeed very promising.
- (9) Geospatial data and information in various digital 3D types will have good potential contributions for the development of smart cities (*Blaschke et al. , 2011; Tao, 2013; and Li et al. 2013*). In Indonesia, the initiatives for smart cities program is started to be enflourished (*Futuregov, 2015*). According to a recent study, in 2025 about 57% of Indonesian population will be living the urban areas (cities), which in this case is involving about 98 cities all over Indonesia. If all those cities will be managed using smart city paradigm, then the availability of good and reliable urban geospatial data and information in Indonesia should be developed from now on.

## 6 Closing Remarks

Geospatial data and information, in its various types and scales, will play very important and strategic roles for sustainable development of Indonesia, both in land and marine regions. Although at present times, the establishment of good and reliable geospatial data and information in Indonesia is still far away from completion, with many challenges and constraints to be overcome, however the opportunities for innovation and commercialization is also wide open.

In order to establish good and reliable system, infrastructure and applications of geospatial information in Indonesia, good and conducive cooperation and coordination among the geospatial information stakeholders has to be established. In this case, the geospatial stakeholders such as BIG, BPN, provinces/districts/municipalities, geospatial industry, education institutions, and community, have to work hand in hand in order to realize the better geospatial information world of Indonesia.



## 7. References

- Abidin, H.Z. and Tresna D. Kunaefi (2009). Natural Hazards and Higher Education in Indonesia, *Educationist*, ISSN: 1907-8838, Vol. III. No. 1/Januari, pp. 1-8.
- APSPIG (2015). Website of *the Association of Surveying, Mapping, and Geospatial Information of Indonesia* (Asosiasi Perusahaan Survei Pemetaan dan Informasi Geospasial, APSPIG). URL: <http://www.apspig.com/>. Accessed: 17 March 2015.
- Bacastow, T.S., and D.J. Bellafiore (2009). Redefining Geospatial Intelligence. *American Intelligence Journal*, Fall, pp. 38-40.
- BIG (2015). Website of *the Geospatial Agency of Indonesia* (Badan Informasi Geospasial, BIG). URL: <http://www.big.go.id/>. Accessed: 16 March 2015.
- Bossler, J.D., J.R. Jensen, R.B. McMaster, and C. Rizos (Eds.) (2004). *Manual of Geospatial Science and Technology*. CRC Press. 808 pp.
- Dangermond, J. (2010). GeoDesign and GIS—Designing our Futures. *Peer Reviewed Proceedings of Digital Landscape Architecture*, Anhalt University of Applied Science, Germany, pp.502-514.
- Earthzine (2015). Website of Earthzine. Intended for Fostering Earth Observation and Global Awareness. URL: <http://www.earthzine.org/wp-content/uploads/2011/09/Satellites.jpg>. Accessed: 18 March 2015.
- Flaxman, M. (2010). Fundamentals of Geodesign. *Proceedings of Digital Landscape Architecture*, Anhalt University of Applied Science, pp. 28-41.
- Futuregov (2015). Indonesia to spend US\$2.4 million on smart city project in 2015. News on Futuregov website, <http://www.futuregov.asia/articles/5970-indonesia-to-spend-us24-million-on-smart-city-project-in-2015>. 7 January 2015
- Geoportal RI (2015). Webside of *the Indonesian geoportal*, URL : <http://tanahair.indonesia.go.id/>. Accessed: 16 March 2015.
- Hofmann-Wellenhof, B., H. Lichtenegger, E.Wasle (2008). *GNSS - Global Navigation Satellite Systems: GPS, GLONASS, Galileo, and more*. ISBN 978-3-211-73012-6, Springer Wien New York, 516 pp.
- Kenyon, S.C., M.C. Pacino, and U.J. Marti (2012). Geodesy for Planet Earth, International Association of Geodesy (IAG) Symposia No. 136, Proceedings of the 2009 IAG Symposium, Buenos Aires, Argentina, 31 August - 4 Sept. 2009, Springer-Verlag Berlin Heidelberg, 1046 pp.
- Li, D., J. Shan and J. Gong (eds.) (2009). *Geospatial Technology for Earth Observation*. ISBN 978-1-4419-0049-4. Springer New York, 556 pp.
- Li, D., J. Shan, Z. Shao, X. Zhou and Y. Yao (2013). Geomatics for Smart Cities-Concept, Key Techniques, and Applications. *Geo-spatial Information Science*, 16(1), 13-24.
- Blaschke, T., G.J. Hay, Q. Weng, and B. Resch (2011). Collective sensing: Integrating geospatial technologies to understand urban systems - an overview. *Remote Sensing*, 3(8), 1743-1776.
- Shellito, B. A. (2011). *Introduction to Geospatial Technologies*. ISBN-13: 978-1-4292-5528-8, Macmillan Higher Education, England. 523 pp
- Sui, D. Z. (Ed.) (2008). *Geospatial Technologies and Homeland Security*. ISBN: 978-1-4020-8339-6 Springer Netherlands, 378 pp.

Tao, W. (2013). Interdisciplinary urban GIS for smart cities: advancements and opportunities. *Geospatial Information Science*, 16(1), 25-34.

Whitehead, J., and W. Marbell (2013). "The economic benefits of geospatial technology." *Position IT*, June, pp. 43-52.

## PROTOTYPE OF ORDINAL RANK LIST APPLICATION AT PANGKALPINANG HIGH ATTORNEY BABEL

Sujono <sup>1)</sup>, Burham Isnanto <sup>2)</sup>, Ellya Helmud <sup>3)</sup>

- <sup>1)</sup> STMIK Atma Luhur Pangkalpinang, [Jono@Atmaluhur.ac.id](mailto:Jono@Atmaluhur.ac.id), 081929082936  
<sup>2)</sup> STMIK Atma Luhur Pangkalpinang, [Burham@Atmaluhur.ac.id](mailto:Burham@Atmaluhur.ac.id), 085292016258  
<sup>3)</sup> STMIK Atma Luhur Pangkalpinang, [EllyaHelmud@Atmaluhur.ac.id](mailto:EllyaHelmud@Atmaluhur.ac.id), 081995307296

### ABSTRAK

Adanya kendala di kejaksaan tinggi Pangkalpinang dalam menampilkan daftar urutan kepangkatan pegawai masih manual yang ditampilkan di media kertas dan ditempel di dinding sehingga jika ada kenaikan pangkat dari salah satu pegawai, maka urutan akan diubah seluruhnya. Hal itu menjadi latar belakang perlunya dibuat sistem data urutan kepangkatan. Metode yang dilakukan adalah pengumpulan data menggunakan observasi dan wawancara, metode analisa sistem menggunakan UML berorientasi objek, pembuatan ERD untuk perancangan basis data, dan membuat aplikasi menggunakan sistem waterfall. Metode pengujian aplikasi menggunakan Focus Group Discussion (FGD) dengan stakeholder di kejaksaan tinggi. Hasil akhirnya adalah dibuatnya aplikasi DUK untuk diimplementasikan di kantor kejaksaan tinggi agar dapat memberikan kemudahan dalam mengatur urutan kepangkatan pegawai dan pengecekan kenaikan pangkat dan gaji pegawai

*Kata kunci: FGD, Aplikasi DUK, Waterfall, Kepangkatan, Kejaksaan Tinggi*

### ABSTRACT

Constraints on the Pangkalpinang high attorney in displaying the ordinal rank list of employees that still manually using paper media and pasted on the wall so that if there is a promotion of one employee, then the order will be changed entirely. It becomes the background we need to make ordinal rank list system. The method used is data by observation and interviews, analysis methods using UML object-oriented system, ERD making for database design, and create applications using waterfall system. Application testing method using Focus Group Discussion (FGD) with stakeholders in the high attorney. Final result is an ordinal rank list application (DUK) that ready to be implemented at the high attorney office in order to provide convenience in managing employees and checking the rank order of promotion and salary

*Keywords: FGD, Ordinal rank list, Waterfall, Ranks, high attorney*

## I INTRODUCTION

Almost all areas of business, education and government need information technology. Information technology used in various fields is urgently needed to speed up the process and performance of an agency or a company, especially with regard to information systems. Without technology, it takes time and great effort finish our daily activity. By utilizing the information system, the activities / processes can be run quickly and efficiently.

Pangkalpinang high attorney is a prosecutorial agency based in the capital of Bangka Belitung province. There is problem in displaying employees rank list that still using manual sequence shown in the media of paper and taped to the wall. If there is a promotion of one employee, then the order will be changed entirely. Therefore, it is necessary to build a system to resolve the issue that is expected to provide convenience in managing employees and checking the rank order of promotion and salary. This research purpose is to analyze and help find solutions for the rank list problems at Pangkalpinang high attorney, rank list application is expected to be implemented and used in order to optimize the performance of the system, and rank list application is expected to be applied and developed by other governmental agency. There are several problem formulation in this research: is the time to be more effective and efficient after using rank list applications? , is this ranks list applications make staff work more easy and productive? , and what is the FGD test result?

## II METHODOLOGY

The research method is to describe how to gather information or data that is needed as a material for preparing this research are as follows:

### 2.1 Data Collecting Methode

Data collecting methode in this research using:

- a. Observation. This activity is conducted to collect data by direct observation with matters pertaining to outpatient as well as input for this study.
- b. Interview. Studying and analyzing the current system and get the data directly from the source to the debriefing, and is expected to interview obtained information can actually be justified on the proposed statement.
- c. Study Library. Done by reading books related to this information system. The research literature is theoretically very helpful in making this study.

### 2.2 System Analysis

One approach to systems development is object oriented analysis. Object oriented approach comes with engineering tools system development so that the result will be able to object-oriented systems that can be well defined and clear. Activities done at this stage are <sup>(Jogiyanto, 2003):</sup>

- a. Analyze existing system, ie understanding the business processes running system in order to identify the problems that exist.
- b. Analysis of the document, which specifies the input is used, the existing database, process and outputs, in order to understand the need for new documents.

<sup>(Nugroho, 2007)</sup> Unified Modeling Language (UML) diagram as a tool to analyze the system for describing business processes running system and decrypt the new system concept will be developed. Some of the diagram are:

- a. Activity Diagrams: Activity Diagrams are used to model a workflow or workflow business processes and activities within a process sequence.
- b. Use Case Diagram: to explain the benefits of the system when viewed in the eyes of people who are outside the system or actor. Use Case Diagram is also a description of the function of the system to be developed.
- c. Use Case Description: used to describe the details of the Use Case Diagram.

## III DISCUSSION

### 3.1 System Design

We use UML for system design because UML (unfied Modeling Language) is a very powerful tool in the object-oriented system development world because UML provides a visual modeling language that makes it possible for developers to create a blueprint of the system on their vision in the form of a standard, easy to understand and is equipped with an effective mechanism for sharing and communicate their designs with others. Grady Booch method very well known by the name of Object Oriented Design method. This method makes the process of analysis and design into four iterative phases, namely the identification of classes and objects, semantic identification of object relations and the class, interface details and implementation. Excellence Booch method is in detail and rich with notation and elements

### 3.2 Object Oriented Analysis

<sup>(Sutopo, 2003)</sup> Object oriented analysis (OOA) begins by stating a problem, analysts to create real-world situations models, describe the essential properties. <sup>(Utomo, 2011)</sup> In analyzing a system, the analyst must work with those who need the system to understand the problem clearly.

- a. Activity Diagrams, Activity diagrams describe business processes and sequence of activities in a process, which is used in business modeling to show the sequence of the business process activities as beneficial to help understand the overall process in modeling a process.
- b. Use Case Diagram, Use case diagrams describe the system requirements from the perspective of the user and focuses on the process of computerization. A use case can describe the relationship between the use case with actors. In common use case is a pattern of behavior of the system and order-related transactions carried out by a single actor.
- c. Class Diagram, Class is a specification that if implemented will produce an object and is at the core of development and object-oriented design. Class represents the state (attributes / properties) of a system, while offering services to manipulate the situation (method / function). Class diagrams describe the structure and description of the class, package and objects and their relationships to one another such as containment, inheritance, associations, and others-lain. Class has three principal areas, namely the name (and stereotypes), attributes, and methods

### **3.3 Designing Database**

(Widjajanto,2001) Designing conceptual models need to be done in addition to designing physical models. In the conceptual design will show entities and relationships based process desired by the organization.

- a. Entity Relationship Diagram (ERD), ERD is a graphical notation in conceptual data modeling that describes the relationship between the data store. Used to model data structures and relationships between data.
- b. Relation, Relationships are used to define and illustrate the conceptual models in detail with the primary key and foreign key
- c. Screen design of information systems, The design of the display of this information system created to design a draft document that will produce output and output design and structure of the information system display.

### **3.4 Process Analysis**

Description of the data collection process in the high court as a reference Pangkalpinang analysis are as follows:

- a. Employee data collection process, In addition to employee data recorded in this process, employees need to provide a color photo 3x4 size as a complement employee personal data.
- b. Documenting process ranks, documenting rank to determine the employees rank list.
- c. Sorting the data collection process rank, all employees data that have been recorded and then printed out and taped to the wall space personnel.
- d. Employee reporting process, making a report based on the employees rank order ranging from the highest to the bottom.

### 3.5 Proposed System

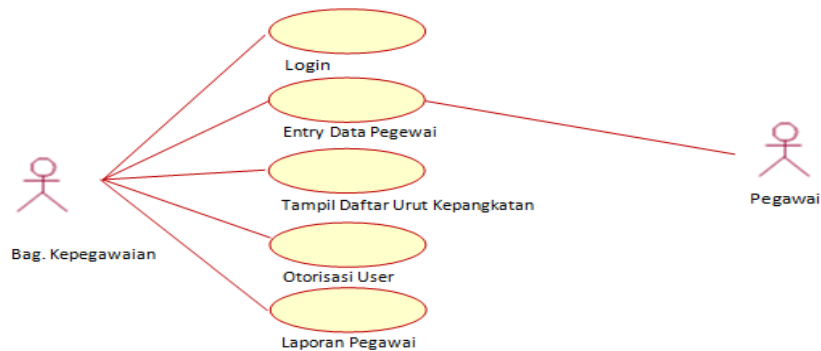


Figure 1. Use case diagram

Use case diagrams are used to describe the need and system functionality from the point of view of the user based on the analysis that has been done.

Computerized system requires a database to store data that is inputted. It is necessary to provide a good data base formation. The analysis results of the data collection form ERD database with the following models

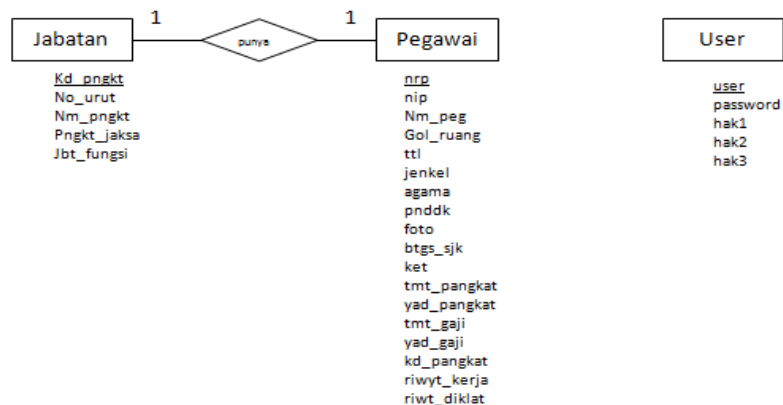


Figure 2. Entity Relationship Diagram

At the application implementation time, its need attributes as a container to hold data temporarily. From the above data base design produces design attributes with the following class diagram models



Figure 3. Rancangan Class Diagram

Rank list application display structure as follow:

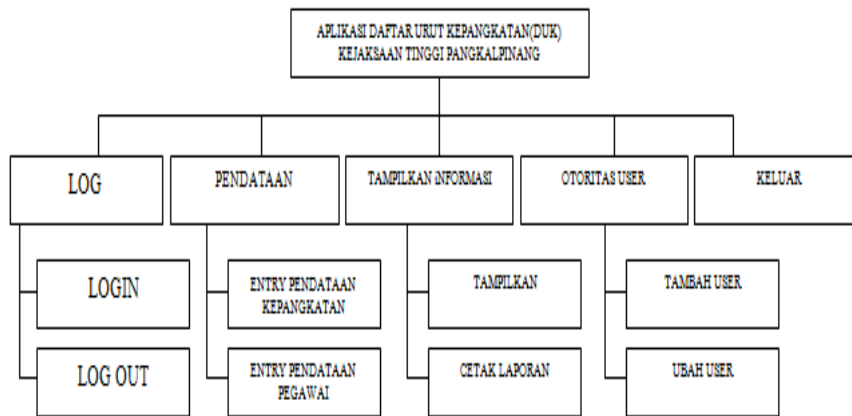


Figure 4. Struktur Tampilan Aplikasi Daftar Urut Kepangkatan

### 3.6 User Interface

The main menu screen display rank list application, before entering into the system must login first, because there are several sub-menus that should not be accessed by anyone.

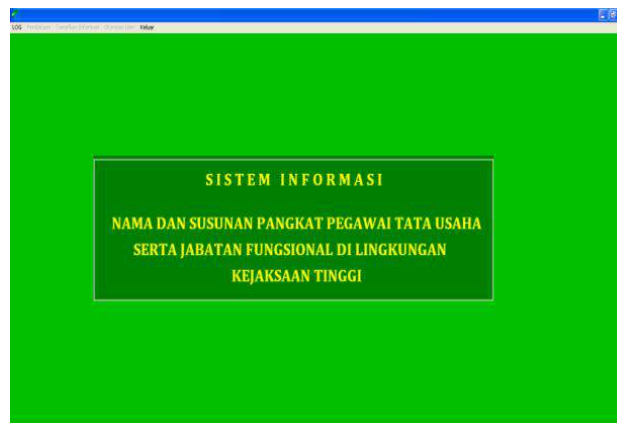


Figure 5. Layar Menu Utama

Display the login screen, the user before entering the system must login first premises fill user name and password that are already registered.

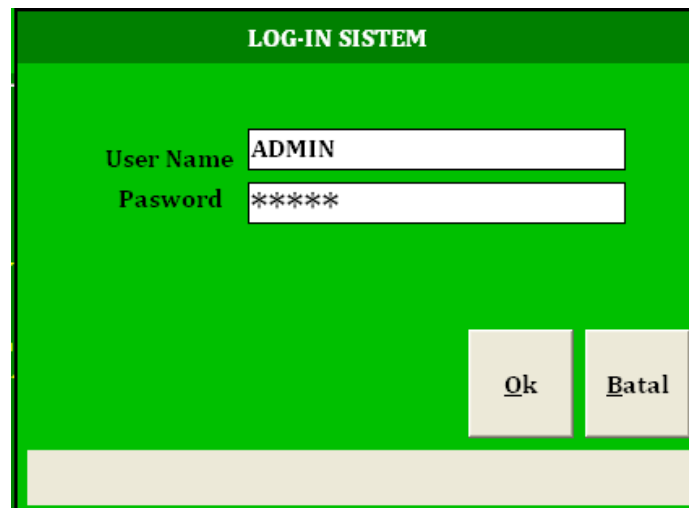


Figure 6. Layar Login

Data entry screen

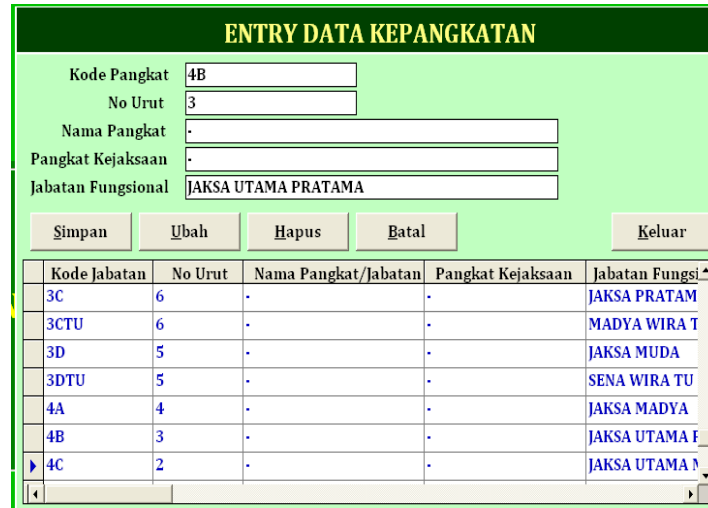


Figure 7. Layar entry data kepangkatan  
 Employee data entry screen, all employee data and photos input through this module.



Figure 8. Layar entry data kepangkatan

Rank list screen display sequence employee list rank, employee will display the data stored in the database that has been repeated 5 lines per screen in the order starting from position and the highest bracket to the bottom and there are also checking the date when a promotion and a raise, if it is almost the date (3 months prior to the date of promotion and salary increase dated 1 month) then the system will give you a sign that when clicked will display the employee data to be promoted or increased salary

KEJAKSAAN TINGGI KEPULAUAN BANGKABELITUNG << COPYRIGHT 2014 >>

NO FOTO*	NAMA PEGAWAI	* PANGKAT
1	HIDAYATULLAH, S.H., M.H. 196205041989031003	JAKSA UTAMA MADYA IV/d
2	SADIMAN, S.H., M.H. 196108051984121002	JAKSA UTAMA MUDA IV/c
3	PANJAITAN SIMANIHURUK, S.H., M.H. 195711101987031001	JAKSA UTAMA PRATAMA IV/b
4	ARIEFSYAH MULIA SIREGAR, S.H., M.H. 196403131991031001	JAKSA UTAMA PRATAMA IV/b
5	DEWI APRILYANTI, S.H. 197004121994032004	JAKSA UTAMA PRATAMA IV/b
6	TIMBUL PASARIBU, S.H. 196212111989031003	JAKSA UTAMA PRATAMA IV/b

Figure 9. Layar tampil daftar urut kepangkatan



Display screen of rank report. Will display a list of employees sorted by rank and class.



Figure 10. Layar Cetak Laporan Kepangkatan pegawai

### 3.7 System Testing

Application testing using focus group discussion methods. Researchers prepare a form containing a list of functional requirements specification system built. The focus of the discussion is to validate the functional needs of the developed software in accordance with the specification requirements specified in the analysis stage. Implementation of the FGD or discussion focused in this study was attended by participants that are selected based on the criteria mentioned earlier. Moderator and reporter functions performed by researchers. At the beginning of the FGD, researchers conducted a presentation application model that has been developed and explains every function based instruments that have been prepared. Furthermore FGD participants provide information, feedback and approval. For purposes of analysis of the test results, further research makes conclusions based on the results of the FGD. As FGD results we concluded that the application made already meet the expectations stackholder with very good results.

## IV CONCLUSION

Some of the conclusions derived from the analysis as follows:

- After using this application, all employee data more secure and tidy. Work makes rank list also become more efficient and effective because it does not need to change all of the data members of Aceh.
- The application clearly makes employees work easier and more productive because the computerized system can minimize the errors that occurred. Checking the date of promotion and salary increase can be controlled by the system.
- The test results demonstrate the application of FGD application to be approved by all stackholder and got a very good assessment.

Suggestions from the results of this analysis are:

- Need training or special training for the user to use this new application system.
- Need to make a back up data regularly as a backup master data.
- This paper is far from perfect, the need for further research to improve the weaknesses in this study.

## V REFERENCES

- Jogiyanto. (2003). Sistem Teknologi Informasi. Yogyakarta: ANDI Yogyakarta.
- Nugroho, Adi.(2007). Analisis & Perancangan Sistem Informasi Dengan Metodologi Berorientasi ObjekEd.Revisi, Informatika.
- Sutopo, Hadi, Ariesto.(2003).Analisis dan Desain Berorientasi Objek, J&J Learning-YGK.
- Utomo, Herry, Wiranto.(2011). Pemodelan Basis Data Berorientasi Objek. Andi Publisher.
- Widjajanto, Nugroho. (2001). *System Analysis and Design Methods*. 6th ed. New York : McGraw-Hill.

## STRUCTURAL, OPTICAL AND ELECTRICAL PROPERTIES OF NI-DOPED COO THIN FILMS PREPARED BY SPRAY PYROLYSIS METHOD.

M. M. Islam<sup>1</sup>, M. G. M. Choudhury<sup>2</sup>, M. M. Rahman<sup>3</sup>, M.K.R. Khan<sup>3</sup>, M. Shahjahan<sup>4</sup>, K. Uddin<sup>5</sup>  
M.A.R. Sheikh<sup>1</sup>

<sup>1</sup>Bangladesh Atomic Energy Regulatory Authority, Dhaka-1207. Bangladesh

<sup>2</sup>Department of Electronics and Telecommunication Engineering, Daffodil International University, Bangladesh

<sup>3</sup>Department of Physics, Rajshahi University, Rajshahi- 6205, Bangladesh

<sup>4</sup> Department of Applied Physics, Bangabandhu Sheikh Mujibur Rahman Science and Technology University, Gopalganj-8100, Bangladesh.

<sup>5</sup>Department of Physics, Jagannath University, Dhaka-1100, Bangladesh

### Abstract

Ni-doped and un-doped Cobalt oxide thin films were deposited on to a glass substrate at 300<sup>o</sup>C substrate temperature by spray pyrolysis method. Structural, optical and electrical properties of the films were studied. X-ray diffraction studies exhibit the amorphous nature of the as-deposited films but on annealing film become polycrystallinity as indicated by the appearance of highly resolved characteristics peaks on the spectrum. The structure of the material was found to be cubic with lattice constant  $a \approx 4.0 \text{ \AA}$ . Surface morphology of the films were studied by Scanning Electron Microscopy (SEM). The micrographs show that the surface is smooth, uniform and scattered nano-fibre around well defined nucleation centre. The spectral absorption coefficient ( $\alpha$ ) of the Ni-doped cobalt oxide films at the fundamental absorption region was calculated from transmittance and reflectance spectra. The direct and indirect band gap energies for the material were determined and the values obtained varies from 1.428 eV to 1.504 eV and 1.212 eV to 1.4 eV respectively depending on Ni concentration of the film. The Hall Effect measurements show that Ni-doped cobalt oxide is a p-type semiconductor and the carrier concentration is of the order of  $10^{19} \text{ cm}^{-8}$ . Activation energy of Ni-doped cobalt oxide calculated from resistivity measurements made in the temperature range of 300 to 450 K. It was found that there are two activation regions, in the lower temperature region,  $\Delta E_1$  varies from 0.109 eV to 0.207 eV and in the higher temperature region  $\Delta E_2$  varies from 0.173 eV to 0.432 eV depending on Ni-concentration in the film.

### 1. INTRODUCTION

Interest on Ni-doped cobalt oxide has grown from the works of cobalt oxides and nickel oxides. These materials have many interesting properties of practical applications.

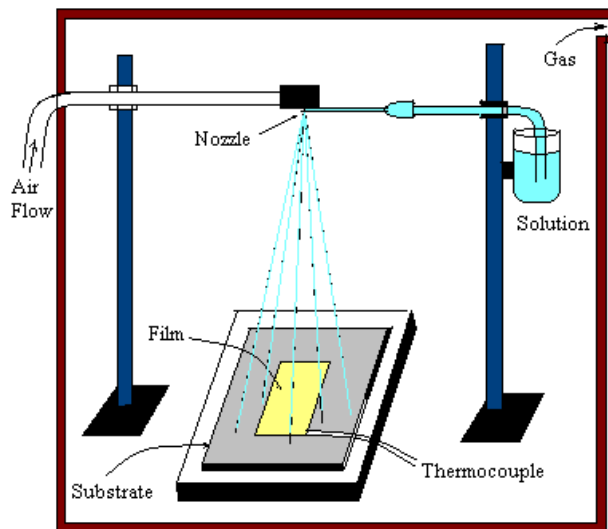
Cobalt oxide has the properties of optical non-linearity [1], gas sensing capabilities and solar energy reflecting properties [2]. Nickel oxide has the property of high optical transmission in the visible region. Attempts are made to use this property in electromagnetic window application [3],

as p-type transparent conducting films [4], a functional sensor layer for chemical sensors [5] or as photocathode for solar cell [6]. Cubic nickel oxide has also been investigated with respect to electrical properties [7] and its conduction mechanism [8].

In the present work cobalt oxide was doped with nickel for applications intended originally for nickel oxide and cobalt oxide. The idea is to maintain the high transparency of the film and at the same time to increase its conductivity so that the material can efficient be used for solar cell electrodes.

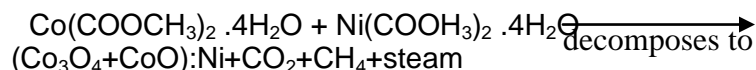
## 2. EXPERIMENTAL

Ni-doped cobalt oxide thin films were deposited on to a chemically cleaned pyrex glass substrates. The deposition was carried out in a simple and low cost fume chamber. Fig 1 shows the schematic diagram of the deposition set up. The set up includes the precursor solution, carrier gas assembly, heater, substrate holder and temperature measurement arrangement. The film deposition is done when jets of fine aerosol of starting solution is driven by the carrier gas towards the heated substrate, where pyrolytic reaction takes place. The gas flow rate and the substance nozzle distance was adjusted in such a way that 10 to 30 minutes spray produces 1800Å to 6500Å thick uniform films. In the present work 0.1M cadmium acetate and Nickel acetate dissolved in deionized water was used as the working solution. Substrate temperature ranging from 250°C to 380°C was tried and 350°C was found to be suitable for producing good quality films. Substrate temperature was measured by using copper-constantan thermocouple and the substrate temperature fluctuates within  $\pm 5^{\circ}\text{C}$ .



The possible chemical reaction that takes place on the heated substrate may be as follows.

$$300^{\circ}\text{C}$$



A Philips PW3040 X'Pert PRO X-ray diffractometer was used to characterize the materials and to determine the lattice parameters. The monochromatic (using Ni filter) CuK $\alpha$  radiation was used whose primary beam power was 40 kV and 30 mA. All the samples were irradiated over 2 $\theta$  range from 10° to 70° to get possible fundamental peaks of the sample. The surface properties of the films were studied using HITACHI S-3400N Scanning Electron Microscope (SEM). The optical reflectance and transmittance spectra of the film with reference to glass substrate were taken for wavelength range 350nm to 1100nm using UV-1601 PC Shimadzu spectrophotometer. The thickness of the films was determined by using Fizeau fringe interferometric method. Hall effect measurements were made to evaluate the Hall co-efficient, Hall mobility, and carrier concentration at room temperature and magnetic field was kept at 9.75 Kilo-Gauss. The temperature dependent electrical resistivity in the temperature range 300K to 600K was studied by Van der Pau method. Copper- constantan thermocouple was used to determine the temperature. Indium was used as ohmic contacts. Some samples were subjected to a heat treatment consisting of heating and cooling cycle from room temperature to 600k under ambient conditions.

### 3. RESULTS AND DISCUSSIONS

#### 3.1 Determination of structure

X-ray diffraction spectra obtained for undoped and Ni-doped cobalt oxide are shown in Fig. 2. Spectrum of the as-deposited film (Fig.2a) show a broad peak around 2 $\theta$  = 23° and having a small peak near 2 $\theta$  = 37°. This indicates that as-deposited material is mainly amorphous and also contains some small crystallites. On annealing the film at 400°C in air for one hour a number of highly resolved characteristic peaks have been developed in the spectra, but the broad peak with less prominence also remain present in the spectra. The existence of broad peaks shows that some amorphosity is still left in the film material but material mostly has become polycrystalline. The characteristic peaks were identified from JCPDS chart and these are 2 $\theta$  = 18.84°, 31.22°, 36.42°, 59.1°, 65.5° having (hkl) value (111), (220), (100), (511), (440) respectively for Co<sub>3</sub>O<sub>4</sub> and 2 $\theta$  = 44.36° having (hkl) value (400) for CoO. Thus it may be assumed that the film prepared consists of two phases Co<sub>3</sub>O<sub>4</sub> and CoO but the main phase is Co<sub>3</sub>O<sub>4</sub>. The structure of the material has been identified as cubic. Lattice constant has been calculated using the dominant peaks for Co<sub>3</sub>O<sub>4</sub> and the average value obtained is,  $a \cong 4.00 \text{ \AA}$ , which is close to the standard value,  $a = 4.22 \text{ \AA}$ .

Fig.2 also shows the XRD spectra of Ni-doped films with nickel concentration of 1 and 6 percent. XRD were taken on annealed films. Spectra obtained show the crystalline nature of the films. No addition peak for Ni could be observed on the spectra even with the addition of 6% nickel. Thus it may be explained assuming that upto this concentration Ni form solid solution with cobalt oxide and that Ni occupies the position of Co in the structure and thus shows no extra peak.

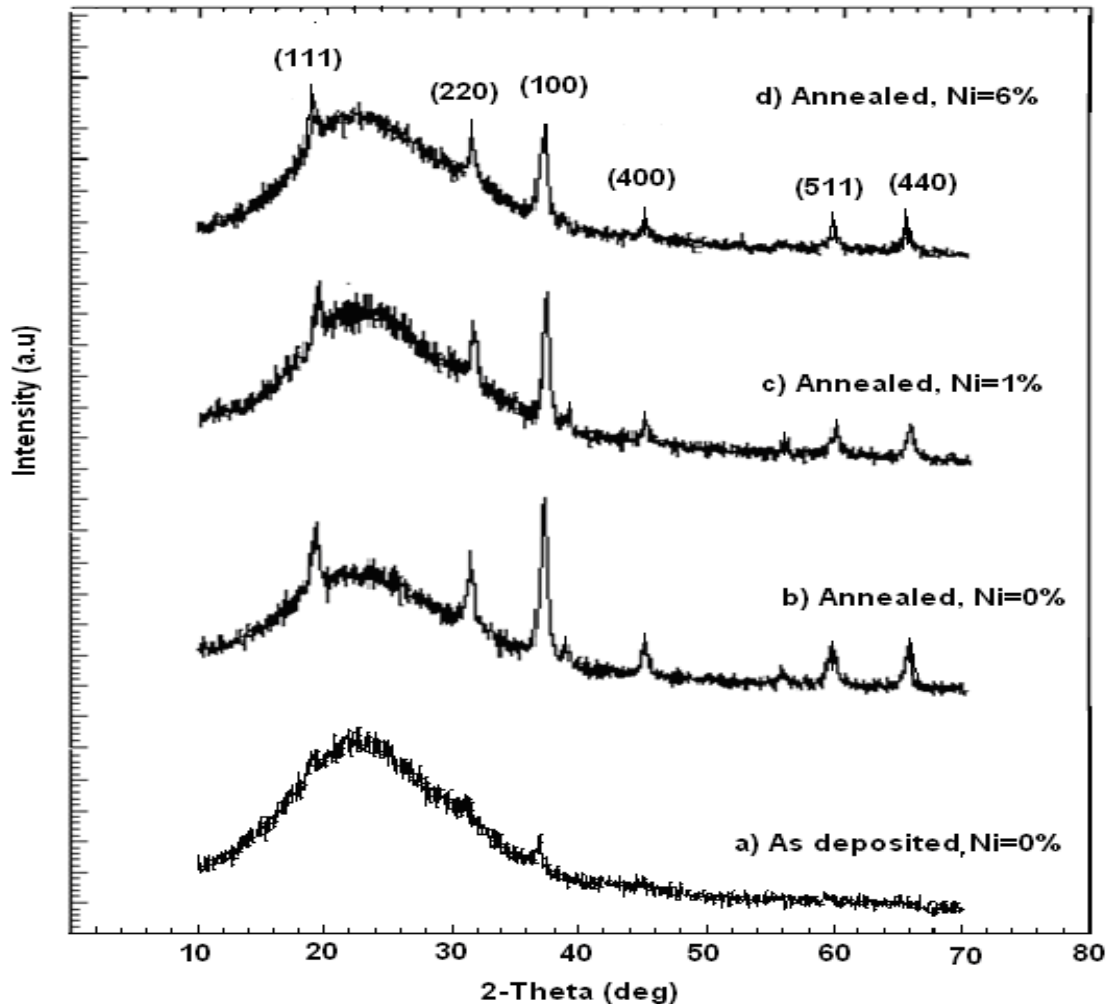


Fig. 2 XRD spectra of Ni-doped cobalt oxide thin films deposited on glass substrate.

### 3.2 Surface morphology

Surface morphology of cobalt oxide and Ni-doped cobalt oxide samples having thickness of  $\approx 130$  nm was studied by scanning electron microscopy under 500 and 5,000 magnifications. The surface of the film was found to be smooth, uniformly covered the whole substrate surface. SEM photographs under 500 magnification shows that sprayed particles have deposited on substrate as clusters having well defined nucleation centres (Fig.3a). With higher magnification clusters appears as randomly oriented nano fibres. Diameter of these fibre found to increase slightly with the increase of Ni-concentration. The approximate average diameter of these nano fibres are  $\approx 100$  nm. Similar nano fibre structure was observed on spray deposited ZnO [9].

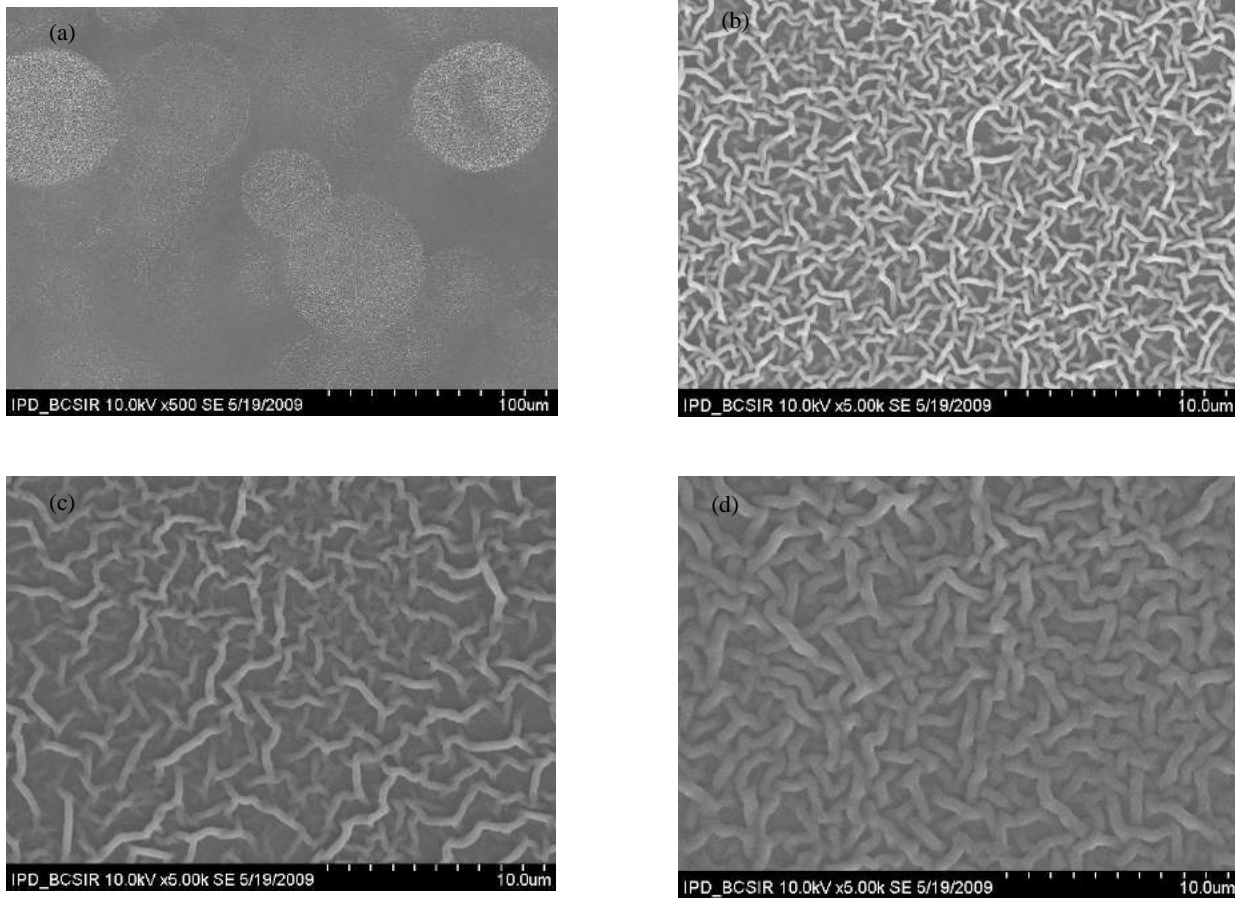


Fig. 3: SEM micrograph (a) Ni=0%, (b) Ni=0%, (c) Ni=3%, (d) Ni=5%

### 3.4 Optical Properties

The optical transmission and reflection measurements were made on Ni-doped cobalt oxide films deposited on glass substrate at substrate temperature 300<sup>o</sup>C. Spectra for films of different thickness were taken within wavelength range of 350 to 1100 nm. Reflectance (R) and transmittance (T) spectra obtained for a number of Ni-doped cobalt oxide films are shown in Fig. 4 and Fig. 5 respectively. Fig. 4 shows that reflectance first increase with the increase in wavelength the value reaches to a maximum and then slowly decreases with wavelength. But in Fig.5 transmittance initially remains same as wavelength increases and beyond 780nm the value rises sharply and then reaches to its highest value. It is most likely due to d-d transitions absorbing in the visible light. Absorption coefficient ( $\alpha$ ) has been calculated from reflectance and transmittance spectra by using the relation

$$\alpha = \frac{1}{t} \ln \left[ \frac{(1-R)^2}{T} \right] \dots\dots\dots(1)$$

Variation of absorption coefficient with photon energy has been shown in Fig. 6. The absorption coefficient first increases slowly in the low energy region and then increases sharply near the absorption edge. Finally its value tends to become saturated at high energy region (i.e. above 1.6 eV). The absorption coefficient increases with the increase in Ni-concentration.

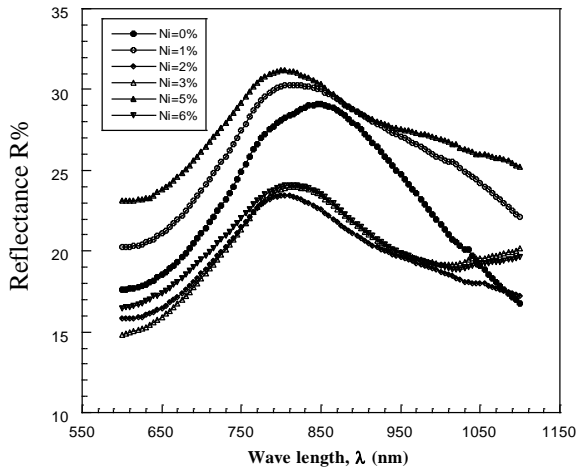


Fig. 4: Variation of reflectance with wavelength for Ni-doped cobalt oxide films.

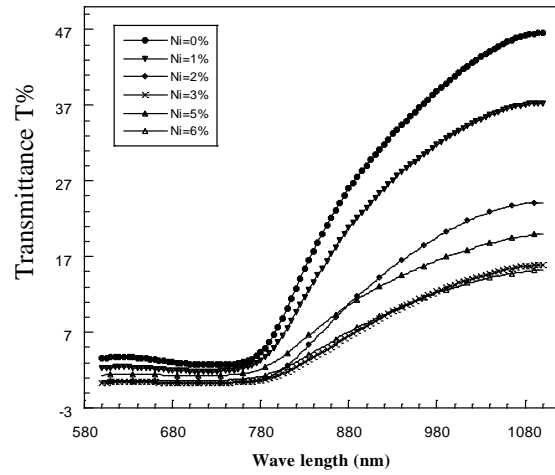


Fig. 5: Variation of transmittance with wavelength for Ni-doped cobalt oxide films.

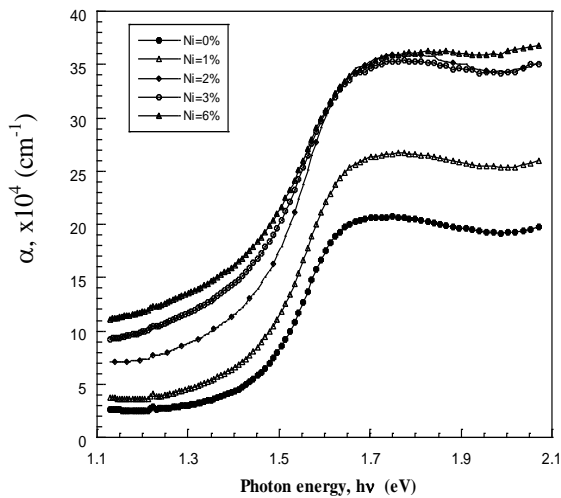


Fig.6: Variation of absorption coefficient with photon energy for Ni-doped cobalt oxide films.

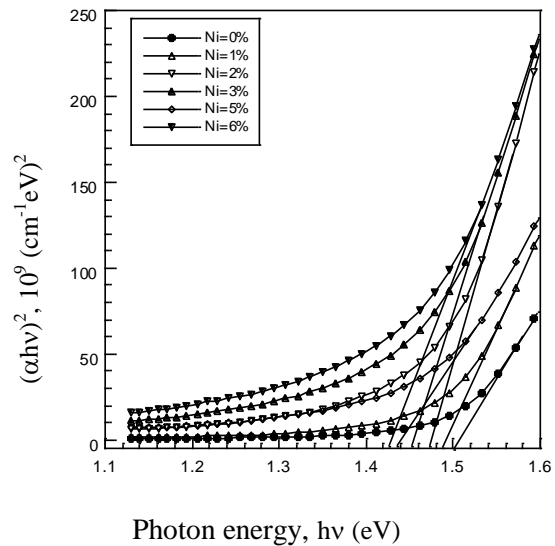


Fig. 7: Variation of  $(\alpha hv)^2$  with photon energy for Ni-doped cobalt oxide films.

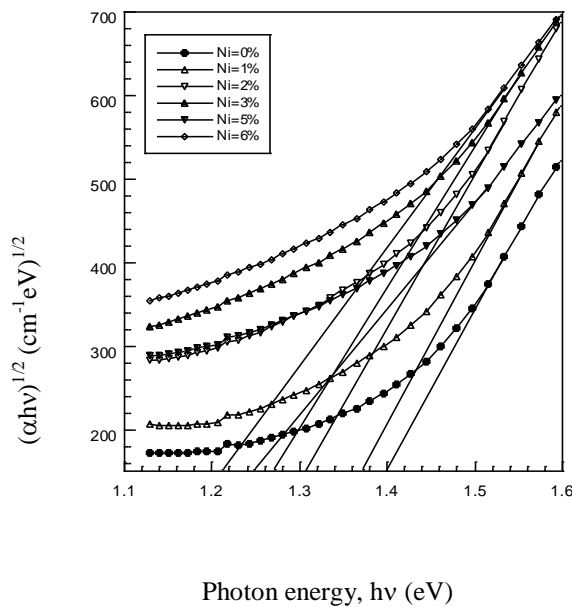


Fig. 8: Variation of  $(\alpha h\nu)^{1/2}$  with photon energy for Ni-doped cobalt oxide films.

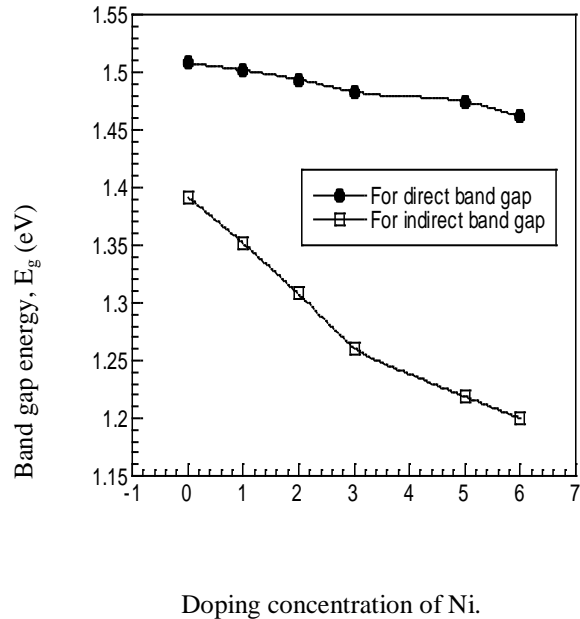


Fig.9: Variation of band gap energy with photon energy for Ni-doped cobalt oxide films.

The optical transmission and reflection data were analyzed using the classical relation for near edge of the optical absorption (for  $\alpha > 10^4 \text{ cm}^{-1}$ ) using the relation

$$(\alpha h\nu) = B(h\nu - E_g)^n \dots\dots\dots(2)$$

Where  $B$  is a constant,  $E_g$  is the optical band gap, and  $n$  is an index related to the density of state curves for the energy band.  $n$  is determined by the nature of the optical transition involved in the absorption process. ( $n=1/2$  for direct allowed transition and  $n=2$  for an indirect allowed transition). For the determination of band gap analysis of the data have been made using both  $n=1/2$  and  $n=2$ .

A plot of  $(\alpha h\nu)^2$  vs.  $h\nu$  (direct allowed transition) and  $(\alpha h\nu)^{1/2}$  vs.  $h\nu$  (indirect transition) for Ni-doped cobalt oxide films are shown in Fig.7 and Fig.8 respectively. The band gap energy was obtained from the intercept on the energy axis after extrapolation of the straight line section of  $(\alpha h\nu)^2$  vs.  $h\nu$  curve and  $(\alpha h\nu)^{1/2}$  vs.  $h\nu$  curves respectively. Optical band gap obtained for direct and indirect transitions are given in the Table 1. Depending on the Ni-concentration on the films the direct band gap varies from 1.462 eV to 1.508 eV and indirect band gap varies from 1.200 eV to 1.392 eV. Variation of band gap energy with Ni-concentration is shown in Fig. 9. The band gap decrease with Ni-concentration and this could be due to the increase of density of localize state near the valance band. From the nature of graph and the value of  $E_g$  it may be said that Ni-doped cobalt oxide is direct band gap semiconductor.



Table 1: Values of direct and indirect band gap energy for Ni-doped cobalt oxide films.

Doping concentration of Ni	Direct band gap energy in eV	Indirect band gap energy in eV
0%	1.508	1.392
1%	1.502	1.352
2%	1.494	1.308
3%	1.483	1.260
5%	1.475	1.219
6%	1.462	1.200

### 3.5 Electrical properties

#### 3.5.1 Measurement of Hall effect

Hall constant ( $R_H$ ), Hall mobility ( $\mu_H$ ), carrier concentration ( $n$ ) have been calculated from Hall effect measurements. Measurements show that Ni-doped cobalt oxide is p-type semiconductor and current carriers are holes. Variation of  $R_H$ ,  $\mu_H$  and  $n$  with Ni concentrations are shown in Fig. 10 and Fig.11. From figures it can be seen that  $R_H$  and  $\mu_H$  decrease with increasing Ni concentrations but carrier concentration increases as the Ni concentration increases. Carrier concentration obtained for Ni-doped cobalt oxide is of the order of  $10^{19} \text{ cm}^{-3}$ , the value increases with the increase in Ni concentration. The high carrier concentration of the films shows that the material is nearly metallic. Values of  $R_H$ ,  $\mu_H$  and  $n$  for different Ni concentration on the films are given in Table 2.

Table 2. Data for  $R_H$ ,  $\mu_H$ ,  $n$  and activation energy for different doping concentration of Ni.

Doping concentration of Ni (%)	Hall constant, $R_H$ $\text{cm}^3/\text{coul}$	Hall mobility, $\mu_H$ $\text{cm}^2/\text{v-sec}$	Hall concentration, $n$ $\times 10^{19} \text{ cm}^{-3}$	Activation energy $\Delta E_1$ in eV	Activation energy $\Delta E_2$ in eV
0	0.0714	73	8.75	0.207	0.432
1	0.0394	66	18.16	0.217	0.431
2	0.0057	40	267	0.216	0.308
3	0.0021	33	325	0.109	0.258
5					0.174
6					0.173

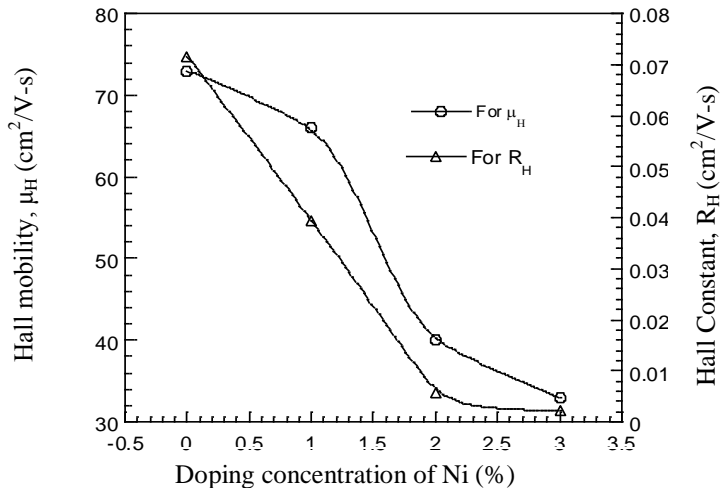


Fig. 10: Variation of  $\mu_H$  and  $R_H$  with Ni-concentration

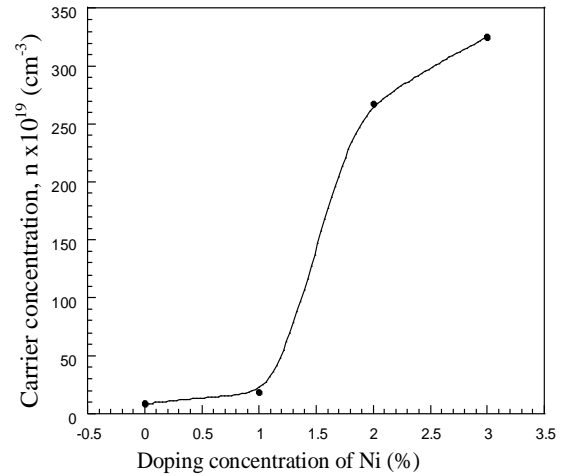


Fig. 11: Variation of carrier concentration with Ni-concentration

### 3.5.2 Variation of resistivity with temperature

Resistivity measurements were made in air on as deposited films from room temperature to 450 K. On increasing temperature upto 450 K, the films were kept at that temperature for one hour i.e the film was annealed 450 K temperature for one hour. Resistivity was then measured decreasing slowly to room temperature. Samples were then again heated slowly and resistivity was measured. Variation of resistivity with temperature during heating and cooling is shown in Fig. 12. It is clear from figure that resistivity shows a non-reversible behavior between first heating and cooling cycles. However, resistivity shows reversibility on annealing and eventually retraces the same paths indicating a stable state of the material. The attainment of stability of the film may be due to the removal of metastable phases, inhomogeneity, stress and defects that usually remain present in a freshly prepared sample. It is also clear that the resistivity of stable films is lower than the resistivity of the as-deposited films. This lowering of resistivity could take place if one consider that on annealing some conduction paths have been created due to the removed of some defects that usually remain on an as-deposited films. At room temperature the resistivity of undoped cobalt oxide is of the order of  $10^{-2}$  ohm-cm which is close to the value reported by Charles F. Windisch [10]. Fig.13 shows variation of room temperature resistivity of cobalt oxide with different Ni-concentration. Initially resistivity decreases quite sharply with small concentration of Ni and almost become constant value above 3% Ni-concentration in the sample.

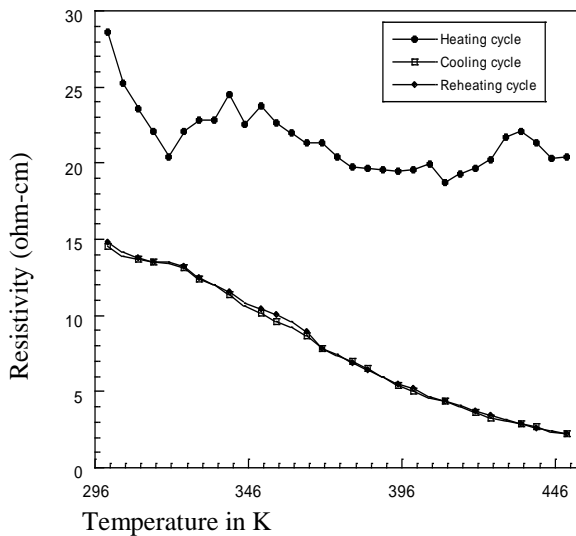


Fig. 12: Variation of resistivity with temperature for cobalt oxide film.

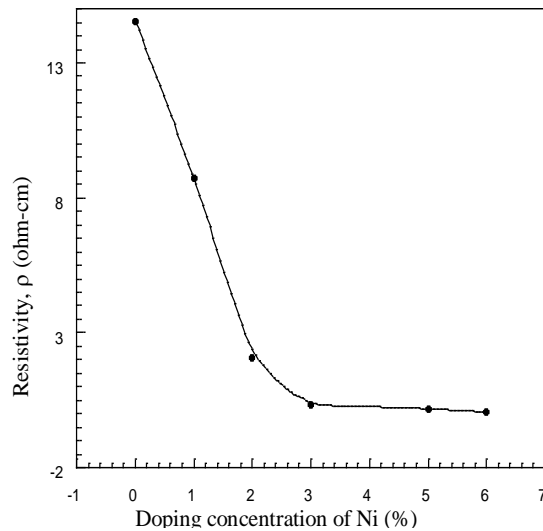


Fig.12: Variation of resistivity with Ni-doping

### 3.5.3 Variation of conductivity with inverse temperature and estimation of activation energy

Fig. 14. Figure shows the plot of  $\ln\sigma$  vs.  $1/T$  for a number of films with different Ni concentration. Curves shows a non-linear variation of conductivity with temperature which indicates that more than one kind of conduction mechanisms are involved in this material within the temperature region we have measured. In the low temperature region variation of conductivity is almost linear and in the high temperature region it is nearly exponential. The conductivity also increases with the increase of Ni concentration in the film. In both the temperature regions the d.c. electrical conductivity may be expressed by the usual relation

$$\sigma = \sigma_0 \exp\left(-\frac{\Delta E}{2kT}\right) \dots\dots\dots(3)$$

where  $\sigma_0$  is the pre-exponential factor,  $\Delta E$  is the activation energy and  $k$  is the Boltzman constant.  $\Delta E$  for the two temperature regions have been calculated using the above relation and the value obtained for the two regions,  $\Delta E_1$  for low temperature region and  $\Delta E_2$  for high temperature region, were calculated from the slope of the plots. The obtained values are given in Table-2. Low values of activation energies  $\Delta E_1$  and  $\Delta E_2$  indicate that the conductivities are associated with the intraband transition of carriers. The electrical properties of cobalt oxide and Ni-doped cobalt oxide may well be explained using defect model.

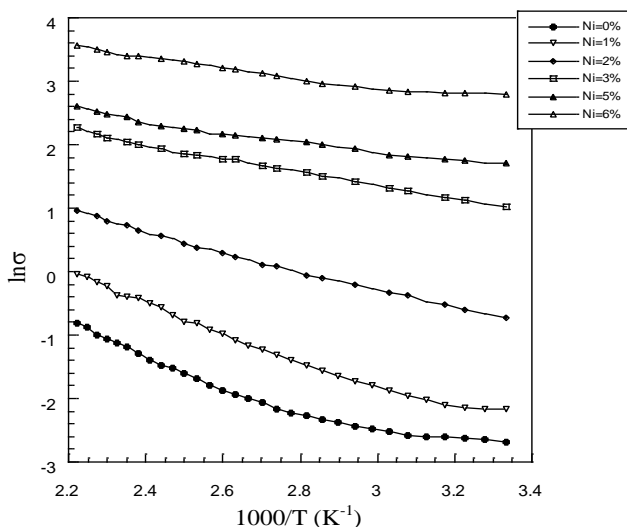


Fig.13: Variation of  $\ln\sigma$  with  $1/T$  for different Ni concentration

#### 4. Conclusions

In the present work, cobalt oxide and Ni-doped cobalt oxide thin films were prepared by spray pyrolysis method. Films of different thickness and different Ni concentration were deposited on glass substrate keeping the substrate temperature at 300<sup>0</sup>C. Different physical properties such as structural, optical and electrical properties have been studied. It has been observed that the deposition of cobalt oxide films depends on various parameters such as substrate temperature, concentration of the solution used, spray rate and deposition time. Film deposited at 300<sup>0</sup>C substrate temperature is found to be good in terms of their uniformity of thickness and color. X-ray diffraction, SEM studies were made to identify the quality and structure of the deposited films. XRD results show that as deposited film is mostly amorphous with small crystallinity. But on annealing material become polycrystalline with the appearance a number of characteristic cobalt oxide peaks. Peaks have been identified and it is concluded that the structure is cubic with lattice constant  $a \cong 4.00\text{\AA}$ . This value is quite close to the reported value. SEM study show that films are smooth and uniform and nanostructure appear around the nucleation center. Absorption coefficient and band gap of energy cobalt oxide and Ni-doped cobalt oxide have been evaluated. The absorption coefficient was found to be of the order of  $10^4 \text{ cm}^{-1}$  near the absorption edge and band gap is of the order of  $\approx 1.449 \text{ eV}$ . The band gap energy slightly varies with film thickness and also on Ni concentration. From Hall effect measurements it is found that cobalt oxide is a p-type material having carrier concentration is of the order  $10^{19} \text{ cm}^{-3}$ , and hole

is the prime carrier. It is found that  $R_H$  and  $\mu_H$  decreases but carrier concentration increases with the increase in Ni-concentration. Electrical resistivity measurements from room temperature to 450K it is found that the resistivity is of the order of  $10^{-2}$  ohm-cm at room temperature. Resistivity decreases with the increasing Ni concentration. Conductivity shows two types of activation process within the measured temperature range. In the high temperature region activation energy varies from 0.173 eV to 0.432 eV and in low temperature region activation energy varies from 0.109 eV to 0.207 eV depending on Ni concentration and the conduction may be due to hopping. Results obtained from optical, electrical and structural measurements are found to be in good agreement with the results obtained on this material prepared by other methods.

## REFERENCES

- [1] Grave, W. R. Phil. Trans.Royal.Soc.,London, 147 (1851) 345.
- [2] Bunsen, R. J.,Prakt.Chem., 56 (1852) 53.
- [3] Nahrwold,R. Ann,Physik, 31(1887)467.
- [4] Kundt. A.,Ann Physik,31 (1888) 473.
- [5] Thomson, J.J.,Proc.Cambridge Phil.Soc., 11 (1901) 120.
- [6] Fuchs, K. Proc. Cambridge Phil. Soc., 34(1938) 100.
- [7] Sondheimer, F. H. Phys. Re., 80 (1950) 401.
- [8] Compbell, D. S. ,The use of thin film in physical investigation, New York, Academic press, (1966).
- [9] Mayadas and Shatzkes, matter, Res. Bull (1970)
- [10] J.H.Thomson III, USA, Thin Solid Films, Vol-44, No-2, (1977)155- 161.
- [11] G.McDonald, Thin Solid Films, 72(1980) 83-87.
- [12] R.Carey and B.W.J. Thomson, D.M. Newman, Thin Solid Films, Vol.- 66, No-2(1980)139-149.
- [13] R.Carey and B.W.J. Thomson, D.M. Newman, Thin Solid Films, Vol-67,No-1, (1980) P.L 35-L-40.
- [14] Toshiro Maruyama and Tsuyosihi Nakai, Solar energy materials, 23 (1991)25-29.
- [15] A.J.Varkey and A.F. Fart, Solar energy Materials and Solar cells, 31(1993)277-282.
- [16] Susma Pelhkar, M.G. Takawale, Chitra Agshe and V.G. Bhide, Vol-3, No-2,(1993)109-117.
- [17] C.N. Poloda Fonseca, Marco-A De paoli, A Gorenstein, Solar Energy Matter, Solar Cells 33(1994) 73.
- [18] P.S. Patil, L.D. Kadam, C.D. Lokhnade, Thin film Solid Films 272(1996) 29.

- [19] P.S. patil, L.D. Kadam, C.D. Lokhnade, Solar Energy Materials and Solar Cells 53(1998) 229-234.
- [20] Charles F.Windisch, Jr., Kim F. Ferries, and Gregory J. Exarhos, Journal of vacuum, Surfaces, and Films, 19(2001)1647-1651
- [21] Hidero Unuma, Youichi Saito, Kunio Watanabe and Sugawara, Thin solid films, 468(2004)4-7
- [22] K.L. Chopra and S.r. Das, Thin Film Solar Cells, Plenum Press New York and London-1969
- [23] L.I.Maissel, Hand Book Of Thin Film Technology, Mc. GrowHill Book Co. New York-1970.
- [24] A.Growswami, R. Glang, Thin Film Fundamentals, New International (P) Limited. New Delhi, India-1996.
- [25] D.W. Pashely, Adv. Phys. 14(1965) 16.
- [26] Vander Paw, Philips Techn. Rdch. 20(1958) 230.
- [27] Robert W. Berry and Peler M. Hall Merry, T. Haris, Thin Film TechnoloOgy, D. Vaqn Nostrand Co. Inc., 329(1968).
- [28] N. F. Moh and E. A. Devis, Electronic process in Noncrystalline Materials Clarandon, Oxford, 1979
- [29] A Goswami, Thin Solid Film Fundamental, New age international publishers, New Delhi, India (1996)
- [30] C. K. Carniglia, Basic Concepts of Coating Design, Martin Maariaetla, Aerospace
- [31] O. Z. Murman, Phys. 80(1933); 101(1936)643
- [32] Blodgett K et al, Phys. Rev. 51(1937) 964
- [33] Wiener, O. Wied Ann 31(1887) 629
- [34] Gottling, J. G. et al. Opt. Soc. Am. 56(1966)227
- [35] Grove, W.R. Phil. Trans, Roy. Soc. London, 142(1852) 87
- [36] Bunsen, R.J. Prakt. Chem, 56(1887)53
- [37] J. Barden, F.J. Blatt, and E.H. Hall, (1965). Photoconductivity confer, Eds. R. Wreckarridge, B. Russel and Halmn, B. Russel and Halmn, New York.
- (J.Newtons and M. Rekas J. Am. Ceram. Soc. 72, 1207,1989)

## Investigation of long term evapotranspiration factor by using Hamon equation and NDVI data in forest area

<sup>1</sup>Edwina Zainal, <sup>2</sup>Kojima Toshiharu

<sup>1</sup> M. Eng., Graduate of School of Civil Engineering, Gifu University  
(1-1 Yanagido, Gifu City 501-1193, Japan), edwina25@green.gifu-u.ac.jp, +81-58-293-2070  
<sup>2</sup> Dr. of Eng., Associate Professor, River Basin Research Center, Gifu University  
(1-1 Yanagido, Gifu City 501-1193, Japan), kojima@green.gifu-u.ac.jp, +81-58-293-2070

### Abstract.

This study investigated ways to identify appropriate long term evapotranspiration factor ( $f_{ep}$ ) based on their monthly and annually performances in the small forest watershed of Nakatsugawa City, Japan. Evapotranspiration factor ( $f_{ep}$ ) is estimated by ratio of the actual evapotranspiration ( $e_t$ ) over the potential evapotranspiration ( $e_p$ ). The  $e_t$  is describing the total loss of water where calculated from an indirect estimation using the water balance of a watershed, where assumed the soil water storage changes is negligible. The  $e_p$  values have estimated by the Hamon equation at monthly and annually temporal scale. Performance analysis estimated values using the hydrological data and meteorological data for 24 years (1984-2007) were made. In the other hand, Normalized Difference of Vegetation Index (NDVI) data derived from remote sensing were used to assess the historic of leaf area change patterns. The result of revealed a positive relationship between evapotranspiration factor and NDVI ( $f_{ep}=1.3975NDVI + 0.4875$ ,  $r^2=0.30$ ). It could provide an effective predictive tool for determining evapotranspiration rates in forest area that lacking weather data, and it might also contribute as a function of water conservation forest.

**Keywords:** forest potential evapotranspiration, long term forest monitoring, remote sensing, Hamon method, water balance, Automated Meteorological Data Acquisition System (AMeDAS)

### 1 Introduction

Forest management and conservation are promoted according to the "Forest and Forestry Basic Plan" based on the "Forest and Forestry Basic Law" as well as the "National Forest Plan", "Prefectural Forest Plans," and "Municipality Forest Plans" based on the "Forest Law" to improving multiple functional roles [13]. The watershed protection function of forests is also referred to as the green dam, has been widely recognized as one of the most important forest function. Watershed function is classified into a flooding mitigation function for reducing the peak discharge during floods, water resources reservoir function for maintaining the river flow when no rain or drought mitigation functions. These features are overall results of the various hydrological processes, soil layer thickness, permeability, the various elements of the crown sparse, etc. As a matter of fact, to evaluate the watershed function of each forest is a difficult problem. Consequently, a better understanding of hydrological processes for forest management area is also needed for evaluation of watershed function.

Evapotranspiration from forest is one of the major hydrological components influencing the water cycle. It is can define as the total amount of water that is returned to the atmosphere from the surface of the soil, water bodies and vegetation by the influence of climatic factors and physiological vegetation. Zhang et al. [27] discovered the long term impact of vegetation changes on mean annual evapotranspiration at catchment scales by reviewing and collating over 250 catchments from around the world. They suggest that long term average annual evapotranspiration under the same climatic conditions is mainly determined by vegetation characteristic, and the difference may be attributed to the way different kinds of vegetation use soil water. Moreover, Komatsu et al. [9] examined the change of water yield because of forest management such as thinning of coniferous plantation and obtained the evapotranspiration from the catchment water balance measurement.

In spite of the fact that evapotranspiration processes are complex and difficult to measure, the estimation may be represented by indirect procedures through correlation with meteorological factors and is called potential evapotranspiration (PET) that has been proposed. Alkaeed et al. [1] compared

the Thornthwaite, Hargreaves, Hamon, and the  $R_s$ - and  $R_n$ - methods with FAO56-PM on their daily performances under the given climatic condition in the western region of Fukuoka City. When considering the availability and reliability of the input data, the use of these methods are suggested as practical methods for estimating evapotranspiration, if the standard FAO56-PM equation can't be used due to the complexity of its input parameters. In recent studies, Priestley-Taylor PET method gave the most reasonable estimates of forest PET compared with FAO56 grass reference and Hamon PET [16]. For the reason that the net radiation data are generally unavailable in Japan, Priestley-Taylor PET method is not helpful for the evapotranspiration estimate. However, the conclusion mentioned that Hamon method was easy to use in the event that accompanied by correction factor, especially for regions lacking detailed meteorological data. Xystrakis et al. [25] also suggested that the Hamon equation perform considerably well.

Some procedures use to predict evapotranspiration involve some type of PET and the combination method to derive the actual evapotranspiration. For the reason that the Hamon PET can't be used for directly estimating forest PET, then a correction factor proposed by Tsukamoto [22] involving Japan's forest area was introduced. It is a simple enough to provide the correction factor and is called as an evapotranspiration factor.

$$e_t = f_{ep} \times e_p \quad (1)$$

where:  $e_t$  is actual evapotranspiration,  $f_{ep}$  is evapotranspiration factor and  $e_p$  is PET. In this study, the Hamon PET is considering for estimation  $e_p$  and the water balance method is considering as  $e_t$ . On the occasion of determination of actual evapotranspiration from catchment water balance must following some criteria, which assume negligible change in catchment water storage and using long term data [2][23]. The concept requires closer specification if it is to serve as an unequivocal parameter and need validation of PET method for over longer period. Shimizu et al. [20] and Kosugi et al. [11] validated forest water use using the eddy covariance method agreed well with the water balance losses in some Japan forest area. In addition, the heat fluxes of eddy-covariance measurements over a forest on steep slopes in region with cool temperate evergreen coniferous forest that experiences snowfall have a similar accuracy as those over other topography [18]. In order to assess the validity of the method, we compared eddy covariance evapotranspiration adjusted using the energy budget for 3 years over a nearby study site and used the "reference of evapotranspiration factor" by Tsukamoto [22] as the standard way to represent the correction factor of forest PET, thus make factor of evapotranspiration PET estimates comparable.

The direct methods such as satellite-based vegetation index, NDVI methods, to estimate evapotranspiration that has been convert potential evapotranspiration into actual evapotranspiration [19]. Kondoh [10] demonstrated that the evapotranspiration was well correlated with NDVI. A simple linear regression model is developed to establish a general relationship between a normalized difference vegetation index (NDVI) from satellite data and the crop coefficient that calculated based on estimation of crop evapotranspiration [6] [7]. Using the same logic, the similarities between forest evapotranspiration factor and NDVI showed potential for modeling a factor evapotranspiration as a function of the vegetation index.

The objectives of the study were to: (1) develop ways for estimate forest evapotranspiration factor by ratio of actual ET derived from catchment water balances over the Hamon PET across a range of the long term availability data, (2) analyze the amplitude of seasonal fluctuations of evapotranspiration factor over the long term and (3) to establish the relationship between the evapotranspiration factor and NDVI that can be modeled reasonably to provide an effective predictive tool for determining evapotranspiration rates in forest area that lacking weather data. In this study, we also attempt to develop a method to assess the watershed function easily by using the hydrological observation data and satellite data in small forest watersheds that have long-term observation of the runoff data.

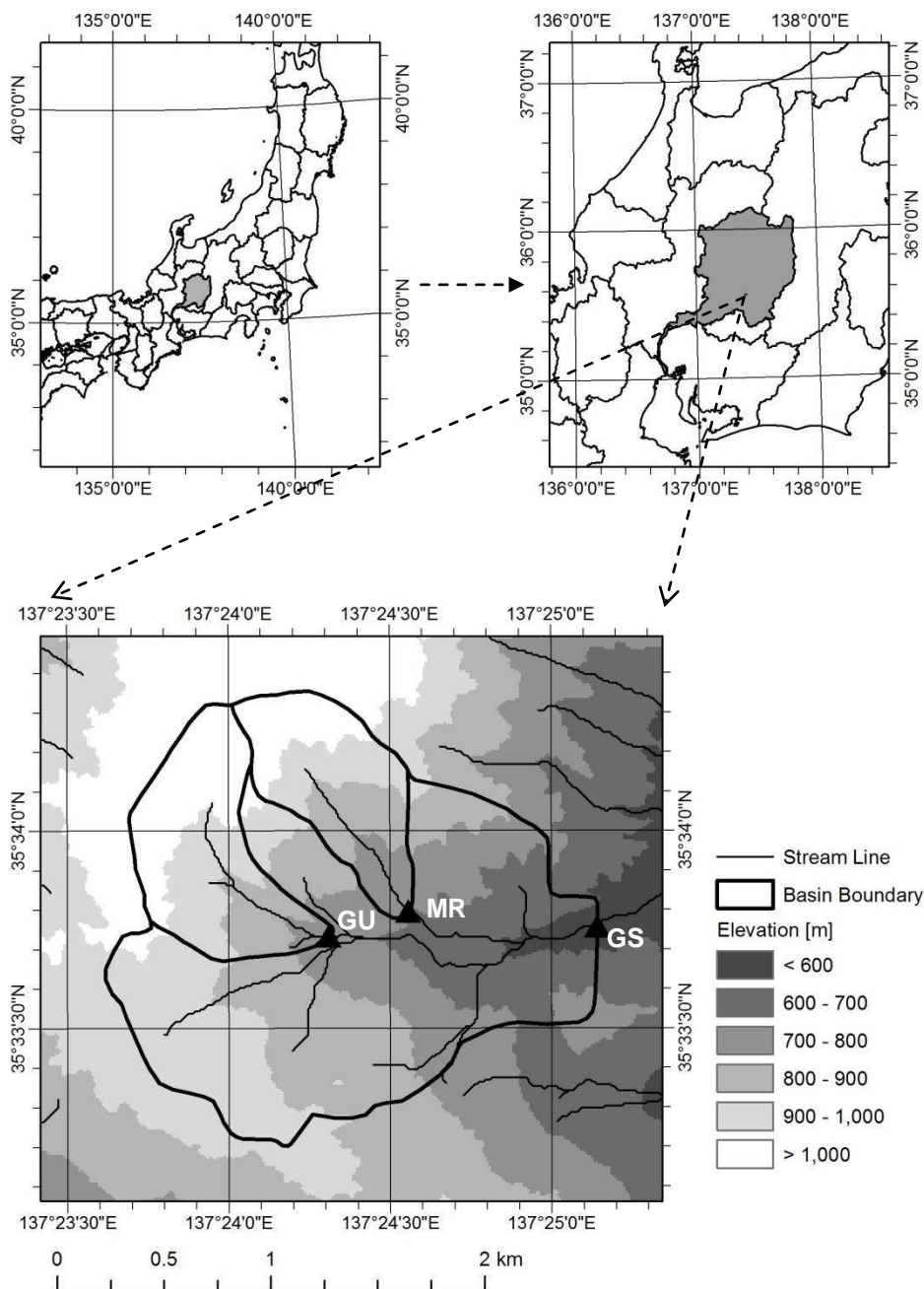
## 2 Study Site

The study site was made in Futatsumori experimental watershed, Fukuoka district of Nakatsugawa, southeast of Gifu Prefecture, which belongs to the Kiso River sytem Japan at 35°33'N, 137°24'E with elevation range from 440 to 1223 m (Fig-1). The main catchment is the Gaman Stream lower catchment (GS, 3.2km<sup>2</sup>) and sub-catchments are the Gaman Stream upper catchment (GU, 0.6km<sup>2</sup>),



the Morigahora intermediate catchment (MR, 0.5km<sup>2</sup>), respectively, where the gauging weir is installed. Tree species composition over the area dominated by cypress 67.0%, red pine 4.5%, cedar 4.3%, needle leaf forest 19.9% hardwood and broadleaf forest 4.3%. The mean annual precipitation is 2284.7 mm and the main temperature is 11.8°C. The temperature analysis of study site has shown the weak trend (+0.00540°C/year) of changing rates of temperature over the last 24 years, details shown in climate trend of Futatsumori [26].

This watershed as target region is included water and soil conservation enhancements comprehensive model project in the simultaneously 5 years period from 1983 fiscal year that carried by Gifu Prefecture Forestry Agency to achieve the effective use of water and soil conservation features and forest resources, such as construction of multi-layer forest, installation of infiltration facilities, infrastructure maintenance, installation of hydrological observation facilities, etc. [17]. Moreover, forest management such as silvicultural thinning has been implemented from 1986 to 1988 in the study site. In addition, this region is upstream of Chukyo area (Nagoya and environs), many other dams have been installed and is using as an important water resource since a long time ago.



**Figure 1** Location study area at Futatsumori, Nakatsugawa City of Gifu Prefecture, and Japan

### 3 Methods

#### 3.1 Hamon PET

Among various PET, Hamon expression is a method to calculate a simple monthly average potential evapotranspiration by using the mean monthly temperature and daylight hours which depends on latitude. It does not require fine weather observation, so it is possible to easily calculate the potential evapotranspiration in all parts of the country. In Japan, the temperature and daylight sunshine as the input parameter available from Automated Meteorological Data Acquisition System (AMeDAS). Hamon [3] developed a simplified expression for potential evapotranspiration, represented by

$$e_p = 0.14D_0^2P_t \quad (2)$$

where,  $e_p$  is the potential evapotranspiration in mm/day;  $D_0$ , the possible hours of daily sunshine in units of 12 hours;  $P_t$ , the saturated water vapor concentration at the mean temperature in  $g/m^3$ . The  $P_t$  variable is expressed as

$$P_t = 216.7 (e_s/T + 273.3) \quad (3)$$

where,  $e_s$  is the saturated vapor pressure in hPa over water at temperature ( $T$ ) in °C was given by Tetens [21] as

$$e_s = 6.1078 \times 10^{17.277/(T+273.3)} \quad (4)$$

The equation to estimate PET adheres to desirable features of requiring available meteorological data expressed in easily computable fashion. Saturated water vapor concentration at the mean temperature adjusted by a day length factor to account for plant response, duration of turbulence, and net radiation apparently is proportional to PET. General applicability seems justified in view of the correspondence between observed and computed values of PET, both on a yearly and monthly basis for widely scattered localities.

#### 3.2 $E_t$ Estimation

Over a land surface area, the actual evapotranspiration rate over a period of years can be expressed in terms of the water balance equation, which for the study purpose can be written as follows [2][23]:

$$e_t = P - Q \quad (5)$$

where,  $P$  is the precipitation in mm;  $Q$ , the streamflow in mm;  $e_t$ , actual ET. Here, it must be applied over sufficiently long periods data, so that water storage become less important. The water storage in the basin is not easily determined, an annual period is usually considered long enough to make water storage negligible.

The long-term hydrological data (precipitation and runoff observation data) for the period of 1985 to 2007 has been measured in each catchment, but fewer data have not been recorded on 1995, 1996 and 1997 caused by instrument trouble. Monthly and annual  $e_t$  was calculated for the years 1985 to 2007 as well as PET.

### 3.3 Validation

#### 3.3.1 Monthly evapotranspiration factor

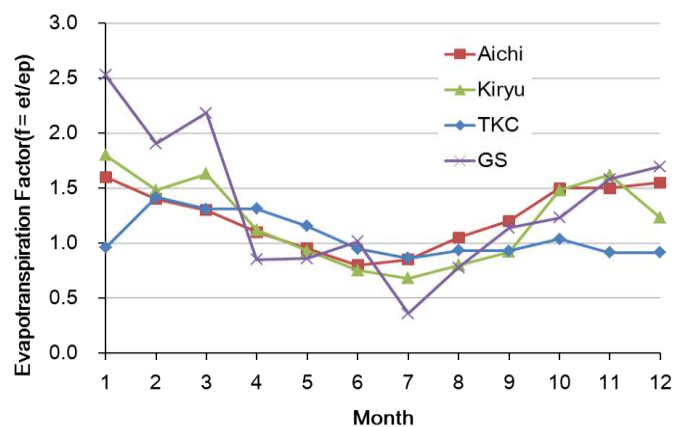
The evapotranspiration factor in the PET models are an empirical that has been derived for many land surfaces for estimating either PET or AET. Zhou et al. [28] and Lu et al. [12] indicated difference evapotranspiration factor for forest Hamon PET in differ site. However, it was unclear if this parameter appropriate for forest. Thus, the comparison of monthly evapotranspiration factor on each catchment forest site has been shown on tabel 1 and fig-2 to assess the validity of both methods, to

evaluate the amplitude of seasonal fluctuations of evapotranspiration factor over the long term and to provide a more accurate PET estimate.

**Table 1** Monthly evapotranspiration factor for Hamon forest PET

Month	Aichi	Kiryu	TKC	GS
1	1.60	1.80	0.96	2.53
2	1.40	1.48	1.42	1.90
3	1.30	1.63	1.31	2.18
4	1.10	1.12	1.31	0.85
5	0.95	0.93	1.15	0.86
6	0.80	0.75	0.95	1.01
7	0.85	0.68	0.86	0.36
8	1.05	0.80	0.93	0.78
9	1.20	0.92	0.93	1.14
10	1.50	1.48	1.03	1.23
11	1.50	1.62	0.91	1.58
12	1.55	1.23	0.91	1.70

The analysis results from short-term water balance method at Kiryu site in Shiga Prefecture and Higashiyama site in Aichi Prefecture have been reported for the seasonal fluctuations of the evapotranspiration factor [22]. Saitoh et.al [18] evaluated energy balance closure in the by eddy covariance method was carried out at Takayama site (TKC site, 36°08'N, 137°22'E; 800m a.s.l.). The  $e_t$  in TKC site was obtained using three years of continuous data (2006 to 2008). The average monthly evapotranspiration factor over 3 years on TKC site and over 23 years on GS study site for Hamon PET was calculated according to the equation (1)



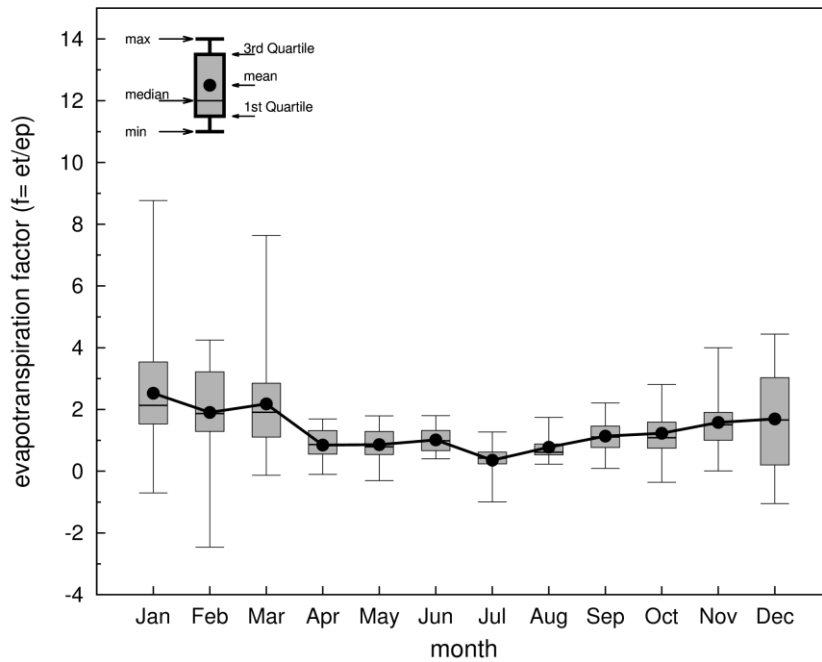
**Figure 2** Monthly evapotranspiration factor

base on evapotranspiration eddy covariance and water balance measurement, respectively. The  $f_{ep}$  estimated value of January and December on the TKC site were lower than other site. It may contain a slight error in the winter season; therefore the value has been underestimated. In the other hand, the  $f_{ep}$  of GS site seems over estimated, thus  $f_{ep}$  for winter appears to be a poor correction factor for Hamon PET. In general, winter PET show no systematic underestimation but fail to reproduce the spatial variability of PET [15]. In spite of that, the variations of monthly evapotranspiration factor both site are well corresponded for other season. It suggest that possible to obtain the evapotranspiration factor for each method in growing season. Thus, the  $f_{ep}$  of GS was confirmed and validated to provide a good alternative for estimate the evapotranspiration rate when only daylight sunshine and temperature data are available.

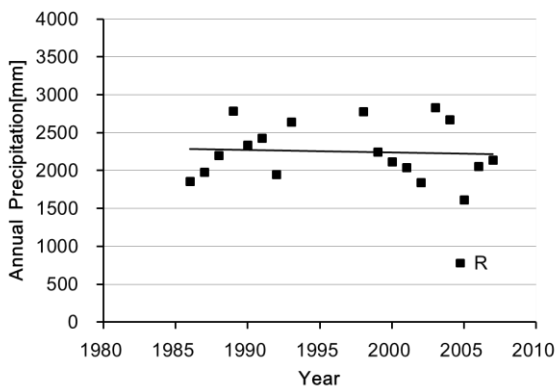
### 3.3.2 Fluctuations of GS Monthly evapotranspiration factor

The monthly average and range of evapotranspiration factor for Hamon forest PET at GS site are shown in fig-3. The range of fluctuation in the monthly evapotranspiration factor was large in the winter season (December to March), average over 23 years indicate that the standard error of the mean (SEM) were 0.84; 1.7; 0.9; and 2.6, respectively. It probably due to  $e_p$  estimation value are lowest so might implicated to water balance estimation. During the winter there is little available sunshine time, less temperature, less leaf and little plant growth. Moreover, the winter precipitations occur as snow or rain that contributed to fluctuations of monthly water balance. Snowfall has a large

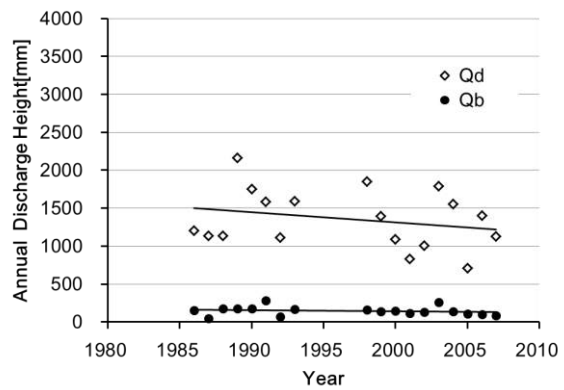
impact on hydrologic fluxes because snowfall is normally stored for a significant period of time in the snowpack and is later released as melt water. Changes to land the use, change in elevation and vegetation through the basin result have profound changes on the snow cover and on magnitude of seasonal sublimation [14].



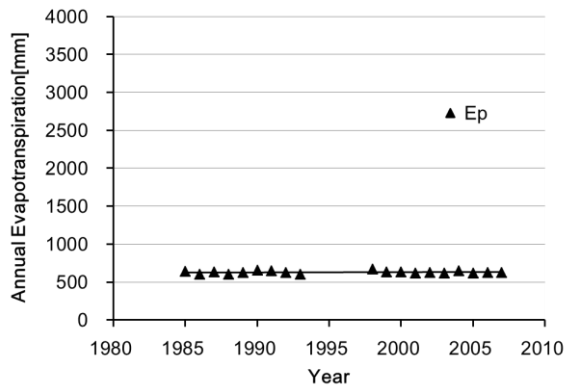
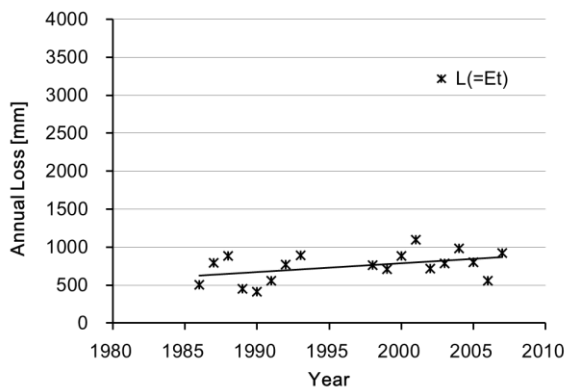
**Figure 3** The monthly average and range of evapotranspiration factor over study periods



**4(a)** Precipitation



**4(b)** Discharge



4(c) Annual Loss (=Actual Evapotranspiration)

4(d) Annual Potential Evapotranspiration

**Figure 4** Long-term annual water balance

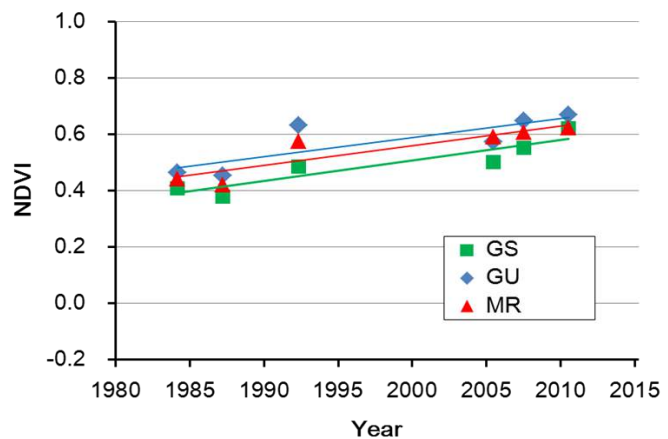
## 4 Analysis of Long Term Variability

### 4.1 Water Budget

The linear trend analysis was used to analyze long term variations of the annual water balance in GS that shown in fig-4. Annual precipitation and runoff are summarized from observation daily rainfall and discharge data. By subtracting observed annual runoff from annual precipitation (Eq.5), annual loss that assumed as actual evapotranspiration is obtained which values of all variables fluctuate over 23 years. Direct runoff is separated from the baseflow by hydrograph separation [4]. The extraction of linear trend of the water balance components: rainfall has a slightly changed trend,  $R = -3.143(\text{year}) + 8528$ ; direct flow has a significant decreasing trend,  $Q_d = -13.211(\text{year}) + 27735$ ; baseflow trend has a slightly changed trend,  $Q_b = -1.454(\text{year}) + 3048$ ; loss (=actual ev) has a strong increasing trend,  $e = 11.52(\text{year}) - 22225$ ; and trend of potential evapotranspiration,  $ep = 0.267(\text{year}) + 97$ . These means rainfall and baseflow tends to small change by -72 mm and -33 mm, respectively; directflow decrease by -304 mm; loss (actual ev) increase by 265 mm over 23 years period. Furthermore, the order of potential evapotranspiration from Hamon expression and annual loss almost same. This result founded that the Hamon PET without correction factor has been underestimate actual evapotranspiration [16][24]. In the previous study [26], climate factor shown weak trend in temperature, therefore the climate variability cannot explain in the increase in actual evapotranspiration. The interpretation is forest growth expected causes the increase in evapotranspiration as well decrease in direct runoff.

### 4.2 NDVI Trend

Kojima et al. [8] has been analyzed the long term Normalized Difference Vegetation Index (NDVI) in the study area by using the satellite image, which consisting of the Landsat/MSS, Landsat/TM and Terra/ASTER image. It was analyzed for 1984 to 2010 with atmospheric correction using 6S code (Second Simulation of the Satellite Signal in the Solar Spectrum). The observation of the vegetation has been carried out traditionally through NDVI, which is calculated using the radiometric information obtained for the red (R) and near-infrared (NIR) wavelengths of the electromagnetic spectrum ( $NDVI = ((NIR) - R)/((NIR) + R)$ ); that respond to changes in the amount of green biomass [5].



**Figure 5.** Long term variatons of NDVI

The long term of NDVI trend analysis performed on the fig-5 that positive and significant values indicate an increase in the vegetation biomass, which occurred during the study period in the GS, GU, and MR forest catchment. The significant correlation coefficients ( $r$ ) were 0.92, 0.82 and 0.9 in each catchment, respectively. It was confirmed that forest growth due to the forest management activities over the study area.

### 4.3 Correlation of Potential Evapotranspiration Factor and Normalized Difference Vegetation Index (NDVI)

The evapotranspiration factor is used to adjust the Hamon PET to account for influence of the forest growth on the evapotranspiration process. Fig-6 shows the trends of NDVI and evapotranspiration factor variables look similar. This means that both tree evapotranspiration and light absorption increase

roughly at the same rate in long term annual estimation. The relationship between long term NDVI data and observed evapotranspiration factor for forest study area on fig-7 was found linear, with the correlation coefficient ( $r$ ) is 0.55 and the proportion of variability ( $r^2$ ) is 0.30 between them. The develop correlation equations are given below

$$f_{et} = 1.40 NDVI + 0.488 \quad (6)$$

The simple equation (6) may help to monitor evapotranspiration rate in the growing season by using NDVI time series data and combining with Hamon PET estimation. Furthermore, developing relationship of evapotranspiration factor and NDVI could enhance the accuracy in estimating evapotranspiration factor values.

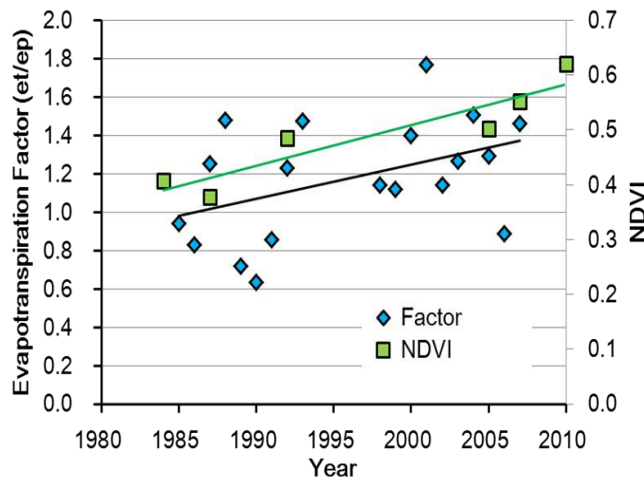


Figure 6. Long term variations of ( $et/ep$ ) and NDVI (GS)

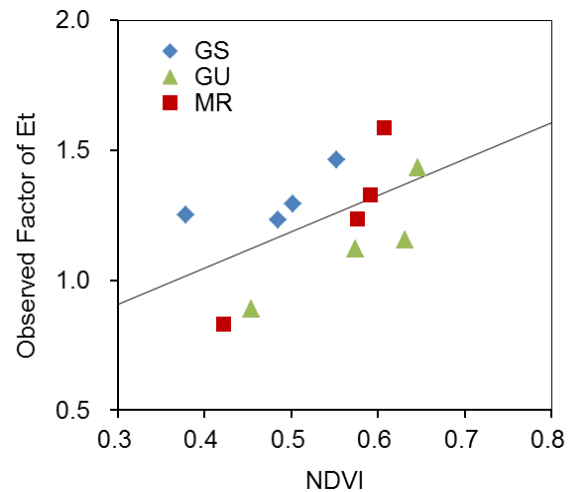


Figure 7. Relationship of  $f_{ep}$  and NDVI

## 5 Conclusion

Long term annual PET estimated from the Hamon methods were correlated with the AET values derived from the water balances. This study produce a comparable the monthly evapotranspiration factor for Hamon PET during the growing season. For the winter season, because snowfall accumulation and subsequent melting can have such a large fluctuation and influence in hydrologic response of a watershed, it is important to accurately simulate the winter processes for future research. The advantage of applying evapotranspiration factor estimates to natural watersheds the use of real time, site-specific weather data for the reference ET computation, which are much more available than are pan measurements.

The fact and explanation that forest growth (not climate variability) has led to the evapotranspiration increase and runoff decrease in study site is supported by a statistical study of the 23 year data. In the macro perspective, less direct runoff during rainfall and no change of base flow amount over the long term in rain forest is a good forest watershed function.

The simple linear regression model was developed to establish a general relationship between a NDVI and the evapotranspiration factor from Hamon PET. It might be provide an effective predictive tool for determining evapotranspiration rates in forest area that lacking weather data.

## 6 Acknowledgement

This work was supported by JSPS KAKENHI Grantin-Aid for Scientific Research (C) (25420519) and Japanese Alps Inter-University Cooperative Project (Jalps). We acknowledge the important data in experimental forest and the helpful support provided by Gifu Prefecture and Forestry Agency, MAFF. The evapotranspiration estimated by eddy-covariance method and meteorological data at TKC site were provided by Dr. Taku M. Saitoh and Dr. Ichiro Tamagawa of Gifu University.

## 7 References

1. Alkaeed, O., Flores, C., Jinno, K., Tsutsumi, A. (2006). Comparison of several reference evapotranspiration methods for Itoshima Peninsula area, Fukuoka, Japan. *Memoirs of the faculty of engineering, Kyushu University*. Vol. 66 (1).
2. Brutsaert, W. (2005). *Hydrology an Introduction*, Cambridge University Press.
3. Hamon, WR. (1960). *Estimating potential evapotranspiration*. Mass. Inst. of technology.
4. Hewlett, JD., Hibbert, AR. (1966). Factors affecting the response of small watersheds to precipitations in humid areas. Pergamon Press-Oxford & N. Y.
5. Jensen, John R. (2007). *Remote Sensing of the Environment An Earth Resource Perspective* (2nd ed.), NJ: Prentice Hall Series in Geographic Information Science.
6. Johnson, LF., Trout, TJ. (2012). Satellite NDVI assisted monitoring of vegetable crop evapotranspiration in California's San Joaquin Valley. *Remote Sens.* 4, 439-455.
7. Kamble, B., Irmak, A., Hubbard, K. (2013). Estimating crop coefficients using remote sensing-based vegetation index. *Remote Sens.* 5, 1588-1602.
8. Kojima, T., Zainal, E., Oike, H., Ohashi, K., Shinoda, S. (2013). Evaluation of green dam in a forested small catchment with long term hydrological data and tank model. *Journal of Japan Society of Civil Engineers* 69(5), 1\_137-144 (in Japanese with English summary).
9. Komatsu, H., Maita, E., Otsuki, K. (2008). A model to estimate annual forest evapotranspiration in Japan from mean annul temperature. *J. Hydrol.* 348, 330-340.
10. Kondoh, A., Higuchi, A. (2001). Relationship between satellit-derived spectral brigtness and evapotranspiration from a grassland. *Hydrol. Process.* 15: 1761-1770.
11. Kosugi, Y., Katsuyama, M. (2007). Evapotranspiration over Japanese cypress forest. II. Comparison of the eddy covariance and water budget methods. *J. Hydrol.* 334, 305-311.
12. Lu, J., Sun, G., McNulty, SG., Amatya, DM. (2005). A comparison of six potential evapotranspiration methods for regional use in the Southeastern UNITED STATES. *Journal of the American Water Resources Association (JAWRA)* 41:621-633.
13. Ministry of Agriculture, Forestry and Fisheries (MAFF). (2013). *Annual Report on Forest and Forestry in Japan Fiscal Year 2013*.
14. Pomeroy, J., Hedstrom, N. Parviainen, J. (1998). The snow mass balance of Wolf Creek, Yukon: effects of snow sublimation and redistribution. *Wolf Creek Research Basin Workshop*.
15. Prudhomme, C., Williamson, J. (2013). Derivation of RCM-driven potential evapotranspiration for hydrological climate change impact analysis in Great Britain: a comparison of methods and associated uncertainty in future projections. *Hydrol. Earth Syst. Sci.*, 17, 1365-1377.
16. Rao, LY., Sun, G., Ford, CR., Vose, JM. (2011). Modeling potential evapotranspiration of two forested watersheds in the southern appalachians. *ASABE* 54(6): 2067-2078.
17. Report of integrated model work of reinforcing water and soil conserving function (The Kiso region). (2004). Gifu Prefecture. (in Japanese)
18. Saitoh, TM., Tamagawa, I., Muraoka, H., Koizumi, H. (2011). Energy balance closure over a cool temperate forest in steeply sloping topography during snowfall and snow-free periods. *Agric. Meteorol.* 67(3): 107-116.

19. Senay, GB., Leake, S., Nagler, PL., Artan, G., Dickinson, J., Cordova, JT., Glenn, EP. (2011). Estimating basin scale evapotranspiration (ET) by water balance and remote sensing methods. *Hydrol. Process.* 25, 4037-4049.
20. Shimizu, A., Shimizu, T., Miyabuchi, Y., Ogawa, Y. (2003). Evapotranspiration and runoff in a forest watershed, western Japan. *Hydrol. Process.* 17, 3125-3139.
21. Tetens, V.O. (1930). Uber einige meteorologische. Begriffe, *Zeitschrift fur Geophysik.* 6:297-309.
22. Tsukamoto, Y. (Ed.) (1992). *Forest Hydrology*, Bun-eido Publishing Co., Ltd. (Book in Japanese)
23. Ward, AD., Trimble, SW. (2004) *Environmental Hydrology* (2<sup>nd</sup> ed), Lewis publishers.
24. Xu, CY., Singh, VP. (2001). Evaluation and generalization of temperature-based methods for calculating evaporation. *Hydrol. Process.* 15, 305-319.
25. Xystrakis, F. Matzarakis, A. (2011). Evaluation of 13 empirical reference potential evapotranspiration equations on the island of Crete in Southern Greece. *American Society of Civil Engineers (ASCE)*.
26. Zainal, E., Ohashi, K., Sakurai, M., Kojima, T., Shinoda, S. (2012). Long term variable properties of runoff process in a mountainous forested catchment. *Advances in River Engineering, JSCE* 18, 741-476.
27. Zhang, L., Dawes, WR., Walker, GR. (2001). Response of mean annual evapotranspiration to vegetation changes at catchment scale. *Water Resour. Res.* 37(3), 701-708.
28. Zhou, G., Sun, G., Wang, X., Zhou, C., McNulty, SG., Vose, JM., Amatya, DM. (2008). Estimating forest ecosystem evapotranspiration at multiple temporal scales with a dimension analysis approach. *Journal of American Water Resources Association (JAWRA)* 44(1): 208-221.



# REAL COUNT APPLICATIONS SMS GATEWAY BASED FOR FAST, PRECISE, HONEST, FAIR AND TRANSPARENT ELECTION

Amir Alkodri <sup>1)</sup>, Burham Isnanto <sup>2)</sup>

<sup>1)</sup> STMIK Atma Luhur Pangkalpinang, [Arie\\_a3@Atmaluhur.ac.id](mailto:Arie_a3@Atmaluhur.ac.id), 085664641456

<sup>2)</sup> STMIK Atma Luhur Pangkalpinang, [Burham@Atmaluhur.ac.id](mailto:Burham@Atmaluhur.ac.id), 085292016258

## ABSTRAK

Demokrasi yang berjalan baik ditandai dengan adanya pemilihan umum yang jujur, adil, transparan, dan tanpa rekayasa. Penelitian ini bertujuan membuat aplikasi real count perhitungan suara berbasis sms gateway untuk pemilihan kepala daerah setingkat kabupaten yang memiliki jumlah tempat pemilihan suara tidak terlalu besar. Metode yang dilakukan adalah pengumpulan data dengan cara observasi, dan wawancara. Analisa sistem dan perancangan menggunakan UML berorientasi objek dan pengembangan sistem menggunakan metode waterfall. Pengujian dilakukan dengan metode blackbox dengan teknik FGD bersama semua stackholder yang berwenang. Hasil akhir berupa sebuah aplikasi yang bisa dipakai pada saat pelaksanaan pemilihan umum kepala daerah untuk mengetahui data hasil pemilihan umum dengan cepat dan tepat tanpa adanya unsur rekayasa untuk menciptakan pemilihan umum yang jujur, adil dan transparan. Hasil pengujian blackbox menunjukkan tingkat kepuasan stackholder terhadap implementasi aplikasi real count adalah sangat baik.

*Kata kunci: Pemilihan umum, real count, demokrasi, transparan, sms gateway*

## ABSTRACT

Well functioning democracy characterized by elections that fair, transparent, and without fraud. This study aims to create a real count application sms gateway based for local election in district level which has few voting place. The method used is data collection by observation, and interviews. Systems analysis and design using UML and object-oriented. System development using waterfall methode. Testing was conducted using blackbox with FGD technique. The final result is an application that can be used at the time of elections to determine the regional head election results data quickly and precisely without any element of fraud to create fair and transparent elections. Blackbox testing results indicate the level of satisfaction in implementation phase is very good.

*Keywords: Elections, real count, democratic, transparent, sms gateway*

## I INTRODUCTION

Information technology facilitate everyone to finish their work easier. One technology that is widely used and very popular by mobile phone users today are SMS (Short Message Service). This SMS technology has been widely implemented in every lifestyle aspect, such as quiz, polls, forums, academic, banks can even also for business applications such as ordering goods. This research created a concept of service delivery transaction data from the counting of each polling station to the KDP. For this service consists of several types of service concepts such as: Registration no telephone for incoming data validation and data transmission process vote counts per unit of time. With this concept the expected results, validation, accuracy and speed of delivery of vote counts from each polling station will be achieved. So that after the data is entered into the KDP, then when it will also be seen from the number of votes each participant in a local election (sub-district, district, provincial and even central).

Accuracy and information speed is one very important factor today. Especially to the important information services with full of political elements that can cause an enormous impact. To get information on the results of vote counting, must go through several stages and requires a long lead

time. As the counting process at the polling station, after it is sent to the district level to be recapitulated manually and traded to the existing information systems, and there are many procedures that must be passed. Not to mention if the communication connection in this case the internet off or interrupted in the area, or even a power failure. This is of course very troublesome. Therefore, in this paper, load the concept of SMS-based transaction services that can be used to transmit information on the results of the count from polling stations to a unified database system. Thus, difficulties often occur at this time can be reduced or even eliminated altogether.

Problem identification are: there are still obstacles for a candidate in the election knowing vote count, constraints on the time required to wait election and candidate information manual calculation, there is still a chance of cheating when manually counting at each polling station when the election sheet will be sent to recap the calculation and of course the cost is too great for any candidate. We think we need to make restricting the problem to minimize discussion. In this research we discussed was limited only receiving and sending text messages, we developed features sms delivery via operator in accordance with conditions of the user by number, and we develop auto reply for registration and data delivery real count. Based on problem identification and restrictions, this research problems can be formulated as: how to design application information real count to obtain fast and accurate calculation results, how to use the real count application to create better election, minimize its time and fund, and what is the testing FGD result with stackholder about this real count application?

## **II METHODOLOGY**

Research real count sms gateway based we made is an applied research so that the results can be directly applied to solve the problems faced. Research results is an application of real count that will be used to improve transparency in local elections in Babel. The population of this research is a cadre of community organizations of political parties, voting wrought supervisor, team success and local elections stackholder related. Sampling with purposive sampling is a sampling technique by taking selected respondents completely by the researcher according to specific characteristics possessed by the sample. Collecting data methode used :

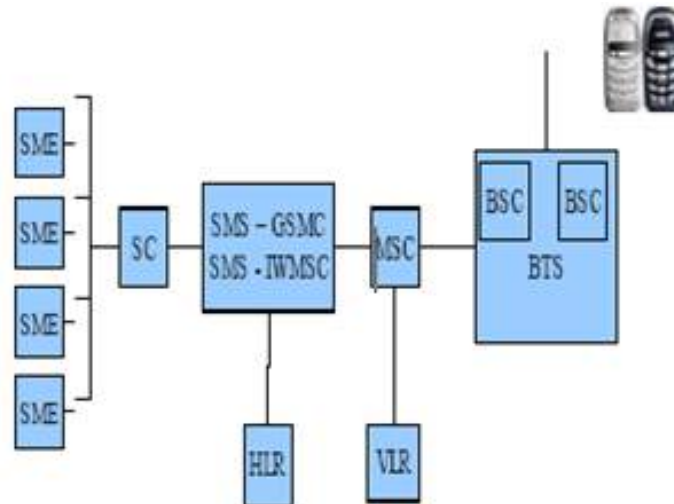
- a. Observation method by conducting field visits and direct observation of the research object.
- b. Interview method, which is done by involving the parties relating to research using black box techniques with a focus group discussion.
- c. Study library methods .

Instrumentation we used:

- a. Instrument for data collection by interview. This interview is a research instrument, some cadres of community organizations, supervisors voting place, and team success in the elections.
- b. The instrument for data collection by observation. This observation is a research instrument that direct observation at the time of preparation of local elections in Babel. List of data needs and data sources observation
- c. The instrument for data collection with library research methods. Instruments of this literature study is that researchers studying the literature on the basic concept of making applications based sms gateway.

## **III DISCUSSION**

Short Message Sevice (SMS) is one of the facilities of DSM technology that enables sending and receiving short messages 0 in the form of text with a maximum capacity of 160 characters from the Mobile Station (MS)<sup>(Gunawan, 2003)</sup>. The maximum capacity depends on the alphabet are used, to a maximum of 160 characters Latin alphabet and for non-latin. Architectural elements and SMS support networks as shown in Figure 1 below:



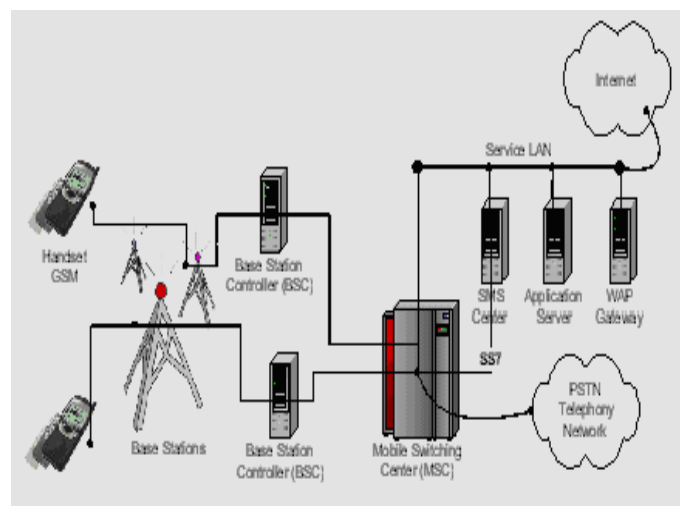
**Figure 1 Elemen jaringan pendukung SMS**

Subsystem that absolutely must exist on the SMS service is:

- SMS (Short Message Entity), the storage and delivery of the message to be delivered to a particular MS.
- SC (Service Center), assigned to receive messages from SME and forwarded to the destination address of the MS.
- SMS-GMSC (Short message Service - Gateway SMC), perform acceptance message from the SC and check the parameters played out in money there. In addition GMSC also search for addresses MS destination with the help of HLR .. and send it back to the MSC in question.
- IWMSC SMS (Short Message Service - Internetworking MSC), plays a role in SmsMessage Originating, which received a message from the MSC.

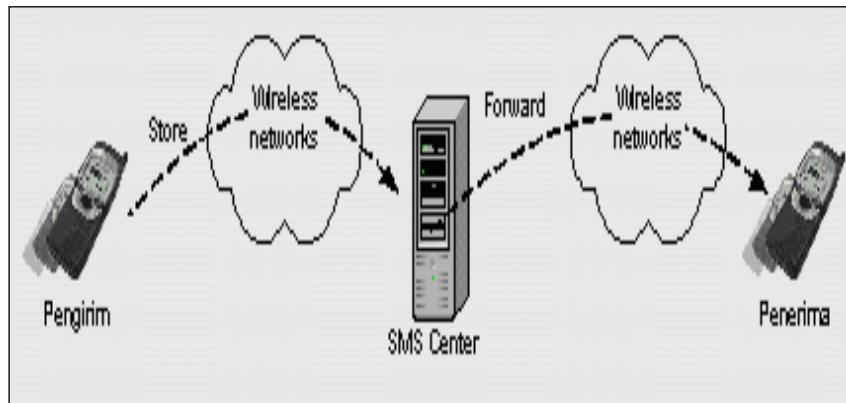
SMS working principle is that every network has one or more Service Center (SC) function:

- Store and forward (store and forwarding fashion) message from the sender to the destination customers.
- An interface between the PLMN (Public Land Mobile Network) GSM with other systems, such as: Electronic mail, facsimile, or a content provider.
- SC is connected to the PLMN via the BSC. Based fungsinya in sending SMS, MSC function can be divided into two:
- SMS-GMSC (Gateway MSC for Short Message Service), namely from the MSC capable of receiving messages from the SC, then search for the routing information to the HLR, then send to vmsc where the customer is located SC
- SMS-IWMMS, namely fungsi from MSC are able to send messages from the PLMN and forward it to the SC.



**Figure 2 Arsitektur Sistem GSM**

(Khang, 2002) In the SMS system, the main mechanism to do is sending a short message from one terminal to another. This can be done to the existence of an entity in the SMS system called SMSC (Short Message Service Centre), also called message center (MC). SMSC is a device that performs the task of store and forward traffic short message. Sending SMS messages in a store and forward of sending SMS to include SMS messages and no goals and then send (store) to the SMSC server which then responsible for sending the SMS message (forward) to the destination. It includes the determination or final destination routing SMS from various sources such as Voice Mail System (VMS), Web-Based Messaging, E-mail Integation, External Short Messaging Entities (ESME), and others.



**Figure 3 Mekanisme pengiriman SMS store and forward**

### 3.1 Proposed Framework

Vote results delivery at the polling station has been carried out by collecting data and documents from each polling station and manually submitted to the tax office or district level to be recapitulated and traded to the existing Information Technology. It is considered to be less efficient, because the number of queues and the volume of work in the LTO will be very dense and full of risks. Based on the existing situation at the moment, then made the concept of service delivery transaction results in the election vote count using the SMS service. The advantages of this SMS service, that the vote count results will be known on a regular basis, because the witnesses listed in the service will send the results of the vote count while for a certain period, for example, for every 30 minutes to send the results of the vote count. Transmitted data will be processed by the SMS-Gateway to a distributed DBMS are in place in each LTO district level. So quickly of votes from each polling station will be in the know, as well as a summary of the number of votes at the district level. As for the level above will be obtained by summarizing of several nodes of each DBMS distributed.

Formats for delivery voting results via sms as follows:

**Table 1 Format sms real count**

No	Ketentuan	Format SMS	Contoh
1.	Pendaftaran Ketua TPS	REG(spasi)NAMA KETUA TPS (spasi) NO_TPS	Contoh : REG Ari Amir Alkodri TPS1
2.	Kiriman Hasil Suara	NO_TPS#Kandidat 1=Jumlah Suara, Kandidat 2=Jumlah Suara, Kandidat 3=Jumlah Suara, Kandidat 4=Jumlah Suara	TPS1#KD1= 60, KD2=40, KD3=45, KD4=30
3.	Kiriman Broadcast	Broadcast dikirim dari Server Kepada Seluruh Ketua TPS bila ingin mengirimkan informasi penting saat pemilihan, Dimana Pendaftaran dilakukan sebelum Pemilihan Bupati	Diberitahukan Kepada Seluruh Ketua TPS waktu Perhitungan Hasil Suara jam 17.00 wib, Diharapkan tepat waktu, Terimakasih. Pengirim : Server SMS Gateway Pilkada
4.	Keluar Dari	UNREG(spasi)NO_TPS	UNREG TPS1

Aplikasi		
----------	--	--

## 3.2 Analysis And System Design

For systems analysis techniques there are some things done that perform data analysis and running information system , perform analysis of functional requirements, non-functional, and user needs as a whole, and perform analysis of system behavior. The needs of the local election campaign team and the needs of every staff in the election will be a major factor that must be catered for. Analyses were also conducted in order to accommodate all possible systems that will happen either of reliability, functionality, accuracy, and usefulness. Mechanical design of the system is done by making use case applications, create an activity diagram, create a WSDL Diagram create a class diagram makes deployment diagrams, database design, and to design the system architecture (hardware, software, networks)<sup>(Raymond, 1995)</sup>. Once the application is completed, system will immediately be tested . The implementation systems process is divided into : implementation environment that includes hardware, software and network are used, the implementation of a database using database software, and system implementation<sup>(Silberschatz, 2001)</sup>

Programming language used to create this application is using java.<sup>(Komputer, 2005)</sup> Java is not just a programming language, but a platform. Many programming languages that do not have features such as multithreading, GUI-building, and capabilities in networking, which must use the hardware or operating-system dependent API (Application Program Interface) to the first fully integrated technology to be able to use threads, sockets, GUI component and many more.<sup>(Purnama, 2003)</sup> In general, the Java Programming Language has several advantages compared to other programming languages, namely: multiplatform: it can run on multiple operating system platforms computer, object oriented programming: a pure object-oriented programming language that allows programmers to mendesainsecara organized, and has a complete library.

## 3.3 User Interface

Main menu display screen is an early look at this application. On the main menu there are three choices menu , ie File, File Real Count Application SMS Gateway, SMS Server and Real Application Count SMS Gateway. If administrators choose the File menu then there are sub menus Log, Log Off, Exit. If the administrator chose the Master File menu, then there is a sub menu Representative Form TPS list members.

### 3.3.1 Login module

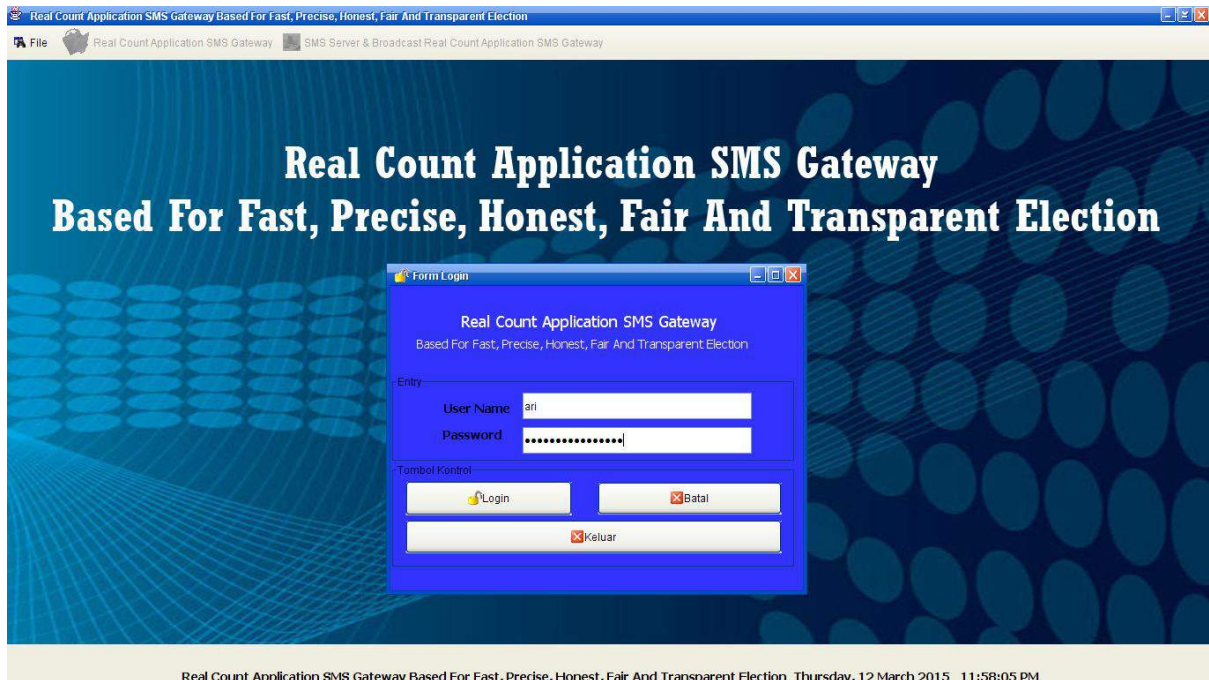


Figure 4 Login Module User Interface

The screen displays the login menu. There are three buttons namely Login, Cancel and Exit. There are computed both User and Password fields. Admin certainly already registered can login into the system.

### 3.3.2 List form representatives election display



Figure 5 List Form Representatives Election Display

The screen displays the data representative of TPS (election place). There are seven buttons add, save, edit, delete, close, search, and refresh. In addition there is also a field that is computed both TPS code, name of the head of the polling station, district and sub-district and find. And display tables

### 3.3.3 List form delivery election result display



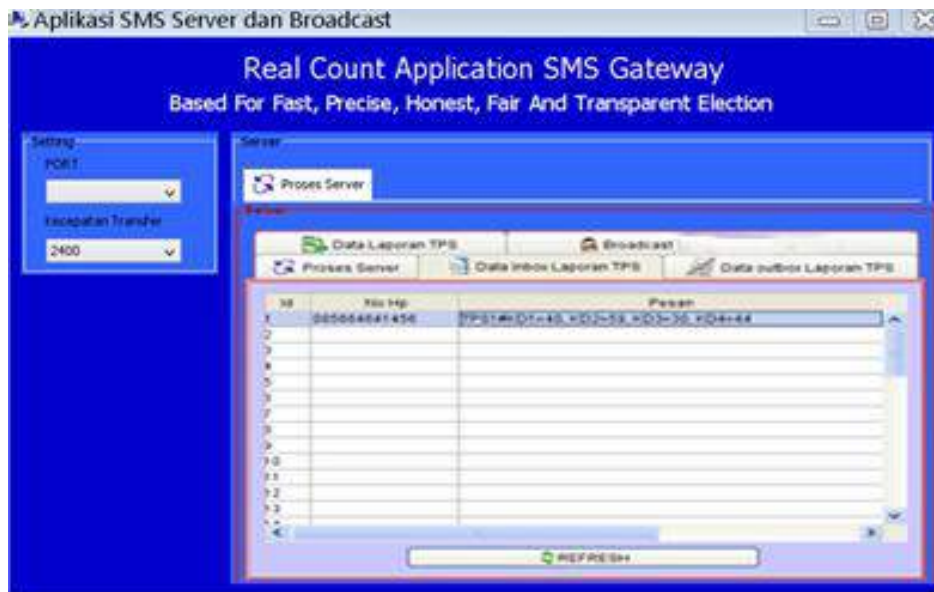


Figure 6 List form delivery election result display

The election result in this screen displays incoming SMS message from the chairman of each polling station to report the results of any election candidate. Which contains the Total Candidate, Candidate Name, number of votes cast.

### 3.3.4 Server broadcast for all user



Figure 7 Server Broadcast for all user

This screen displays the results of application of SMS messages sent from the server Count Application SMS Gateway to All Registered Chairman TPS. Contains information when elections take place.

## 3.4 Blackbox Testing

One of the blackbox testing methods is focus group discussion (FGD). FGD is a research method by Irwanto<sup>(Irwanto, 2006)</sup> is defined as a process of collecting information about a very specific issues through group discussion. Beyond its function as a scientific research method, Krueger & Casey<sup>(Krueger, 1998)</sup> mentions, FGD basically can also be used in a domains and objectives variety, such as decision-making, product development or program, determine customer satisfaction, and so on. According Koentjoro<sup>(Koentjoro, 2005)</sup> uses FGD among others: as a data collection tool, as a means to

ensure data collection (researcher) as well as re-check tool for a wide range of information / information obtained through various research methods used or the information obtained earlier, good description of similar or conflicting. The advantages of FGD by Krueger <sup>(Krueger, 1998)</sup>

- a. FGD is one of the socially-oriented research procedure to put a man on the position and the actual situation.
- b. Forms discussion guides provide flexibility for participants to dig deeper opinion and spacious.
- c. Have a face-to-face high validity and easy to do on the cheap
- d. Results of FGD can be obtained quickly.
- e. FGD allows researchers to increase the size and number of samples without increasing need time for the interview.

The first testing phase is validation testing, the testing process is done to make sure the software that has been made in accordance with the expected functional requirements specification. The activities carried out in the Focus Group Discussion successful team meeting prospective local elections and was attended by 23 participants as respondents, from successful team of 8 people, a witness from the team of 15 people voting. To start the discussion focused, researchers conducted a presentation and demo shows real count applications that have been made and explain any existing functionality based instruments that have been prepared. After notice and know how to operate a real application of this count, then respondents were given the opportunity to try the direct use. Furthermore FGD participants will provide information, feedback and approval form to that already provided by the researcher before the respondent tried on each computer. Form validation testing with FGD. Based on the experiments performed by the respondents, it will obtain the results of functional testing of the system based on the needs of each user. The test is performed to determine whether all the functions contained in this application is able to operate properly or not. Functional testing of systems addressed to all users and sackholder. Based on the results of focus group discussions, it can be concluded that the application of the real count is in conformity with the specification of functional requirements required of the user. Therefore, based on the analysis, design and construction of software for the creation of real applications count based sms gateway to function properly and produce a good validation.

## IV CONCLUSION

Based on the discussion can be summarized as follow:

- a. Real count application sms gateway based can work well to obtain fast and accurate calculation results in the election event.
- b. If there is minimal fraud in the election process, of course the leader choose from that election is the best person who really one society choose. By using this application can minimize the time and fund.
- c. Using blackbox testing by focus group discussion methods with stackholder, election staff, and succes team as responden, we can conclude that the application of the real count is in conformity with the specification of functional requirements required of the user. Therefore, based on the analysis, design and construction of software for the creation of real applications count based sms gateway to function properly and produce a good validation.

## V REFERENCES

- Dharma Oetomo, Budi Soetedjo & Handoko, Yosia, (2003), "Teleakses Database Pendidikan Berbasis Ponsel", Penerbit Andi, Yogyakarta
- Gunawan, Ferry., (2003), Membuat Aplikasi SMS Gateway Server dan Client Dengan Java dan PHP. Jakarta : Elex Media Komputindo.
- Irwanto, J. Focused Group Discussion (FGD) (2006), Sebuah Pengantar Praktis. Jakarta: Yayasan Obor Indonesia



- Khang, Ir. Bustam, (2002), "Trik Pemrograman Aplikasi berbasis SMS", Elex Media Komputindo, Jakarta
- Koentjoro, N. (2005), Metode-Metode Penelitian Masyarakat. Jakarta: PT Gramedia Pustaka Utama, Komputer, Wahana., (2005), Membuat Aplikasi Profesional Dengan Java. Jakarta : Elex Media Komputindo.
- Wahana., (2005), Pengembangan Aplikasi Sistem Akademik Berbasis SMS dengan Java. Jakarta : Salemba Infotek.
- Krueger, Richard A, (1998), Focus Group A Practical Guide for Applied Research, California: Sage Publication Inc, Newbury Park
- Mulyana, Y.B., (2003), Trik Membangun Situs Menggunakan PHP dan MYSQL. Jakarta : Elex Media Komputindo.
- Purnama, Rangsang., (2003), Tuntunan Pemrograman Java Jilid 3. Surabaya : Tim Prestasi Pustaka.
- Raymond McLeod, JR, (1995), "Management Information System A Study of Computer Based Information System 6<sup>th</sup> Edition", Prentice-Hall, Inc
- Silberschatz-Korth-Sudarshan, (2001), "Database System Concepts, Fourth Edition", The McGraw-Hill Companies

## **DESIGN AND IMPLEMENTATION OF COLOR TRACKING METHOD ON CHESS ROBOT USING CAMERA**

Ferrianto Gozali & Daniel Adrian

Jurusan Teknik Elektro Fakultas Teknologi Industri Universitas Trisakti

URL web trisakti : <http://www.trisakti.ac.id/>

Jl. Kiai Tapa No 1, Grogol, Jakarta Barat 11410

E-mail: [ferriantogozali@trisakti.ac.id](mailto:ferriantogozali@trisakti.ac.id), [danieladrianmaster@gmail.com](mailto:danieladrianmaster@gmail.com)

Phone Number : +6287885129698

### **Abstract.**

This research aims to design and implement methods of color tracking on a chess robot to recognize chess pieces. Color tracking is used to obtain the position of chess pieces on a chess board placed distinguished by different colors depending on chess.

The usual method for chess robot is to detect changes in the frame on the image and differentiate the type of chess based feature. In the method of detecting changes in the frame, the robot needs to know the previous frame so that the position of the pieces can not be in realtime. In the method to distinguish the type of pawn based feature errors may occur due to image features that are not detected. By using color tracking, the detection becomes more simple chess robot, realtime and a small error rate.

There are three components of the system are the webcam as input, the computer as a process and a robot controller as output. Webcam function to get the image that will be used to process color tracking. This process is done through a program on a computer. Results of color tracking form 8x8 matrix that represents the position of the pieces on the chessboard. This matrix is then translated into FEN is one of the chess notation used to describe the chess board on the program. Program connected to a chess engine.

Chess engine aims to calculate bestmove for computer. Communication between the chess engine and a program using the UCI protocol. After getting the results from the chess engine, program send command to the robot controller to move the chess pieces. Robot controller and program communicates via Bluetooth.

The capability of color tracking method in recognizing the chess pieces without any error eventhough the lumen of the environments varies is also usefull in other object recognations processes, especially in industrial application.

**Keywords:** *camera,chess,chess board,color tracking,robot*

## 1 Introduction

Robots are now becoming commonplace and be a part of human life. Robot was created to assist human for work. Nowadays, robot is not only made to help people but also for playing with human. One of interesting game is chess. There are many chess robot already made. Chess robot has capability to automatically detects and moving chess pieces. There are two methods used to detect chess pieces that is sensor board [1] and computer vision [2]. The workings of the sensor board is by putting sensors like RFID [3] on each box on a chessboard so that chess pieces can be detected. The workings of computer vision is by using camera to take picture of chessboard and computer will do digital image processing to obtain the position of chess pieces on the board. Sensor board has advantages that can easily detect the position of chess pieces but needs more electronic circuit to obtain the position. With computer vision, chess robot needs less electronic circuit to obtain the position. There are two digital image processing has been used in a chess robot that is feature detection [2] and frame change detection [4].

There are many various ways to process digital images besides feature detection and frame change detection. One of the is color tracking. This method works by detecting color from object and get object position on the image. The advantages of color tracking compared with contour detection is a smaller possibility of error due to the feature detection because environment. Compared with frame change detection, color tracking can directly detect chess positions while frame change detection need different frame to determine the position of chess pieces.

Viewing at the advantages of color tracking method, it is necessary to do reasearch to determine whether the color tracking method can be applied to the robot chess or not.

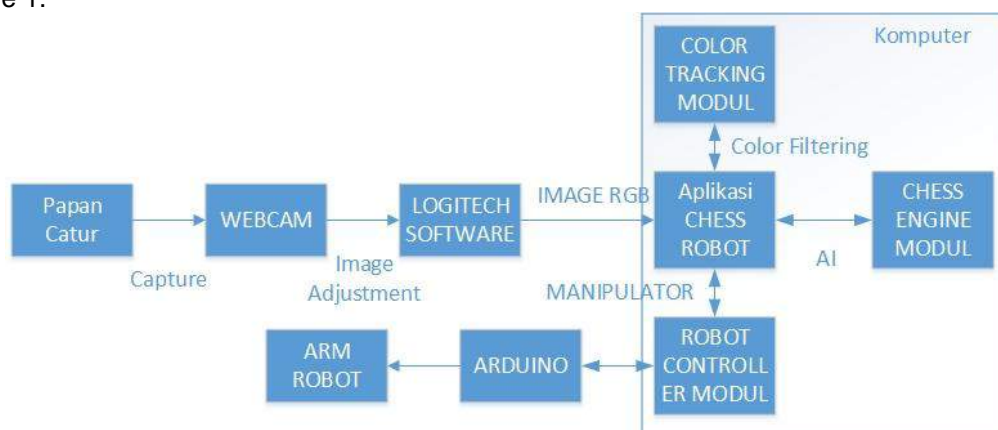
## 2 System Design

### 2.1 General System

There are three component in the system that is webcam for taking picture , computer for processing and robot manipulator to move chess pieces.

Camera is used to taking picture of chessboard. The result image will be send to computer. There are three modul in computer that is color tracking, chess engine and robot controller. Color tracking is used to get chess pieces position in matrix. This matrix is then translated into FEN string is one of the chess notation used to describe the chess board that chess engine can understand. This FEN string will be send to chess engine so that computer can know bestmove to move.

After computer know the bestmove, this movement will be send to robot controller. Robot controller is one of modul in computer. This modul will send servo position to robot manipulator by bluetooth. Chess pieces was made with spesific characteristic. The whole system diagram can be seen in figure 1.



**Figure 1** Chess Robot System Diagram

## 2.2 Input design for chess robot

Input on chess robot system obtained from capture image with webcam. Which later the image will be processed with digital image processing. To make color tacking can detect chess pieces there are several setting for chess pieces, camera, lightning and chessboard.

### 2.2.1 Form of Chess Pieces

Chess pieces is an object to be captured by the camera. Color paper mounted in every chess pieces to distinguish the type of each piece. Colors are selected based on RGB color that is red for the king, blue for the pawn, green for horses, light blue for the queen, yellow for knight and purple for rook. Form of chess pieces can be seen in figure 2.

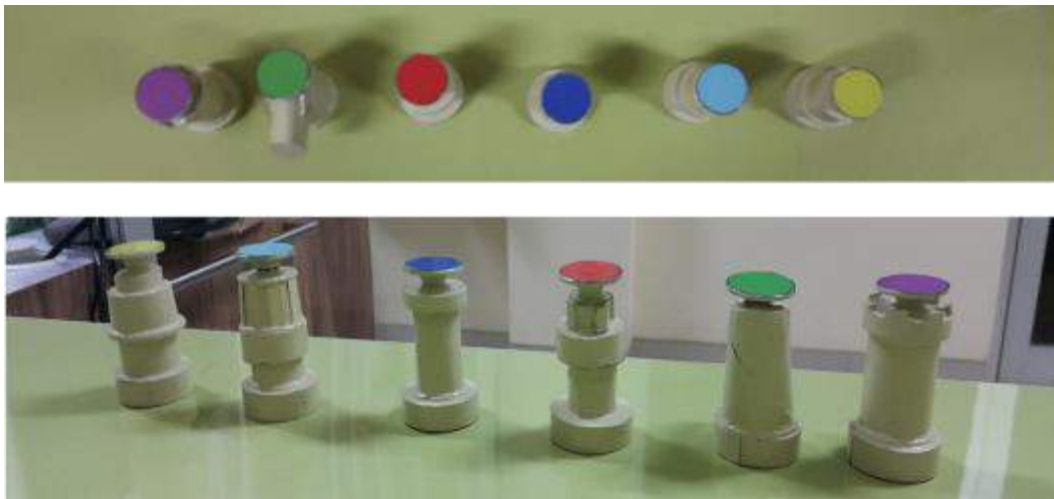


Figure 2 form of chess pieces

### 2.2.2 Form of Chess Board

Chessboard is the background for chess pieces. Chessboard using black and white color. Dimensions of chessboard is 48 cm x 48 cm. Form of the chessboard can be seen in figure 3.

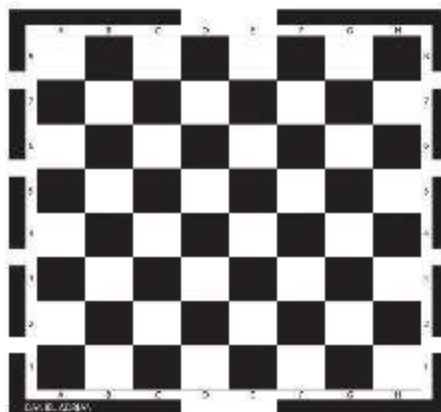


Figure 3 Form of chess board

### 2.2.3 Light and Camera

In this research used two different types of webcam that is logitech c525 as the main camera and logitech c210 as a comparison for testing. Here are the specifications of each camera :

**1. Logitech c525 spesification**

Video resolution : 1280 x 720 pixels

Picture resolution : 8 Megapixels

Feature : Built-in mic, Hi-Speed USB 2.0 certified, Universal clip, Autofocus

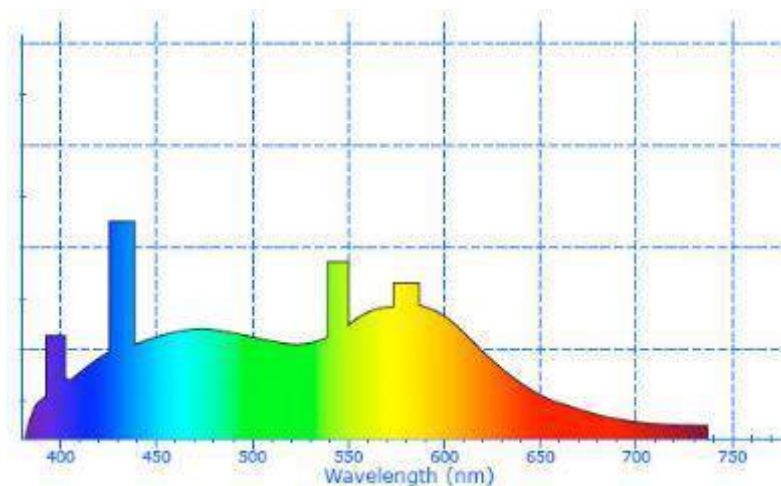
**2. Logitech c210 spesification**

Video resolution : 640 x 480 pixels

Picture resolution 1.3 Megapixels

Feature : Low light adjustment, Built-in microphone

The light that used in this research is light that have 6500K color temperature. In 6500K color temperature, all color can be seen. Color spectrum in 6500K color tempeature can be seen in figure 4.



**Figure 4** Color spectrum on 6500K color temperature

Position for camera and lightning can be seen in figure 5. Camera is placed at the top of the table so that the entire board can be seen clearly.



Figure 5 Light and camera position

## 2.3 Color tracking and bestmove calculation

There are two process that happen in computer that is color tracking and bestmove calculation. This process execute from computer. Here is an explanation of each process :

### 2.3.1 Color tracking design

Color tracking is one of application in digital images processing. Color tracking aims to get a position from the object with certain color. To be able to do digital image processing in VB.NET is required EMGU CV module [4]. There are several step to process color tracking that is :

#### 1. Image Prespective Correction

When camera take a picture from chess board, chess board can be skewed and program cannot detect object correctly. It is necessary to change the image prespective to get correct image as illustrated in figure 6.

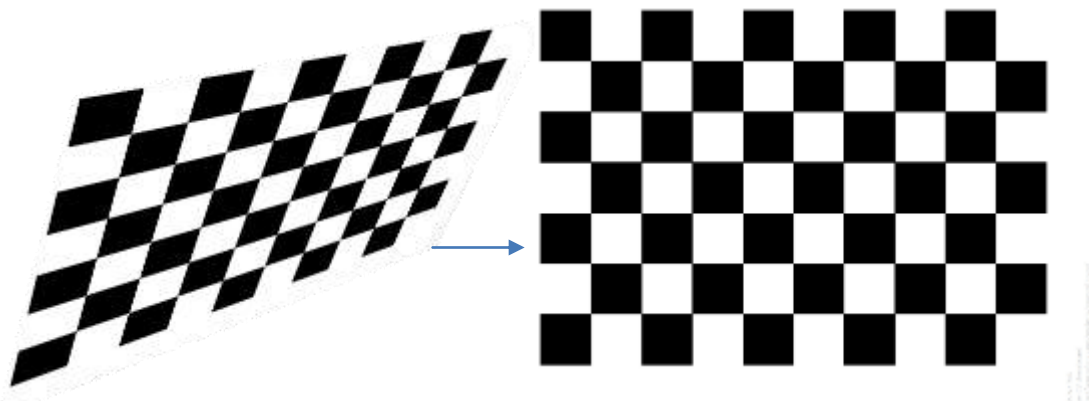


Figure 6 image prespective correction  
Source : <http://www.emgu.com/>

#### 2. Convert RGB image format to HSV image fromat

Images obtained from camera in the form of RGB image format. RGB format is formed by a mixture red, green and blue. RGB color mapping can be seen in figure 7.

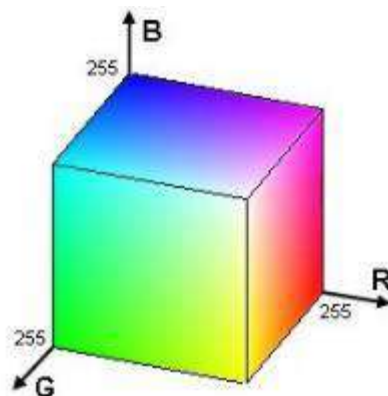
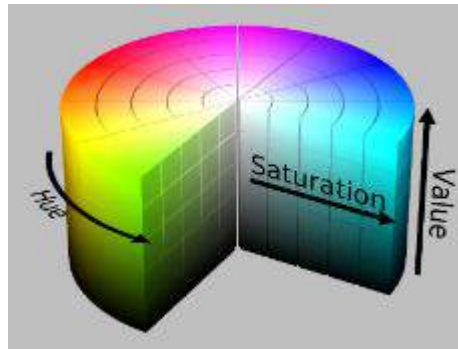


Figure 7 RGB color mapping  
Source : <http://lodev.org/cgtutor/color.html>

In HSV image format, color is obtain by changing hue, saturation and value. HSV color mapping can be seen in figure 8.

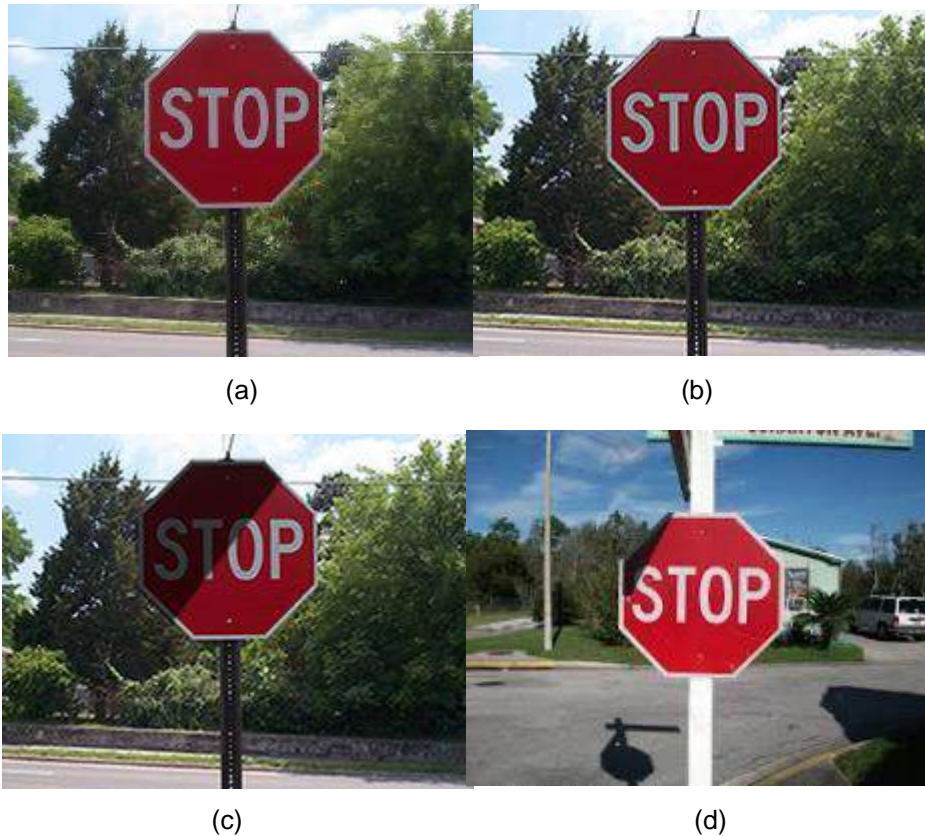




**Figure 8** HSV color mapping

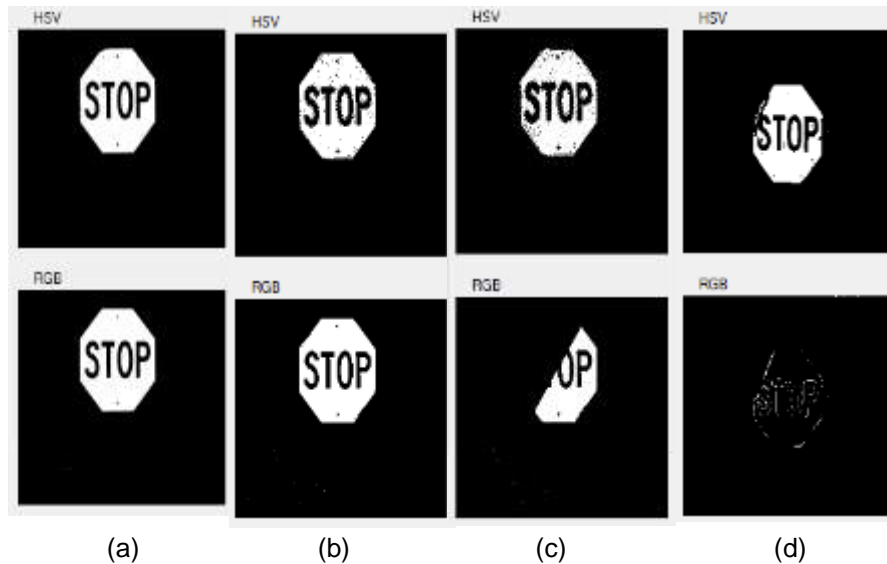
Source : [http://en.wikipedia.org/wiki/HSL\\_and\\_HSV](http://en.wikipedia.org/wiki/HSL_and_HSV)

Comparison is performed to determine it is necessary or not to convert RGB to HSV. Comparison is done by using four different images (Figure 9). The first image has a good image resolution (image 9a), the second image has a low resolution image (Figure 9b), the third image has a low resolution image and placed shadows on objects (Figure 9c) and the fourth image has a resolution images low, there is a shadow, and has a different color light levels (Figure 9d).



**Figure 9** picture that used for comparison

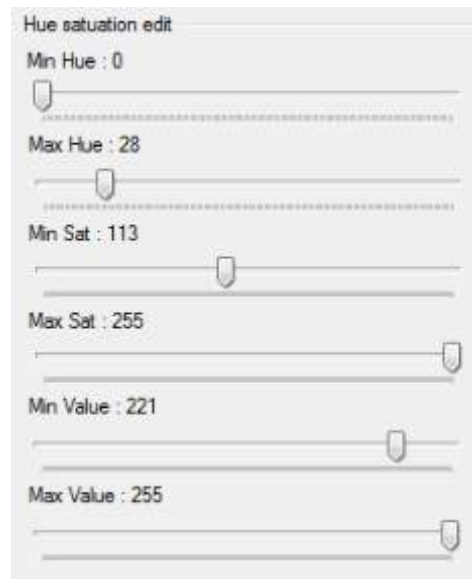
Comparison is done by filtering stop sign in figure 9a by changing RGB and HSV adjustment setting. Then do the same thing for other images with same RGB and HSV adjustment setting that used to filtering figure 9a. the result from figure 10 show that filtering with RGB format is weaker than using HSV format.



**Figure 10** Result from filtering picture in figure 9 for comparison

In figure 10a, both image format can used to filter stop sign. After change picture with figure 9b, there are a few noise in HSV result that can be seen in figure 10b. After change picture with figure 9c, RGB cannot filter it well because there are shadow that change red color but HSV can filter it well because HSV break apart between color and saturation (figure 10c). This problem also happen to RGB after change picture to figure 9d (figure 10d). Based on this comparison, convert RGB format to HSV format is necessary.

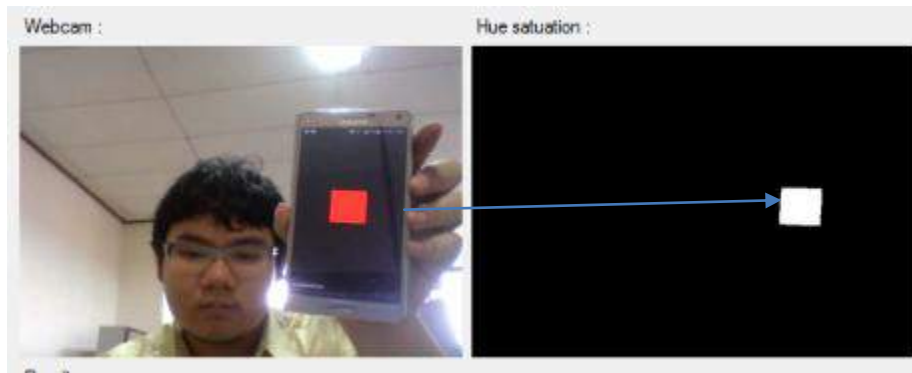
### 3. Color Filtering



**Figure 11** Setting HSV minimum and maximum

Color filtering can be done by setting hue,saturation and value minimum and maximum that can be seen on figure 11. This setting determine which color that filtered in color tracking. Color that filtered by program will be changed into white color and the other colors change into black color. It can be seen on figure 12.





**Figure 12** filtering red color

#### 4. Find Contour

Find contour is used to search white area in filtered image that can be seen on figure 12. While doing filtering the white area sometimes incomplete or imperfect. Problem can be solved by make white area bigger so that the area can be seen clearly. After find contour, contour position can be obtained by get middle x and y contour in image (figure 13).



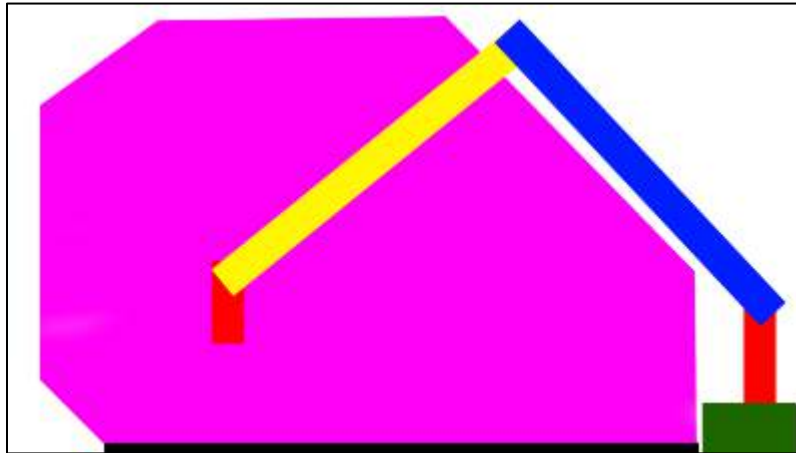
**Figure 13** Object position in image

#### 2.3.2 Best move calculation

To calculate best move for playing chess, program needs chess engine module. Chess engine that have been used in program is stockfish. Chess engine and program communicated with UCI protocol. In order chess engine can know board position program needs to convert matrix notation to FEN string. After program send board position, chess engine will do the calculation. After finish it will return best move for computer.

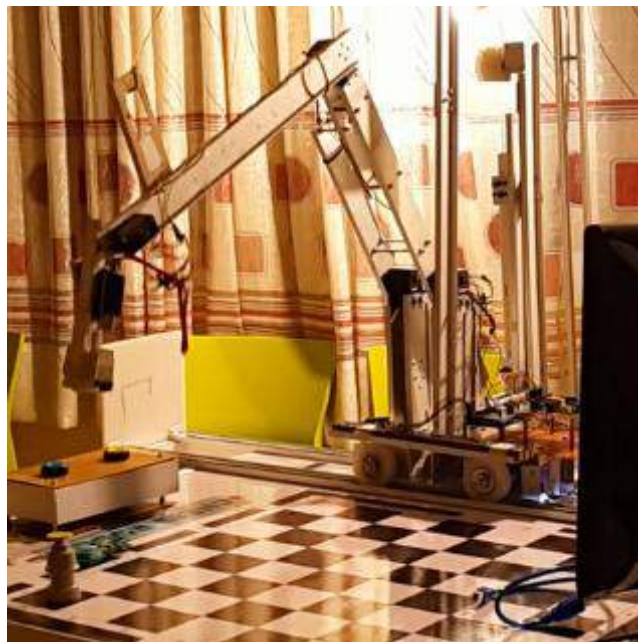
#### 2.4 Robot Manipulator

In order to control robot manipulator, controller is needed. Controller that used in this robot is arduino mega 2560. This controller is connected to the computer using bluetooth module. Chess robot designed using aluminium. Robot have three degree of freedom and one gripper. There is a rail which serves to move the workspace of the robot. The meaning of the workspace is possible positions that can be taken by hand. Workspace can be seen in figure 14.



**Figure 14** Workspace(purple) for robot manipulator

In each joint, robot used servo to move. Servo that used in robot is dynamixel AX-18 for arm and bluebird BMS 660 MG for gripper. Form of the robot can be seen on figure 15.



**Figure 15** Robot

On the rail, there are black line to determine position for the workspace. There are ten position of the workspace that is for trash, for button and for chessboard. It can be seen on figure 16.



**Figure 16** black line for robot position

### 3 Result

#### 3.1 Testing the effect of different lumen on color tracking

The purpose of this testing is to know whether lumen changes can influence color tracking. In this test, three lamp is used to determine the different of lumen i.e. 250 lumen, 600 lumen and 806 lumen. The result of this test can be seen on table 1.

**Table 1** The effect id different lumen on color tracking

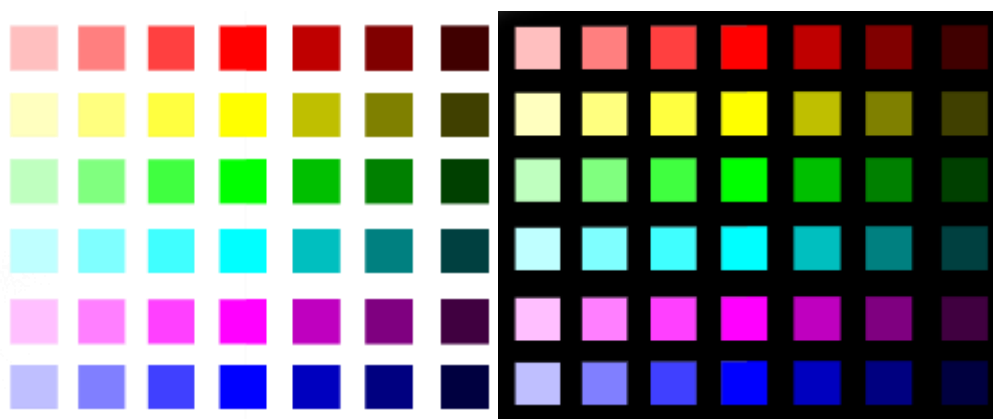
Chess pieces color	250 lumen as reference			600 lumen as reference			806 lumen as reference		
	250	600	806	250	600	806	250	600	806
Blue	✓	✓	✓	✓	✓	✓	✓	✓	✓
Red	✓	✓	✓	X	✓	✓	✓	✓	✓
Light blue	✓	✓	✓	X	✓	X	✓	✓	✓
Green	✓	✓	✓	✓	✓	✓	✓	✓	✓
Purple	✓	✓	X	✓	✓	✓	X	✓	✓
Yellow	✓	✓	✓	✓	✓	✓	✓	✓	✓

Information : ✓ (Detected)

X (Not detected)

#### 3.2 Testing the effect of color saturation and value on color tracking

This test is performed by using a various different saturation and value capture by camera logitech c525. There are two background that used in this test i.e. white color and black color that used for chess board. Color that have been used in this test can be seen on figure 17.



**Figure 17** Color that have been used

Testing is done by filter color in figure 17 for white background and black background. The purpose of this test is to know how good color tracking can filter various saturation and value in color. The result for white background test can be seen on table 2 and table 3 for black background.

**Table 2** color filtering result in white background

Saturation/value	Blue	Purple	Light blue	Green	Yellow	Red
Saturation : 25% Value : 100%	✓	X	X	✓	✓	X
Saturation : 50% Value : 100%	✓	✓	✓	✓	✓	✓
Saturation : 75% Value : 100%	✓	✓	✓	✓	✓	✓
Saturation : 100% Value : 100%	✓	✓	✓	✓	✓	✓
Saturation : 100% Value : 75%	✓	✓	✓	✓	✓	✓
Saturation : 100% Value : 50%	✓	X	✓	✓	✓	X
Saturation : 100% Value : 25%	X	X	X	X	X	X

Information : ✓ (Detected)

X (Not detected)

**Table 3** color filtering result in black background

Saturation/value	Blue	Purple	Light blue	Green	Yellow	Red
Saturation : 25% Value : 100%	✓	X	X	✓	✓	X
Saturation : 50% Value : 100%	✓	✓	✓	✓	✓	✓
Saturation : 75% Value : 100%	✓	✓	✓	✓	✓	✓
Saturation : 100% Value : 100%	✓	✓	✓	✓	✓	✓
Saturation : 100% Value : 75%	✓	✓	✓	✓	✓	✓
Saturation : 100% Value : 50%	X	✓	✓	✓	✓	X
Saturation : 100% Value : 25%	X	X	X	X	X	X

Information : ✓ (Detected)

X (Not detected)

### 3.3 Testing the effect of different type of camera on color tracking

The test is performed by using a fixed light and same angle camera, but by replacing the type of camera. Camera that used in this test is logitech C210(Camera 1) and logitech C525(Camera 2). Testing is done by using adjustment to track color with camera logitech c525 then see whether after switch logitech c525 with logitech C210, the program still can perform color tracking. So it's same method for testing with logitech c210 as reference and logitech c525 to know whether program still can perform color tracking after switch camera. The result can be seen on table 4.

**Table 4 Result**

Color of chess pieces	Using camera logitech c525 as reference		Using camera logitech c210 as reference	
	Camera 1	Camera 2	Camera 1	Camera 2
Blue	X	✓	✓	✓
Red	X	✓	✓	X
Light Blue	✓	✓	✓	X
Green	X	✓	✓	✓
Purple	X	✓	✓	✓
Yellow	X	✓	✓	X

Information : ✓ (Detected)

X (Not detected)

### 3.4 Testing movement detection with color tracking

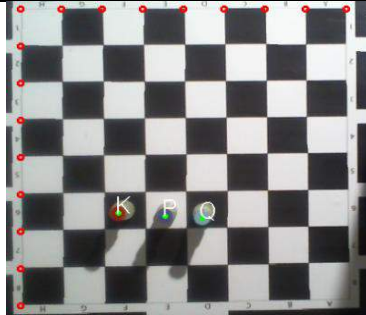


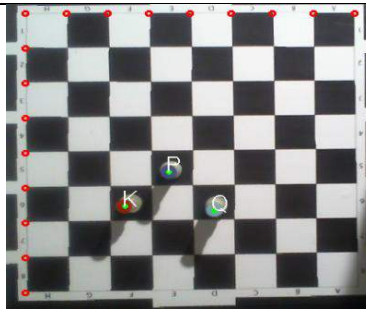

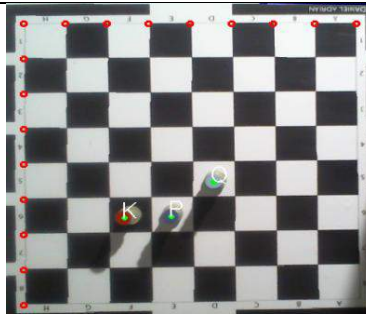
One of color tracking purpose is to detect the movement of the chess pieces. To do this, color tracking position will be convert into matrix that represented chess board (Figure 18).



**Figure 18** Matrix representasion for chess board

By changing color tracking results into a matrix the movement can be detected. Test carried out using three chess pieces with different colors. With this setting, testing is done by move piece one by one to know whether program can detect movement. The result for this test can be seen in table 5.

**Table 5** Movement detection

Previous position	Next position	Result
		<div style="border: 1px solid gray; padding: 5px; display: inline-block; margin-bottom: 10px;"><b>K-2,5-2,4</b></div> <p>King from (2,5) to (2,4)</p>
		<div style="border: 1px solid gray; padding: 5px; display: inline-block; margin-bottom: 10px;"><b>P-3,5-3,4</b></div> <p>Pawn from (3,5) to (3,4)</p>
		<div style="border: 1px solid gray; padding: 5px; display: inline-block; margin-bottom: 10px;"><b>Q-4,5-4,4</b></div> <p>Queen from (4,5) to (4,4)</p>

#### 4 Conclusion

1. Color tracking can be implemented in a chess robot
2. Changes in lumen 250,600 and 806 cause error in several color but this problem can be solved by adjust the setting
3. Saturation level can still be detected by the camera to the optimum for white background and black background between 50% to 100% for value 100%
4. Value level can still be detected by the camera to the optimum for white background and black background between 75% to 100% for saturation 100%
5. The robot is able to know the chess pieces are moved by human
6. Differences camera represented by logitech c525 and logitech c210 showed that different camera affect the results of chess pieces detection

## 5 References

- [1] Konstantin Kosteniuk. Retrieved desember 15, 2014 from  
<https://chessprogramming.wikispaces.com/Konstantin+Kosteniuk>
- [2] Cynthia, M., Brian, M., Roberto, A., Marc, P.D., Liefeng, B., Robert, C., Mike, K., Louis, L., Joshua, R.S., Dieter, F.(2013). Gambit: A Robust Chess-Playing Robotic System. University of Washington
- [3] Mrs. Sonal, D., Prof. V. B. Baru.(2013). Applications of RFID in Interactive Board Games. Sinhgad College of Engineering
- [4] Emir, S., Melita Ahic-Djokic.(2008). Simple computer vision system for chess playing robot manipulator as a Project-based learning example. Faculty of Electrical Engineering, University of Sarajevo
- [5] EMGU CV Retreived desember 15, 2014 from  
<http://www.emgu.com/wiki/>
- [6] Kyle, H.(2013, September 21).OpenCV Tutorial: Multiple Object Tracking in Real Time [Video file]  
Retrieved from <https://www.youtube.com/watch?v=4KYIHgQQAts>
- [7] Kyle, H.(2013, March 11). Tutorial: Real-Time Object Tracking Using OpenCV [Video File].  
Retrieved from <https://www.youtube.com/watch?v=bSeFrPrqZ2A>



## Model for integrating peer-interaction into eBook technology

<sup>1</sup>Nazia Nishat & <sup>2</sup>Yousuf Mahbulul Islam

<sup>1</sup>Daffodil International University, nazia.swe@daffodilvarsity.edu.bd, +8801681466687

<sup>2</sup>Daffodil International University, ymislam@daffodilvarsity.edu.bd, +8801711876909

### Abstract.

Modern teaching techniques engage students in class and in the subject content through peer interaction as a method of learning. Increasingly, ICT tools are being used to implement such interaction. Handheld devices such as iBook, iPad, tablets, eBook reading devices have recently gained momentum as they provide reading access to subject content. Such devices use text, images, audio, video, animation and interactivity such as playing games and question/answer sessions. As the eBooks and animation games are generally downloaded to the handheld devices, the environment in the local device does not provide facilities whereby students can share ideas on the content, discuss, share problems and involve themselves in the content through peer-interaction. This article looks into the current eBook reading technologies and the role of stakeholders involved in preparing and delivering content to the users. Having looked at the total environment involved, the article proposes a theoretical model where the eBook technology can be combined with the benefits of peer-interactivity. In the proposed model the eBook author provides content and questions, the publisher publishes contents as HTML content, the instructional designer designs the interactivity, teachers can task students to get involved by selecting relevant content for subject learning and students can engage by commenting on images and paragraphs, asking questions and sharing their problems as needed for peer interaction.

**Keywords:** *eBook; eBook readers; interactive eBook; peer-interaction; e-Learning*

### 1 Introduction

In recent years books in electronic format or eBooks available on the Internet and the number of hand-held devices on which such books are available has increased drastically. So much so that, as reported by MacWilliam (2013) Princeton University, National Institute of Standards and Technology (NIST), Queensland University of Technology, UCLA and the Pew Research Centre have all recently done evaluations of various eBook reading devices from a variety of angles. The studies involved university students and libraries, textbooks and fiction, comparison between different eBook readers, functionalities and interactivity.

MacWilliam (2013) has reviewed each of these studies and the angles from which the evaluations were done. He points out that we are now in the Fourth Generation of eBook readers while giving a review of all four generations. The latest generation features multifunctional technology with embedded videos and audio as well as animation facilities and Internet connectivity. He points out,

“Tablet computers, the fourth generation of eBook device, also offer a reading platform but are layered with other applications and do not offer a dedicated reading environment but a multimedia experience. Their advantage is that they offer multimedia content and platforms on which enhanced eBooks and eBook apps can be developed. It is because of these devices that the eBook is now much more than a digital version of its printed predecessor.” {p.3}

While tablet PCs are competing in technically attractive abilities, i.e. speed, memory space and apps, all these additional features represent a departure from the traditional paper-based book. MacWilliam (2013) concludes that “Enhanced eBooks and eBook apps are the focus for many publishers today and a way to offer an enriched user experience that enhances the book with multimedia.” In contrast, a comprehensive study done by Wilson (2001) more than 12 years ago insisted on enhancing the paper-based book experiences that readers traditionally enjoy. MacWilliam (2013) therefore studied what he calls the “Emotional Factors” involved in reading by readers. Such personal emotional factors, as also echoed by Roxburgh (2012), play a factor in the popularity of reading as an activity. To understand how young people relate to the written word and corresponding multimedia a 25-year

old was interviewed. This 25 year old had read all the Harry Potter books and watched all the corresponding movies. She had also read Lord of the Rings and watched the movie of it. She said, "The Harry Potter books were way better than the movies. The language in the books is so descriptive that it just allowed my imagination to soar – often with me in it. The (Harry Potter) movies on the other hand represented imagination of a very limited kind – maybe because of the producer or perhaps the movies were hurriedly made to cash in while the popularity was at its peak. In contrast, the movie *Lord of the Rings* was, I felt, better than the book. The book, in parts was difficult to understand – so the movie interpreted the book for me."

So for this young person reading enjoyment is related to ease of comprehension and for the imagination to be involved. Much therefore depends on the author's or movie's ability to capture the imagination of the reader.

## 2 Academic Texts

Much of the efforts towards ebooks are directed towards the enjoyment of fiction and literature reading. To find the need of students studying academic texts, the E-reader pilot at Princeton University (2010) involved a number of batches of university students where they compared the electronic version books with similar paper-text in various aspects. In the face-to-face interviews, the students had something interesting to say. They wanted some features that facilitate learning, such as ability to **highlight** text and write notes against the **highlighted** or marked\* text. This pointed to something new – the need for the same features as that used by students to learn from hard copies. Such features are unnecessary for general fiction reading but essential for academic text where students not only need to comprehend text but they also need to apply their learning in various situations. To do so, sometimes they need to be able to refer back to the **highlighted** text or to the notes they have made. The authoring tools now available therefore not only allow the addition of interactive multimedia content, they also have features for highlighting and note taking as shown in Figure 1.



Figure 1. Interactive features of an eBook (Authoring tool, Kotobee, 2014)

Figure 1 shows an authoring tool that allows insertion of audio and video clips, an interactive dictionary, insertion of animation, highlighter, taking of notes, doing exercises as well as exporting the application to android devices, iPads and iPhones, etc., as a handheld application. All these interactive possibilities are geared to engage the individual learner into the content. This study explores whether these interactivities can be classified as Active Learning and proposes a theoretical model that would help incorporate Active Learning activities.

### 2.1 Active Learning Activities

To decide whether the interactivities promote active learning, we need to look at definitions. As reported, Felder & Brent (2009, cited in CTE, 2014) define active learning as

"anything course-related that all students in a class session are called upon to do other than simply watching, listening and taking notes" (p. 2).

Therefore, watching a video, listening to an audio clip, or even taking notes is not classified as active learning as these activities can be passive and do not necessarily engage thinking. To engage thinking, the learner needs to take active decisions, *e.g.*, decide whether a thought is wrong and why it is wrong, or why a thought is right and why it is right. In other words, as pointed out by Bonwell and Eison (1991, as cited in CTE, 2014)

"Active learning is "anything that involves students in doing things and thinking about the things they are doing" (Bonwell & Eison, 1991, p. 2)."

The reader, viewer, listener must actively think about the subject by sharing ideas or by applying thoughts. This can be done when students work in pairs or groups and have the chance to,

"When learners work in pairs and small groups, they can engage in communicating ideas, in co-operating to accomplish goals, in peer review of each other's work, and in coaching." (UNICEF, 1999).

Peer reviewing each other's work, peer-coaching, collaborating, asking each other questions and providing answers would classify as active learning and would help develop higher order thinking skills required at tertiary level of education. This need of students points to a student-centric approach that was previously overlooked by manufacturers of the technology. MacWilliam (2013) therefore concluded:

"As further developments are made and new ebook devices are released, understanding has to be given to a human-centered approach that will help to better the design of ebooks and best utilize the technology. Although publishers cannot affect the technology on which the device is read, they can affect the contents and further enhance the reader's experience. The publishing industry needs to think innovatively and use a human-centered approach to development that will allow them to design for more engaging experiences." (p.10)

What is a human-centered approach? It is a design approach that serves the needs, tastes and habits of readers in this case. The respondents in the Princeton University (2010) survey also talked about their "learning" habits and the need to incorporate support features to cater for such habits. This leads us to think more about how ebooks can be used to support classroom teaching-learning practices and in particular active learning techniques used by teachers and instructional designers.

### **3 Incorporating Active Learning Activities in eBook Technology**

More recently, as reported by Fenwick et.al. (2013) Apple released the free iBook Author application during January, 2012 for the iPad mobile handheld device. As reported by Fenwick (2013), Langer (2012) describes the features of the iBook Author application as:

"The iBooks Author application supports a wide variety of content types including text, images, shapes, tables, charts, and interactive widgets. Each content type has changeable characteristics, such as text font size, shape color, etc. The content types can be placed anywhere on a page. A number of interactive widgets are available including image galleries, audio media (m4a format), video media (m4v format), slideshow presentations, multiple-choice review questions, an "interactive image" that supports image zooming and labeling, COLLADA format 3-D objects allowing the reader to manipulate the object, and embedded Dashcode HTML." {p.2}

Using these technological features, Fenwick et.al. (2013) report on how they developed a highly interactive eBook for teaching students the fundamentals of a Computer Science language Prolog. While it was possible to link to external quiz and grading systems, the application itself did not have means of monitoring whether a student is actually using any of the interactive tools. It is important to monitor student engagement or participation as a part of good teaching practices. Monitoring, however, requires that the teacher be able to "see" what the student is doing. How would a teacher see what the student is doing if the responses are stored locally in the tablet? How would the teacher get access? In addition, the application did not allow peer support for learning or group activity support for students to do group projects together.

## 4 Pedagogical Features

In addition to be able to monitor student activities, a teacher may want additional pedagogical features or instructional design support from a particular ebook that the teacher is using as a textbook for his/her course. Additional pedagogical features may include employing active learning strategies to engage with particular content in the textbook. Prince (2004) reviews the forms of active learning strategies used in engineering classes which include collaborative learning, cooperative learning and problem-based learning (PBL) all of which require group interaction. With the exception of PBL which may also have an element of self-directed learning, all active learning strategies involve some sort of interaction with peers, resources (textbooks, self-assessment quizzes, laboratory equipment, learning games, etc), teachers or experts. Such activities online may take the form of discussion, comments, feedback, etc. – all of which need purposely built spaces where such interaction can take place and viewed by the peers involved. The activity or discussion needs to be tied to the content in question.

The teacher, being the assumed expert, would know which parts of a concept need to be discussed so that students could actively engage through discussion and make the required learning connections. Making such connections is essential for learning as the neuropsychology experts have also shown by research in their revised book (Caine & Caine, 1994). They also advocate a non-threatening motivating environment, which social networking sites allow. Ideally, therefore, subject content given in paragraphs, figures or exercises need a facility similar to that provided by social networking sites, e.g., discussion on a paragraph, figure, problem or exercise given by a teacher in an academic text.

So, a subject teacher may feel that it is essential to discuss and understand a particular diagram or a particular section of text in an academic ebook being used a textbook. The teacher may also want to follow the discussion either actively or silently or even give a formative feedback at the end of a discussion. The question is what functions/facilities of an academic ebook would allow a teacher to do this? Certain steps would be necessary.

1. The teacher would need access to the diagram or part of text in the ebook.
2. The teacher should be able to assign a discussion task by writing a question for the text or diagram
3. The task should be accessible to a particular batch of students taking the course
4. The students should know what tasks are given on the diagram
5. They should be able to comment, discuss and see all other posts on the text or diagram
6. The teacher should be able to assist the discussion, give formative/cumulative feedback and also assign marks if planned and announced.
7. If assigned by the teacher, the system should be able to automatically give participation marks based on authentic participation.
8. The individual marks and feedback should be accessible to the student.

Such features represent a paradigm shift in the way academic ebooks are downloaded and used in personal hand-held devices. To allow such functions to exist in and integrated into academic ebooks, the ebook must be held in a website and work interactively with the personal hand-held device rather than being entirely downloaded and stored locally with the multimedia features. In addition, to incorporate full active learning features in content, the services of an instructional designer as well as graphics designers may be necessary. For an author alone, who may or may not be an expert at instructional design, it would be too time consuming to use a tool such as Kotobee (2014) and produce fully active learning content.

## 5 Proposed eBook Development Model

All this points to the need for an overall eBook development model which publishers and authors can refer to adopt their particular features for the market they wish to address. The model would be three-pronged, i.e. it would involve an integrated approach with

- Content
- Technology
- Pedagogy

The content must obviously be useful and written in an engaging manner that lends itself to a variety of interactive activities. The technology would support all interactive and pedagogical activities. And of course the pedagogy would involve active learning design features. The types of people that would be involved in publishing and using eBooks would potentially be

- Authors
- Publishers
- Instructional designers
- Teachers
- Students

Those involved with the technology would have to cater to the needs of the all the stakeholders. The publishers and author will collectively decide which market they are aiming for. The eBook Development Model shown in Fig. 1 is meant as a starting point to think about the issues involved in publishing an eBook.

Preliminary ideas for each of the three areas, content, technology and pedagogy are given in Fig.1. With this model the roles of the stakeholders has also to be reassessed.

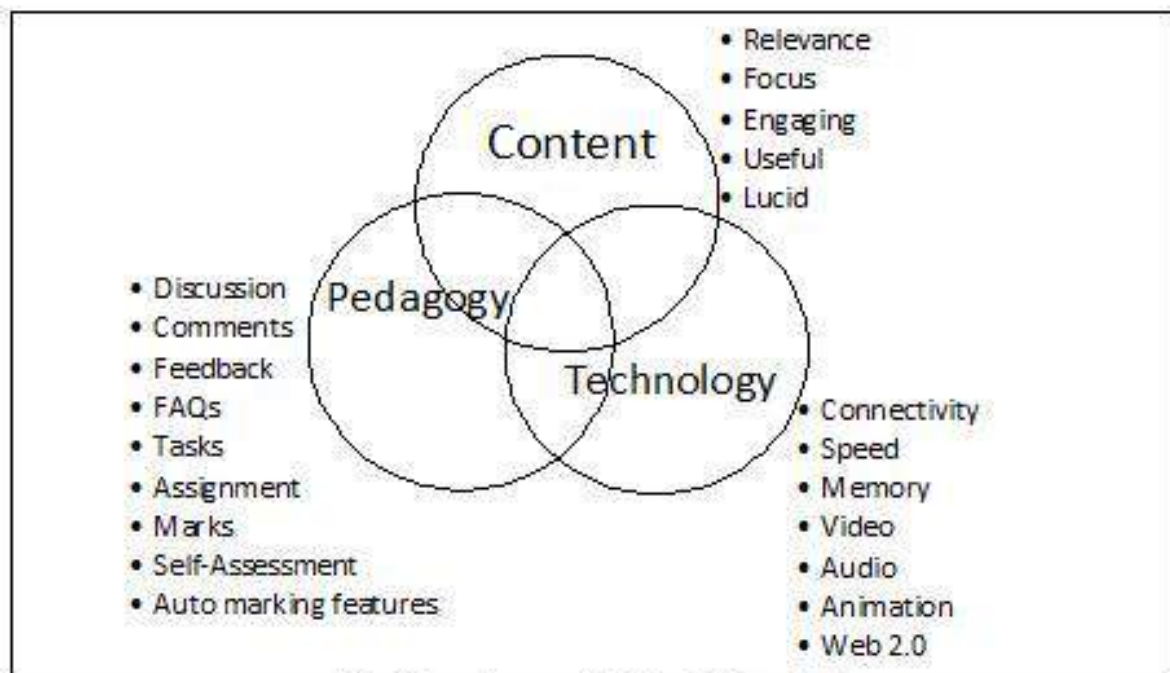


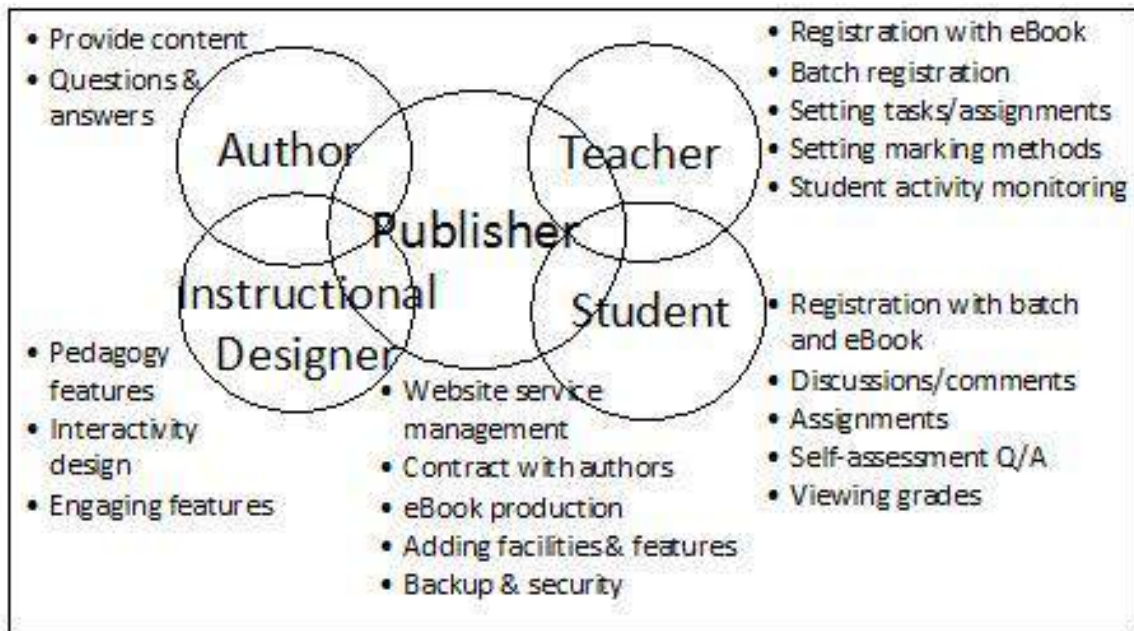
Fig.1 Developmental Model for eBooks

## 6 Roles and Interactions

The stakeholders, interactions and potential services are shown in Fig.2. The publisher would provide the website services where all the eBooks would be created and maintained with all the services. The publisher would solicit authors or textbook writers to either convert their existing textbooks to eBooks or contract to write new books. The publisher would engage the instructional designer to add/suggest pedagogy, interactivity and engaging features.

The publisher would then allow teachers who wish to use a particular textbook to register batches of students. Students would register either through the educational institution or directly with the publisher and do all the assigned work with the textbook. Publishers may even have bulk contracts with universities to provide text eBook services. Illegal sharing of textbooks would not be possible as

the textbook would not be available as a pdf file. Publishers could then afford to charge a much reduced fee for use of the textbook.



*Fig.2 Interrelationships and Roles of Various Stakeholders*

## 7 eBook Features

The eBook design would essentially allow interactivity on each diagram or line/sentence/paragraph of text. This means that each diagram or part of text would have to be uploaded separately and allow task setting, peer discussion, comments, feedback, self-assessment questions, marking scheme, grading, animation, video and audio. Ebook readers would allow logging in and after authentication allow all the student activity, interactivity and interactions. It would keep a log of all student activity. It would then allow teachers to monitor the activity and provide feedback when needed. Publishers could provide students with a host of additional support services, such as access to an author FAQ site.

## 8 Conclusion

A web 2.0 based eBook service offered by publishers would allow a full range of pedagogical features to be added to eBooks used as textbooks. This would allow textbook activity to be not only guided but also monitored while giving the necessary feedback. Currently, tablet PCs have become very popular with university students. Students use these to read textbooks in the form of eBooks, which are mostly pdf files shared between classmates or passed down from seniors. Such sharing leads to loss of potential revenue which can be avoided by using a web-based eBook service. Each student logging in would pay a nominal charge or use the bulk membership facility enjoyed by the educational institute. Wilson (2014) does thorough research to show the disruptive side of ebooks claiming that aspects of book production, distribution and use has been adversely affected and raises the following questions for the future in his conclusion:

- Will self-publishing of e-books continue to grow?
- Will universities enter the open access textbook market?
- How will publishers integrate their systems for the simultaneous publication of printed books and e-books?



- In small language countries (e.g., countries that do not use English as a medium of instruction) what systems of collaboration among publishers and booksellers will evolve?
- Which categories of books are likely to exist only in e-book form?
- How will bookshops respond to the challenge of the e-book?
- Will online e-book selling dominate the book market? And many more.

It is hoped that the ebook model presented will help the stakeholders analyze these questions in a better light.

## 9 Reference

- Bonwell, C. C., & Eison, J. A. (1991). *Active learning: Creating excitement in the classroom (ASHE–ERIC Higher Education Rep. No. 1)*. Washington, DC: The George Washington University, School of Education and Human Development as cited in CTE (2014).
- Caine, G. & Caine, R.N. (1994). *Making Connections: Teaching and the Human Brain*. Addison Wesley.
- CTE, Cornell. (2014). Active Learning. Website. Center for Teaching Excellence, Cornell University. Retrieved March 31, 2015 from <http://www.cte.cornell.edu/teaching-ideas/engaging-students/active-learning.html>
- Felder, R.M. & Brent, R. (1996). Navigating the bumpy road to student centered instruction. As cited in CTE (2014)
- Fenwick Jr., J.B., Kurtz, B.L., Meznar, P., Phillips, R. & Weidner, A. (2013). Developing a highly interactive eBook for CS Instruction. *Proceedings of the 44th ACM technical symposium on Computer science education*. <http://dx.doi.org/10.1145/2445196.2445241>. Retrieved August 28 from <http://db.grinnell.edu/sigcse/sigcse2013/Program/viewAcceptedProposal.pdf?sessionType=paper&sessionNumber=109>
- Kotobee. (2014). Create Multiplatform interactive ebooks with all the study tools your users need. Website. Retrieved March 31, 2015 from <http://www.kotobee.com/>
- Langer, M. (2012). *iBooks Author: Publishing Your First Ebook*. Flying M Productions, Inc., 2012, ISBN-10:188663707
- MacWilliam, A. (2013). *The Engaged Reader: A human-centered evaluation of ebook user experience*. Pub Res Q. Springer. DOI 10.1007/s12109-013-9305-8. Retrieved August 26, 2013 from <http://angusmacwilliam.co.uk/wp-content/uploads/2013/02/The-Engaged-Reader-Article-version.pdf>
- Nishat, N. (2013). *Design and Development of an Educational Interactive Ebook*. MSc Project Report.
- Prince, M. (2004). Does Active Learning Work: A Review of the Research. *Journal of Engineering Education*. 93 (3). P.223-231. Retrieved September 7, 2013 from [http://ctl.t.jhsph.edu/resources/views/content/files/150/Does\\_Active\\_Learning\\_Work.pdf](http://ctl.t.jhsph.edu/resources/views/content/files/150/Does_Active_Learning_Work.pdf)
- Princeton University. (2010). *The E-reader pilot at Princeton*. Retrieved August 27, 2013 from <http://www.princeton.edu/ereaderpilot/eReaderFinalReportLong.pdf>
- Roxburgh, S. (2012). The e-Future. *Horn Book Mag 2012 10–1*. Retrieved August 27, 2013 from <http://www.hbook.com/2012/04/creating-books/publishing/the-e-future/>
- Wilson, R. (2001). Evolution of portable electronic books. *Ariadne 2001*; (29), 2 October 2001. Retrieved August 27, 2013 from <http://www.ariadne.ac.uk/issue29/wilson>
- Wilson, T. D. (2014). The e-book phenomenon – a disruptive technology. Information Research, Vol 19, No.2. Retrieved March 31, 2015 from <http://www.informationr.net/ir/19-2/paper612.html#.VRqi8Y4bKIE>
- UNICEF. (1999). Explore ideas – articles, opinions and research about teaching and learning. Website. Retrieved March 31, 2015 from <http://www.unicef.org/teachers/teacher/styles.ht>

# Identifying the Conflicts in the Software Requirement Engineering: A Literature Review

<sup>1</sup>Umma Khatuna Jannat & <sup>2</sup>Md. Mijanur Rahman

<sup>1</sup>Daffodil International University, Dhaka Bangladesh, [jannat35-228@diu.edu.bd](mailto:jannat35-228@diu.edu.bd),  
Phone Number: +88001829261434

<sup>2</sup>Daffodil International University, Dhaka Bangladesh, [mmr.sinha@daffodilvarsity.edu.bd](mailto:mmr.sinha@daffodilvarsity.edu.bd),  
Phone Number: +88001911354201

**Abstract:** Conflicts generally arise through lack of misunderstandings and miscommunication that involves the interaction and collaboration of different individuals. This conflict arises with poor relationship and has created too many failures in software development. It increases the development cost and change of requirement. Even later the system is judged unsatisfactory and unacceptable to the user. Requirement elicitation is the important part of software engineering. Many problems associate with requirement engineering including understanding the different group of people affected by the development of the given system. In the software requirement engineering area, we must avoid conflict to collect good requirements. Because of conflict, it is tough to involve all possible stakeholder effectively. The requirement analysts are the most important part of the software development because requirement analysts has goal to collect a proper requirements and elicit from multiple stakeholders. Conflict with requirement analysts and requirement provider, it's creating a big problem. So client does not get quality full software without quality full requirement. This paper covers the generic conflicts during the requirement elicitation between requirement analysts and requirement providers. We also give brief idea to solve conflicts, how the conflict is occurred during the requirement elicitation and analysis of those factors.

**Keywords—** *requirement elicitation, stakeholder, requirement analyst, conflict of interest, requirement engineering*

## 1. Introduction

Requirements engineering is concern with identifying, modeling, communicating and documenting the requirements for a system and the contexts in which it will be used. Requirements engineering act like a bridge between client and software system. Requirements engineering is the most important area of software engineering it's create a foundation for any software. "The success of the requirements elicitation activity gives high impact on the achievement of the goals set for requirement engineering, which leads to the development of correct application. Hence, the development of any application is indispensable from incorporating good practices of requirements elicitation. In fact the consideration has an impact to the usability of the application" [1]. The success of software depends on how well it fits the needs of its users and its environment. Requirements engineers have numerous challenges to develop successful software. In this process there are number of difficulties but their main goal is to collect a quality full requirement However, sometimes they fail some sort of reason one of them is conflict. Robinson et al. "Describes three technical difficulties that lead to conflicts that are, voluminous requirements, changing requirements, analysts and complex requirement" [2]. Conflict with requirements analyst and client is a common problem. Various clients have different expectation and views. Sometimes clients do not understand what is the actual important of requirement. Requirement engineer understand that requirement is necessary but without proper requirement software can develop. Quality full software is impossible to create. "Some research has concluded that systems failure can be traced back to poor requirements elicitation in up to "90%" of large software projects" [3]. In different literature claims "many software projects have failed because they collect a poor requirements" [4].



In the literature, it is found that different conflicts have different objectives. The interest of different conflict, such as: Dependability, Interoperability, Usability, Performance, Adaptability, Reusability, and Cost & Schedule. Many requirements engineering techniques such as using tools, design methods, and process models for specifying, validating, and verifying requirements to achieving successful software requirements. "This project chose a fourth generation language to satisfy software affordability and timeliness objectives .However, the project failed due to performance scalability problems" [5].

In this paper, the research direction is identifying the conflicts in the software requirement engineering phase. During this research we were driven by the following research question:

- **RQ:** What are the conflicts faced by the requirement analyst?
- **Motivation:** To identify the conflicts in requirement engineering phase.

Section 1 of this paper contain basic introduction of requirements engineering, conflict, and requirements engineering some techniques according to literature review, what are the problems. Section 2 consists of related work which followed by the research methodology section in section 3. Section 4 is result. Section 5 is discussion and section 6 is consists of conclusion and future work.

## 2. Related Work

Several researchers have addressed to identify conflicts in requirement for selection of an appropriate research method in different categories. Conflict can create among requirement, time-intensive, human error. In literature review it has been a great challenge to deal with conflicting. For example: Yen presents a formal framework that facilitates the identification and the trade-off analysis of conflicting requirements [6]. Yen's describe a systematic approach for analyzing the tradeoffs between conflicting requirements using the techniques in decision science [7]. Present critical aspect of resolving conflicts among stakeholder requirements. In research they provide some guidelines such as alternative requirements that remove stakeholder conflicts and use some strategy for resolution. They use CORA (Conflict-Oriented Requirements Analysis) has requirements ontology and strategies for restructuring requirements transformations as a means to remove conflicts. Software projects have failed due to requirements conflicts. They find out the reason and the resolution they use Win Win system .on the other hand this paper use some tools and techniques for identifying and resolving conflicts [8] . KAOS detects conflict based on divergence, competition and obstruction interactions among goals [9]. Win Win tool can provides for tracking team development of requirements, conflict detection and resolution [10]. Assigning negatively or the limitations of these approaches are: (1) each concern must be allocated a different priority (2) conflict handling is based on one criterion, the priority and (3) trade-offs must be negotiated with stakeholders to resolve conflicts without offering them any systematic analysis technique or tool.

## 3. Methodology

Literature review helps to identify the current-state-of-art by reviewing literature. There are different types of literature review techniques are available. In this research, we adopt the guidelines from Kitchenham and Charters [11]. Two issues can be noticed: the first issue is that we collected conflict related inconsistency from empirical studies in [9]. The second issue is that although global studying of conflicts in requirement only two hundred papers by using and/or/not. These paper were searched in "requirement elicitation", "requirements analyst", "conflict", "requirement engineering", analyzes and evaluates both positive and negative values of conflict. By using those keywords we have make a search string, which later used in different peer-reviewed databases such as IEEE, ACM, Springer, Elsevier, Google scholar, and Scopus.

We applied inclusion and exclusion criteria proposed by the Kitchenham et al. in this study. After that, we have includes 187 studies in this study as major findings from literature. We have also used open coding technique to analyze the collected data's. Both researchers reviewed the findings from literature, which helped to mitigate the validity threats.

## 4. Result

In this section we find out conflict identification and solution from the literature review. In literature review conflict conducted into the major causes issues relating to schedules, priorities, technical issues, procedure, cost and personality [12] [13]. However, conflict over financial issues tend to dominate the majority of projects partly because clients want the best at the lowest cost and contractors always want to maximize profit if possible at the expense of client[14]. Literature review are supported by data received which placed the likelihood of followed Table I and Table II. From the LR we identified 21 conflicts and 20 solutions.

**Table 1: Identification conflict**

<b>Conflict Barriers</b>	<b>Description</b>	<b>References</b>
Communication distance	Lack of synchronous communication distance	[19]
Effect on Performance	Performance mainly depends on how effectively the conflict increase	[20]
Geographical Distance	Lack of team cohesiveness Work effort overhead Lack of Trust Limited face-to-face meeting	[21]
Goal-oriented conflicts	It can be associated with end results, performance specifications and criteria, Priorities and objectives.	[20]
Technical opinions	Disagreements over technical issues and technical trade-offs	[20]
Conflict over cost and budget	Conflict over cost estimates from support areas regarding work	[20]
Conflict over schedules	Disagreements about the timing, sequencing, and scheduling	[20]
Logical consistency rules	A set of logical consistency rules is built to compare different viewpoints	[22]
Usability	Conflict can create for usability	[22]
Personality conflict	Disagreements on interpersonal issues	[20]
Socio-Culture Distance	Language difference Information sharing Uncommon understanding in ways of working Lack of mutual	[21]
Unwillingness	Lack of or unwillingness to understand	[13][15] [16][17]
Compromising	No one want to compromise	[18]
Experience	Lack of experience	[12][13][14]
Forcing	Pushes one's viewpoint at the expense	[20]

**Table 2: Identification solutions**

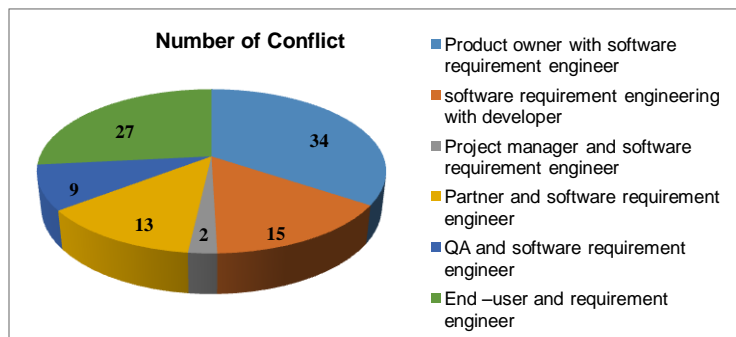
<b>Conflict Barriers</b>	<b>Solution</b>	<b>References</b>
Communication distance	Create a network can frequent travel	[13][14]
Effect on performance	Use groupware work	[12]

Geographical distance	Implement communication model frequent communication Use communication media To gain trust	[12] [14]
Goal-oriented conflicts	Use temporary solutions, Use backup option	[12]
Technical opinions	Use peer review and steering committees to review	[13]
Conflict over cost and budget	Develop overall budgets supported by detailed budget and cost estimates of tasks and activities	[13]
Conflict over schedules	Develop an overall schedule	[13]
Logical consistency rules	Generated to fix the logical inconsistencies arising	[22][21]
Usability	Support those items and formats that are available	[21]
Personality conflict	Create an environment that emphasizes respect, diversity, and equality.	[20]
Socio-Culture Distance	Use a common communication language Evaluate remote client capability	[21][19]
Unwillingness	Try to more communicate and understand.	[20]
Compromising	Searches for and bargains for solutions that bring some degree of satisfaction to all	[20]
Experience	Clarify roles, responsibilities	[20]
Forcing	Offers only win-lose situations	[20][21]

#### 4.1 Conflict with different stakeholders

In a project there is product owner, software requirement engineer, project manager, quality assurance, and end –user work. They may influence the project planning, design, implementation and future use and their main goal to create quality full software. So there is lots of important people work to fulfill their goal so that time conflict can occur. Software requirement engineer and their conflict are:

- I. Product owner with software requirement engineer.
- II. Software requirement engineer with developer.
- III. Project manager and software requirement engineer.
- IV. Partner and software requirement engineer.
- V. QA and software requirement engineer.
- VI. End –user and requirement engineer.



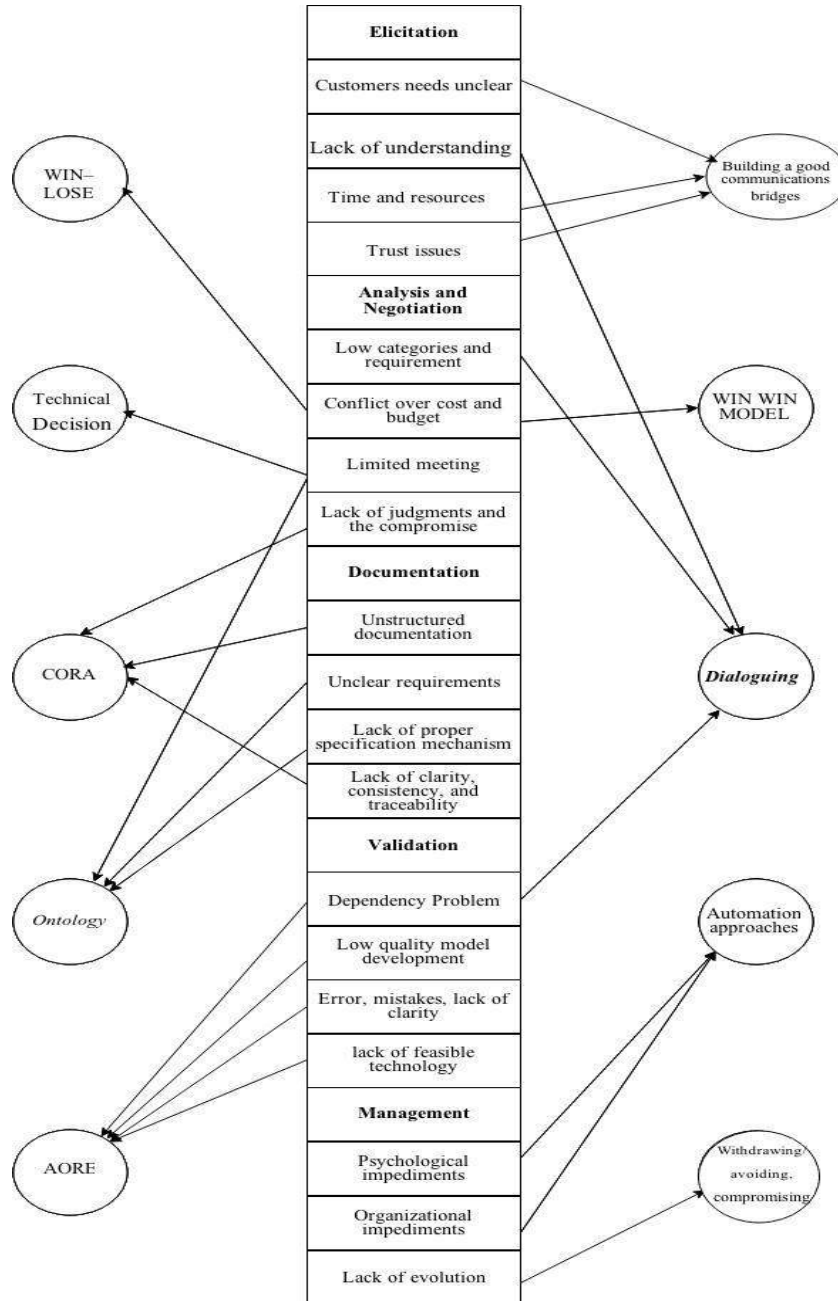
**Figure 1:** Number of conflict

## 5 Discussion

When we examine data collated from the literature review, we developed checklists that could be utilized in identifying conflict. They are followed in succession by clients, developer, project manager, and others. This means that on the minds of respondents, conflict in construction seems to be mainly fuelled by

contractors [23]. Even though the data in the checklists is categorized in a particular order, some of the conflict .For product owner, Project Managers, developer, QA, partner and end-user show all conflict in figure: 1. However, there are also some striking differences, which we discuss in this section.

### 5.1 Relationship between conflicts and solutions



**Figure 2:** A relation between conflicts and solutions

#### 5.1.1 Elicitation

Good RE process is therefore essential for successful system development [24].It is regarded as the first phase of the RE process and normally considered as the process of finding out ‘what are the real needs of the customers as well as of the system’ [25]. It also includes activities to explore ‘how the software can

meet the stakeholders' goals' and 'what alternatives might exist' [26]. Conflict can occur in RE elicitation to sometimes customer's needs unclear, lack of understanding, time and resources, trust issues those types of problem can occur. For resolving the conflict we can use technique like building a good communications bridges.

### **5.1.2 Analysis and Negotiation**

It is the second phase, which consists of a set of activities aimed to discover problems. If discovers some problems with over cost from support areas regarding work breakdown structures. Types of low categories and requirement, face to face limited meeting and lack of judgments and the compromise can create a problem. All the conflict requirements identified during the analysis process should be negotiated and discussed individually with the stakeholders in order to resolve the conflicts [25, 27]. Managing conflict using some sort of technique like Win Win Model, Win Lose Model, Technical Decision, Conflict-Oriented Requirements Restructuring, Ontology and Dialoguing. The win win model approach is aimed at addressing collaboration for the requirements engineer [28]. The three key ideas in the approach are: win win spiral process, win-win requirements model, win win negotiation model. Win lose model try to find new ways to reach their goals and at the same time meet the goals of the opponents. Technical decision develops a master plan compatible with long-term strategies and develops a work breakdown structure and a corresponding responsibility matrix. Conflict-Oriented Requirements Restructuring (CORA). CORA assumes a cycle among three phases: 1) System requirements are defined 2) Issues arise 3) Requirements are changed in response to the conflicts. Ontology definition is structure template for requirements. It is needed to formally define the requirements for the meeting. Lastly dialogue is based on the principle that people affected by decisions ought to have an effective participation in the decision-making process.

### **5.1.3 Documentation**

This is the third phase of RE process. Requirements have been analyzed in this process. It is important make them formal through proper specification mechanism. This steps deal with the find out unstructured documentation, unclear requirements, lack of proper specification mechanism, Lack of clarity, consistency, and traceability and solving those problem are occur conflict. Solving conflict can use such techniques ontology and CORA

### **5.1.4 Validation**

Validation is the fourth phase ensures that models and documentation accurately. Check the requirements document for conflicts, omissions and deviations from different standards. In this phase focus is on looking for Dependency Problem, Low quality model development, Error, mistakes, lack of clarity and lack of feasible technology find out these and solutions using aspect-oriented requirements engineering (AORE) may lead to conflicting situations that have to be analyzed and resolved.

### **5.1.5 Management**

This is the fifth and last phase of requirements lifecycle. It is maintenance of a software system. Some of tasks during Psychological impediments, Organizational impediments, Lack of evolution. Management conflict resolution techniques focus on the Automation approaches and Withdrawing/avoiding, compromising. Automation approaches for conflict analysis that uses tools to analyze requirements consistency in order to reduce. Conflict occur lack of Withdrawing/avoiding, compromising Retreats from an actual or potential conflict situation and Searches for and bargains for.

## **6 Conclusion and Future Work**

**6.1 Summary:** Planning and executing a construction project usually requires inputs and interaction project team. Even though conflict amongst software requirement engineer in the industry is not new,

particular emphasis has been placed on conflict management in recent times such as by the Latham report which portrayed conflict as a damaging phenomenon that needs to be reduced and possibly eliminated from the construction process [29][30][31]. Conflicts can occur over schedules, priorities, technical issues and even over personality. Hence, the study sought to identify the major causes of conflict to analyses the conflict resolution approaches.

**6.2 Contributions:** Through a literature review we have identified 21 conflicts and 20 solutions.

**6.3 Future work:** In the future work our emphasis will be to survey in a company and collect data in context of Bangladesh.

## References

- [1] Kasirun, Zarinah Mohd. "A Survey on Requirements Elicitation Practices Among Courseware Developers." *Malaysian Journal of Computer Science* 18.1 (1970). pp. 70-77.
- [2] WNRobinson, dPSuzanne, V Vecheslav, (2003). *RequirementsInteraction Management*. ACM Comput. Surv., 35(2): 132–190.
- [3]Sean Isserman,Challenges of Requirements Elicitation.
- [4] Easterbrook,,S (1994). *Resolving Requirements Conflicts withComputer-Supported Negotiation*, Academic Press, RequirementsEng., pp. 41-65.
- [5] InBoehm-, 1996 ,CONFLICT IDENTIFICATION AND RESOLUTIONFOR SOFTWARE ATTRIBUTE REQUIREMENTS
- [6] JYen,W. ATiao, "A Systematic Trade-off Analysis for Conflicting Imprecise Requirements", 3rd IEEE International Symposium on RE (1997), pp-168
- [7] William N. Robinson and Vecheslav Volkov, 1999. *Requirement Conflict Restructuring*
- [8]In, Hoh. CONFLICT IDENTIFICATION AND RESOLUTION. Diss. University of Southern California, 1998.
- [9] Robinson, William N., Suzanne D. Pawlowski, and Vecheslav Volkov. "Requirements interaction management." *ACM Computing Surveys (CSUR)*35.2 (2003): 132-190.
- [10] B. Boehm, In, H., *Identifying Quality-Requirement Conflicts*, IEEE, Software, March, 1996, pp.25-36.
- [11] Kitchenham, 2007. *Guidelines for performing Systematic Literature Reviews in Software Engineering*
- [12] B. Graham, "Managing Conflict, Persuasion and Negotiation," *People in Project Management*, Gower publishing, 2003.
- [13] Leung, Mei-Yung, S. Thomas Ng, and Sai-On Cheung. "Measuring construction project participant satisfaction." *Construction Management and Economics*22.3 (2004): 319-331.
- [14] G. D. Wood and R. C. T. Ellis, "Main Contractor Experiences of Partnering Relationships on UK Construction Projects," *Construction Management and Economics*, pp. 317-325, 2005.
- [15] Khattab, Mostafa M., and Ketil Søyland. "Limited-resource allocation in construction projects." *Computers & industrial engineering* 31.1 (1996): 229-232.
- [16] K. T. W. Yiu and S. O. Cheung, "A Catastrophe Model of Construction Conflict Behaviour," *Building and Environment*, pp. 438-447, 2005.
- [17] K. N. Jha and K. C. Iyer, "Critical Factors Affecting Quality Performance in Construction Projects," *Total Quality Management*, pp. 1155-1170., 2006.
- [18] *An Analysis of Soft Conflict Resolution Approaches in the UK Construction Industry*, 2012.
- [19] Moura, Helder M. Pinto, and José M. Cardoso Teixeira. "Managing stakeholders conflicts." (2010).
- [20] Verma, Vijay K. "Conflict management." *The Project Management Institute Project Management Handbook*, Ed Jeffrey Pinto (1998)..
- [21] Indira Nurdiani, Ronald Jabangwe, Darja ~Smite, Daniela Damian,2011. *Risk Identification and Risk Mitigation Instruments for Global Software Development: Systematic Review and Survey Results*.
- [22] *Requirements Conflict*, 1995.
- [23] J. R. Meredith and S. J. J. Mantel, *Project Management, A Managerial Approach*, John Wiley & Sons (Asia) Pte Ltd., 2006, Sixth Edition.
- [24] Mead, N. 1996. *Security Requirements Engineering*. Carnegie Mellon University. Last Retrieved March 20, 2008. <https://buildsecurityin.us-cert.gov/daisy/bsi/ articles/bestpractices/requirements/243.html>

- [25] Kotonya, G. and Sommerville I. 1998. Requirements Engineering Processes and Techniques, John Wiley & Sons Ltd, England
- [26] Hofmann, Hubert F., and Franz Lehner. "Requirements engineering as a success factor in software projects." *IEEE software* 18.4 (2001): 58-66.
- [27] Paetsch, F., Eberlein, A. and Maurer, F. 2003. Requirements Engineering and Agile Software Development. *Enabling Technologies*, IEEE. pp. 308-313.
- [28] B. Boehm, In, H., Identifying Quality-Requirement Conflicts, *IEEE, Software*, March, 1996, pp.25-36.
- [29] Gardiner, Paul D. *Project management: a strategic planning approach*. Basingstoke: Palgrave Macmillan, 2005.
- [30] M. Latham, "Constructing the team," HMSO Publications Centre, Crown copyright, London, 1994.
- [31] Loosemore, M. Nguyen, and B. NGUYEN. "BT and Denis, N.(2000)'An investigation into the merits of encouraging conflict in the construction industry'." *Construction Management and Economics* 18: 447-456.

# Suomi National Polar-orbiting Partnership Satellite Data Processing System to Produce Vegetation Indices

Budhi Gustiandi

Remote Sensing Technology and Data Center – National Institute of Aeronautics and Space (LAPAN)  
Jl. LAPAN No. 70, Pekayon, Pasar Rebo, Jakarta Timur 13710, Indonesia  
budhi.gustiandi@lapan.go.id, (+62) 21 8710786

## Abstract.

A Suomi National Polar-orbiting Partnership (NPP) satellite data processing system has been built to produce vegetation indices. The system integrated open source based operating system (Linux CentOS) and application softwares (Real-Time Software Telemetry Processing System / RT-STPS, Community Satellite Processing Package Science Data Record / CSPP SDR, and CSPP Environmental Data Record / CSPP EDR) into a single server computer. Integration was done by using bash shell scripting language. The vegetation indices that are produced by the system are described in detail. Empirical method of evaluation technique with sampling approach is utilized to assess the system performance. Two main considerations are size of data and processing speed. The evaluation results show that the server computer needs a minimum storage capacity of 32.65 TB to accommodate Suomi NPP satellite data from rawdata level to vegetation indices storage requirement until the satellite's predicted mission life will be over. The system also has potential to be developed as a near real time system in the future, but it has to be monitored intensively because there were processing times that were longer than the fastest interval time between two consecutive satellite's data acquisition times (1 hour 35 minutes).

**Keywords:** CSPP, empirical method, processing system, remote sensing, RT-STPS, satellite, sampling approach, suomi NPP, vegetation indices.

## 1 Introduction

South East Asia has long shorelines, its population and economic activities mainly concentrate in coastal areas, and highly dependent to agriculture and forestry, so that it becomes as one of the world regions which is very vulnerable to the climate change. Increasing frequency and intensity of extreme weather events, such as heat wave, drought, flood, and tropical cyclone in the last few decades shows that climate change has afflicted this region. World ocean surface is predicted to increase of about 70 centimeters in the year of 2100. Average annual temperature in three countries (Indonesia, Thailand, and Vietnam) is predicted to increase in the mean of 4.8 °C in the same period compared with their average temperature in the 1990s and is projected to experience drier weather in the two to three decades in the future. This climate change will result disadvantages that have to be beared by the South East Asia with estimation of two-fold of global average loss (ADB, 2009).

Land use, land-use change, and forestry (LULUCF) activities which are mostly (up to three quarter) consist of forest deforestation and degradation that do not well managed, are main source as well as active contributor to greenhouse gases or carbon emission that related to the climate change and global warming. Deforestation related to decreasing in forest area, and degradation related to decreasing in forest quality. Although the existence of LULUCF can not be avoided in a country (Mather, 1992), but currently LULUCF contibutes total carbon emission in the world that is higher than the emission from fossil fuel usage in global transportation sector (Stern, 2006). As an illustration, approximately 1.6 billion tons of carbon are emitted every year and 13 million hectares of forest are dissapeared because of the LULUCF (Denman et al., 2007).

The forest capability to absorb carbon is reducing caused by decreasing area and quality of the forest itself. CO<sub>2</sub> absorption by each trees makes forest hold the key position in climate change and global warming mitigation efforts. Forest resources have limited capability so that they must be controlled wisely, well planned, and sustainable. The world can not ignore the forest deforestation and degradation impacts to the climate change and global warming (Angelsen & Atmadja, 2010).



Indonesia is one of the countries that have largest tropical forest in the world so that it become as an important country that can reduce emission through carbon absorption by forest. Indonesia has positioned itself in international level emission reduction negotiation effort with its strongly commitment to actively role in emission reduction of 26 – 41 % in 2020. Increasingly widespread forest area conversion to become oil palm plantations, especially in Sumatera and Kalimantan islands (Purwadhi and Haryani, 2006), require a tool that can quickly produce spatial information to monitor and inventarise forest condition in Indonesia that is measurable, reportable, and verifiable (MRV).

Three of the ninety nine developing countries in the tropical region have had very good capability in implementing system that meet the MRV criteria. Karousakis (2007) studied two of them (Costa Rica and Mexico) in depth. Most of the other countries only monitor forest areas that have commercial purpose (De Fries et al., 2006). Truthfully, national policy formulation and development that is more appropriate and related with the problems in the real world will be succeed with availability of well structured MRV (Barr, 2001; Spek, 2006).

One of the key point in implementing efective and efisien measurement and monitoring is by utilizing remote sensing data which is supported by in situ measurement, particularly in countries who have very large forest area (DeFries et al., 2007). Remote sensing is more suggested by using satellite platform than aerial platform because it has advantage in speed and easier availability as well as larger area scope (Jaya, 1997). Several remote sensing satellite applications that have been implemented to support forest resources monitoring are biomass measurement (Sutanto, 1986; Januardi, 1998), land cover determination (Sumaryono, 1999; Dewanti, Agus, and Susanna, 1999; Kurniawan, 2000; Gantini et al., 2010), stands density level determination (Harsanugraha et al., 1999), land cover change monitoring (Purwadhi & Haryani, 2006; Hansen et al., 2008), and forest plant phenology monitoring (Kross et al., 2011).

Remote sensing data that are mostly utilized as main component in forest monitoring activities are vegetation indices (VI). Vegetation indices have not only qualitative applications but also quantitative applications (GSFC, 2014). Qualitatively, they provide a means of separating vegetation from other surface types, and they also give a general indication of the “greenness” which is a combined measure of the type, density, and health of vegetation present within a given region. Quantitatively, the changes in vegetation indices can be analyzed both seasonally and in the longer term by adjusting for bidirectional reflectance and atmospheric effects if their retrievals are made consistently. Real world quantities such as Leaf Area Index (LAI) and chlorophyll absorption also can be estimated from regression products of vegetation indices.

VI have been used with other statistical data to support rubber tree area growth in the mainland of South East Asia (Li & Fox, 2012). Vegetation change assessment in urban area also has been done regarding to VI (Schumacher et al., 2009; Fousenni et al., 2011). Moreover, VI have been utilized to map land cover in very large ecological area in regional scale (including some countries in Southern America) (Clark et al., 2010). Furthermore, VI have been used to monitor land cover in global scale (Fritz et al., 2012).

Back to more than a decade ago, National Aeronautics and Space Administration (NASA) has launched a group of satellites that present an unmatched appearance of Earth from space (Salomonson et al., 2006). That group is as known as NASA’s Earth Observing System (EOS), has supplied extraordinary recent awareness into many dynamics of Earth, including its clouds, oceans, vegetation, ice, and atmosphere. On the other hand, a next generation of Earth-observing satellite has been prepared to substitute as the EOS satellites lifetime will be over.

A critical first step in building this next-generation satellite system is represented by National Polar-orbiting Operational Environmental Satellite System (NPOESS) Preparatory Project (NPP) (Murphy, 2006). This is a first satellite of the next-generation satellite system that is used to observe more aspects of Earth’s dynamic. It is designed mainly to retrieve important data that are required to develop understanding, monitoring, and predicting the trend of long-term climate change and short-term weather fluctuations.

To respect of a former University of Wisconsin’s meteorologist who is known widely as “the father of meteorology satellite”, Verner E. Suomi, NPP satellite has been renamed by NASA. The

announcement was decreed at the annual conference of the American Meteorological Society in New Orleans in Januari 24<sup>th</sup>, 2012 (AMS, 2012). It has been renamed as Suomi National Polar-orbiting Partnership or Suomi NPP.

Suomi NPP satellite collects and distributes land, ocean, and atmosphere remote sensing data to its users as responsibility of measurements continuity that are required to bridge current NASA EOS (Terra, Aqua, and Aura satellites) missions and future low-Earth orbiting weather and environmental observation satellite systems (Joint Polar Satellite System / JPSS – formerly named NPOESS, a joint program between National Oceanic and Atmospheric Administration / NOAA and NASA Goddard Space Flight Center / GSFC, which its first launch is slated in 2017) (Xiong et al., 2012). The satellite provides atmosphere and sea surface temperature, humidity, land and ocean biology productivity, including cloud and aerosol properties data.

Suomi NPP satellite orbits the Earth about 14 times a day and monitors the planet's surface nearly as a whole. The satellite was launched toward orbit on October 28<sup>th</sup>, 2011 at 5:48 a.m. Eastern Daylight Time by using United Launch Alliance Delta II rocket from Vandenberg Air Force Base in California. It was predicted to have a 7-year design life with 5-year mission life (GSFC, 2015a, Spacecraft and Instruments section).

Suomi NPP satellite brings a diverse payload of scientific instruments for Earth surface observation purpose. It has weight about 4,600 pound (2,100 kilograms), overpass the equator each afternoon at around 1:30 p.m. local time. The key instruments are as follows:

- Visible Infrared Imager Radiometer Suite (VIIRS) – a 22-band radiometer builded by Raytheon Space and Airborne System that is very much like with the Moderate Resolution Imaging Spectroradiometer (MODIS) heritage instruments on Terra and Aqua satellites (Schueler & Barnes, 1998; Ardanuy et al., 2001; Murphy et al., 2001; Schueler et al., 2001; Murphy, 2006). VIIRS obtains Earth's dynamic surface processes, such as land changes, wildfires, and ice movement through its infrared and visible appearances. Oceanic and atmospheric profiles, including sea surface temperature and clouds, also be quantified (Murphy et al., 2006);
- Advanced Technology Microwave Sounder (ATMS) – a 22-band passive microwave radiometer that is used to develop global models of humidity and temperature properties which are required by meteorologists to model weather prediction (Goldberg & Weng, 2006);
- Cross-track Infrared Sounder (CrIS) – an interferometer that is used to monitor atmosphere properties, such as pressure and humidity to develop enhancements in both long- and short-term weather prediction (Susskind, 2006);
- Ozone Mapping and Profiler Suite (OMPS) – an innovative nadir-looking and a very advanced limb-looking pairs hyperspectral imaging spectrometer sensor developed by Ball Aerospace. The instrument is used to measure Earth's ozone layers, particularly around the poles where the layers very fluctuative (Flynn et al., 2006); and
- Clouds and the Earth's Radiant Energy System (CERES) – a 3-band radiometer that is used to quantify returned solar radiation, diffused radiation from the Earth, and complete radiation in order to observe human activities and natural effects on the Earth's complete thermal radiation measurement (GSFC, 2011).

All of the instruments above were adopting NASA's EOS, NOAA's Polar Operational Environmental Satellite (POES), and Department of Defense's (DoD) Defense Meteorological Satellite Program (DMSP) instruments.

It has been more than a decade Indonesian National Institute of Aeronautics and Space (LAPAN) also consistently monitoring vegetation indices using remote sensing satellite data in Indonesia. In the national level, most of the vegetation indices data are acquired by processing Terra and Aqua satellites MODIS instruments data (Gustiandi et al., 2012). As Suomi NPP satellite has been launched, Indonesia also makes several efforts to ensure data availability from this satellite to complement the existing data from Terra and Aqua satellites.

Indonesian National Institute of Aeronautics and Space (LAPAN) remote sensing ground station in Parepare, South Sulawesi, has received Suomi NPP satellite data in Direct Broadcast (DB) mode since May 2012. Signals from the satellites are captured by the antenna and converted by the acquisition server computer into rawdata level data. The data then are sent to the Remote Sensing Data Center (RSDC) in Pekayon, East Jakarta through a Virtual Private Network (VPN) with bandwidth of 30 Mbps. They have to be processed into higher levels data, such as Raw Data Record

(RDR), Sensor Data Record (SDR), Intermediate Product (IP), Application Related Product (ARP), Environmental Data Record (EDR), and Climate Data Record (CDR) so that the data are ready to be utilized by the end users. VI themselves are one of the EDR level data that are processed from VIIRS instrument data.

The rawdata level data to RDR level data processing system has been built in the previous activity (Gustiandi, Indradjad, & Bagdja, 2013). Then, the system was developed so that it can produce SDR level data from RDR level data (Gustiandi and Indradjad, 2013). Although the system is physically located remote from the ground station, but it behaves as an integrated system with the ground station.

However, the processing system that can produce VI from their corresponding SDR level data was not available yet int LAPAN's remote sensing ground station. Hence, we developed the system further so that it can produce VI products by adopting previous system and integrating it to the ground station seamlessly.

## 2 System Description, Data, and Evaluation Method

### 2.1 System Description

A server computer, a Network Attached Storage (NAS), and communication networks with the specifications listed in Table 1 were used to develop the system. The server computer is located in RSDC in Jakarta. As previously stated, it is connected with the acquisition system in Parepare through a VPN with a bandwidth of 30 Mbps. Besides the VPN, there is also a separated internet network to connect the server computer with National Oceanic and Atmospheric Administration (NOAA) servers for downloading ancillary data that are required in some processing steps. The NAS was configured in RAID 5 + 1 mode, hence the storage capacity of the NAS is become only 20 TB.

**Table 1** Computer server and communication networks specifications used to develop Suomi NPP data processing system to produce vegetation indices.

<b>Server Computer</b>			
Processor	24 core @ 2.4 GHz		
Memory	64 GB		
Storage Capacity	4 TB		
<b>Network Attached Storage (NAS)</b>			
Storage Capacity	24 TB		
<b>Communication Networks</b>			
Virtual (VPN)	Private	Network	30 Mbps
Internet	40 Mbps (shared with office communication network)		

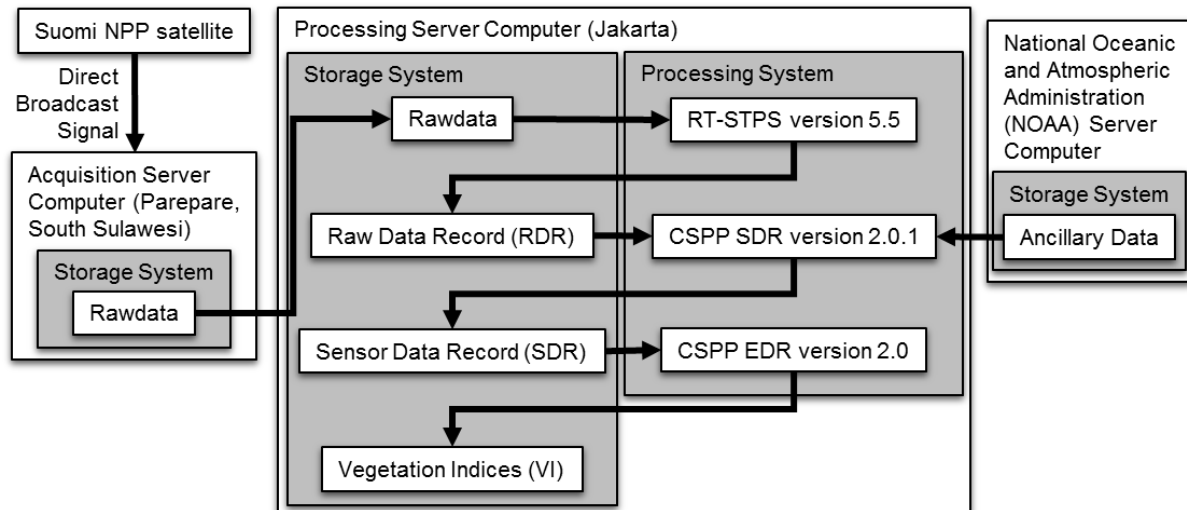
The system was designed so that it can be implemented in other server computers without be constrained by the license. Hence all the operating system and the softwares that have been used in the developed system are open source based.

The server computer used Linux CentOS version 6.3 (<http://www.centos.org>) as the operating system. Although currently there is a newer version of Linux CentOS (version 7) that has been released officially by its developer, but it has not been tested in the previous Suomi NPP remote sensing satellite data processing system that has been built. Hence, the server computer was maintained to use the version 6.3.

Softwares that were used in the developed system were Real-Time Software Telemetry Processing System (RT-STPS) version 5.5 (<http://directreadout.sci.nasa.gov>), Community Satellite Processing Package (CSPP) Science Data Record (SDR) version 2.0.1 (<http://cimss.ssec.wisc.edu>), and CSPP Environmental Data Record (EDR) version 2.0 (<http://cimss.ssec.wisc.edu>). RT-STPS software is maintained and developed by National Aeronautics and Space Administration (NASA) Goddard Space Flight Center (GSFC) Direct Readout Laboratory (DRL). The RT-STPS software itself recently is available in version 5.6. But, because the installation and user manual of CSPP SDR (CIMSS,

2014) states that the software only compatible with RT-STPS version 5.5, hence we keep on using RT-STPS version 5.5 in developing the system. Whereas both CSPP SDR and EDR softwares are maintained and developed by University of Wisconsin Space Science and Engineering Center (SSEC) Cooperative Institute for Meteorological Satellite Studies (CIMSS) to support the DB meteorological and environmental satellite communities.

Traditionally, architecture of a system or software integration can be explained by a flowchart. The flowchart has purpose to describe the computation domain (components or sub systems) and communication domain (connectors) that construct the system as a whole (Bass, Clements, & Kazman, 2003). Figure 1 shows a flowchart of Suomi NPP remote sensing satellite data processing system to produce vegetation indices that has been developed.



**Figure 1** Suomi NPP remote sensing data processing system to produce vegetation indices that has been developed.

First, LAPAN remote sensing ground station acquires Suomi NPP satellite signals in direct broadcast mode. Then the signals are converted by ingesting system to become rawdata level data and stored in acquisition storage system. Later, these rawdata are copied from the acquisition storage system in Parepare to the developed processing storage system in Jakarta through VPN. RT-STPS software then is used to create native binary format EOS-compliant in Raw Data Record (RDR) level data from the rawdata level data. The conversion process includes frame synchronizing, Pseudo-Noise (PN) decoding, Reed-Solomon (RS) decoding, time ordering, and separating instrument data streams into independent files as well as writing to socket for real-time data relay. In this stage, the developed system produces 4 (four) RDR level data, each of them are VIIRS RDR, ATMS RDR, CrIS RDR, and OMPS RDR. The RDR level data from the CERES instrument, however, have not been produced yet by the current version of RT-STPS that is used in the developed system. All of the RDR level data then are saved back into processing storage system.

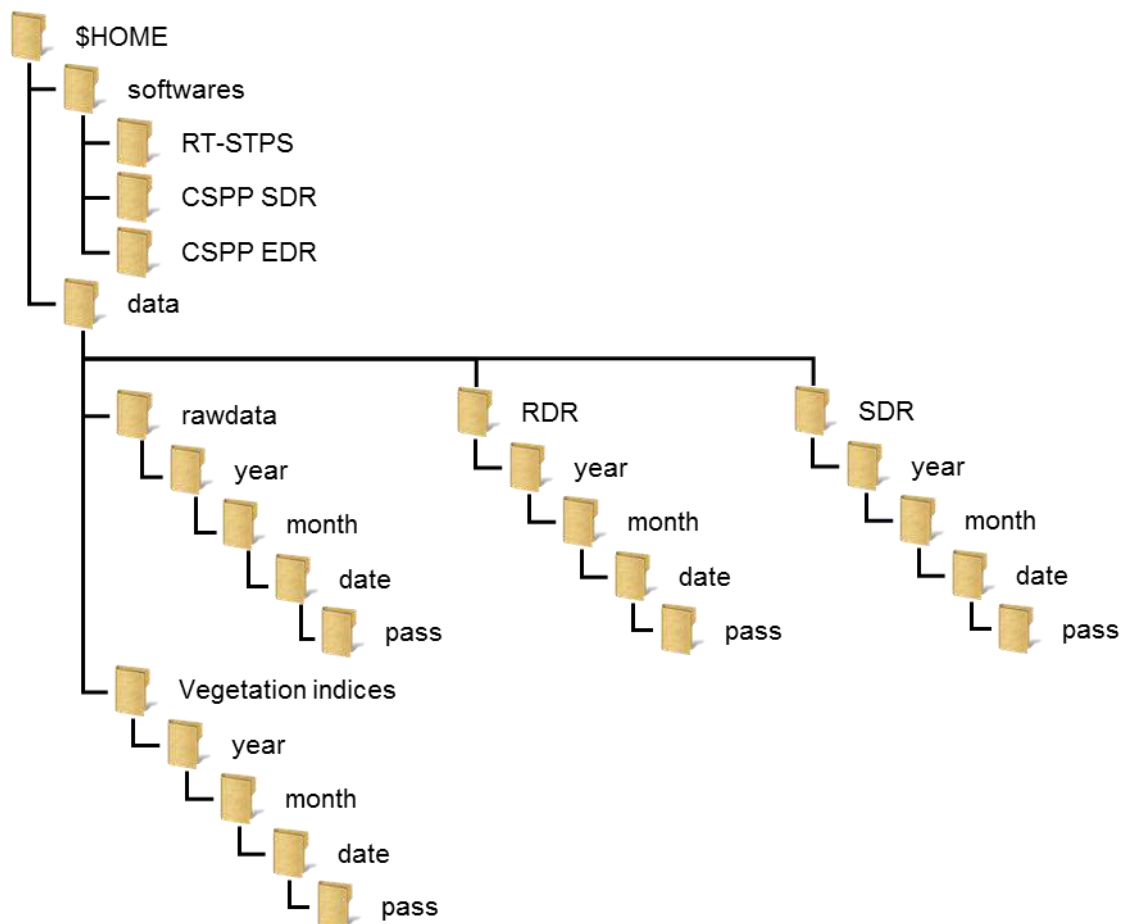
Afterwards, VIIRS instrumen RDR level data are processed into Sensor Data Record (SDR) level data by using CSPP SDR software. Note that RDR level data from other instruments are not processed further because vegetation indices only require VIIRS instrument data. SDR level data are full resolution instrument data that are time marked, geolocated, and calibrated by applying the ancillary information (downloaded automatically from NOAA's server computers at runtime), including radiometric and geometric calibration coefficients and Earth-referencing parameters such as satellite attitude. Ancillary data not only includes coefficients and parameters that are required to process RDR level data into SDR level data, but also coefficients and parameters that are required to transform back SDR level data into corresponding RDR data. The resulted SDR level data then are also saved back into processing storage system.

Last, CSPP EDR software was used to process VIIRS instrument SDR level data into vegetation indices. The processing step requires a number of static and dynamic ancillary data. The software first diagnoses the VIIRS instrument SDR level data based on date and time to compare with the mandatory ancillary data. It then will search the ancillary data internally, and if they are not exist, the

software will download the mandatory ancillary data from the SSEC servers. Although they are different than the ancillary data from the NOAA's server, the mandatory ancillary data will have the similar structure. All VIIRS instrument SDR level data are required to be located in the same directory. Vegetation indices that are produced as the output of the developed processing system then are saved back into processing storage system.

All the softwares that are used in the developed system were available separately. They were integrated by using bash shell scripting language into one integrated processing system. The main consideration to use this language is because the language has been known widely as the most comprehensive scripting language to work within Linux environment (Michael, 2008; Parker, 2011; Shoots Jr., 2012) that is used as the operating system. Moreover, all of the softwares that are used in the developed system are mostly have been built by using bash shell scripting.

The system directory structure was designed to have separately directories for softwares installation, processing steps, and processing results storage. The directories for each processing steps were made separately because each processing steps require that there must no data exist in the directory before they can begin processing the data. Furthermore, the directories structure for the data storage requirement were separated based on their processing level and acquisition datetime to facilitate easier data search in the future. The simplified directories structure for the developed system is illustrated in Figure 2.



**Figure 2** Simplified directories structure for Suomi NPP remote sensing satellite data processing system to produce vegetation indices.

## 2.2 Data

There are 2 (two) kinds of data that were used in developing the system. First, sample data in rawdata, RDR, SDR levels that accompanied RT-STPS, CSPP SDR, and CSPP EDR softwares. These data were used to validate the installation progress for each of the softwares. These data also

were used to validate the integrated developed system to ensure that there is no mistake both in processing flow and output data for each processing steps. Second, Suomi NPP remote sensing satellite “real” data in rawdata level that were acquired in direct broadcast mode by LAPAN remote sensing ground station. These data were used to validate conformity of the developed system not only for sample data but also for real data.

### **2.3 Evaluation Method**

All of the hardwares that were used in the developed system have fulfilled the minimum specifications that are required as stated in operating system and each of the integrated softwares installation technical document. But, the main consideration must be taken to the storage system. The capacity of the storage system is limited so that it can contribute to one of the key system quality attributes, maintainability (Pahl et al., 2009). Maintainability can determine whether a system is useful or not. Hence, it is important to know whether the existing storage system can accommodate Suomi NPP remote sensing satellite data in rawdata level and their associated resulted SDR level and vegetation indices data.

The storage requirement can be determined by using one of the three kinds of evaluation methods or techniques that are existed, as follows: empirical method, simulation technique, and analysis modeling (Lilja, 2000). Empirical method is done through metric calculation or measurement activities. Simulation technique is done by using artificial behaviour of a program execution. Analysis modeling is done via explanation in mathematical way about the running program. From the three methods or techniques, the empirical method gives the most accurate result because it directly connects with the actual data and do not use assumptions as many as the other method or technique. Therefore, the storage system requirement was evaluated by using empirical method.

Empirical method itself can be done by using 2 (two) kinds of approach, namely sampling and event tracing. Sampling approach is done by taking some processing results or output data after the system runs several times. One of the benefits of this approach is evaluation implementation can be done without stopping the running system first. In the other hand, event tracing approach is done by inserting tracing code into the programs that formed the developed system. Before the evaluation can be implemented, the running system must be stopped first, the tracing code must be inserted, and then the stopping system is run back again. Evaluation implementation by using event tracing approach will require more system resource such as memory be compared with sampling approach (Lilja, 2000). Hence, the evaluation implementation of storage system requirement was evaluated by using empirical method with sampling approach.

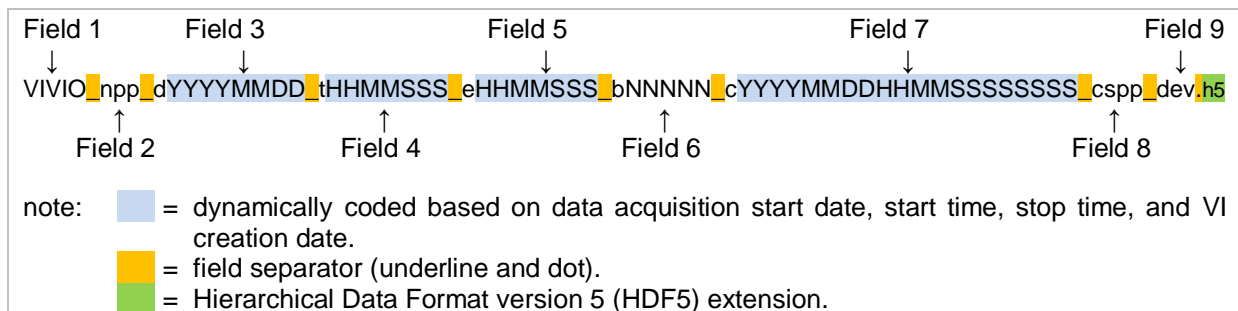
Sample data that were used in evaluation implementation were 688 data in rawdata level and their corresponding SDR level data as well as vegetation indices data. The acquisition times were from June 27<sup>th</sup>, 2014 to February 25<sup>th</sup>, 2015. Actually there were more than 688 data in rawdata level and their corresponding SDR level data. But, there were only 688 vegetation indices data that have been produced in the period of question. It was because not all rawdata level data were successfully processed into SDR level data or not all SDR level data were successfully processed into vegetation indices data. Several factors can influence this, such as too little scanned area or incomplete SDR level data. Evaluation was implemented by measuring smallest, biggest, and average size of resulted vegetation indices data.

Besides size of resulted data, evaluation was also implemented to processing speed so that it can be known whether the developed system has potential to be developed further in the future by implementing automation method in order to make the system as the near real time system.

## **3 Results and Discussion**

A graphical illustration of file-naming convention for VI that are produced by the developed system is depicted in Figure 3. The file-naming convention follows standards that have been determined in GSFC’s technical document (GSFC, 2015b). The first field (VIVIO) is named Data Product ID that indicates this data is a VI data. The second field (npp) is named Spacecraft ID that indicates this data was produced from Suomi NPP remote sensing data processing. It is coded npp, not snpp or suominpp because as was stated in the previous section, Suomi NPP was named NPP. It has been

renamed Suomi NPP in January 24th, 2012 (AMS, 2012), but the last revised file-naming conventions was determined in December 8th, 2009 (GSFC, 2012). The third field (dYYYYMMDD) is named Data Start Date and it is dynamically coded identified by a “d” letter followed by year, month, and day based on acquisition date of the earliest granule in the data. The fourth field (tHHMMSSSS) is named Data Start Time and it is dynamically coded identified by a “t” letter followed by hour, minute, sec, and tenths of seconds (in UTC) based on acquisition start time of the earliest granule in the data. The fifth field (eHHMMSSSS) is named Data Stop Time and it is dynamically coded identified by a “e” letter followed by hour, minute, second, and tenths of seconds (in UTC) based on acquisition end time of the latest granule in the data. The sixth field (bNNNNN) is named Orbit Number and it is dynamically coded based on the orbit number when the time of acquisition occurred. The seventh field (cYYYYMMDDHHMMSSSSSSSSSS) is named Creation Date and it is dynamically coded identified by a “c” letter followed by year, month, day, hour, minute, second, and microseconds (in UTC) based on creation time of VI data. The eighth field (cspp) is named Origin that indicates this data is produced by using CSPP software (in this case, CSPP EDR). The ninth or last field (dev) is named Domain Description. Actually, this field is recognized only for domain values of JPSS in the future.



**Figure 3** Graphical illustration of file-naming convention for VI data that are produced by the developed Suomi NPP remote sensing satellite data processing system.

The “h5” suffix in the end of the file-naming convention indicates the file is in Hierarchical Data Format (HDF) version 5 (HDF5) that is compatible with the JPSS Common Data Format Control Book (CDFCBs) (GSFC, 2012). The HDF5 data format is a standardized data format that is used to store Suomi NPP remote sensing satellite data and its derived data both in rawdata, RDR, SDR, IP, ARP, and EDR level (including VI data). This data format is development of HDF data format version 4 that has been used as standard data format to store Terra and Aqua remote sensing satellite data and its derived data. (The HDF Group, 2013).

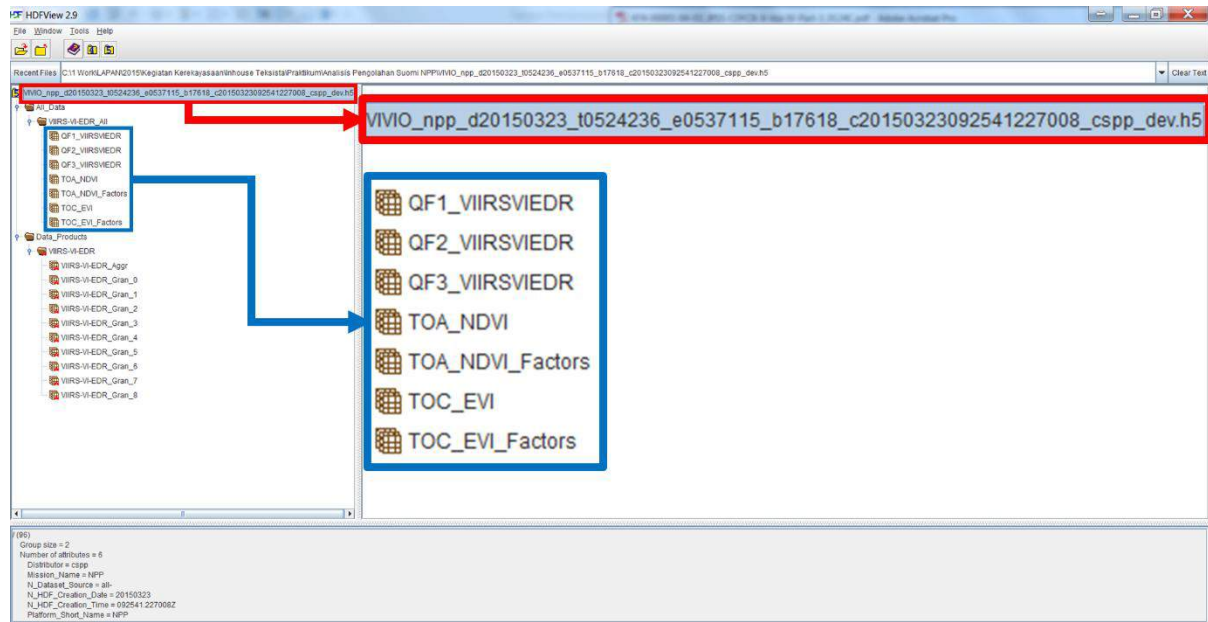
Data with HDF5 data format can be read by using various softwares, but the most native softwares that can be used to examine the contents of an HDF5 file are h5dump and HDFView that are available freely. Both of them are maintained and developed by the official developer of HDF data format, The HDF Group (<http://www.hdfgroup.org>), who is responsible to ensure the sustainable development of HDF technologies and the ongoing accessibility of HDF-stored data. h5dump can be accessed through command line that usually is used to dump the HDF5 file contents to an ASCII file. Whereas, HDFView can be accessed through a Graphical User Interface (GUI) in a visual manner for browsing and editing the HDF5 files.

One example of the reading vegetation indices data by using HDFView software is illustrated in Figure 4. From the file name that is shown by the red box, it is known that this is a vegetation indices file that is acquired in March 23th, 2015 from 05:24:23 UTC to 05:37:11 UTC (in 13 minutes and 48 seconds acquisition time) with an orbit number 17618. The vegetation indices file was created in the same day at 09:25:41 UTC by using CSPP EDR software. One vegetation indices data contains several sub data. The key sub data is shown by the blue box in Figure 4. They are QF1\_VIIRSVIEDR, QF2\_VIIRSVIEDR, QF3\_VIIRSVIEDR, TOA\_NDVI, TOA\_NDVI\_Factors, TOC\_EVI, and TOC\_EVI\_Factors.

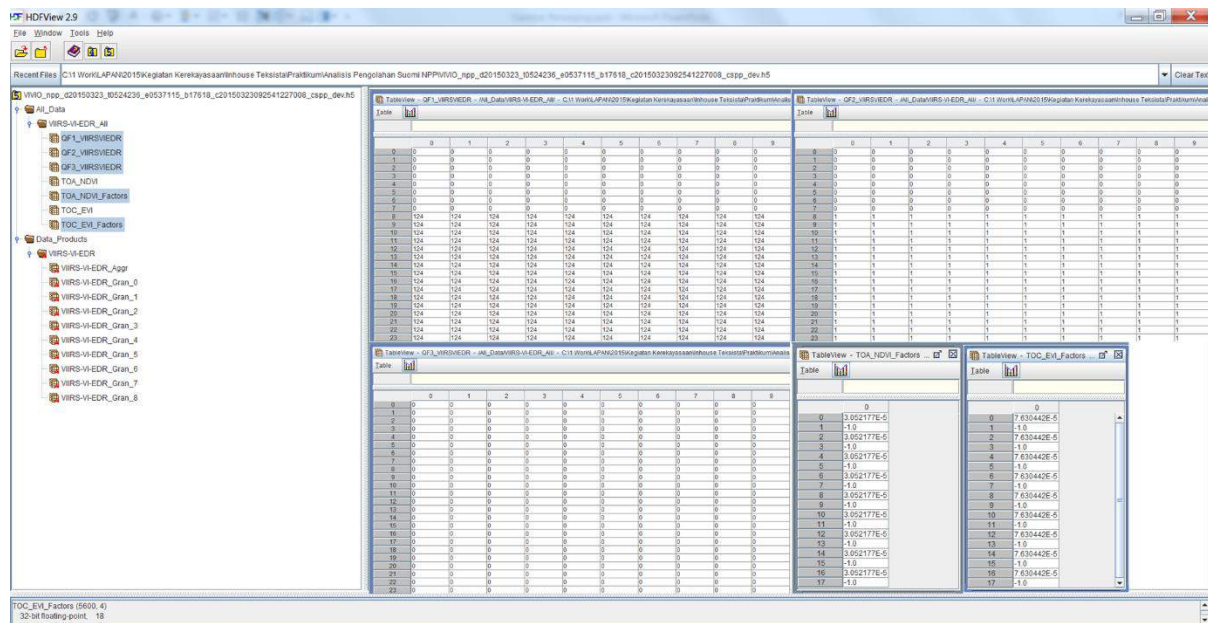
TOA\_NDVI sub data contains values (unitless) of Normalized Difference Vegetation Index – Top of Atmosphere. This values are most directly related to absorption of photosynthetically active radiation, but is often correlated with biomass or primary productivity. TOC\_EVI sub data contains values (also unitless) of Enhanced Vegetation Index – Top of Canopy. Unlike TOA\_NDVI, this values adjust for soil moisture background and minimize feedback and errors from soil and atmospheric effects.



QF1\_VIIRSVIEDR sub data contains values (unitless) of overall NDVI quality, overall EVI quality, availability of related SDR data, and information whether the EVI values is valid or out of range ( $< -1.0$  or  $> 4.0$ ). QF2\_VIIRSVIEDR sub data contains values (unitless) of pixel category (land or water), cloud confidence, sun glint availability in pixel, and thin cirrus detection in pixel. QF3\_VIIRSVIEDR sub data contains values (unitless) of degradation condition, pixel exclusion, snow or ice availability in pixel, adjacency to cloud pixels, aerosol quantity, and cloud shadows. The others sub data just contain additional information that were generated during data processing from SDR level data to vegetation indices data. Sample of detailed sub data contents are illustrated in Figure 5. Explanations about each of the values in the tables can be found in GSFC (2014). Samples of TOA\_NDVI and TOC\_EVI sub data visualization in tabular and image formats is illustrated in Figure 6 and 7, respectively.



**Figure 4** Reading vegetation indices data by using HDFView software.

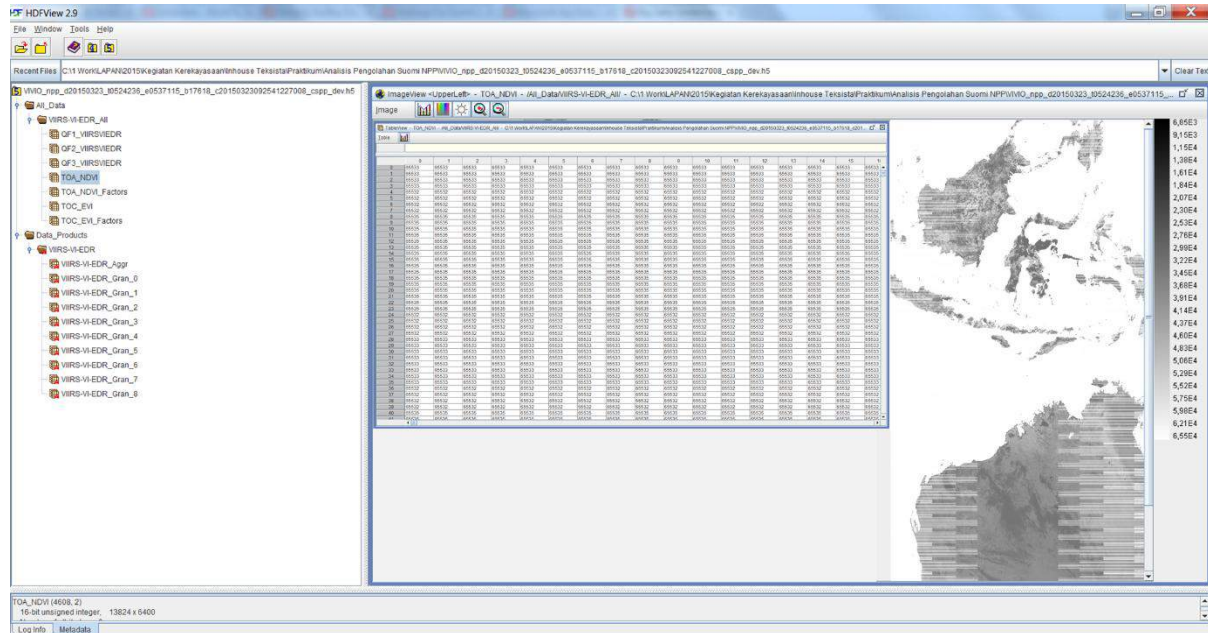


**Figure 5** Sample of detailed sub data contents of a vegetation indices data that is produced by the developed system.

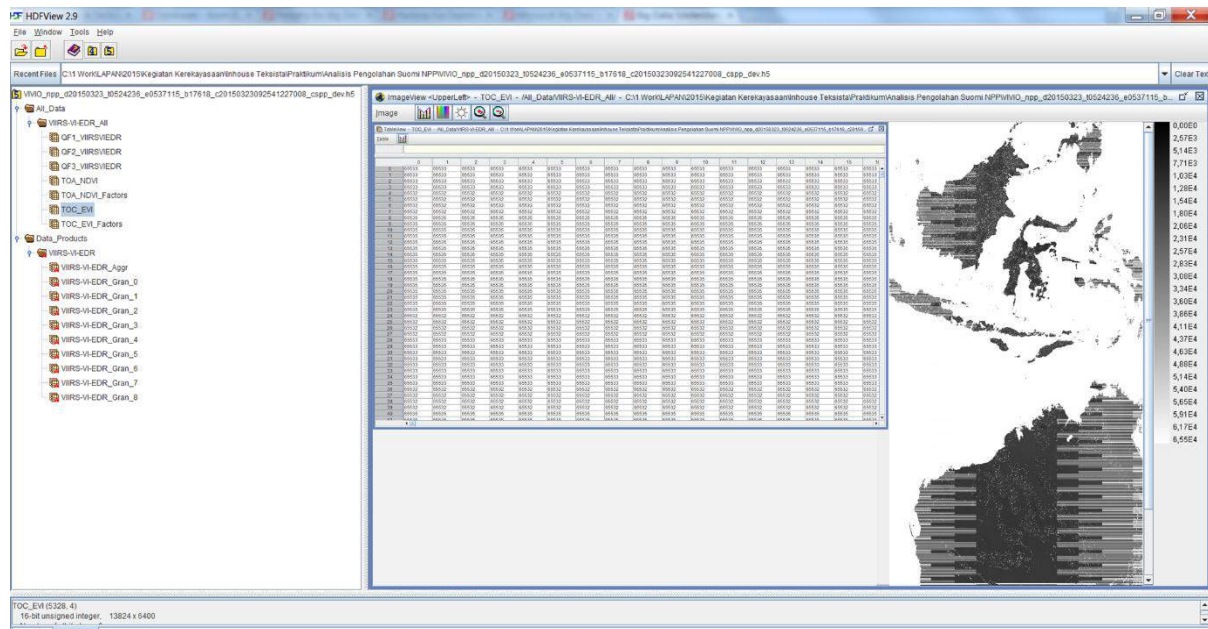
In the previous version of CSPP EDR software, there was a cross granule requirement when three contiguous SDR granules only produces one VI granule. For example, if the software processed seven



granules of SDR, it would produce only five VI granules, while the earliest and the latest granules were took out from the account. Currently, the requirement has been diminished. Thus, the software will produce number of VI granules as many as number of SDR granules that are used as the input.



**Figure 6** Sample of TOA\_NDVI sub data visualization in tabular and image formats by using HDFView software.



**Figure 7** Sample of TOC\_EVI sub data visualization in tabular and image formats by using HDFView software.

One granule of VI data is estimated to have a size of 65.6 MB (GSFC, 2014). It contains 1536 column x 6400 row of pixels with spatial resolution of 375 m in nadir. This size does not include geolocation and metadata attributes as well as additional size added by HDF5 packaging. Hence, in order to know the precise size of VI data, evaluation was taken by using empirical method with sampling approach that was described in the previous section. From the 688 samples data in level rawdata that were successfully processed into VI data, the smallest size of VI data is 68.853.832 Bytes (65.66 MB) and the largest size of VI data is 757.070.240 Bytes (721.99 MB). It means that the smallest VI data contains 1 (one) granule and the largest VI data contains 11 (eleven) granules in one acquisition of Suomi NPP remote sensing satellite data. Details of the evaluation implementation are

illustrated in Table 2. The average size of VI data are 446.769.230 Bytes (426.07 MB) or contains approximately 6 granules.

**Table 2** Evaluation implementation results by using empirical method with sampling approach for VI data that were produced from Suomi NPP remote sensing satellite VIIRS instrument rawdata level data with acquisition date from June 27th, 2014 to February 25th, 2015.

Number(s) of granule in 1 (one) VI data	Numbers of samples	Size of corresponding VI data (in MB)
1	30	65.66
2	28	131.29
3	71	196.92
4	82	262.56
5	74	328.19
6	52	393.82
7	69	459.46
8	67	525.09
9	76	590.72
10	75	656.36
11	64	721.99

LAPAN remote sensing ground station can acquire maximum 4 (four) Suomi NPP remote sensing satellite data in one day. It has been assumed that the satellite's mission lifetime is about 5 years or 1825 days (1 year  $\approx$  365 days), hence, taken the largest size of VI data as consideration for "the worst case scenario", the storage system that will be required to accommodate all the VI data is about  $1825 \times 4 \times 721.99 \text{ MB} = 5.02 \text{ TB}$ .

From the previous activities, the requirement of the storage system in the same period of question to accommodate data in rawdata level is 3.45 TB, RDR level is 1.89 TB (Gustiandi et al., 2013), and SDR level is 22.29 TB (Gustiandi and Indradjad, 2013). Therefore, the total storage system requirement to accommodate Suomi NPP remote sensing satellite data from rawdata level to VI data until the satellite mission over is 32.65 TB. The existing storage system with a capacity of 20 TB must be upgraded to fulfill this requirement.

Besides performance evaluation implementation was taken to know the required storage system, evaluation implementation was also taken to know how long it takes to process Suomi NPP remote sensing satellite data from rawdata level to produce VI data by using the developed system. The fastest processing time was 4 minutes and 22 seconds for Suomi NPP remote sensing satellite data with 1 (one) granule. The longest processing time was 1 hour, 51 minutes, and 10 seconds for Suomi NPP remote sensing satellite data with 11 (eleven) granules. The average processing time was 39 minutes and 51 seconds. The fastest interval time between 2 (two) consecutive Suomi NPP remote sensing satellite data acquisition is 1 hour and 35 minutes. Although the longest processing time to produce VI data from rawdata level data was still longer than the fastest interval time, but from the 688 samples that were measured, only 3 (three) samples that have processing time that exceed the fastest interval acquisition time. Therefore, Suomi NPP remote sensing satellite data processing system that has been developed can be enhanced further to become a near real time system by implementing automation technique. But, the system must be monitored intensively to anticipate the availability of processing time that may still be longer than the fastest interval acquisition time.

## 4 Conclusion

There is a growing concerns that action is needed to produce spatial information that can be utilized in monitoring and inventarising forest condition in Indonesia that is measurable, reportable, and verifiable (MRV). Several efforts have been taken, one of them is by consistently monitoring vegetation indices through remote sensing technique from MODIS instrument of Terra and Aqua satellites. The availability of next-generation satellite instrument data can be utilized to complement the existing monitoring system.

The developed system can process Suomi NPP remote sensing satellite data, particularly VIIRS instrument (successor of MODIS instruments) data which is retrieved by LAPAN remote sensing

ground station in direct broadcast mode to produce vegetation indices data. The availability of vegetation indices data now can be utilized to complement various systems that use vegetation indices data as their input, especially those that utilize data from former MODIS instruments of Terra and Aqua satellites. All of the softwares that were included as part of the developed system are distributed under the GNU GENERAL PUBLIC LICENSE agreement version 3 or open source based, therefore, the developed system can be implemented in other server computers without have to be restricted by license. Moreover, the evaluation results can be used as consideration for building similar system based on storage system capacity requirement and processing time need.

To build the similar system, the storage system is required to have a minimum capacity of 32.65 TB. There are two considerations when the system want to be developed further into a near real time system by implementing automation technique. First, enhancing the computation capability of the server computer, such as increasing processor speed or memory capacity, so that it can process faster than the existing hardware that was described in the previous section. Second, monitoring the system intensively to anticipate the availability of processing time that may still be longer than the fastest interval acquisition time. Although the discussion only focused on one kind of the data – vegetation indices –, it has opened potential to produce other kinds of the data from Suomi NPP remote sensing satellite data through adoption of the developed system.

## 5 References

- American Meteorological Society (AMS). (2012). Town hall meeting: Early success from the Suomi-NPP mission. *Bulletin of American Meteorological Society*, 93, 1760.
- Angelsen, A., & Atmadja, S. (2010). *Melangkah maju dengan REDD: Isu, pilihan dan implikasi*. Bogor, Indonesia: Center for International Forestry Research.
- Ardanuy, P. E., Schueler, C. F., Miller, S. W., Kealy, P. S., Cota, S. A., Haas, J. M., & Welsch, C. (2001). NPOESS VIIRS design process. In W. L. Barnes (Ed.), *Proceedings Earth Observing System VI, SPIE*, 4.483 (pp. 24-34). Bellingham, United States of America: SPIE.
- Asian Development Bank (ADB). (2009). *Ekonomi perubahan iklim di Asia Tenggara*. Mandaluyong, Philippines: Asian Development Bank.
- Barr, C. (2001). *Banking on sustainability: Structural adjustment and forestry reform in post-Suharto Indonesia*. Washington D. C., United States of America and Bogor, Indonesia: Center for International Forestry Research.
- Bass, L., Clements, P., & Kazman, R. (2003). *Software Architecture in Practice 3rd Edition*. Boston, United States of America: Addison Wesley.
- Clark, M. L., Aide, T. M., Grau, H. R., & Riner, G. (2010). A scalable approach to mapping annual land cover at 250 m using MODIS time series data: A case study in the Dry Chaco ecoregion of South America. *Remote Sensing of Environment*, 114, 2816-2832.
- Cooperative Institute for Meteorological Satellite Studies (CIMSS). (2014). Installation instructions for the Community Satellite Processing Package (CSPP) VIIRS, ATMS, and CrIS SDR version 2.0 software for Suomi NPP. Retrieved 2014, August 4 from

[ftp://ftp.ssec.wisc.edu/pub/CSPP/hidden/NPP/SDR/v2.0/CSPP\\_SDR\\_Installation\\_Guide\\_v2.0.pdf](ftp://ftp.ssec.wisc.edu/pub/CSPP/hidden/NPP/SDR/v2.0/CSPP_SDR_Installation_Guide_v2.0.pdf).

- DeFries, R., Achard, F., Brown, S., Herold, M., Murdiyarso, D., Schlamadinger, B., & de Souza Jr., C. (2006). *Reducing greenhouse gas emissions from deforestation in developing countries: Considerations for monitoring and measuring*. Rome, Italy: Global Terrestrial Observing System.
- DeFries, R., Archard, F., Brown, S., Herold, M., Murdiyarso, D., Schalamadinger, B., & de Souza Jr, C. (2007). Earth observations for estimating greenhouse gas emissions from deforestation in developing countries. *Environmental Science and Policy*, 10, 385-394.
- Denman, K. L., Brasseur, G., Chidthaisong, A., Ciais, P., Cox, P. M., Dickinson, R. E., ... Zhand, X. (2007). Couplings between changes in the climate system and biogeochemistry. In S. Solomon, Qin, D., Manning, M., Chen, Z., Marquis, M., Averyt, K.B., ...Miller, H. L. (Eds.), *Climate change 2007: The physical science basis. Report of the Intergovernmental Panel on Climate Change* (pp. 541-544). Cambridge, England: Cambridge University Press.
- Dewanti, R., Agus, S., & Susanna. (1999). Kondisi hutan mangrove di Kalimantan Timur, Sumatera, Jawa, Bali, dan Maluku. *Majalah LAPAN edisi Penginderaan Jauh*, 1(1).
- Flynn, L. E., Seftor, C. J., Larsen, J. C., & Xu, P. (2006). The Ozone Mapping and Profiler Suite (OMPS). In J. J. Qu, Gao, W., Kafatos, M., Murphy, R. E., & Salomonson, V.V. (Eds.), *Earth Science Satellite Remote Sensing: Vol. 1* (pp. 279-296). Berlin, Germany: Springer-Verlag and Beijing, China: Tsinghua University Press.
- Fousseni, F., Guo, H. H., Hai, Z. X., Seburanga, J. L., Mande, S. A., & Koffi, A. (2011). Urban Area Vegetation Changing Assessment over the Last 20 Years Based on NDVI. *Energy Procedia*, 11, 2449-2454.
- Fritz, S., McCallum, I., Schill, C., Perger, C., See, L., Schepaschenko, D., ...Obersteiner, M. (2012). Geo-Wiki: An online platform for improving global land cover. *Environmental Modelling & Software*, 31, 1-14.
- Gantini, T., Hidayat, N., & Kustiyo. (2010). Deteksi kerusakan hutan mangrove di Ujung Kulon dengan inderaja. *Inderaja*, 1(1), 30-34.

- Goddard Space Flight Center (GSFC). (2011). *NPP: Building a bridge to a new era of earth observations* [Brochure]. Washington, United States of America: National Aeronautics and Space Administration.
- Goddard Space Flight Center (GSFC). (2014). *Joint Polar Satellite System (JPSS) VIIRS Vegetation Index (VVI) algorithm theoretical basis document* (Publication No. 474-00063). Retrieved from <http://npp.gsfc.nasa.gov/documents.html>.
- Goddard Space Flight Center (GSFC). (2015a, March 31). *Suomi-NPP National Polar-orbiting Partnership mission details*. Retrieved from [http://npp.gsfc.nasa.gov/suomi\\_mission\\_details.html](http://npp.gsfc.nasa.gov/suomi_mission_details.html).
- Goddard Space Flight Center (GSFC). (2015b, March 31). *Joint Polar Satellite System (JPSS) Common Data Format Control Book – External Volume I – Overview* (Publication No. 474-00001-01-B0124). Retrieved from [http://npp.gsfc.nasa.gov/sciencedocuments/2015-03/474-00001-01\\_JPSS-CDFCB-X-Vol-I\\_0124D.pdf](http://npp.gsfc.nasa.gov/sciencedocuments/2015-03/474-00001-01_JPSS-CDFCB-X-Vol-I_0124D.pdf).
- Goldberg, M. D., & Weng, F. (2006). Advanced Technology Microwave Sounder (ATMS). In J. J. Qu, Gao, W., Kafatos, M., Murphy, R. E., & Salomonson, V.V. (Eds.), *Earth Science Satellite Remote Sensing: Vol. 1* (pp. 243-253). Berlin, Germany: Springer-Verlag and Beijing, China: Tsinghua University Press.
- Gustiandi, B., Indradjad, A., Arief, R., & Bagdja, I.W. (2012). Rancang bangun sistem pengolahan data MODIS untuk produksi informasi indeks kehijauan skala regional. *Inderaja*, 3(4), 50-55.
- Gustiandi, B., & Indradjad, A. (2013). Sistem pengolahan data satelit S-NPP berbasis CSPP: RDR ke SDR, Proceedings of Seminar Nasional dan Expo Teknik Elektro (SNETE) 2013 (pp. 56-62), Banda Aceh, Indonesia.
- Gustiandi, B., Indradjad, A., & Bagdja, I.W. (2013). Rancang bangun sistem pengolahan data satelit Suomi National Polar-orbiting Partnership (S-NPP) dari rawdata ke Raw Data Record. *Majalah Inderaja*, 4(6), 10-14.
- Hansen, M. C., Stehman, S. V., Potapov, P. V., Loveland, T. R., Townshed, J. R. G., DeFries, R. S., ... DiMicelli, C. (2008). Humid tropical forest clearing from 2000 to 2005 quantified by using multitemporal and multiresolution remotely sensed data. *PNAS*, 105(27), 9439-9444.
- Harsanugraha, W. K., Budhiman, S., Dewanti, R., & Suwargana, N. (1999). Pemantauan hutan mangrove di pantura Subang dan Pantai Timur Lampung menggunakan data Landsat-TM.

- Pertemuan Ilmiah Tahunan (PIT) Masyarakat Ahli Penginderaan Jauh Indonesia (MAPIN) ke-8 in Jakarta.
- Januardi, M. F. (1998). *Estimasi biomassa vegetasi mangrove menggunakan data Landsat Thematic Mapper*. Unpublished undergraduate thesis, Institut Pertanian Bogor.
- Jaya, I. N. S. (1997). *Penginderaan jauh satelit untuk kehutanan*. Bogor, Indonesia: Institut Pertanian Bogor.
- Karousakis, K. (2007). *Incentives to reduces GHG emissions from deforestation: Lessons learned from Costa Rica and Mexico*. (Document No. COM/ENV/EPOC/IEA/SLT92007).
- Kross, A., Fernandes, R., Seaquist, J., & Beaubien, E. (2011). The effect of the temporal resolution of NDVI data on season onset dates and trends across Canadian broadleaf forests. *Remote Sensing of Environment*, 115, 1564-1575.
- Kurniawan, I. (2000). *Pemantauan perubahan penutupan lahan pasca kebakaran hutan dengan menggunakan teknik penginderaan jauh satelit dan Sistem Informasi Geografis (studi kasus di wilayah Taman Nasional Berbak-Jambi dan sekitarnya)*. Unpublished undergraduate thesis, Institut Pertanian Bogor.
- Li, Z., & Fox, J. M. (2012). Mapping rubber tree growth in mainland Southeast Asia using time-series MODIS 250 m NDVI and statistical data. *Applied Geography*, 32, 420-432.
- Lilja, D. J. (2000). *Measuring Computer Performance: A Practitioner's Guide*. Cambridge, England: Cambridge University Press.
- Mather, A. (1992). The forest transition. *Area*, 24, 367-379.
- Michael, R. K. (2008). *Mastering UNIX® Shell Scripting Second Edition*. Indianapolis, United States of America: Wiley Publishing, Inc.
- Murphy, R. E. (2006). The NPOESS Preparatory Project. In J. J. Qu, Gao, W., Kafatos, M., Murphy, R. E., & Salomonson, V.V. (Eds.), *Earth Science Satellite Remote Sensing: Vol. 1* (pp.182-198). Berlin, Germany: Springer-Verlag and Beijing, China: Tsinghua University Press.
- Murphy, R. E., Ardanuy, P., Deluccia, F. J., Clement, J. E., & Schueler, C.F. (2006). The Visible Infrared Imaging Radiometer Suite. In J. J. Qu, Gao, W., Kafatos, M., Murphy, R. E., & Salomonson, V.V. (Eds.), *Earth Science Satellite Remote Sensing: Vol. 1* (pp.199-223). Berlin, Germany: Springer-Verlag and Beijing, China: Tsinghua University Press.

- Murphy, R. E., Barnes, W. L., Lyapustin, A. I., Privette, J., Welsch, C., DeLuccia, F., ...Kealy, P. (2001). Using VIIRS to provide data continuity with MODIS. *Proceedings of IGARSS 2001*. Sydney, Australia.
- Pahl, C., Bošković, M., Barrett, R., & Hasselbring, W. (2009). Quality-Aware Model-Driven Service Engineering. In J. Rech & Bunse, C. (Eds.), *Model-Driven Software Development: Integrating Quality Assurance*. New York, United States of America: Information Science Reference.
- Parker, S. (2011). *Shell Scripting: Expert Recipes for Linux, Bash, and More*. Indianapolis, United States of America: John Wiley & Sons, Inc.
- Purwadhi, F. S. H., & Haryani, N. S. (2006). Penilaian lahan untuk tanaman kelapa sawit dari citra Quickbird. *Berita Inderaja*, 5(10), 109-114.
- Salomonson, V. V., Barnes, W., & Masuoka, E. J. (2006). Introduction to MODIS and an overview of associated activities. In J. J. Qu, Gao, W., Kafatos, M., Murphy, R. E., & Salomonson, V.V. (Eds.), *Earth Science Satellite Remote Sensing: Vol. 1* (pp.12-32). Berlin, Germany: Springer-Verlag and Beijing, China: Tsinghua University Press.
- Schueler, C. F., & Barnes, W. L. (1998). Next-generation MODIS for polar operational environmental satellites. *Journal of Atmosphere and Ocean Technology*, 15(2), 430-439.
- Schueler, C. F., Clement, J. E., Ardanuy, P. E., Welsch, C., DeLuccia, F., & Swenson, H. (2001). NPOESS VIIRS sensor design overview. In W. L. Barnes (Ed.), *Proceedings Earth Observing System VI, SPIE, 4.483* (pp. 11-23). Bellingham, United States of America: SPIE.
- Schumacher, J., Luedeling, E., Gebauer, J., Saied, A., El-Siddig, K., & Buerkert, A. (2009). Spatial expansion and water requirements of urban agriculture in Khartoum, Sudan. *Journal of Arid Environments*, 73, 399-406.
- Shoots Jr., W. E. (2012). *The Linux® Command Line: A Complete Introduction*. California, United States of America: No Starch Press.
- Spek, M. (2006). *Financing pulp mills: An appraisal of risk assessment and safeguard procedures*. Bogor, Indonesia: Center for International Forestry Research.
- Stern, S. N. (2006). *Stern review: The economics of climate change*. Cambridge, England: Cambridge University Press.

- Sumaryono. (1999). Pemanfaatan penginderaan jauh untuk pemantauan reboisasi di sub DAS Roraya-Kendari. Pertemuan Ilmiah Tahunan (PIT) Masyarakat Ahli Penginderaan Jauh Indonesia (MAPIN) ke-8 in Jakarta.
- Susskind, J. (2006). Introduction to AIRS and CrIS. In J. J. Qu, Gao, W., Kafatos, M., Murphy, R. E., & Salomonson, V.V. (Eds.), *Earth Science Satellite Remote Sensing: Vol. 1* (pp. 254-278). Berlin, Germany: Springer-Verlag and Beijing, China: Tsinghua University Press.
- Sutanto. (1986). *Penginderaan jauh jilid I*. Yogyakarta, Indonesia: Gadjah Mada University Press.
- The HDF Group. (2013). HDF ESDIS Project. Retrieved 2015, March 31 from <http://www.hdfgroup.org/projects/esdis/index.html>.
- Xiong, X., Chiang, K., McIntire, J., Oudrari, H., Wu, A., Schwaller, M., & Butler, J. (2012). Early assessment of VIIRS on-orbit calibration and support activities. In Geo Geoscience and Remote Sensing Symposium (IGARSS) conducted in Munich, Germany.



## Performance of fastICA Algorithm as Noise Reduction in Cellular Network

<sup>1</sup>Hertiana Bethaningtyas, <sup>2</sup>Imam Abdul Mahmudi, <sup>3</sup>Suwandi

<sup>1</sup>Engineering Physic Telkom University, Bandung Indonesia 40257, hertiana@telkomuniversity.ac.id,  
+6282240036258

<sup>2</sup>Engineering Physic Telkom University, Bandung Indonesia 40257,  
imamabdulmahmudi@students.telkomuniversity.ac.id, +6282247494054

<sup>3</sup>Engineering Physic Telkom University, Bandung Indonesia 40257, suwandi@telkomuniversity.co.id,  
+628112004646

### Abstract

This paper shows about performance of fastICA algorithm as noise reduction to cellular network. The sound that we receive through the cellular network is additive of information signal and noise. In this paper, the simulation is done by adding the sound signal with white Gaussian noise (wgn) which set the value of the impedance. After that, the mixing signal is separated by fastICA algorithm and compare the quality of the signal before and after separated. The parameter value used is the value of jitter, shimmer, and HNR. MSE value obtained from the research, jitter 0.011232, shimmer 0.61349093, and HNR 1.18420. Of these result is required further preprocessing and postprocessing to improve performance of fastICA algorithm

**Keywords :** fastICA, gaussian noise, acoustic parameters, MSE

## 1 Introduction

In a communication system using wireless, noise and interference have significant effects on the system. Noise in the communication system is considered to have the characteristics of the additive, white noise, and Gaussian distributed [2]. Additive noise meaningful existence within the same time frame, experienced superposition (sum) with the information signal is sent. White noise is a noise with the same value for each frequency, and does not depend on the frequency of the system (power spectral density constant). The amount of voltage noise has probability density function gaussian distributed, wherein the pattern of occurrence of noise has zero mean and variance depend on the estimated power density of the noise tersbut, with provisions [2] :

$$f(x) = \frac{1}{\sqrt{2\pi}\sigma} \exp\left(-\frac{x^2}{2\sigma^2}\right)$$

$$P_n = \frac{E[n(t)n^*(t)]}{2} = \frac{E[(x_n(t) + jy_n(t))(x_n(t) + jy_n(t))^*]}{2} = \frac{E[x^2(t)] + E[y^2(t)]}{2} = \frac{\sigma_n^2 + \sigma_n^2}{2} = \sigma_n^2$$

ICA algorithm is a system that is formulated to complete the separation of mixed signals. In wireless communication networks, where signal and noise information can be undescribed as a mixed signal. Signal separation process information on this research by using ICA algorithm. Information used voice is the voice impaired vocal cord reinforced with normal voice data. Such information is mixed with the data of white noise with some changes in impedance. Sound separation results then will be compared with the original voice data.

In this paper we will explain about the performance of ICA as noise reduction in cellular networks. Acoustic parameters to be observed is the value of Jitter, Shimmer, and HNR of the resulting signal. Appearance of data signal spectrograms also necessary to show that the spectrum changes occurred after the separation process. This study became one of the foundations that will be developed in future studies as a medium for sharing information for intrusion detection tool on the vocal cords through the telephone network [1].

## 2 ICA Technique for Noise Reduction

Independent Component Analysis (ICA) is a signal processing method for determining the components forming a mixed signal and comes from sources that are independent statistics. Said to be free if the statistics are not related to each other. Mathematically it can be expressed by the function of the opportunities between events is the product of each event, as in the equation below:

$$p(y_1, y_2) = p(y_1) \cdot p(y_2) \quad (1)$$

Signals derived from sources freely statistics and measurable by a sensor can be expressed by the following equation:

$$x_j = a_{j1}s_1 + a_{j2}s_2 + \dots + a_{jn}s_n \quad (2)$$

Where  $\mathbf{x}$  stating signal measured by the sensor,  $\mathbf{s}$  stating the source, and  $\mathbf{a}$  is an unknown mixing matrix. The above equation is the basic idea in the ICA component analysis. The above equation can be simplified into the following ICA models:

$$x = As \quad (3)$$

When the mixing process the signal from the source lasted a moment, equation six can be written in the frequency domain as follows:

$$x(\omega) = A(\omega) \cdot s(\omega) \quad (4)$$

With regard  $s$  are statistically independent sources, the free component is a hidden variable, which means that it can not be observed directly. After estimating the matrix  $A$ , do the inverse of the matrix  $A$  and is denoted by  $W$  which will be used to get free components [8]. With  $s$  is free statistics, then the inverse of equation 6 can be written as follows:

$$s = Wx \quad (5)$$

Signal separation process with ICA method can be illustrated by the block diagram in Figure 1.

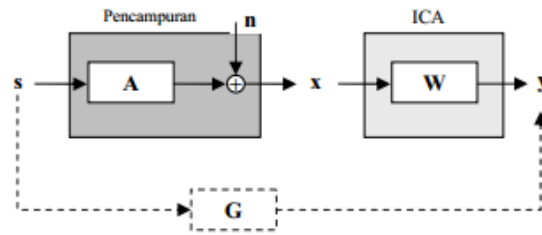


Figure 1 Blok Diagram ICA [11]

In the picture above 1 is shown a model of the ICA. Denoted  $s = (s_i)$  as  $m \times 1$  vector signal source and  $x = (x_i)$  as an  $n \times 1$  vector signal observed by the sensor. As already mentioned,  $A$  is an  $n \times m$  mixing matrix and  $W$  is the matrix of  $m \times n$  unmixing matrix. Global matrix  $G$  is the matrix of the changes of the signal source to the source signal estimate  $y$ . ICA algorithm ideal for the matrix  $G$  is the identity matrix ( $I$ ). The matrix  $G$  is used to measure the performance of an ICA algorithm.

Problems on the model of ICA is to find the filter separator  $W$ , the selection of appropriate filters and optimal  $W$  will affect the signal quality estimation. There are several ICA algorithms are used. Each - each algorithm has the advantages of each other and over the years these algorithms continue to be refined. Several algorithms for optimization is Infomax ICA, Natural Gradient, and FastICA.

FastICA algorithm ICA model with non-gaussianity approach based on n-gentropy with fixed point iteration or the Newton iteration which produces the same equation. Rules weighting filter separator on fastICA algorithm is determined by the following equation:

$$w^t = w - \frac{E\{xg(w^T x)\} - \beta w}{E\{xg(w^T x)\} - E\{g'(w^T x)\}w} \quad (6)$$

The function  $g$  is a derivative of the contrast function. FastICA algorithm is a technique that is faster than the previous algorithm converges.

### 3 Experimental Setup

#### 3.1 Participants

Data were collected at twenty-five participants who had been diagnosed with throat disorders and twenty-five in a normal voice both men or in women with age above 20 years. Collecting data in collaboration with Dustira Hospital, Cimahi Indonesia. This selection is based on the use of algorithms fastICA to reduce interference on the telephone network to detect abnormalities on the vocal cords.

Voice recording is done continuously with mengucapkan one vowel, vowel used is / a / [3]. Distance microphone (mic brand) with participants is set at 10 cm [3]. average recording is done for 7-20 seconds for each participant. Recording is done by using GoldWave software

and stored as .wav. Recording is done in a room with minimal acoustic conditions. The sampling frequency of 44100 Hz with 16 bits of resolution and mono.

### 3.2 Speech Parameter

Recording is done by using a microphone and ADC. The parameters used to determine the quality of the sound is the value of jitter, shimmer, and HNR.

#### 4.2.1. Menentukan Nilai Jitter

Jitter is the time difference of two consecutive periods. Jitter is a delay variation, which indicates the number of delay variation on the network. The larger the jitter value will decrease perfomansi of the network. To illustrate the successive periods is done by determining the time base period characterized by the peak levels depicted in Figure 2.

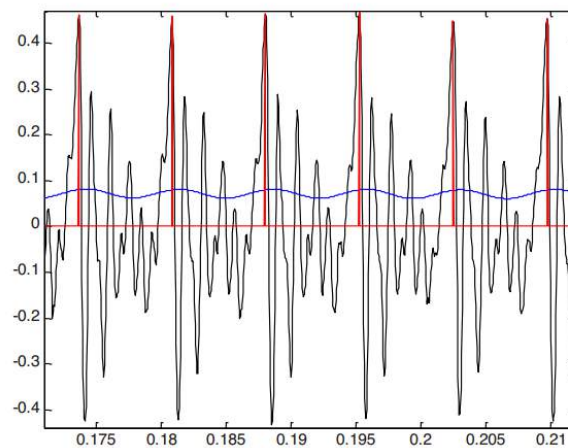


Figure 2 representation of peak signal in woman voice [3]

Jitta illustrates the average absolute differences between two consecutive periods. Maximum limit for normal jitta value is 83.2µs [3].

$$jitta = \frac{1}{N-1} \sum_{i=1}^{N-1} |T_i - T_{i-1}| \quad (7)$$

Jitt is the average absolute differences between two consecutive periods divided by the average of the period. Maximum limit for normal jitt value is 1.04% out [3]

$$jitt = \frac{jitta}{\frac{1}{N} \sum_{i=1}^N T_i} \times 100 \quad (8)$$

## 4.2.2. Menentukan Nilai Shimmer

To calculate the value of a shimmer of suatu sound signal, the method used is equal to the difference if jitter associated with the period, shimmer associated with the amplitude of a signal. Shimmer (local) illustrates the average absolute amplitude differences with successive period divided by the average amplitude. Maximum limit for normal voice is 3.81% [3].

$$Shim = \frac{\frac{1}{N-1} \sum_{i=1}^{N-1} |A_i - A_{i+1}|}{\frac{1}{N} \sum_{i=1}^N A_i} \quad (9)$$

Shimmer (local, dB) illustrates the average absolute amplitude of successive differences in logarithmic form (ShdB). ShdB maximum limit for normal voice is 0350 dB [3].

$$ShdB = \frac{1}{N-1} \sum_{i=1}^{N-1} \left| 20 * \text{Log} \left( \frac{A_{i+1}}{A_i} \right) \right| \quad (10)$$

## 3.3 Data Analysis

### 3.3.1 Preprocessing

The data preprocessing by centering. This preprocessing aims to simplify the ICA algorithm. Preprocessing process is by subtracting the average of the observed data [3]. Without preprocessing iteration process can achieve 500 times and can not be determined value unmixing matrix. By preprocessing process is done, the iteration to 6 times the value of unmixing matrix A.

$$A = \begin{bmatrix} 0.74811 & -0.1446 \\ -0.1446 & 0.7481 \end{bmatrix}.$$

### 3.3.2 ICA

ICA process is done in two stages, by making their own algorithms and use fastICA 2.5 [5]. fastICA 2.5 is a MATLAB-based ICA tool that includes a number of analysis and visualization techniques set in a user-friendly graphical interface [6].

Based on previous studies, the information signal is the sum of the observed data and the noise [7]. Noise in this paper is a gaussian noise with impedance value is 40 ohm, 50 ohm and 60 ohm. At Figure 3 represent difference value of the noise amplitude .

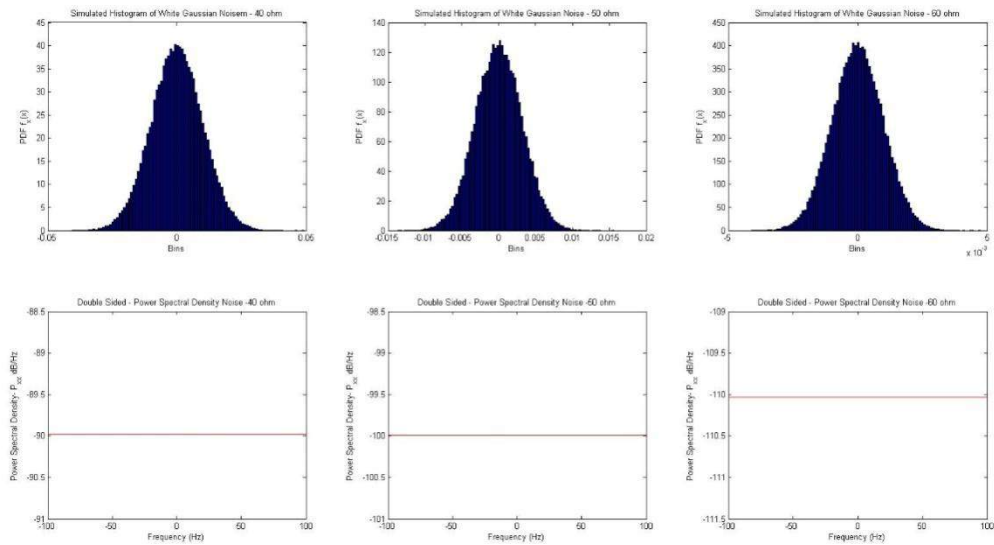


Figure 3 histogram and power spectral density of gaussian noise in difference impedance

Figure 4 shows a scatter plot of the voice signal and noise signal, on the graph shows that the noise and signal noise there is no correlation or independent. Therefore, ICA technique can be used as a reducing noise as one of the principal use ICA algorithm is data independent [8]. In figure 4 it can be seen in addition to the correlation between the noise and the sound signal is also seen histograms of the two pieces of the signal. Noise signal (x axis) has a Gaussian distribution, while the voice signal (y-axis) has nongaussian distribution. Based on the principle of ICA one nongaussian distribution of data must have to do with the separation process ICA algorithm [4].

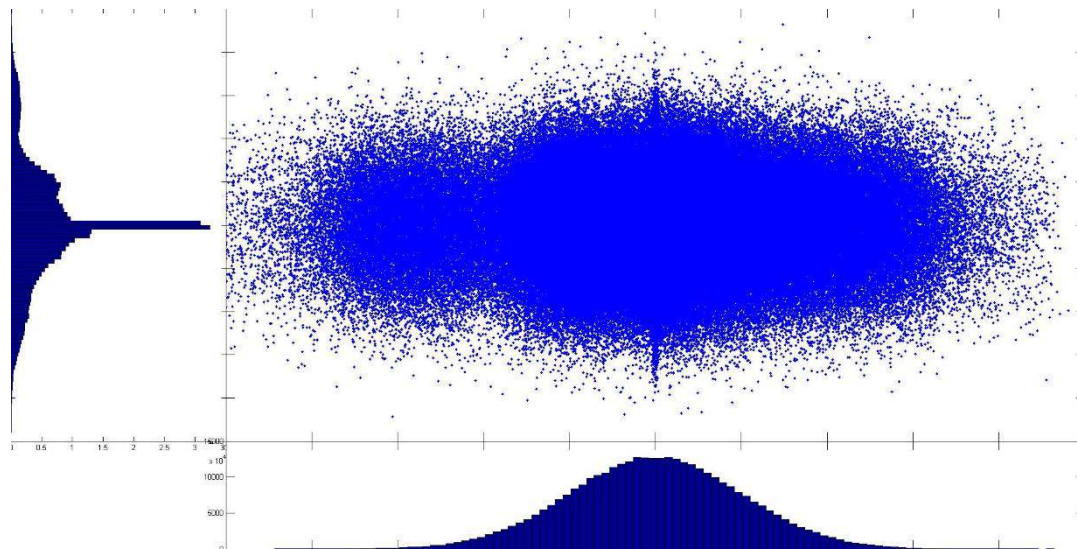


Figure 4 scattering plot between noise signal and information signal

Noise that occurs can destroy the information signal, as shown in Figure 5 is the spectrograms of the signal without noise (above) with a signal to noise (below). Spectrogram type used is a type of wideband spectrogram. Wideband spectrogram a spectral analysis on a 15-millisecond intervals using a filter with a bandwidth of 125 Hz as well as detailed analysis of every 1 millisecond. In spectrogram be seen that the signal to noise has spectrogram with the original signal, noise often found in high frequencies.

Information on the human voice is contained in the low frequency 0-5 kHz as shown in figure 3. At higher frequencies in the sound information will decay and disappear, while the sound signal is given gaussian noise damaging information so that the information remains at low frequencies but at higher frequencies there is information that is damaging the information.

Therefore we need a noise reduction system, many algorithms have been made to reduce noise such as LPF and BPF [9], wavelet [10], and ICA [8].

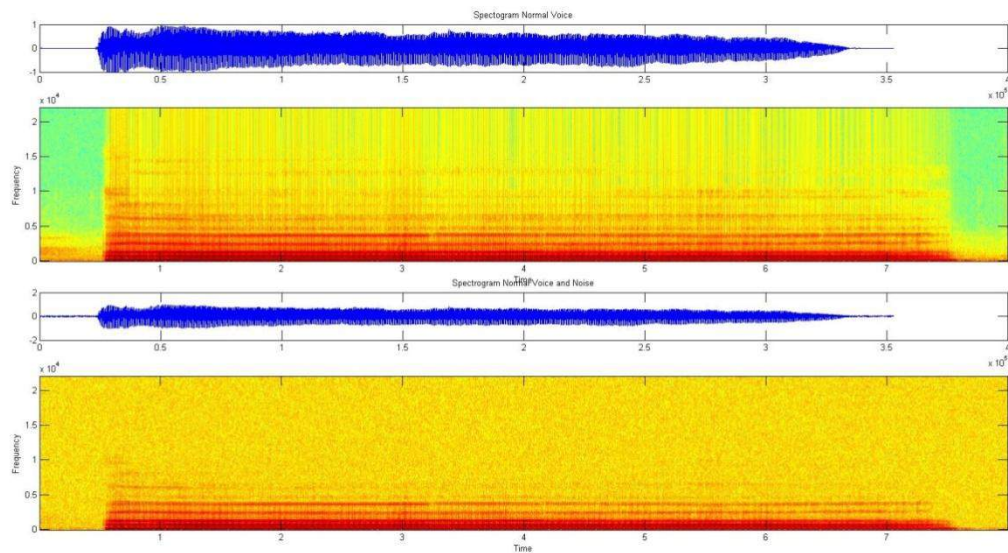
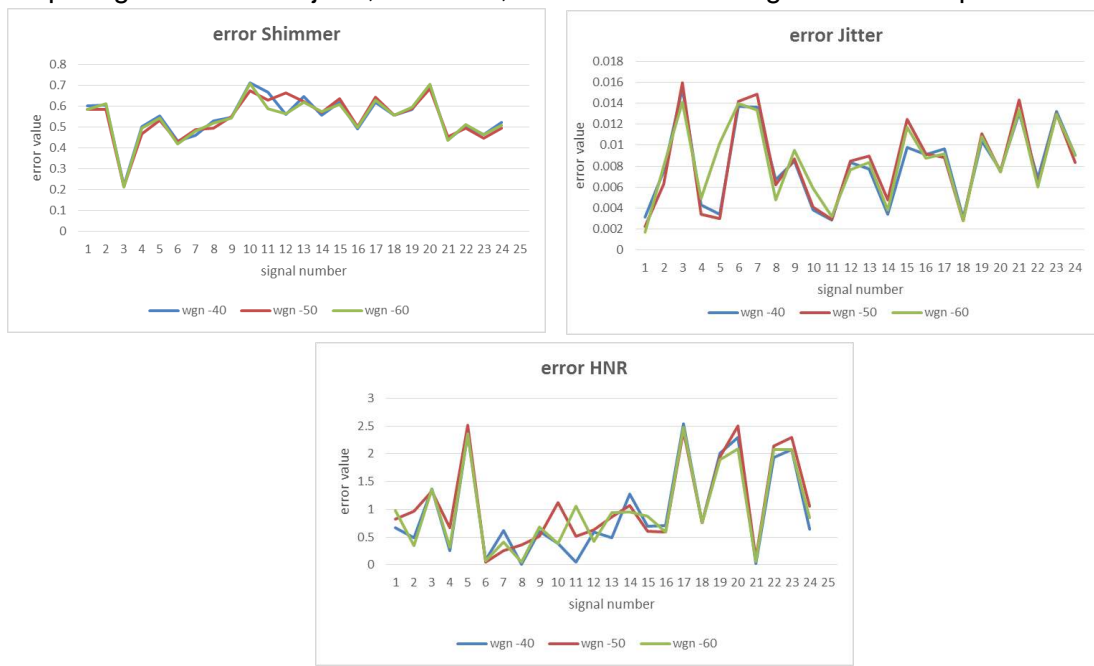


Figure 5 spectrogram of information signal with noise (bottom) and without noise (up)

After the noise reduction process using ICA calculation of the separation quality by comparing the value of jitter, shimmer, and HNR of the signal before separation and after



separation. Jitter error value on the third different impedance value has a value approximately equal to the maximum value of the jitter error of 0.015957. In shimmer has the same characteristics with the jitter error due to jitter and shimmer processing in the frequency domain is a domain. Maximum error value on the shimmer of 0.711758. HNR error values with different noise impedance values have diverse characteristics of error, it is because the calculation HNR based on the signal amplitude. The highest error on HNR value of 2.5376. The highest error value lies in noise with value -40 ohm impedance. At -40 ohm impedance value of the power spectral density of -90 dB / Hz and highest value between -50 and -60 ohm ohms.

Figure 6 error of acoustic parameter after ICA process

#### **4 Conclusion**

Simulation of noise reduction in this paper to determine the performance of ICA algorithm to reduce noise on the telephone network. Simulations carried out by summing the signal information with gaussian noise with a sound different impedance values. The greater the impedance niali given as noise, power spectral density values greater that mengakibatkan error value the greater the quality of the acoustic parameters. The largest error value -40 ohm impedance spectral density value of -90 dB/Hz. Error value of acoustic parameters is still large that need to be postprocessing to improve the quality of noise reduction.

The simulation proved that fastICA can be used to reduce noise in a cellular network that will be used as a reducing noise for detection vocal cord disorder in the mobile network will be done next research.

#### **References**

- [1] Kusumaningrum, H. B. D.,(2011). Penerapan Metode Sinusoidal Modelling Ana Synthesis untuk Perbaikan Sinyal Suara pada Komunikasi Nirkabel, Surabaya: Institut Teknologi Sepuluh,November
- [2] Hartanto, Sri.(2010).Pengurangan Bit Error pada Modulasi M-QAM dalam kanal Rayleigh dengan Teknik Spatial Multiplexing dan Metode ZF-SIC, MMSE-SIC, Maximum Likelihood.
- [3] Paulo, J.,Oliveira, C. & Lopes, C.,(2013).Vocal Acoustic Analysis – Jitter, Shimmer and HNR Parameters.Procedia Technology 9, 1112-1122.
- [4] Hyvärinen, Aapo & Oja, Erkki.(2000).Independent Component Analysis : Algorithms and Application. Neural Networks, 13(4-5), 411-430.
- [5] The FastICA MATLAB package. Available at <http://www.cis.hut.fi/projects/ica/fastica/>
- [6] Lee, J., Vrins, F., & Verleysen, M.,(2006). Non-orthogonal Support-Width ICA. ESANN'2006 proceeding, 351- 358.



- [7] Moulines, E., Cardoso, J. & Gassiat, E., (1997). Maximum Likelihood for Blind Separation and Deconvolution of Noisy Signals using Mixtures Models. *IEEE*, 3617-3620.
- [8] Zhang, Z. & Etoh, M., (2007). ICA-Based Noise Reduction for Mobile Phone Speech Communication. *IEEE*. 470-473.
- [9] Kusmoto, A., et al. (2005). Modulation Enhancement of Speech by a pre-Processing Algorithm for Improving Intelligibility in Reverbant Environments. *Speech Communication* 45, 101-113.
- [10] Lu, Ching-Ta & Wang, H., (2003). Enhancement of Single Channel Speech Based on Masking Property and Wavelet Transform. *Speech Communication* 41, 409-427.
- [11] Buwono, Andi, Hidayatno, A., Santoso, I., Pemisahan Komponen Sumber Sinyal Dterministik dengan Analisis Komponen Independen. Universitas Diponegoro.

## Simulation of Single Microring Resonator (MRR) using FDTD Technique for Sensing Applications

<sup>1</sup>Budi Mulyanti, <sup>1</sup>Tommi Hariyadi, <sup>1</sup>Arjuni B. Pantjawati, <sup>2</sup>Lilik Hasanah,  
<sup>3</sup>Heru Yuwono, <sup>4</sup>P. Suthita Menon, and <sup>4</sup>Sahbudin Shaari

<sup>1</sup>Department of Electrical Engineering Education,  
<sup>2</sup>Department of Physics Education,  
Universitas Pendidikan Indonesia (UPI),  
Jl. Dr. Setiabudhi 207, Bandung 40154, Indonesia,  
<sup>3</sup>Arsari Group, Jl. Jend. Sudirman,  
Kav 10-11, Jakarta Selatan, Indonesia,  
<sup>4</sup>Institute of Microengineering and Nanoelectronics (IMEN),  
Universiti Kebangsaan Malaysia (UKM), 43600 UKM Bangi, Selangor, Malaysia.

[b\\_mulyanti@yahoo.com](mailto:b_mulyanti@yahoo.com)

**Abstract.** Several analytic approaches have been used to model the propagation of electromagnetic wavefronts as well as the parameters characterizing a photonic structure. In this paper, FDTD (finite difference time domain) technique is used to yield the reliable simulation results of single microring resonator (MRR) for sensing application. The simulation uses a device model which is embedded on the high index contrast (HIC) structure of silicon-on-insulator (SOI) with monomodal cavity for TE-mode polarizations, operating around 1550 nm optical wavelength. The bus waveguides serve as evanescent light input and output couplers, while the ring waveguide acts as the wavelength selective element. The parameters used in the simulation including the radius of ring waveguide, the waveguide width, the total waveguide height and the separation gap between straight and ring waveguide. The sensitivity of MRR-based sensor highly depends on the value of Q-factor, hence the aim of the simulation is to obtain the values of Q-factor of proposed MRR design as a function of the coupling length of ring waveguide and the separation gap, while the other parameters are kept constant. Generally, the higher Q-factor can be obtained by expanding the separation gap and reducing the coupling length of the ring waveguide, yet the magnitude of transmission response of output power reduced, as well.

Keywords: microring resonator, FDTD, SOI, Q-factor, transmission response

### INTRODUCTION

Nowdays, sensing application in areas of chemical and bio-chemical detection have attracted interest due to their advantages which directly related to human life such as detection of bacteria and viruses, health diagnosis, quality control of medicine and food, as well as environmental pollutant. The need of such sensors have triggered the development of ultrasensitive devices that can detect biomolecules with a very low concentration of [1].

Compared to other types of sensors, like chemical and MEMS sensor, optical sensor has many advantages, namely are easier to integrate with other components [2] and does not require any complex apparatus or fabrication techniques, especially for optical sensor on SOI, it can be fabricated in an existing CMOS fabrication facility [3,4].

One of optical sensor uses microring resonators(MRRs) as an element that select the incident wavelength for synthesizing filter function in a large quantities and very small sizes, with the density of up to 100,000 devices per  $\text{cm}^2$  [5]. There are two different models of MRRs based sensing, first one is homogenous sensing and the second one is surface sensing [1]. For homogenous sensing, the analytes are suspended in an aqueous medium over the ring and change the refractive index of cladding layer which in turn lead to the change in the effective index,  $n_{\text{eff}}$ . The change in the  $n_{\text{eff}}$  then produces the shift in resonanse wavelength at the drop port. For surface sensing a chemical layer is coated over the ring and attract as well as adhere to the analytes. This increases the thickness of the ring which in turn changes the  $n_{\text{eff}}$  and hence the shift in resonance wavelength [4]. In other words, MRRs for sensor applications use evanescent wave to examine the present of analytes at the device's surface or in the surrounding medium by detecting the effective refractive index change [1].

Considering that MRRs sensors provide many benefits regarding compatibility with CMOS technology and integration on chips [3], sensitivity and selectivity [4], in this paper, we study a MRRs device model which is embedded on the high index contrast (HIC) structure of silicon-on-insulator (SOI). The bus waveguides serve as evanescent light input and output couplers, while the ring waveguide acts as the wavelength selective element [6 Mulyanti, 2014]. MRRs have a variety of applications [7,8,9] in which each application demands special requirements for instance MRRs used in sensors require a high Q-factor [4].

Nowdays, FDTD (finite difference time domain) technique is one of the most popular tool to solve Maxwell's equation [10]. Many commercial softwares have been developed based on FDTD technique, such as CST, XFDTD, SEMCAD, RSoft, and Lumerical. Maxwell's equations can be solved using FDTD in the time domain as well as wide band frequency domain using Fourier transform. FDTD can easily handle a variety of geometric shapes consisting of various types of materials including dielectric, magnetic, frequency-dependent materials, nonlinear and anisotropic materials. Features in electromagnetic computational technique of FDTD are very attractive to solve various applications such as microwave devices, antennas,

radar cross section, wave propagation, waveguide, and optical devices. Therefore, in this study FDTD technique used to design MRR as an optical devices by obtaining a high Q-factor for sensing application. The parameters used in the simulation including the circumference of ring waveguide, the waveguide width, the total waveguide height and separation gap between straight and ring waveguide.

## RESEARCH METHOD

### *MRR Design and Parameters used*

Figure 1 shows a lay out and cross section of ring resonator waveguide closely coupled to double straight bus waveguides.  $R$  depicts the ring radius,  $gap$  is the separation distance between straight and ring waveguide,  $W$  is the waveguide width and  $H$  is the total waveguide height. The cross-section of such waveguides was chosen to ensure single-mode propagation near 1550nm telecommunications wavelengths [11]. For simulation purpose, we used parameters as shown in table 1. The parameters including incident wavelength, ring radii of circular waveguide, separation width (gap) between circular and straight waveguides, the dimension of waveguides, and refractive index of  $SiO_2$  as lower cladding, silicon as the core, and air as upper cladding.

Table 1. Parameters used in this simulation.

No.	Parameter	Value	No.	Parameter	Value
1.	Refractive index of $SiO_2$	1.444	6.	Width of waveguides	$0.4 \mu m$
2.	Refractive index of Si	3.477	7.	Incident wavelength	$1.55 \mu m$
3.	Refractive index of air	1.00	8.	Ring radius	$3.4-4.2 \mu m$
4.	Thickness of $SiO_2$	$1 \mu m$	9.	Gap (separation width)	$100-200 \text{ nm}$
5.	Thickness of Si core	$0.18 \mu m$	10.	Coupling Length	$0-2.5 \mu m$

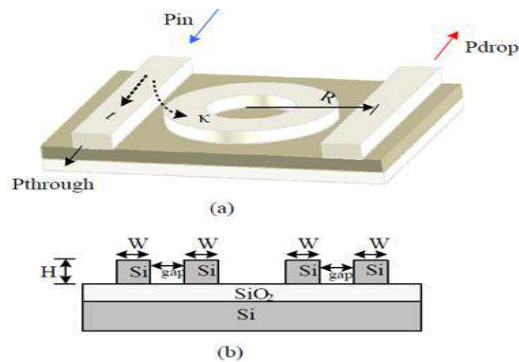


Figure 1. (a) Lay out and (b) cross section of single MRR with double straight waveguides [6]

### MRR Theory

FSR (free spectral response) is defined as a distance of two adjacent peak intensity [6], therefore:

$$FSR = 2\pi c/L \quad (1)$$

Where L is a circumference of microring circle and  $c$  is speed of light in a medium that can be expressed as:

$$c = \frac{c_0}{n_{eff}} \quad (2)$$

Where  $c_0$  is speed of light in the vacuum.

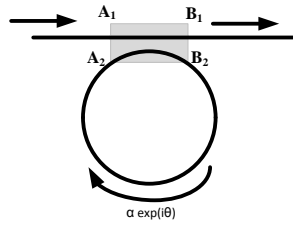


Figure 2. Light wave transmitted in the straight waveguide

And the total power in the microring in Figure 2 is [12]:

$$|a_2|^2 = \frac{\alpha^2(1-|t|^2)}{1 + \alpha^2|t|^2 - 2\alpha|t| \cos(\theta + \phi_t)} \quad (3)$$

If  $\theta = \omega L/c$ , then from equation (10), full width at half maximum (FWHM) can be obtained from:

$$\Delta\omega_{FWHM} \cong \frac{2(1-|t|^2)c}{L} = \frac{2\kappa^2 c}{L} \quad ; \quad \alpha = |t| \approx 1 \quad (4)$$

And the Q-factor function can be expressed as:

$$Q = \frac{\omega}{(\Delta\omega)_{FWHM}} = \frac{\pi f L n_{eff}}{c_0(1-|t|^2)} = \frac{\pi L n_{eff}}{\lambda_0 |\kappa|^2} \quad (5)$$

### FDTD Technique

FDTD technique was first used by Yee [12] to analyze the two-dimensional problem of scattering pulse transverse magnetic (TM) of a rectangular conductor cylinder. This technique was then extended for three-dimensional cases of steady state excitation by Taflove and Brodwin [14]. With the increase in computing capability by the end of the seventies, the more complex problem can be then solved by this technique [15].

This FDTD technique based on second order central difference approximation in space and time to solve Maxwell's equations in which differential equations was replaced by the set of finite difference equations in the following scalar equations:

$$\frac{\partial E_x}{\partial t} = \frac{1}{\epsilon_x} \left( \frac{\partial H_z}{\partial y} - \frac{\partial H_y}{\partial z} - J_x \right) \quad (6.a)$$

$$\frac{\partial E_y}{\partial t} = \frac{1}{\epsilon_y} \left( \frac{\partial H_x}{\partial z} - \frac{\partial H_z}{\partial x} - J_y \right) \quad (6.b)$$

$$\frac{\partial E_z}{\partial t} = \frac{1}{\epsilon_z} \left( \frac{\partial H_y}{\partial x} - \frac{\partial H_x}{\partial y} - J_z \right) \quad (6.c)$$

$$\frac{\partial H_x}{\partial t} = \frac{1}{\mu_x} \left( \frac{\partial E_y}{\partial z} - \frac{\partial E_z}{\partial y} \right) \quad (6.d)$$

$$\frac{\partial H_y}{\partial t} = \frac{1}{\mu_y} \left( \frac{\partial E_z}{\partial x} - \frac{\partial E_x}{\partial z} \right) \quad (6.e)$$

$$\frac{\partial H_z}{\partial t} = \frac{1}{\mu_z} \left( \frac{\partial E_x}{\partial y} - \frac{\partial E_y}{\partial x} \right) \quad (6.f)$$

The derivative of equation (6.a) can be approximated using central difference formula in which the position of  $E_x(i, j, k)$  and the time of  $\left(n + \frac{1}{2}\right) \Delta t$  are considered to be the midpoint of central difference formula in space and time, respectively.

Grid point can be expressed as:

$$(i, j, k) = (i\Delta x, j\Delta y, k\Delta z) \quad (7)$$

And for each spacial dan time functions can be expressed as:

$$F(i\Delta x, j\Delta y, k\Delta z, n\Delta t) = F^n(i, j, k) \quad (8)$$

Based on central difference point [16]:

$$\frac{df(x)}{dx} = f'(x) = \frac{f\left(x+\frac{1}{2}\Delta x\right) - f\left(x-\frac{1}{2}\Delta x\right)}{\Delta x} \quad (9)$$

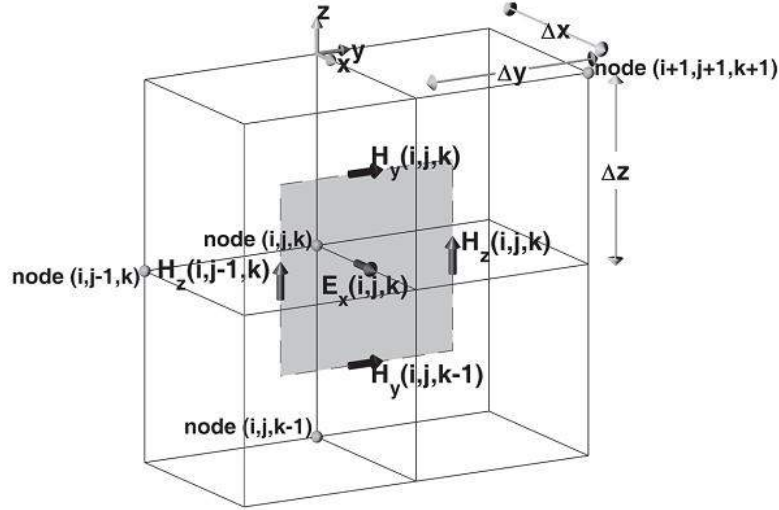


Figure 3. Field components of  $E_x(i, j, k)$  [10]

The derivate of Eq. 6a can be approximated using central difference formula for position of  $E_x(i, j, k)$  on central point of central difference formula in space and certain time and  $(n + \frac{1}{2}) \Delta t$  as central point in time. From Figure 3, it can be expressed as:

$$\frac{E_x^{n+1}(i, j, k) - E_x^n(i, j, k)}{\Delta t} = \frac{1}{\varepsilon_x(i, j, k)} \left( \frac{H_z^{n+\frac{1}{2}}(i, j, k) - H_z^{n+\frac{1}{2}}(i, j-1, k)}{\Delta y} - \frac{H_y^{n+\frac{1}{2}}(i, j, k) - H_y^{n+\frac{1}{2}}(i, j, k-1)}{\Delta z} - j_x^{n+\frac{1}{2}}(i, j, k) \right) \quad (10)$$

And then:

$$E_x^{n+1}(i, j, k) = E_x^n(i, j, k) + \frac{\Delta t}{\varepsilon_x(i, j, k)} \left( \frac{H_z^{n+\frac{1}{2}}(i, j, k) - H_z^{n+\frac{1}{2}}(i, j-1, k)}{\Delta y} - \frac{H_y^{n+\frac{1}{2}}(i, j, k) - H_y^{n+\frac{1}{2}}(i, j, k-1)}{\Delta z} - j_x^{n+\frac{1}{2}}(i, j, k) \right) \quad (11)$$

Eq. 11 is called FDTD *updating equation*. We can obtain updating equation of  $E_y^{n+1}(i, j, k)$  from Eq. 6.b and  $E_z^{n+1}(i, j, k)$  from Eq. 6.c following the same procedur for obtaining Eq. 11.

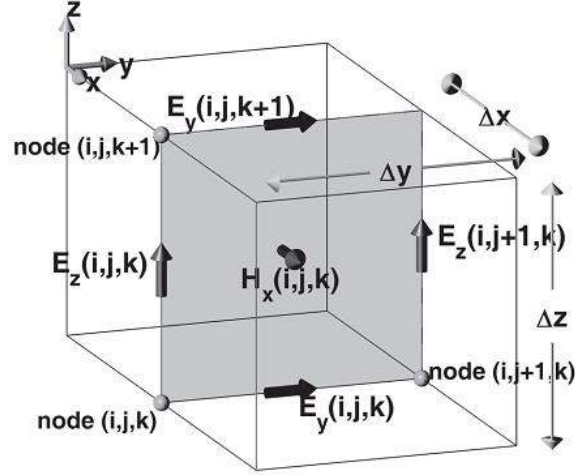


Figure 4. Field components of  $H_x(i, j, k)$  [10]

The updating equation of magnetic field components can also be obtained using the same procedure. Yet the central difference formula should be used for derivation to time of magnetic field component, the central point in time should be taken as  $n\Delta t$ . For example Eq. 6.d can be approximated using central difference formula based on the position of magnetic field in Figure 4.

$$\frac{H_x^{n+\frac{1}{2}}(i, j, k) - H_x^{n-\frac{1}{2}}(i, j, k)}{\Delta t} = \frac{1}{\mu_x(i, j, k)} \left( \frac{E_y^n(i, j, k+1) - E_y^n(i, j, k)}{\Delta z} - \frac{E_z^n(i, j+1, k) - H_z^n(i, j, k)}{\Delta y} \right) \quad (12)$$

By putting the term of  $H_x^{n+\frac{1}{2}}(i, j, k)$  to the left side dan another terms were moved to right side, then we have:

$$H_x^{n+\frac{1}{2}}(i, j, k) = H_x^{n-\frac{1}{2}}(i, j, k) + \frac{\Delta t}{\mu_x(i, j, k)} \left( \frac{E_y^n(i, j, k+1) - E_y^n(i, j, k)}{\Delta z} - \frac{E_z^n(i, j+1, k) - H_z^n(i, j, k)}{\Delta y} \right) \quad (13)$$

To obtain the updating equation of  $H_y^{n+\frac{1}{2}}(i, j, k)$  we may begin from Eq. 6.e and  $H_z^{n+\frac{1}{2}}(i, j, k)$  from Eq 6.f using the same procedure for obtaining Eq. 13.

## RESULTS AND DISCUSSION

The simulations were carried out by varying coupling length and waveguide separation distance (gap) of 0-2.5  $\mu\text{m}$  and 100-200 nm, respectively at incident wavelength of 1.55  $\mu\text{m}$ . The other parameters are kept constant, including  $\text{SiO}_2$  and Si refractive index of 1.5277 and



3.4777, respectively, SiO<sub>2</sub> and Si height of 1.0 and 0.55 μm, respectively and the waveguide width of 0.30 μm. In this simulation the value of circumference of ring waveguide is also kept constant, hence the value of the FSR (free spectral range) can be maintained. The result of simulation for the influence of coupling length to the Q function can be seen in Figure 5.

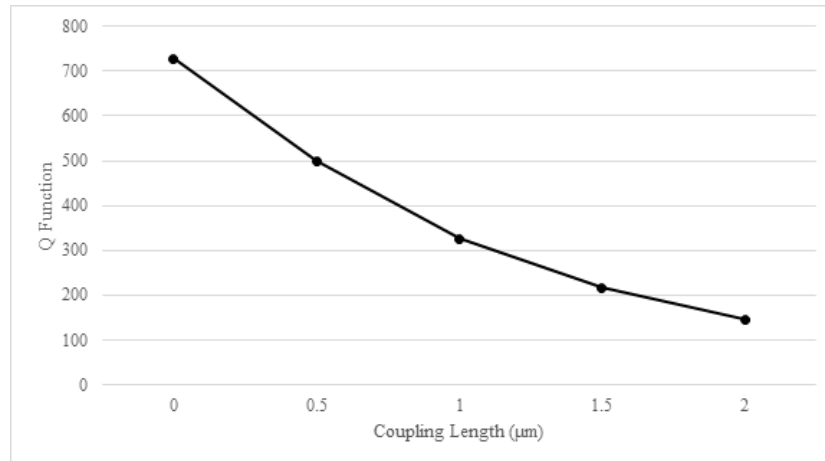


Figure 5. The values of Q-factor function for different values of coupling length

It can be seen that the value of the Q function is inversely proportional to the coupling length of ring waveguide. The longer the coupling length the smaller the Q function. As mentioned previously, for sensor the high Q function is required so that resonant coupling length is designed as short as possible. In this simulation we have only varied the coupling length up to 2 μm. When the value set to be 2.5 μm, the Q function can not be longer determined since before the magnitude reaches a value of half of the maximum, the transmission response has climbed back as shown in figure 6.

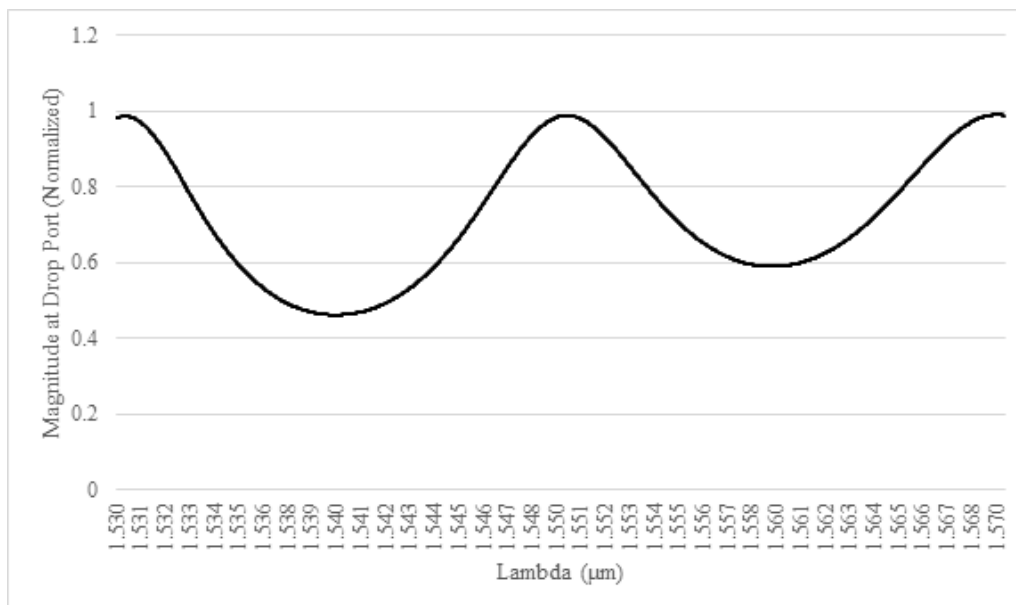


Figure 6. The magnitue of transmission response at drop port for different values of wavelength.

In order to determine the effect of separation gap to the Q-factor function, we varied the value of gap separation in the range of 100 to 200 nm with a multiple of 10 nm, while the other parameters were kept constant and there is no coupling length. The result of the simulation is shown in Figure 7.

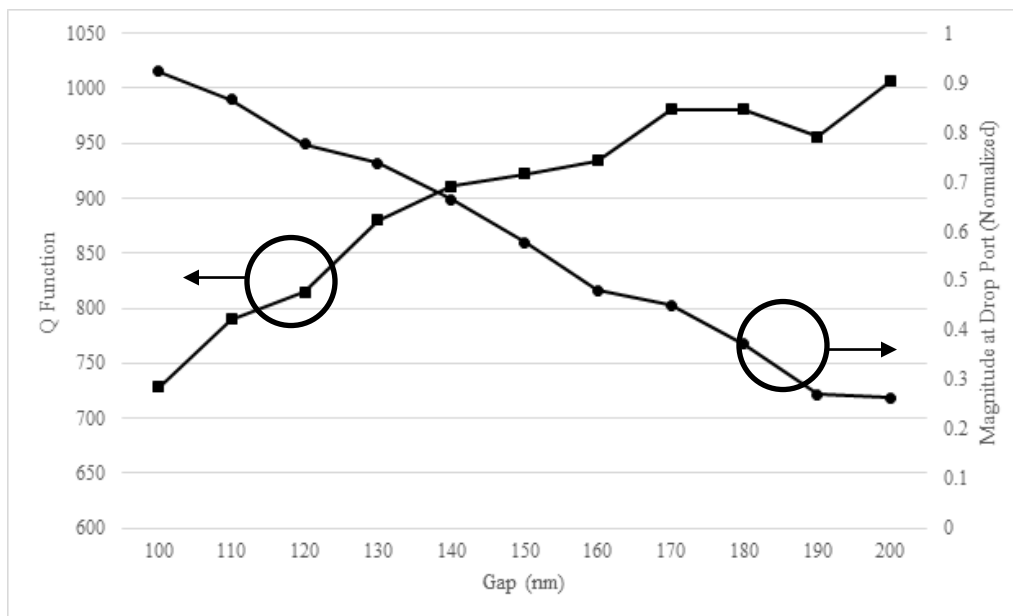


Figure 7. The influence of separation distance (gap) to the Q-factor function and magnitude of transmission response at drop port.

From Figure 7, it can be seen that the value of the Q-factor function is proportional to the gap. The longer the gap, the higher the Q-factor function. However, it can also be seen that the increase in Q-factor function leads to the decrease in the magnitude of the transmission response at drop port. Therefore to achieve a higher value of the Q-factor function, the separation gap should be expanded, but at the same time when gap is kept expanded, the magnitude of the transmission response at drop port is decreasing that cause the decrease in incoming signal to the drop port.

## CONCLUSIONS

The performance of single-mode MRR in which ring resonator waveguide closely coupled to double straight bus waveguides has been predicted using FDTD simulator. Generally, the results of simulation are that Q-factor inversely proportional to the coupling length of the ring waveguide, and proportional to the separation gap. The longer the separation gap the lower the intensity of power transmission response. For sensing application, the best performance of MRR is achieved when there is no coupling length and the gap separation should be around 140 nm.

## REFERENCES

- [1] Chao, C-Y, Fung, W and Guo, L.J. Polymer Microring Resonators for Biochemical Sensing Applications. *IEEE J. of Selected Topics in Quantum Electronics*, 2006; 12(1):134-142
- [2] Fidanboyulu, K and Efendioglu, H.S., "Fiber optic sensors and their applications", Proc of 5th International Advanced Technologies Symposium, Turkey, May 2009.
- [3] Passaro, V. M. N., de Tullio, C., Troia, B., La Notte, M., Giannoccaro, G. and De Leonardis, F. Recent Advances in Integrated Photonic Sensors *Sensors* 2012; 12: 15558-15598
- [4] Manoharan, K. Design and Analysis of High-Q, Amorphous Microring Resonator Sensors for Gaseous and Biological Species Detection, Ph.D thesis, 2009, Ohio University
- [5] Tan, F.S. Integrated Optical Filters Based on Microring Resonators, Ph.D Thesis. Twente; University of Twente, 2004.
- [6] Mulyanti, B, Hariyadi T, Hasanah L, Hazura H, Sahbudin S, Menon PS, Abang AE, Mahmudin D, dan Wiranto G. Design and Optimization of Coupled Microring Resonators (MRRs) in Silicon-on-Insulator, *Journal Sains Malaysiana*, 2014; 43(2): 247-252
- [7] Hazura Haroon, Mardiana Bidin, Hanim Abdul Razak, Menon P S and Arsad N. Impact of Coupled Resonator Geometry on Silicon-on-Insulator Wavelength Filter Characteristics *IEEE Proc. of Regional Symposium on Micro and Nanoelectronics (RSM 2011)*, Kota Kinabalu, 380
- [8] Hazura Haroon, Sahbudin Shaari, Menon P S, Mardiana B, Hanim A R, Arsad N, Majlis B Y, Mukhtar W M and Huda Abdullah Design and characterization of multiple coupled microring based wavelength demultiplexer in silicon-on-insulator (SOI) *Journal of Nonlinear Optical Physics & Materials*, 2012: 21:1250004-1-8
- [9] Shaari S, Hanim A R, Mardiana B, Hazura Haroon and Menon P S Modeling and analysis of lateral doping region translation variation on optical modulator performance the 4th Asian Physics Symposium AIP Conference Proceedings, 2010; 1325: 297
- [10] Elsherbeni, Atef Z. and Veysel Demir, *The Finite-Difference Time-Domain Method for Electromagnetics with MATLAB Simulations*, SciTech Publishing, Inc., Raleigh, 2009.
- [11] Paloczi G T, Huang Y, Yariv A, and Mookherjea S. Polymeric Mach-Zehnder Interferometer Using Serially Coupled Microring Resonators, *Optics Express* 2003; 11(21): 2666-2671.

- [12] Mookherjea, S. Optical Devices for Computing: Modeling Photonic Circuits, Lecture, University of California, San Diego, 2012. DOI: [http://mnp.ucsd.edu/ece241B\\_2012/L7.pdf](http://mnp.ucsd.edu/ece241B_2012/L7.pdf)
- [13] Yee, K. S., "Numerical solution of initial boundary value problems involving Maxwell's equations in isotropic media," IEEE Trans. Antennas Propagat., 1966. Vol. AP-14, 302-307.
- [14] Taflove, A., and M. E. Brodwin, "Numerical solution of steady state electromagnetic scattering problems using the time-dependent Maxwell's equations," IEEE Trans. Microwave Theory Tech., 1975. Vol. 23, 623-630.
- [15] Chu, S. T., and S. K. Chaudhuri. Finite-Difference Time-Domain Method for Optical Waveguide Analysis. Progress in Electromagnetics Research, PIER 11, 1995: 255-300.
- [16] Gedney, Stephen D., *Introduction to the Finite-Difference Time-Domain (FDTD) Method for Electromagnetics*, Morgan & Clay pool, San Rafael, 2011.

# **PEER INTERACTION IN SOCIAL MEDIA FOR IMPROVEMENT OF EAP AND PROBLEM SOLVING SKILLS**

**Mohammed Shamsul Hoque, Md Kabirul Islam**

**Daffodil International University, Dhaka, Bangladesh**

## ***Abstract***

The main aim of this study is to investigate the usefulness of peer-interaction/intervention within the framework of group dynamics online in the improvement of the subjects' EAP and their problem solving skills in undergraduate courses. A social media tool named 'Learning Feedback System (LFS)' was used to offer the course through a blended approach. The students were given a task set on computer programming and asked to support each other for solving problems related to their course topic with no teacher intervention. The frequency of authentic language, academic words and total number of words used in the first and second postings of 79 students was analyzed. The results revealed that the majority of the students participated actively in the task, and the interactions helped solve each others' problems and improve their content knowledge. A sample of 10 students was interviewed for their experience of getting involved in the peer group activities for problem solving, improvement of content knowledge and EAP. The students' perceptions related to the benefits of peer interaction in the social media environment were highly positive.

**Keywords:** EAP (English for Academic Purposes), L1 (First Language/Mother Tongue), L2 (Second Language), ELL (English Language Learner), OER (Online Educational Research), LFS (Learning Feedback System), Content Knowledge, Social Media, Peer Interaction/Intervention.

## **INTRODUCTION**

Social media is a young area of learning in the world. Previous research (Wilson, 2013; Ashley, 2014; Wayne, Cheryl, & Melissa 2014) shows that educational institutions have begun to reflect critically on its use because the social media based platforms can transform teaching and learning into more competitive and relevant. The use of several social media for example, Face book, Twitter, Foursquare etc. have been used in teaching and learning in the recent years in few developed countries to utilize students' motivation for interaction to ensure greater academic success. In the USA, 80 percent of faculty use social media technologies in their courses (Moran et al., 2011). Consequently, these technologies are becoming common features in college and university level education (Wong, 2012).

Islam, M. Islam & Hoque (2014) found that extensive and improper use of social media is the reasons of poor academic performance. They also identified that the students remain busy with the social media during their personal study hours in an unsupervised environment. Studies (Mandviwalla, Schuff, Chacko, & Miller, 2013; Alon, & Herath, 2014) show that Social media offers lot of benefits and hence these technologies can be used effectively in a supervised environment in the classroom. Universities in Bangladesh have been using social media technology for over 10 years now providing extra support to the learners in a blended approach. Since the students are acquainted with the system (LFS), this study aimed to investigate a course offered by the CSE

Department to discern whether peer group interaction occurs for solving problems and to what extent it influenced their level of English for Academic Purpose (EAP) and content knowledge. It has been a great concern for all concerned that most of our university entrants' possess poor level of English skills. Their skills in academic English are even worse. Conversely, our students are not quite familiar with the benefits of peer-interaction/intervention and so, are reluctant to participate in this kind of tasks involving peer-support, peer-checking, peer-teaching using group dynamics. This study focused on those concepts by giving a simple programming task to the students following face to face lessons on the relevant topic.

## **LITERATURE REVIEW**

E-learning has different forms in practice. Despite distance education universities, a huge number of traditional universities in the world have distance education mode of courses and blended learning approach. Although teaching and learning through social media technologies is somewhat different from the Learning Management System (LMS) used for E-learning but teachers and educators have been using these technologies for years in education. Some of their experiences and findings are summarized below.

A recent study conducted by Ashley (2014) commented that social media tools provide many positive uses to the students and found ways to bring it in the classroom for academic conversation. However, the author suggests using the social media during school time may result in more disruption than engagement in learning for the students. The use of such tools can enable higher education to go beyond hierarchical knowledge transmission to interactive knowledge building that establishes connections and increases the flow of learning among students (Mandviwalla, Schuff, Chacko, & Miller, 2013). This new use of social platforms changes student and faculty development, graduate placement, and teaching and learning. Since social media wasn't created specifically for education, teachers must be aware of potential limitations before attempting to use it in their classrooms, although this kind of media may increase communication among students (Wayne, Cheryl, & Melissa 2014). Research has even shown that some students, especially those who are shy, are more likely to contribute to academic discussions if held in an electronic class or online class (Islam, 2003). Peruta, Ryan, & Engelsman, (2013) commented that at a time when universities are facing increasing competition, social media is seen as a new channel of communication between the institution and its constituents - a new way to present its brand to current students, prospective students, parents, faculty members, and community members.

An empirical study conducted by Alon, & Herath, (2014) revealed that social media interaction was both beneficial and positive, and it helped to promote an understanding of the importance of teamwork and the uses of technology. Toetenel (2014) examined the effect the use of the social networking tool in second language learning had on group cohesion and learner-to-learner interaction, and how these, in turn, enhanced informal language learning due to an increase in learner collaboration. The study found that the use of social media enhanced group cohesion and that learners started working in different groups once the social media site was introduced. Finally, it highlights the potential technical and administrative barriers that can impede an institution in implementing its educational strategy in regards to OERs – in this case, social networking sites in the classroom. The further education college in which this study took place had no policies in place in regards to the

use of OERs in the classroom. Thus the author concluded with recommendations with regards to training and policies so that researchers and practitioners can learn from this study. A similar study was conducted by Vasbo, Silseth, & Erstad (2014) where they gained knowledge about what it means to be a learner using social media in an educational setting. The authors present an ethnographic study of students in a multiethnic community who participated in a social networking site called *Space2cre8*. The authors provided a detailed study of how two students made use of this social networking site as part of school activities, and it outlines two specific ways in which to be a learner using social media in school. The findings suggest that a social networking site, such as, *S28* can provide different resources for different students with different learner identities, and might represent a space in which everyday knowledge and school knowledge merge to offer a hybrid space for learning. Another study conducted by Young (2013) in the USA reports that about a quarter of entering freshmen (N=200000) entering four-year colleges said they spent six or more hours a week using online social networks or watching television. At least a quarter (N=19000) have used such online networking for college-related purposes like group study, homework assignments, and obtaining information about campus activities.

The teacher's role is changing in this paradigm as well. The teachers' responsibility is to mediate the learning process and harness the power of social media in the classroom to do so (Powers, Averbek, Alhussain, Warner 2012). These researchers also added, no longer are they (teachers) focused simply on pushing content or information; they are facilitating the process and helping students' presume responsibility for their own learning. So, it appears that the role of the educator is bound to change in the 21st century. Johnson and McElroy (2012) describe the changing role of the teacher in the 21st century as the ability to present core skills and knowledge in a way that is relevant to the students and connects the curriculum to the real world. Feliz, Ricoy, & Feliz (2013) analyzed the use of Twitter in the course Social Media and Digital Learning and recommended that the students needed to be given guidance (by the teachers), insisting on re-tweets, as well as on improving horizontal interaction.

The role of the educator is also supposed to be changed in the 21st century because social media is the best way to take advantage of the personal learning networks that are being developed and to share information and ideas on how to make a difference (Wheeler 2011). Most importantly, social media and *Web 2.0* tools are the enablers that bring the learning community together. However, it is defined by the learner, and provides the framework that allows students and teachers to harness the power of collaborative, personal learning. Social media networks are creating possibilities for learning that did not exist 10 years ago; how we harness these learning communities and create the classrooms of the future that meet the needs of today's learners and society is still emerging. The impact of social media and *Web 2.0* tools, and the potential of the ever evolving technology on distance education are yet to be fully understood but educators must continue to evolve the use of these collaborative tools to ensure that what is being taught is relevant to the learner and can be applied in their real world (Wheeler 2011). Despite the relative novelty of the '*2.0*' versions of learning associated with personal learning environments and social media, aspects of the underlying conception of learning are not necessarily new (Friesen & Lowe, 2012; Menéndez Echavarría, Sánchez, & Claudia, 2013).

### **Summary**

The literature review shows that the social media is a Sophisticated Avenue for engagement of students for their learning in several ways like group study, homework assignments, and obtaining information about campus activities etc. The social media tools can enable higher education to go beyond hierarchical knowledge transmission to interactive knowledge building. However, proper planning and guidance are crucial which are imposed on the teachers to meet the demand of the today's learners. Student collaboration using such social networking tools, in turn, may contribute to second language learning but no authentic evidence has yet been found from the studies. This phenomenon is, as it were, a completely new area to explore in the perspective of Bangladesh. A lot of study presents positive outcomes and encouraging recommendations about the benefits of social media for creating communities of learners. Very few studies have given statistical data of students' interaction and peer-intervention, as yet. The present study may be considered as a pioneering work, specially, in regard to the use of social media in teaching-learning in Bangladesh.

### **METHODOLOGY**

The research was conducted in a university in Dhaka, Bngladesh. The students were familiar with the social media tool called 'Learning Feedback System (LFS)' and had experience of using this tool in a digital environment. The objectives of this study were to:

1. Investigate the level of interaction between students for problem solving
2. Identify the relevance of the postings to the topic/task set given by the teacher
3. Analyze the academic writing skills of the students
4. Identify the improvement of English language skills, specially, writing in both authentic and academic language.

A computer fundamental course was considered for this study. The course was taught by a teacher in a face to face class. The university has a practice to use the Learning Feedback System (LFS) to provide students an extra support for broader understanding of the topic. To comply with the university policy the students registered for the computer fundamental course were instructed to use the *LFS* as desired by the course teacher. The teacher used power point presentations in the face to face lessons as per planning. The objective of the topic taught was to enhance students' knowledge of programming. On completion of the required number of face to face lessons, the students were given a set of tasks in the blog of *LFS* and they were instructed to post a message in response to the task and write their problems that is, what they could not understand. The students were also asked to respond to their fellow students and give solutions to their problems. The students were given two weeks time to complete their group discussion involving peer-interaction. The course teacher did not intervene or support the student for solving their problems.

This study focused on three sections of the course. Section A, B and C comprised 28, 23, and 28 students respectively. There were few female students in each section. All textual message postings of the students were collected in both soft and hard copy forms. Frequency of the postings of each of the total 79 students were counted and there pattern of posting was analyzed. All postings were read carefully to analyze academic writing skills of the students. Total number of words and the content words in the first and the second postings were counted. The first posting was the statement of the problem that the students faced to solve the task and the



second or the third, (and the fourth in some cases,) postings were a response to a particular student or the whole group to solve individual problems or to answer specific questions.

The quantitative analyses of the total number of words and content words of each posting were done for each of the subjects in all of the three sections (A, B & C) separately, and graphs were produced using Excel. Small sample of 10 students were interviewed to know their perceptions of peer group interactions in social media.

## **FINDINGS**

### ***Frequency of posting***

The data of the subjects' postings in the Learning Feedback System shows that few (Table 1) students in each section posted only one message to share their problems in understanding the programming task. Most of the students in each section posted more than one message, that is, they stated their problems in the first posting and helped others in understanding the task by posting second and third messages. The frequency of message posting of the students is presented in table 1.

Table 1. Frequency of message postings by three sections in LFS

Section	No of students	No of 1 <sup>st</sup> posting	No of 2 <sup>nd</sup> posting	No of 3 <sup>rd</sup> plus 4 <sup>th</sup> posting	Total
A	28	28	22	11+4	65
B	23	23	20	5+0	48
C	28	28	24	1+0	53
Total	79	79	66	21	166

Section A, B and C posted a total of 166 messages. Of these messages 52% were posted for solving each others' problems. In doing so, students applied their knowledge and skills in programming. Students belong to section A posted more messages than the other two sections. In addition to 22 second posting 11 students of section A posted a third message and four of them posted a fourth message for assisting a particular student for understanding the solution to the task set. This section was more interactive than the other two sections. Pattern of posting of section B and C is similar. Third attempt of those two groups was sporadic. None of them has a fourth posting. The data shows that out of 79 students, only 13 students were not able to respond to their fellow students for solving problems. However, they received help from the others.

### ***Problem solving ability***

This section presents the data of the statement of the problems related to the task set and the responses corresponding to the problems. The total number of words of the first and second posting made by the students belong to section A is shown in figure 1.

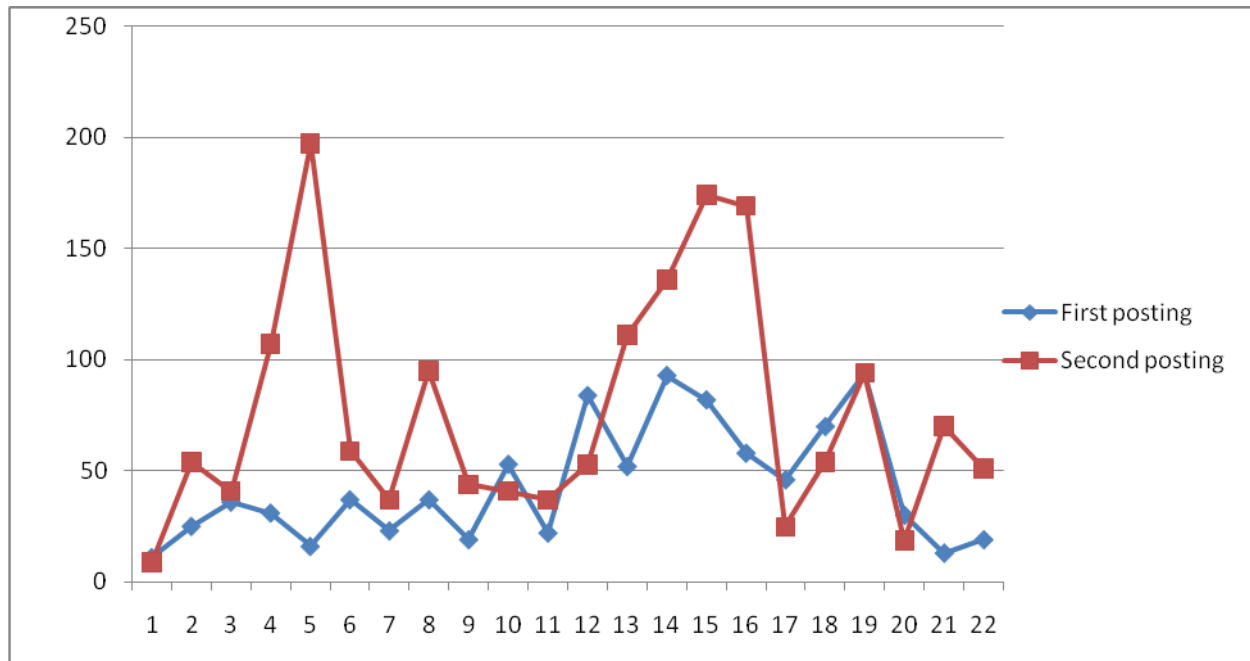


Figure 1. Total number of words in first and second posting of 22 students of section A

22 Students of section A came up with a second posting to meet the queries and assist for solving problems of their fellow students. Figure 1 indicates that the second posting was longer than the first posting of the students except a very few. The posting were basically related to computer programming, indicates certain level of content knowledge and problem solving capacity of the students. Examples of interactions are given below.

**Transcript of first posting of students no 7 of section A:**

1. Why -2 will not appear in the output screen?
2. What is the correct program?

**Transcript of second posting of student no 9 of section A, who replied to student no 7:**

*First ans: -2 will not appear in the output screen because a student add three pair's of number & all time output screen shows which pair of number shows 'yes' -2 never shows cause -2 shows 'no'.*

**Transcript of second posting of student no 10 who also replied to students no 7:**

1. A student wants to add **THREE** pairs of numbers shown in the **DATA** statements using the program above. Write the output that **should** appear in the box on the right.
2. To check the program line-by-line a table with all the variables and conditions in the program needs to be prepared. In the table below, add the variables and conditions that you would need to check in each line
3. As the program is executed, write the value of the variables and the output from the conditions for each line in the trace table

**Transcript of second posting of student no 11 who replied to students no 7 for more feedback:**

*What is the correct problem?*

*Ans: in the given program the incorrect line is 30.If we remove this line from the program and add that line in line 50, then it will be correct and give us the right output. So, the correct program isPage 6*

In the above example of student's interaction, problems of student 7 were addressed by the three students in various ways to make him understand the task. The responses of the students were straightforward and relevant to the problems of student no 7 which may indicate that they have problem solving ability. Without knowledge of programming they could not answer to the questions asked by student no 7.

Among 23 students of section B, 19 students posted a second message in response to their peers. These second postings were relevant to the question asked by the group members. The graph of the total words of the first and second postings is given in figure 2.

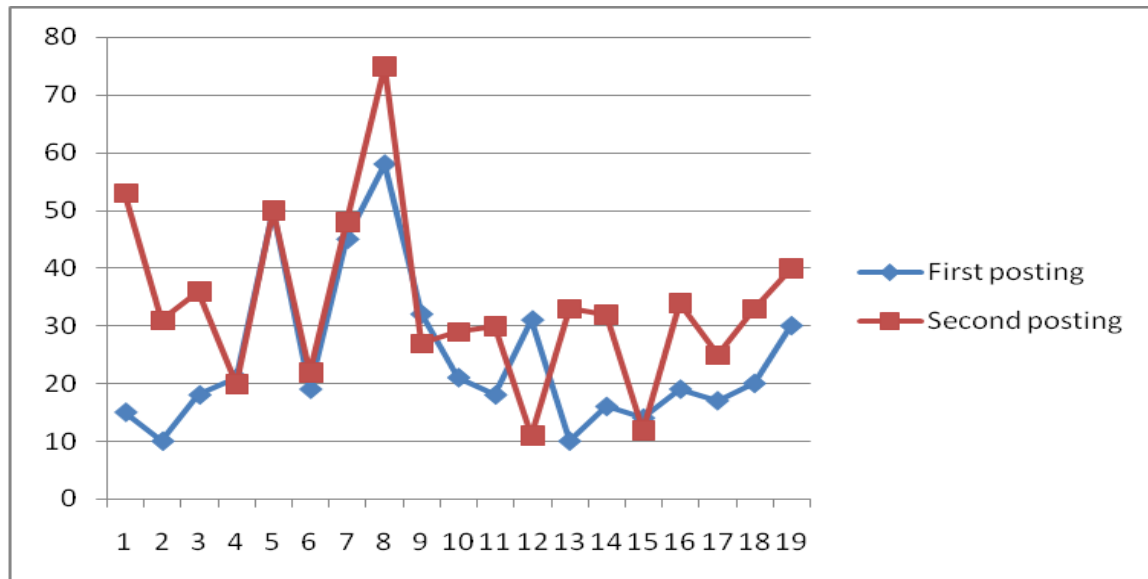


Figure 2. Total words of the first and the second posting of 19 students of section B

The pattern of total words in the first and second posting of section B is similar to that in section A. The postings of a few numbers contained around 10 words and others posted longer messages. An example of student interaction of section B is given below.

**Transcript of first posting of students no 1 of section B:**

*Problem 1: What is the mean by M1<>-1?*

*Problem 2: For what output screens 13 add?*

**Transcript of second posting of student no 7 of section B, who replied to student no 1:**

*Problem 1: What is the mean by M1 <>-1?*

*1st answer.... It is a while and wend programming its means input m1 never been equal input -1..*

*Problem 2: For what output screen 13 add?*

*2<sup>nd</sup> answer... friend in this programme screen output m3=13 add only for input m1+m2(5+8)...*

In the above interactions, the responses of student 7 were relevant to the questions asked by the students 1. Student 7 confidently guided his/her fellow students for understanding the teacher's tasks.

Out of 28 members of section C 23 posted messages for responding to their peers. Word count of most of the second postings was substantial compared to their first posting (figure 3).

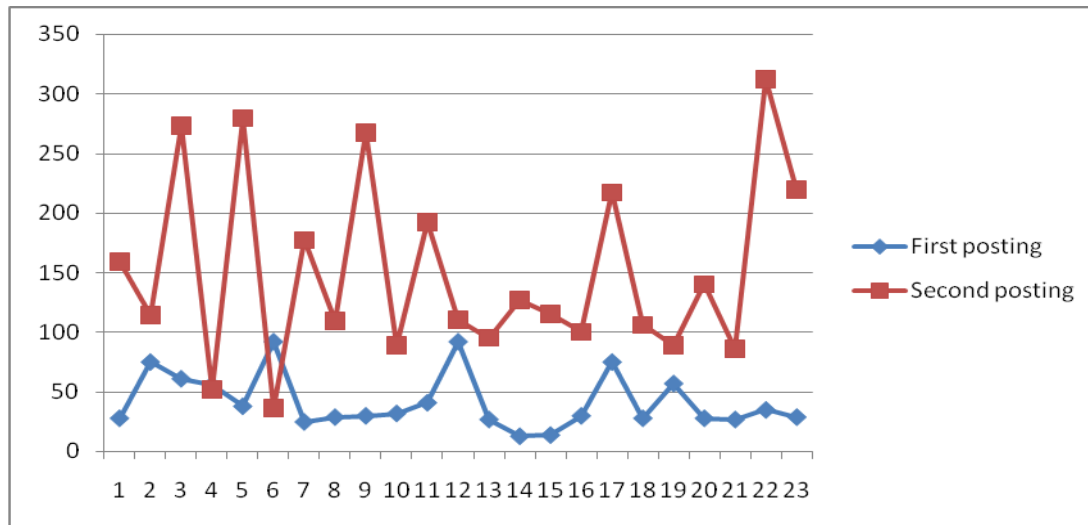


Figure 2. Total words of first and second posting of 23 students of section C

Despite long responses, some students of section C gave explanation of their problems related to the task set. An example of student interaction of this section is given below.

#### First posting of students 13 of section C:

1. I do understand trace table program but when I input data 5, 8 and I have no output in this program. I know that the right program output 13. But I do not understand where I have write 13 in trace table program.
2. In the part of screen output of the answer I did not write. In this program I have some output is 23,32,-2 but I do the right program and I have some output 13,23,32. I did not know what should write in the screen output.

#### Second posting of student 12 of section C:

1. some of my friends question is why we circular 2 in the trace table  
**Solution:** in the given question if we see the question no 4 we can see that their instruction is two circular the incorrect output. In the other hand we know that if we give any negative date to the computer the computer will stop its work because computer never take any negative date and in the question paper. We can see that M1 so here -2 is incorrect output and for this reason we circle 2
2. One of my friends question is he was confused about what he will write in the output serene? Was it the given program output or the correct program output?

**Solution:** of course we will have to give the correct program output. Because in the question no 5. We can see that we have to solve the correct program on the revise side of that question paper to give the correct output and if needed we may remember the program line. So by solving the correct program we get the correct output. For this reason we have to write the correct output to the screen output.

The above interaction of section C shows that the pattern of questions asked and the responses is somewhat different from the other two sections. In the above example, student 13 gave explanation of the task and then asked questions what he/she could not understand. Similarly, student 12 explained the task different ways and provided solutions to the questions.

The summary of results in the above two sections suggest that the level of interaction was low but it fulfilled their course requirement designed by the teacher and guided for understanding the task. The interview data of the students supported this finding. The students of the three groups perceived that the peer group interaction was so helpful for improvement of the content knowledge.

### ***English for Academic Purpose (EAP)***

#### ***Use of Language Skills***

Only three out of a total of 79 students have shown competence in their use of the rules of basic grammar and content vocabulary with good comprehension. These three students have made appropriate and effective peer intervention with good explanation and instructions for those asking for support and those quietly needing it. Examples are given below. Student no 2 of section A responding to student no 23: *“As the program is executed, write the value of the variables and the output from the conditions for each line in the trace table.”* Student no 6 of section A explaining problems to student no 26: *“Suppose, you want to add first 3 two pairs, then anything else than these 3 will be wrong. It will be wrong again if it comes in wrong order. LIKE, you want output A,B,C. the Other outputs are wrong and A must be at first place, B at 2<sup>nd</sup> and C at 3<sup>rd</sup>. if B becomes 1<sup>st</sup> then this B is wrong and such C at 2<sup>nd</sup> position will be wrong. So, Out must be the same as expected other will be wrong, And it must be as expected order. Otherwise it is wrong.”*

#### ***Difficulty in understanding questions***

Except only three students, all in the three sections failed to understand the questions adequately. One of the reasons of difficulty in understanding the questions may have been a deliberate action on the part of the teacher setting the task. Their understanding of the contents words is extremely poor as well. The words like *“executed”, “wend”, “appear”, “data Statement”, “program above”* were mentioned by many to be explained or even translated in Bangla.

#### ***Use of L1, Bangla***

Interestingly, in section A, nine posts were made in Bangla using both Bengali and English scripts. Two participants asked for translation of the problems or solutions in Bangla, their L1, and they commented that they would understand the quiz and the content better through Bangla. The level of English in this group may be lower on an average from the other two sections. An examples of the use of L1, Bangla is *“problem a **amra** computer **k** read **korbo**”*. Here the words in bold are used in the subject’s L1. Other 3 words are in English. Another example, *“tokhon computer-e <>-l check korio”* which is absolutely in Bangla.

## **DISCUSSION**

In the first instance, it appears from the design of the course that the teacher sought to involve students in problem solving through interaction and intervention by giving them a task set on computer programming. Teacher intervention was withdrawn to allow authenticity of students’ participation and ensure the use of authentic language on the part of the subjects. Hence, no intervention of the teacher was found in the social media discussion blog. The level of interaction between students for problem solving and helping each other for understanding the tasks would indicate the achievement of the course goals (Islam & Vale, 2012). The course teacher might recognize him/her as successful but he/she must be aware of the potential limitations of the students (Wayne, Cheryl, & Melissa 2014) before attempting to use them for solving the given problems and provide guidance for a common understanding. Moreover, teacher’s contribution enhances confidence level of the students.

The frequency of message posting appears satisfactory as the students were asked to state their problems and provide solutions to each others’ problems. All 79 students posted their levels of difficulties in understanding the task set. A few students of section C explained the task and then indicated their problems that they were facing. In fact, a few students, only three, showed confidence in dealing with the task set. Except a very few in

each section, most students came up with explanation of the problems and solutions to them with justifications and was seen to be useful for understanding the problem. The interaction activities show that the students had access to the task set (Islam & Vale, 2012) to a considerable extent and achieved the skills of using the content knowledge at an expected level after discussion. This kind of group dynamic in asynchronous environment (Cox, & Cox, 2008) and interactive knowledge building establish active networking connections and increases the flow of learning among students (Mandviwalla, Schuff, Chacko, & Miller, 2013). Student interaction occurred in the groups had a positive impact but they had lack of social skills as the participants did not acknowledge each others' help during interaction.

English language is used as a medium of instruction especially in higher education worldwide (Doiz, Lasagabaster & Sierra, 2013) but it is a challenge for those learners who use it as a second language (L2). Previous study (Toetenel, 2014) found that social networking tool supported learner-to-learner interaction, and in turn, enhanced informal language learning, especially, a second language, due to an increase in learner collaboration (Pasfield-Neofitou, 2012). This finding is contradictory to the present study as majority of the students exhibited poor level of Academic Writing Skills in English while communicating their problems or giving solutions to the problems. The students had lack of skills in using rules of grammars and appropriate vocabulary. Indeed, they did not pay attention to their writing skill and attempted to communicate some times in their L1, Bangla (mother language), on several occasions by few students. However, the use of L1 (mother tongue of the ELLs) can be very helpful in the beginning of SLA (Second-Language Acquisition (Krashen and Brown, 2007).

## CONCLUSION

In the context of a developing country and involving a group of students with Non-English speaking background, this study is so important for broader understanding of overall learning behavior of the students as well as their level of English language skills. The study shows that the course teacher had insufficient strategies for involving students in problem-solving activities in an online setting like social media tool named Learning Feedback System. There are some positive impacts in understanding the topic/ tasks through peer group interactions and it enhanced students' level of content knowledge and problem solving skills. Teacher intervention is an effective strategy in a teaching-learning situation. The planned withdrawal of teacher interventions in this study might have influenced the outcome and learner achievement. So, recommendation may be made for any replication of such peer intervention program in future as teacher interventions, even in the form of a simple encouraging comment and acknowledgement do boost up learner engagement and hence, increased achievement. Content analysis of the available data, students' postings in this case, which has not been done elaborately in this study, is an important technique to interpret impact of peer interaction in such studies. Inclusion of detailed content analysis is recommended for further studies to ensure more credible findings.

## REFERENCES

- Alon, I., & Herath, R. K. (2014). Teaching International Business via Social Media Projects, *Journal of Teaching in International Business*, 25 (1), 44-59.
- Ashley, H. (2014). Don't Get Trapped by Social Media, *Education Digest*, 79 (9), 32-36.
- Cox, B. & Cox, Be. (2008). Developing Interpersonal and Group Dynamics through Asynchronous Threaded Discussion: The use of Discussion Board in Collaborative Learning, *Education*, 128 (4), 553-565.
- Doiz, A. Lasagabaster, D. & Sierra, J. M. (2013). *English-Medium Instructions at Universities: Global Challenges*, Eds, Aintzane, D. David, L., & Juan, M. S. Multilingual Matters, NY, USA.

Friesen, N. & Lowe, S. (2012). The questionable promise of social media for education: connective learning and the commercial imperative, 'Journal of Computer Assisted Learning', 28 (3), 183-194.

Feliz, T., Ricoy, C., & Feliz, S. (2013). Analysis of the use of Twitter as a learning strategy in Master's Studies, 'Open Learning', 28 (3), 201-215.

Islam, M. K. (2003). *A Case Study of Student Interaction in Online Discussion*, PhD Thesis, Victoria University, Melbourne, Australia.

Islam, M. K. & Vale, C. (2012). The Teacher's Role in Promoting Online Peer group Learning, 'International Journal of Information and Communication Technology Research', 2 (1), January.

Islam, M. K. Islam, Y. M, Hoque, M. S., (2014). Poor Academic Performance of University Students: Problems and Solutions, *ULAB Journal of Science and Technology*, Vol. 5 November 2014, 18-25.

Islam, M. K. & Hossain, M. F. (2012). Online Vs. Traditional Shopping in Bangladesh, *DIU Journal of Business*, Volume 6, Issue 1.

Johnson, B., & McElroy, T. M. (2012). The changing role of the teacher in the 21st century, Retrieved from <http://teachers.net/gazette/wordpress/dr-brad-johnson-tammy-maxson-mcelroy/changing-role-of-the-teacher/3/>

Krashen, S., and Brown, C.L.,(2007) : What is Academic Language Proficiency? *University of Tennessee*  
Retrieved from: [www.joanwink.com/newsletter/2007/Krashen-Brown-ALP.pdf](http://www.joanwink.com/newsletter/2007/Krashen-Brown-ALP.pdf) on 02/01/2015

Menéndez Echavarría, A. L., Sánchez H., Claudia M. (2013), Using Social Media Platforms in University Teaching Practice: Biographical-Narrative Research in a Case Study, 'Signo y Pensamiento', 32 (63), 152-168.

Mandviwalla, M., Schuff, D., j Chacko, M., & l Miller. L. (2013). Is That All There Is? Taking Education to New Levels in the Social Media Era, 'Change', 45 (5), 51-58.

Moran, M., Seaman, J., & Tinti-Kane, H. (2011). Teaching, learning, and sharing: How today's higher education faculty use social media, 'Boston, MA: Pearson Learning Solutions', Retrieved from <http://www.pearsonlearningsolutions.com/educators/pearson-social-media-survey-2011-bw.pdf>

Peruta, A. Ryan, W. & Engelsman, R. (2013). Social Media Branding Strategies for Higher Education: Comparing Facebook Pages and Web Sites, 'International Journal of Technology, Knowledge & Society', 9 (1), 11-23.

Powers, L., Averbeck, C., Alhussain, R., Warner, A. (2012). Perspectives on Distance Education and Social Media, 'Quarterly Review of Distance Education', 13 (4), 241-245.

Pasfield-Neofitou, S. E. (2012). *Online Communication in a Second Language*, Multimedia Matters, NY, USA.

Toeteneel, L. (2014), Social Networking: A Collaborative Open Education Resource, 'Computer Aided Language Learning', 27 (2), 149-162.

Vasbo, K. B., Silseth, K., & Erstad, O. (2014), Being a Learner Using Social Media in School: The Case of Space2cre8, 'Scandinavian Journal of Educational Research', 58 (1), 110-126.

Wheeler, S. (2011). Digital age learning, Retrieved from <http://steve-wheeler.blogspot.com/2011/07/digital-age-learning.html#!2011/07/digital-age-learning.htm>

Wayne, J., Cheryl, A. A, & Melissa W. B. (2014). Twitting in the Classroom, 'Phi Delta Kappan', 95 ( 5), 63-67.

Wilson, C. D. (2013). Making Connections: Higher Education Meets Social Media, '*Change*' 45 (4), 51-57.

Wong, W. (2012). Colleges go proactive with flipped classrooms. '*EdTech Magazine*', Retrieved from <http://www.edtechmagazine.com/higher/article/2012/08/colleges-go-proactive-flipped-classrooms>

Young, J. R. (2013). In a Time of Experimentation: Excitement and Dread, '*Chronicle of Higher Education*', 59(46), 60-64.



# Development of Pre-treatment Process for Aceh Low-rank Coal by Simultaneously Capture of Sulfur and Trace Element

<sup>1</sup>Alhamidi Yusran, <sup>2</sup>M. Dani Supardan & <sup>3</sup>Mahidin

<sup>1</sup>Graduate Program of Chemical Engineering, Syiah Kuala University, Banda Aceh  
alhamidi@pim.co.id, +62 812 69 65059

<sup>2</sup>Department of Chemical Engineering, Syiah Kuala University, Banda Aceh  
m.dani.supardan@che.unsyiah.ac.id, +62 813 60 699722

<sup>3</sup>Department of Chemical Engineering, Syiah Kuala University, Banda Aceh  
mahidin@unsyiah.ac.id, +62 812 69 122570 (Corresponding author)

## Abstract

Low-rank coal is a potential fuel for power plant, both for gas and steam turbine systems. Since the low-rank coal contain high fraction of sulfur and some trace metals, therefore burning of that coal will release SO<sub>2</sub> emission in flue gas and trace element particulates in fly ash. In order to suppress the SO<sub>2</sub> emission in flue and trace element (especially Hg) in fly ash, pulverized coal was mixed with bentonite (as desulfurizer and adsorbent) before subjected to furnace or burner. Introduce of bentonite hopefully can capture the sulfur compound (both in form of SO<sub>2</sub> and S) and trace element particularly mercury (Hg). Experimental was performed at desulfurizer/adsorbent content of 0, 2, 4, 6, 8, 10, 12, 14 and 16% (by weight) and burning temperature of 700, 800 and 900 °C. The 20 gr sample of coal-bentonite mixture with particle sizes -60/pan was put in the ceramic boat then placed in the Electric Tube Furnace. Air flow rate was fixed at 1.5λ (λ = stoichiometric air consumption) and reaction was run for 30 minutes. Sulfur and Hg retentions in bottom ash were analyzed using Spectrophotometer and AAS, respectively. It was found that the addition of bentonite can increase S and Hg retention in bottom ash. Maximum adsorption capacity of S and Hg was observed at bentonite dosage of 16% and combustion temperature of 700 °C. Adsorption efficiency for S reached up to 63.5%, while for Hg was 57.2%.

**Keywords:** Aceh low-rank coal; adsorbent; bentonite; bottom ash; desulfurizer; fly ash; SO<sub>2</sub> emission; traces element.

## 1 Introduction

Use of low-rank coal as a fuel in power plant restricted by some factors such as release the GHGs emissions, particulates and trace elements that bring serious environmental problems. Many technologies have been developed and many researches have been attempted in order to reduce the problems. However, nowadays the research and development (R&D) on the technologies are generally focused on those issues done separately, not simultaneously. For example, flue gas desulfurization (FGD) system can only be used to capture the SO<sub>x</sub> emission or flue gas re-burning technologies that only possible to handle NO<sub>x</sub> emission or co-combustion of coal-biomass technologies, which are addressed to solve the problems triggered by CO, CO<sub>2</sub> and N<sub>2</sub>O emissions. First generation for the calcium-based scrubber (a type of FGD) was made in Great Britain in 1920.

Only a few literature can be found study about simultaneous reduction of the SO<sub>x</sub> emission (or other sulfur compounds) and trace elements (or trace metals), especially mercury (Hg) [Ma et al., 2014; Wang et al., 2013]. They applied iron-based sorbents in their investigations. On the other hand, the R&D on the desulfurization technologies using several adsorbents or desulfurizers can be found anywhere [Cheng et al., 2003; Zhou et al., 2001]. Moreover, similar fact might be faced for R&D on the mercury capture by some adsorbents, including bentonite (both natural and treated/modified) [Li et al., 2014]. There is no, at the moment, observation on the simultaneous adsorption of the SO<sub>x</sub> emission and trace mercury using bentonite adsorbent.

Bentonite is an absorbent aluminum phyllosilicate, impure clay consisting mostly of montmorillonite, a clay mineral of the smectite group [Bergaya & Lagaly, 2013; Williams et al., 2009]. The absorbent clay was given the name bentonite by Wilbur C. Knight in 1898. There are different types of bentonite,

each named are respective to dominant element, such as potassium (K), sodium (Na), calcium (Ca), and aluminum (Al) [Borrelli et al., 2013]. Ca-bentonite is the most prevalent of the smectite and is found in many geographical regions in the world. Na-bentonite is relatively rare compared to Ca-bentonite, and it swells more in water than calcium bentonite [Murray, 2006; Fu & Chung, 2011].

Bentonite usually forms from weathering of volcanic ash, most often in the presence of water. For industrial purposes, two main classes of bentonite exist: Na- and Ca-bentonite, which is widely used as a thickener and extender for paints, as an additive in ceramics. The material also applied in producing the health products, cosmetics, foods and pharmaceuticals. However, each of these applications requires specific properties and characteristics of the material [Viseras et al., 2010; Allo & Murray, 2004]. The main uses of bentonite are for drilling mud, binder (e.g. foundry-sand bond, iron ore pelletizer), purifier, absorbent (e.g. pet litter), and as a groundwater barrier.

Chemical contents of natural bentonite mostly comprises of SiO<sub>2</sub>, Al<sub>2</sub>O<sub>3</sub>, MgO, Fe<sub>2</sub>O<sub>2</sub>, CaO, Na<sub>2</sub>O, K<sub>2</sub>O, TiO<sub>2</sub>, P<sub>2</sub>O<sub>5</sub>, MnO, etc. What compound is dominant depend on region from where the bentonite come from [Arbaoui & Boucherit, 2014; Guerra et al., 2013]. The characteristics of bentonite are influenced by the number of smectite and by the exchangeable cations present in the interlayer space [Hanuláková et al., 2013]. Cation exchange (such as Na in, Ca out) increases the distance between the layers structures of bentonite, this allowing for entrance of the water [Barbanti et al., 1997]. High content of SiO<sub>2</sub> and Al<sub>2</sub>O<sub>3</sub>, with small contents of other oxides, was observed in the natural bentonite sample [Akpomie & Dawodu, 2015; Li et al., 2014]. Scanning electron microscopy (SEM) of bentonite shows individual particles that are irregular platelets and tend to form thick and large agglomerates [Nones et al., 2015].

The paper discussed the possibility utilize of natural bentonite for an adsorbent in the low-rank coal combustion for capturing the sulfur and mercury simultaneously. Effect of adsorbent content in coal sample at several burning temperatures is presented here in order to give an evident role of the adsorbent in the proposed work.

## 2 Materials and Method

Materials used in the study were coal (low-rank coal from West Aceh), natural bentonite (from Lampung) and strong acid such as HCl and H<sub>2</sub>SO<sub>4</sub>. Sulfur and mercury contents in the raw coal were 87 and 320 ppm, respectively, whereas chemical composition of the bentonite in this research are (by weight): SiO<sub>2</sub> 47.78%, Fe<sub>2</sub>O<sub>3</sub> 2.49%, Al<sub>2</sub>O<sub>3</sub> 9.11%, CaO 5.09% and the rest are some others compounds such as MgO, Na<sub>2</sub>O, K<sub>2</sub>O, TiO<sub>2</sub>, P<sub>2</sub>O<sub>5</sub>, MnO, and so forth with the contents <1%. Those all chemical contents were slightly lower compared to the Na-bentonite used by Li et al. [13] and Akpomie & Dawodu [1] in their investigation. Moreover, equipment needed were crusher, ball mill, vibrating screen, compressor, electric tube furnace, ceramic boat, clay boat, Atomic Absorption Spectrophotometer (AAS), Spectrophotometer, desiccator, flow meter, electric balance, etc.

The coal and bentonite at first separately crushed and pulverized to have a particle size -60/pan mesh. Those materials then homogeneously mixed before burned at several contents of bentonite (i.e. 0, 2, 4, 6, 8, 10, 12, 14 and 16% by weight, respectively). After that, 20 gram of the coal and bentonite mixture sample put in the ceramic boat and further placed in the electric tube furnace. The samples therefore were burned at temperature of 700, 800 and 900 °C, respectively for 30 minutes with air flow rate 1.5λ liter/minute (λ is stoichiometric air flow rate) [Yao & Naruse, 2005]. Since the combustion temperature relatively higher, there was no calcination treatment applied to the bentonite before utilized. This idea was also supported by the fact that bentonite might be calcined at lower temperature up to 300 °C [Li et al., 2014].

Sulfur and mercury contents in the raw coal and bottom ash samples were analyzed by Spectrophotometer and AAS, respectively. Pulverized raw coal and bottom ash stored in desiccator for analysis purpose. It should be note that the bentonite-captured S and Hg were retained in bottom ash, while the un-captured S and Hg were emitted in the fly ash The measured data were used to evaluate the adsorption efficiency both for mercury and sulfur by the following equation:

$$\eta = \frac{C_i(a = n) - C_i(a = 0)}{C_i(\text{in coal})} \times 100\% \quad (1)$$

### 3 Result and Discussion

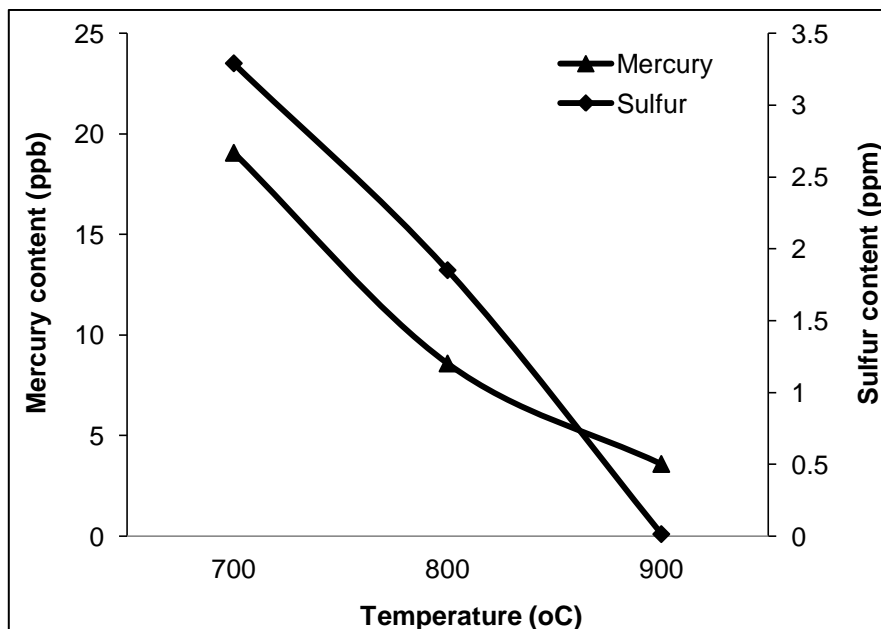
In this section the data and discussions are provided in three sub-section on preliminary test, effect of bentonite addition on the mercury and sulfur contents in the bottom ash and adsorption efficiency, respectively.

#### 3.1 Preliminary observation

Coal combustion generally produced fly and bottom ashes as by product or solid waste. Vaporized trace metals in the coal combustion will partly be suspended in the fly ash and some of un-vaporized will be retained in the bottom ash. Meanwhile, most organic sulfur and pyrite were oxidized and released together in the flue gas, and small part of the sulfur might be captured by the alkaline components of coal ash such as CaO, MgO, Al<sub>2</sub>O<sub>3</sub>, Fe<sub>2</sub>O<sub>2</sub>, Na<sub>2</sub>O, K<sub>2</sub>O and remained in the bottom ash. It was found that the alkaline sulfates were dominant at lower temperature under oxidizing conditions [Yan et al., 1999]. Therefore, based on those finding it is expected that those trace elements and sulfur have high tendency to go down to the bottom ash. It is well known that the bottom ash is more easy to handle compared to the fly ash. In order to increase the possibility of those elements or compounds to be retained in the bottom ash, introduce of bentonite in the coal combustion was conducted in this examination.

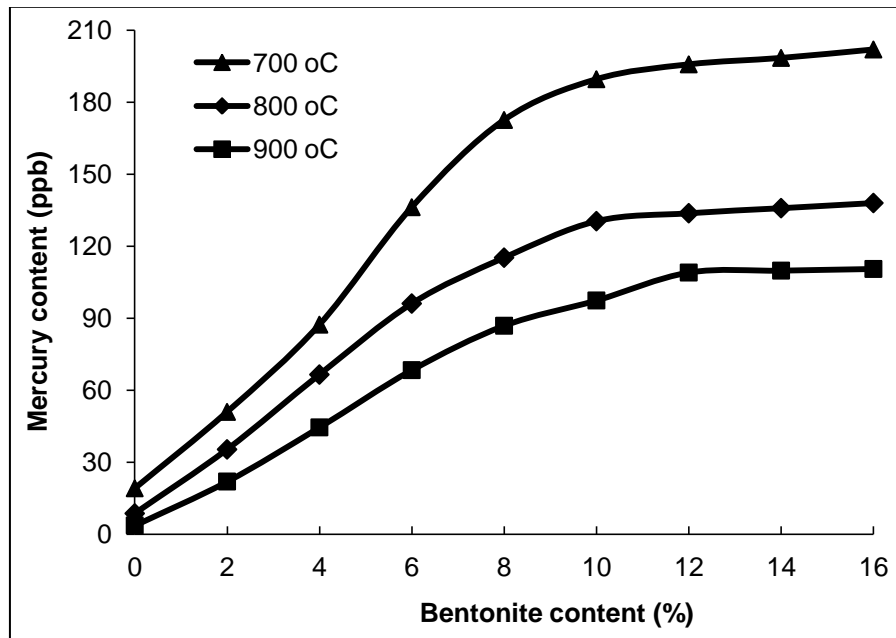
Figure 1 shows the effect of combustion temperature on the Hg and S contents in the bottom ash. The Hg and S contents sharply decreased in regards the increase of temperature. Experimental temperature in this study was fixed in the range of 700-900 °C that was almost same to the Fluidized Bed Combustion (FBB) operating condition [Manninen et al., 1996]. Since the boiling points of Hg and S (i.e. 356.7 and 444.6 °C, respectively) were much lower than operating conditions, that the reason why those elements greatly tended to vaporize in higher temperature. Even though mercury has high volatility, it was still existed in the bottom ash at temperature of 900 °C. That phenomenon might be exhibited by the particulate-bounded mercury (Hgp) from the un-burned carbon in the bottom ash [Wilcox et al., 2012].

Thermodynamic calculations have shown that Hg completely volatilized in the range of FBC operating temperature [Manninen et al., 1996]. However, in this investigation the fact departed from the calculation. The interesting phenomenon was reflected at the interval temperature of 850 to 900 °C; the S curve crossed the Hg curve, it described that the S vaporization rate much higher than that of the Hg vaporization rate in that range of temperature. The different evidence was presented by S element, in which totally vaporized at the higher temperature of 900 °C (or no S content in the bottom ash). Since the existence of S in the bottom ash significantly affected by temperature, it might be said that the Aceh low-rank coal mostly contains inorganic S [Xu & Kumagai, 2003].

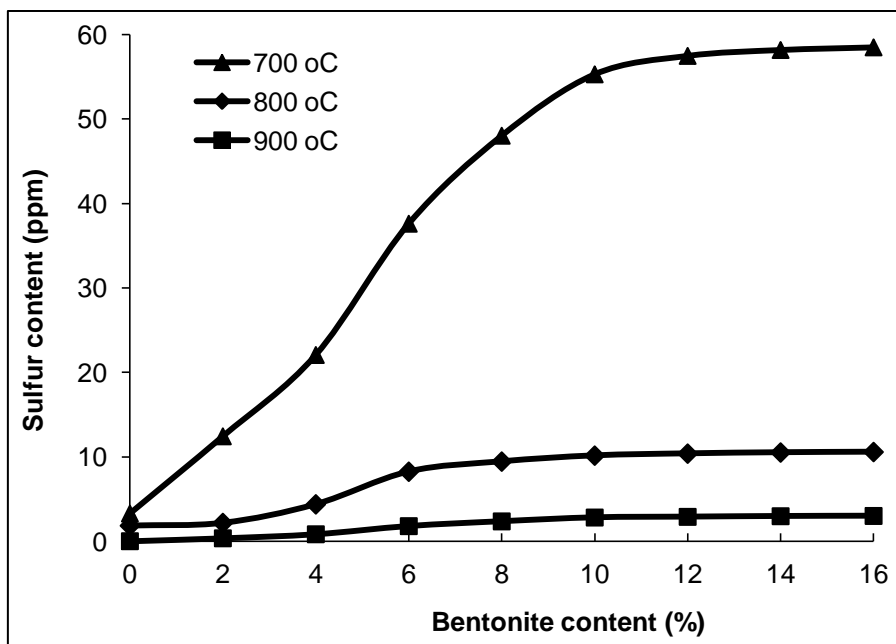


**Figure 1** Mercury and sulfur contents in the bootom ash before mixed with bentonite  
**3.2 Effect of bentonite addition on the mercury and sulfur contents in the bottom ash**

As was mentioned above, addition of the bentonite was addressed to reduce Hg and S contents in the fly ash and flue gas. It is expected by introduce the bentonite as an adsorbent might promoted the affinity or bounding force between the trace metals (Hg) and mineral in the bentonite through the adsorption mechanism and simultaneously lowered the affinity of Hg on S or SO<sub>2</sub> [Huang et al., 2004]. In coal combustion, Hg is possible to react with S or SO<sub>2</sub> to form HgS, and then suspended in the flue gas. In case of S, that attempting enhanced the possibility for inorganic S such as pyrite, marcasite, sulfates and also organic S such as mercaptans, aliphatic and aryl sulfides (even exist in small amount) to be bounded by the alkaline components of bentonite and coal ash, henceforth settled down to the bottom ash. As was proved by Yan et al. [23] that the alkaline sulfates were dominant at lower temperature, it was the reason why S content in the bottom ash higher at temperature of 700 °C because this is the lowest temperature in the examination.



**Figure 2** Mercury content in the bootom ash after introducing the bentonite



**Figure 3** Sulfur content in the bottom ash after introducing the bentonite

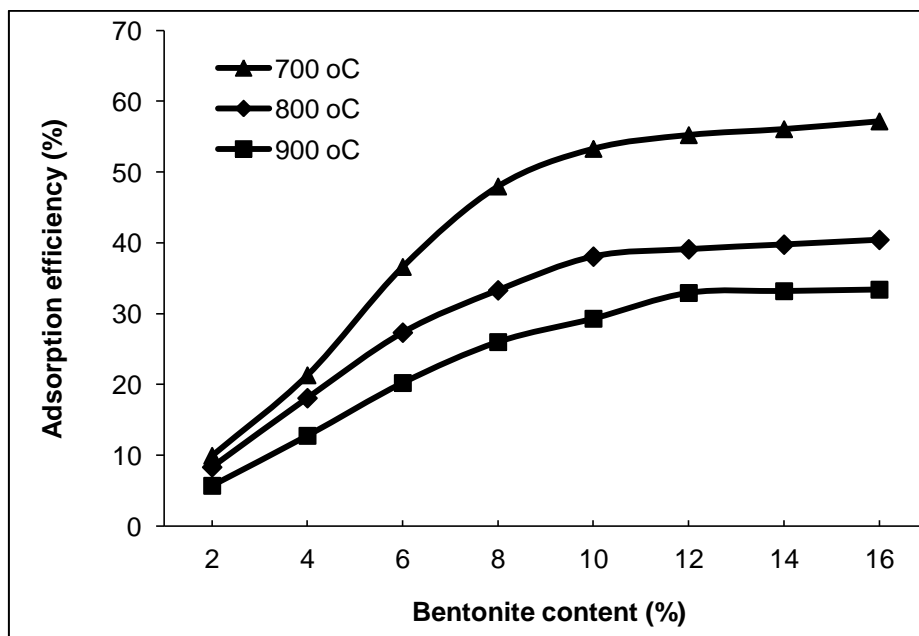
Profiles of Hg and S concentration in the bottom ash are presented in Fig. 2 and 3. It is seen from the figures that the Hg and S concentrations in the bottom ash rise by enhance the bentonite content in the fuel mixture, but it decreased by improvement the burning temperature. The greater concentrations were obtained at the bentonite dosage of 16% and temperature of 700 °C, and the sharp increase also appeared at the same temperature but in the range of bentonite content 0 to 10%. At higher temperature (in this investigation  $\geq 800$  °C) Hg and S concentrations in the bottom ash were small, due to desorption process might taken place at elevated temperature. Moreover, It was observed S was mostly turned into SO<sub>2</sub> gas, less than 10% was retained in the fly ash and less than 1% was held in the bottom ash. On the other hand, about 60% of the calcium was retained in the fly ash and less than 10% was found in the bottom ash [Cheng et al., 2003].

Since the alkaline compounds in this applied bentonite were minor, the effectiveness in the SO<sub>2</sub> capturing was low. Those two facts (desorption phenomenon and low alkalines contents in the adsorbent) influenced the presence of S in the bottom ash in double especially at higher temperature, as can be seen in Fig. 2 and 3 where the curves for S at 800 and 900 °C, respectively much flat compared to the Hg curves ones. Based on the finding data, it might be claimed that the retention of S in any form remarkably controlled by physical adsorption.

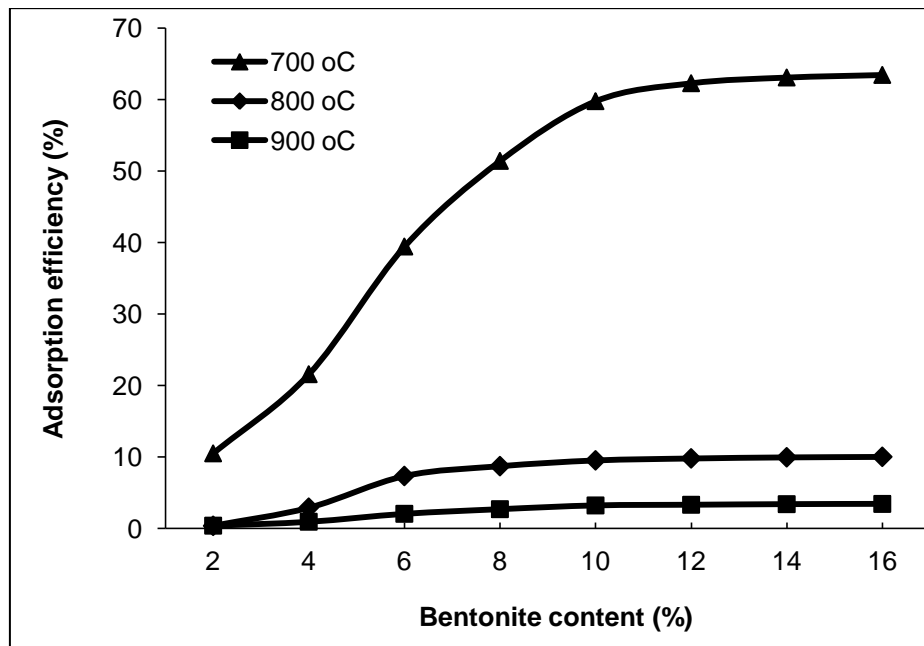
### 3.3 Adsorption efficiency

Although the general trend can be found that the S retention efficiency in the bottom ash was promoted by an increase in molar ratio of Ca/S, as shown in Fig. 4 and 5, however effect of temperature more dominant. Fig. 5 described the adsorption efficiencies for temperatures of 800 and 900 °C only up to more and less 10%. The highest efficiency was appearing at temperature of 700 °C and the bentonite content of 16%, i.e. 63.5%. In despite, the Hg adsorption efficiency was equally affected by both parameters (i.e. Ca/S ratio and combustion temperature) as exhibited by the curves in Fig. 4. The maximum efficiency was read at the same conditions to those observed for the S, with the efficiency as much as 57.2%.

It was discussed that silicon compounds are beneficial to SO<sub>2</sub> reduction from the flue gas. On the other hand, it should be noted that SiO<sub>2</sub> cannot only form silicates that enwrap the sulfation product CaSO<sub>4</sub>, but also form a CaO–SiO<sub>2</sub> phase that has a low capacity for sulfur retention. Whether the Fe–Si–Ca sorbents are beneficial or harmful during coal combustion depend upon factors such as heating rate, furnace temperature and reaction activity of the silicates [Cheng et al., 2003]. It is reported that simultaneously adding Fe<sub>2</sub>O<sub>3</sub> and SiO<sub>2</sub> into CaCO<sub>3</sub> with the same weight ratio of 0.1% promotes the sulfur removal efficiency from 41.2 to 53.8% at a constant heating rate from room temperature to 1080 °C [Chang et al., 1998].



**Figure 4** Adsorption efficiency for mercury



**Figure 5** Adsorption efficiency for sulfur

## 4 Conclusions

Based on the results and discussion, some conclusions listed here.

1. Raw or natural bentonite can be used as an adsorbent for simultaneously capture the sulfur and mercury on the coal combustion.
2. That bentonite has showed a good performance as an adsorbent for that propose.

The influence of bentonite for the sulfur adsorption was not significant, however for mercury provided more important role.

## 5 Nomenclature

$\eta$	=	adsorption efficiency (%)
$C_i (a = 0)$	=	mercury or sulfur concentration in the bottom ash without adsorbent (ppm)
$C_i (a = n)$	=	mercury or sulfur concentration in the bottom ash with adsorbent (ppm)
$C_i$ (in coal)	=	mercury or sulfur concentration in the raw coal (ppm)

## 6 References

- [1] Akpomie, K.G. & Dawodu, F.A. (2015). Potential of a low-cost bentonite for heavy metal abstraction from binary component system. Beni-Suef University Journal of Basic and Applied Sciences, xxx, 1-13 (in press).
- [2] Allo, W.A. & Murray, H.H. (2004). Mineralogy, chemistry and potential applications of a white bentonite in San Juan province, Argentina. Applied Clay Science, 25, 237–243.
- [3] Arbaoui, F. & Boucherit, M.N. (2014). Comparison of two Algerian bentonites: Physico-chemical and retention capacity study. Applied Clay Science, 91-92, 6-11.
- [4] Barbanti, D., D'Orazio, M. & Versari, A. (1997). Study on some sorption properties of bentonites for their potential use in food technology. J. Food Eng., 33, 193–206.
- [5] Bergaya, F. & Lagaly, G. (2013). General introduction: clays, clay minerals, and clay science. In: Bergaya, F. & Lagaly, G. (Eds.), Handbook of Clay Science, Amsterdam: Elsevier.
- [6] Borrelli, R.A., Thivent, O. & Ahn, J. (2013). Parametric studies on confinement of radionuclides in the excavated damaged zone due to bentonite type and temperature change. Phys. Chem. Earth, 65, 32–41.

- [7] Chang, L.P., Zhu, S.Y., Ye, J.L. & Xie, K.C. (1998). The effects of silica and ferric oxide on limestone capturing sulfur during coal combustion. *Environ. Chem.*, 17(6), 532–536.
- [8] Cheng, J., Zhou, J., Liu, J., Zhou, Z., Huang, Z., Cao, X., Zhao, X. & Cen, K. (2003). Sulfur removal at high temperature during coal combustion in furnaces: a review. *Progress in Energy and Combustion Science*, 29(5), 381-405.
- [9] Fu, Y. & Chung, D.D.L. (2011). Coagulation of oil in water using sawdust, bentonite and calcium hydroxide to form floating sheets. *Applied Clay Science*, 53, 634–641.
- [10] Guerra, D.J.L., Mello, I., Resende, R. & Silva, R. (2013). Application as absorbents of natural and functionalized Brazilian bentonite in Pb<sup>2+</sup> adsorption: Equilibrium, kinetic, pH, and thermodynamic effects. *Water Resources and Industry*, 4, 32–50.
- [11] Hanuláková, D., Zeman, J., Vašíček, R., Příklad, R. & Kuchovský, T. (2013). Determination of pore water composition during long term interaction of bentonite substrates with water media: comparative study. *Applied Clay Science*, 80–81, 69–75.
- [12] Huang, Y., Jin, B., Zhong, Z., Xiao, R., Tang, Z. & Ren, H. (2004). Trace elements (Mn, Cr, Pb, Se, Zn, Cd and Hg) in emissions from a pulverized coal boiler. *Fuel Processing Technology*, 86(1), 23-32.
- [13] Li, M., Wang, L., Chen, J.-y., Jiang, Y.-i. & Wang, W.-j. (2014). Adsorption performance and mechanism of bentonite modified by ammonium bromide for gas-phase elemental mercury removal. *Journal of Fuel Chemistry and Technology*, 42(10), 1266-1272.
- [14] Ma, Y., Qu, Z., Xu, H., Wang, W. & Yan, N. (2014). Investigation on mercury removal method from flue gas in the presence of sulfur dioxide. *Journal of Hazardous Materials*, 279, 289-295.
- [15] Manninen, H., Perkiö, A., Palonen, J., Peltola, K. & Ruuskanen, J. (1996). Trace Metal Emissions from Co-combustion of Refuse Derived and Packaging Derived Fuels in a Circulating Fluidized Bed Boiler. *Chemosphere*, 32(12), 2457-2469.
- [16] Murray, H.H. (2006). Bentonite applications. In: Murray, H.H. (Ed.), *Developments in Clay Science*, Amsterdam: Elsevier.
- [17] Nones, J., Riella, H.G., Trentin, A.G. & Nones, J. (2015). Effects of bentonite on different cell types: A brief review. *Applied Clay Science*, 105-106, 225–230.
- [18] Viseras, C., Cerezo, P., Sanchez, R., Salcedo, I. & Aguzzi, C. (2010). Current challenges in clay minerals for drug delivery. *Applied Clay Science*, 48, 291–295.
- [19] Wang, J., Zhang, Y., Han, L., Chang, L. & Bao, W. (2013). Simultaneous removal of hydrogen sulfide and mercury from simulated syngas by iron-based sorbents. *Fuel*, 103, 73-79.
- [20] Wilcox, J., Rupp, E., Ying, S.C., Lim, D., Negreira, A.S., Kirchofer, A., Feng, F., & Lee, K. (2012). Mercury adsorption and oxidation in coal combustion and gasification processes. *International Journal of Coal Geology*, 90-91, 4–20.
- [21] Williams, L.B., Hayde, S.E. & Ferrell Jr., R.E. (2009). Bentonite, bandaids, and borborygmi. *Elements*, 5, 99–104.
- [22] Xu, W.-C. & Kumagai, M. (2003). Sulfur transformation during rapid hydrolysis of coal under high pressure by using a continuous free fall pyrolyzer. *Fuel*, 82, 245–254.
- [23] Yan, R., Gauthier, D., Flamant, G. & Badie, J.M. (1999). Thermodynamic study of the behavior of minor coal elements and their affinities to sulfur during coal combustion. *Fuel*, 78, 1817–1829.
- [24] Yao, H. & Naruse, I. (2005). Control of trace metal emissions by sorbents during sewage sludge combustion. *Proceedings of the Combustion Institute*, 30(2), 3009-3016.
- [25] Zhou, J., Cheng, J., Cao, X., Liu, J., Zhao, X., Huang, Z., & Cen, K. (2001). Experimental research on two-stage desulfurization technology in traveling grate boilers. *Energy*, 26(8), 759-774.

# Use of Social Media for supporting Administrative Rulemaking for a Private University in Bangladesh

<sup>1</sup>Md. Emran Hossain & <sup>2</sup>Yousuf Mahbulul Islam

<sup>1</sup>Daffodil International University, emran@daffodilvarsity.edu.bd, +8801711538474

<sup>2</sup>Daffodil International University, ymislam@daffodilvarsity.edu.bd, +8801711876909

## Abstract.

The use of Social Media to gather information from the public or feedback on products, services and even government agencies is gaining both popularity and momentum. These social media tools broadly include any online tool that facilitates two-way communication, collaboration, interaction, or sharing the between institutions and the public. Examples of social media tools currently in use include Facebook, Twitter, Ideascade, blogs and various other crowdsourcing platforms. Over the last 25 years, in Bangladesh, private universities have sprung up like mushrooms. Many of these institutions have started without complete rules and policies in place. As such, ad hoc administrative problem solving has become a regular feature of each working day keeping administrators busy all the time. The idea being toyed by the authors is whether social media and/or crowdsourcing tools can be used to support university administration. To see whether this idea has any merit, Daffodil International University (DIU) launched an e-forum in 2009 where students, teachers and administrators participate on various open issues. This paper analyses the areas discussed in the open forum statistically analyzing 5 years of data from 2009 to 2014 and the open contribution to administrative issues.

**Keywords:** *administrative issues; crowd sourcing; rulemaking; social media; policy making.*

## 1 Introduction

The use of Social Media to gather information from the public or feedback on products, services and even government agencies is gaining both popularity and momentum. These social media tools broadly include any online tool that facilitates two-way communication, collaboration, interaction, or sharing the between institutions and the public. Examples of social media tools currently relies, or effectively exercise their right to comment on the rule before it is adopted.” (Kerwin in use include Facebook, Twitter, Ideascade, blogs and various other crowdsourcing platforms. The idea behind government agencies using social media platforms is explained by Farina & Newhart (2013). It is to allow the public at large to

“—take advantage of their right to review the information on which the rulemaking agency, 2003, p. 182–84; Yackee and Yackee, 2006 as cited in Farina & Newhart, 2013)

Citizens have a right to review the data on which a proposed rule is being formulated and they have a right to comment on the rule before it is adopted as law by the government. This is because the rule, when it becomes law would ultimately affect their day to day life and businesses. However, as pointed out by Farina & Newhart (2013) public awareness of the rule making process is low with only major corporations and businesses participating in the rulemaking process. Public information on the rulemaking process is given in websites similar to that at Federal Communications Commission (n.d.). It is to improve the participation in the rulemaking process that prompted the e-Government Act of 2002. The e-Government Act of 2002 required agencies to accept comments “by electronic means” and to make available online the public comments and other materials included in the official rulemaking docket. (Farina & Newhart, 2013)

However, collecting purposeful feedback using Social Media tools is not without its pitfalls. Green (2012) discusses an ongoing project to discover the ongoing pros and cons of gathering comments for



rulemaking. As there are more questions than answers about what value social media and other Web 2.0 technologies can bring to rulemaking Farina and Newhart (2013) set out to find some answers.

Farina & Newhart (2013) have come up with guidelines on how to effectively harness the power of gathering opinion using Social Media. They look at barriers, types of participation and how to increase the quality of participation, *i.e.*, how to make participation useful to the rulemaking process.

## 2 Private University Rulemaking in Bangladesh

Over the last 25 years, in Bangladesh, private universities have sprung up like mushrooms. Many of these institutions have started without the benefit of complete rules and policies in place. As such, ad hoc administrative problem solving has become a regular feature of each working day keeping administrators busy all the time. The challenge is how to put rules and policies in place that would help the day to day running of the administrative procedures at the university and facilitate appropriate learning of the students enrolled.

Currently, there is very little research or participation on rulemaking at these private universities in Bangladesh. Therefore, often rules are made without recourse to realities on the ground and thus not followed. An example rule pointed out by Islam (2013) is the medium of Instruction (MOI). The policy is that the medium of instruction in the classrooms must be English. However, in reality, teachers in the classrooms hardly speak in English other than academic terms. Students often do not like teachers using pure English – some find it difficult to follow. When foreign students join a class and teachers are forced to speak in English local students do not like it. If students and teachers participate in the rulemaking on MOI, it may prove to be more effective in that finding ways how the policy can be implemented.

Looking for feedback through the use of Social Media for policies such as that on the MOI may not only help in better formulating the policy, it may also help in implementing the policy. The question is therefore can the collaborative value of social media be harnessed for rulemaking at private universities in Bangladesh?

## 3 Using Social Media for Rulemaking

The idea being toyed by the authors is whether social media and/or crowd sourcing tools can be used to support university administration. To see whether the use of Social Media has any merit, Daffodil International University (DIU) launched an e-forum in 2009 where students, teachers and administrators participate on various open issues. This paper analyses the areas discussed in the open forum analyzing 5 years of posts/comments from 2009 to 2014 and the open contribution to administrative issues to see whether open discussions demonstrate an interest in policy matters and problems.

## 4 Methodology

To gauge public interest in policy and administrative matters, it was decided to use the open discussion forum at <http://forum.daffodilvarsity.edu.bd>. The idea was to find out whether the open forum is used to openly discuss policy matters by the university members that consists of students, teachers and administrative staff. To do this, the administrative *search* option was used to look up three keywords, *i.e.*, policy, strategy and rules. However, this search did not yield useful results. The policies discussed dealt with policies of the government, *i.e.*, nothing to do with the university. We then changed our search string to education, teacher, student and university. Having found posts that mention these keywords, the posts were analyzed into the following categories:

1. Need (for a rule or policy)
2. Suggestion (for improvement or modification of a policy )
3. Problem (faced with existing policy)

## 5 Results and Analysis

To start work on the forum, the statistics as shown in Table 1 were derived.

*Table 1: Statistics of the open forum at Daffodil University*

<b>Information source</b>	Daffodil International University (DIU) Forum
<b>Keywords Used</b>	Education, Teacher, Student, and University
<b>Classifications</b>	Need, Suggestions/modification, Problem
<b>Total posts in forum</b>	75,307
<b>Total Topics</b>	26,597
<b>Total Members</b>	4,322

For the search words, the following numbers of posts were found. Out of the total posts found a sample was selected for analysis.

Key words	Total posts in DIU Forum	Sample collection	Classification		
			Need	Suggestion	Problem
Education	30	20	6	10	4
Teacher	30	18	6	8	4
University	30	11	8	3	N/A
Student	30	13	4	6	1

From the samples collected three examples are furnished below:

<p><b>Connection to Community</b>                      For low-income students or students who are new to the school, Educational trips that take advantage of local resources promote community connectivity. For example, a student may not ever have the opportunity to visit a local park or bank, which are important resources within a community for both the student and his family. Students from non-English-speaking families or who have recently moved to the community get the chance to learn about the local area with the guidance of their school, as well as share the information with their family when they return home.</p>
--

*Figure 1. Example of Need: Educational trips – one out of 10 reasons posted by a student in the forum*

The thoughts of the student shows thoughts regarding poor students, implying those who do not have access or ability, e.g., students from rural areas would benefit highly from educational trips. Given such thoughts, the university could decide to set up a policy for educational trips and/or create a budget in each department for such trips. Normally, university administration would not think of creating or implementing such a policy.

### Changing school policies

Among some of the changes she would like to see made: the addition of neuroscience to teacher training courses, and a later start to the school day. Blakemore said that education is nothing if not the process of molding the brains of children, and that teens tend to release the sleep hormone melatonin later in the day than adults, meaning they need more sleep in the morning.

She also argues that adolescent brains have tremendous creative capabilities, and that secondary schools aren't doing enough to tap into that potential. In 2011, she advised government officials to expand their focus from younger students to include middle schoolers, claiming that policy makers should consider the large amounts of new data of brain development at this age.

Figure 2. Quoting from an article, a student suggests implementing of “brain-friendly” policies

The sample in Figure 2 shows that students read up about themselves and can contribute in thinking about policies that deal with them – in this case, how the teenage brain works – a suggestion for a policy.

### Conclusion

Academic integrity, including plagiarism avoidance, should be taught to young students as soon as they begin to write papers. A respect for intellectual property and one's reputation should be instilled in learners as early as possible. As Honig and Bedi (2012) suggested, a system of monitoring and censure should also be implemented world-wide for all scholarly research. The many instances of plagiarism throughout the world are disconcerting. In a technologically advanced world with a global marketplace, scholarly researchers should be held to the highest standards. This is especially so with the advent of the technological tools and information offered by companies such as Elsevier.

Figure 3. Quoting from an article, a teacher discusses plagiarism problems and provides suggestions

The sample in Figure 3 shows a teacher discussing plagiarism in academic publishing and suggests how students should be guided to good publishing practices right from the word go. This is something that the university can think about and make a policy.

## 6 Conclusions

Although the number of posts found using the search strings of education, students, teachers and university are relatively few, the nature of postings provide feedback from stakeholders that may lead to administrators to think about creating policies. The very useful report by Farina & Newhart (2013) talks about barriers to effective participation that include lack of awareness, participation literacy (*i.e.*, how to use a forum) and information overload – all of which can affect lack of effective feedback. In our case all samples were unsolicited participation and show a stakeholder interest. Also, as pointed out by Farina & Newhart (2013), effective feedback on policy suggestions would require identification, reach and access of the appropriate stakeholders.

## 8 Reference

- Farina, C.R., & Newhart, M.J. (2013). Rulemaking 2.0: Understanding and Getting Better Public Participation. Cornell e-Rulemaking Initiative Publications. Paper 15. Cornell Law Library. Retrieved March 29, 2015 from <http://scholarship.law.cornell.edu/cgi/viewcontent.cgi?article=1014&context=ceri>
- Federal Communications Commission. (n.d.). Rulemaking Process at the FCC. Website. Retrieved March 29, 2015 from <https://www.fcc.gov/encyclopedia/rulemaking-process-fcc>
- Green, A. (2012). Social Media and Public Comments in Rulemaking. Website. Sunlight Foundation. Retrieved March 29, 2015 from <https://sunlightfoundation.com/blog/2012/11/15/social-media-and-public-comments-in-rulemaking/>
- Islam, M. M. (2013). English Medium Instruction in the Private Universities in Bangladesh. *Indonesian Journal of Applied Linguistics*. Vol 3, No. 1, pp.126-137. Retrieved March 29, 2015 from [https://www.academia.edu/3885714/ENGLISH\\_MEDIUM\\_INSTRUCTION\\_IN\\_THE\\_PRIVATE\\_UNIVERSITIES\\_IN\\_BANGLADESH](https://www.academia.edu/3885714/ENGLISH_MEDIUM_INSTRUCTION_IN_THE_PRIVATE_UNIVERSITIES_IN_BANGLADESH)
- Kerwin, C. M. (2003). Rulemaking: How government agencies write laws and make policy (3rd ed.). Washington, D.C.: CQ Press. As cited in Farina & Newhart (2013).
- Yackee, J. W., & Yackee, S. W. (2006). A bias towards business? Assessing interest group influence on the U.S. bureaucracy. *The Journal of Politics*, 68(1), 128–139. As cited in Farina & Newhart (2013)

## Acknowledgement

This is to acknowledge support of Administrative Officer Md. Abdullah-Al-Mamun (Badshah) and Asst. Admin Officer Md. Neamat Ullah in collecting the data from the university forum.

# **The Development of Fastest Path Simulation for Emergency Vehicles Using VANET Technology**

**<sup>1</sup> Afdhal, <sup>2</sup>Elizar & <sup>3</sup>Sayed Muchallil**

<sup>1,2,3</sup>Electrical Engineering Department, Engineering Faculty, Universitas Syiah Kuala  
Jalan Syech Abdurrauf No.7 Darussalam - Banda Aceh 23111

<sup>1</sup>afdhal@unsyiah.ac.id, <sup>2</sup>elizar.mustafa@unsyiah.ac.id,  
<sup>3</sup>sayed.muchallil@unsyiah.ac.id

## **Abstract**

One of the high-level problems in the transportation system is the disruption of the mobility of emergency vehicles. If the emergency vehicles such as ambulance must be stopped due to traffic congestion, there will be a delay in providing the service. The community as the user of this vehicle will be harmed. Therefore, this research developed a simulation using VANET technology as an ICT-based transportation management system. This simulation offers the shortest path solutions and alternative routes as the fastest path to avoid the congestion that can be reached by emergency vehicles to arrive at the destination in a timely manner. As a case study, this research simulates the movement of emergency vehicles using network topology maps and road traffic mobility in the city of Banda Aceh. Based on the evaluation and analysis of travel time and average speed by varying levels of traffic density can be seen that the VANET technology can be used to manipulate traffic mobility to be more effective and efficient. Traffic engineering methods with the route replacement techniques can reduce travel time and increase the average speed of vehicles.

**Keywords:** SUMO, TraCI, NS-2, VANET, V2I

## **1 Introduction**

Based on Population Reference Bureau (PRB) 2013 population data sheet [1] world has around 7.136 billion inhabitants. This impact on the number of vehicles even in the urban area. The increment of the vehicles affects the traffic which can be lead to some accidents. According to WHO, traffic accident had killed around 3,400 lives and injured about other 10 million daily [2]. Those facts should be considered by the government, society and especially by education institution to find out the best solution. In order to manage the transportation system, United State Department of Transportation (U.S. DOT) Research and Innovative Technology Administration (RITA) developed several applications based on wireless communication technology. These applications are to support the development of Intelligent Transportation System (ITS). The purpose of this technology is to manage traffics using information system based on the radio technology to communicate between vehicles that known as Dedicated Short Range Communications (DSRC) [3].

Along with the development of ITS technology, IEEE Working Group adopted DSRC and develop a new suite standard and regulation for wireless communication in the vehicular environment. This suite standard known as Wireless Access in Vehicular Environments (WAVE). This standards includes: IEEE 802.11p [4], IEEE 1609.1 [5], IEEE 1609.2 [6], IEEE 1609.3 [7], and IEEE 1609[8]. WAVE is an IEEE suite standard that focuses on data exchange between vehicles and vehicles to infrastructures. This new suite standard is intended as the Protocols for Vehicular Ad-hoc Network (VANET). VANET is a new technology that expected can be used as a solution to manage the transportation system in ITS environment. The primary target of VANET technology is safety application that can prevent collision and save thousands of lives. Along with the development, this application is also targeting on adaptive traffic control, peer to peer network internet surfing, games online and many others [9].

In the urban area, traffic congestion has become a problem that has to be solved. One of the high-level problems in the transportation system is the disruption of the mobility of emergency vehicles. If the emergency vehicles such as ambulance must be stopped due to traffic congestion, there will be a delay in providing the service. The community as user of this vehicle will be harmed. On other hand, the appropriate use of VANETs communication technologies is believed can influence positively to enhance the quality of urban travel. Therefore, this research objective is to develop a simulation which implemented VANET technology for emergency vehicles so that they can find the fastest route to reach their destination by avoid several traffic congestion. The rest of this article is organized as follows: the literature review of VANET will be discussed in section 2. Section 3 will be about the Simulation Development and Result will be in section 4 and 5 respectively. Conclusion will be in section 6

## 2 Vehicular Ad-hoc Networks

The used of VANET is to enable the communication of Vehicle to Vehicles (V2V) and Vehicles to Infrastructures (V2I). The aim of this system is to improve the management of the transportation system so that ITS applications can be implemented. This technology also expected to reduce traffic congestion so that the traffic accident can be minimalized [9]. As mentioned previously, the VANET is based on a set of standards that IEEE suggested also known as WAVE. The architecture of WAVE is supported by some protocols which are dependent each other. These protocols have been mention in section 1 as shown in Figure 1.

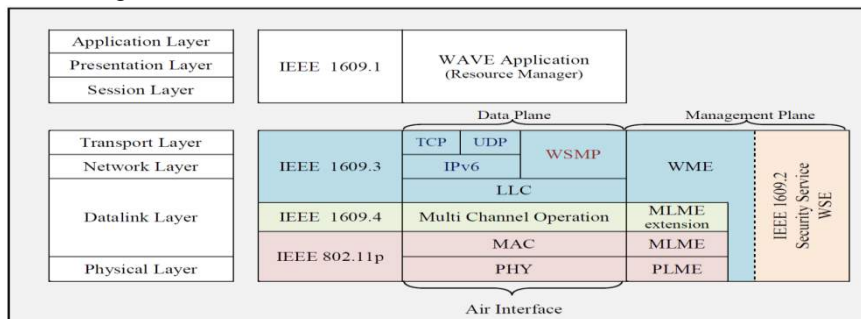


Figure 1. WAVE Architecture

IEEE 802.11p is a physical layer also some datalink layer. IEEE 1609.1 is a protocol that communication of Onboard Unit (OBU) and Road Side Unit (RSU) take place. This protocol can also be considered as application layer. IEEE 1609.2 is a protocol for security purpose. IEEE 1609.3 and IEEE 1609.4 is a protocol for channel selection and data packet exchange standard respectively [10]. WAVE consists of two units, Onboard Unit (OBU) and Road Side Unit (RSU). RSU is an infrastructure that used as gateway for data exchange between vehicles. While OBU is a unit which installed inside a vehicle. The unit can send or change data to other OBU [11]. Data exchange between OBU are also known as Vehicles to Vehicles (V2V). On the other hand, the Vehicles to Infrastructure (V2I) is the communication between OBU and RSU. Both of these communication types can be seen in Figure 2

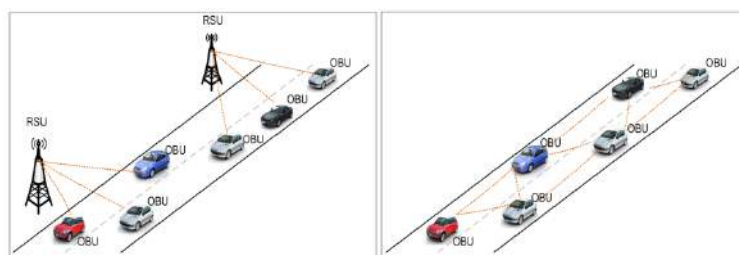


Figure 2. V2I and V2V communication

Morgan suggested [11] that the transmission distance should be less than 1 km with 6 – 27 Mbps transfer rate. Table 1 shows the differences between WAVE and other wireless technology.

Table 1. WAVE and other wireless technologies [11]

	<b>WAVE</b>	<b>FM Radio</b>	<b>Cellular</b>	<b>WiMAX</b>	<b>Satellite</b>
Max. Range (km)	<1	hundreds	<10	<10	thousand
Data Rate	6-27 Mbps	< 10 Kbps	<100 kbps 3G 2-3Mbps	70 Mbps	100-200Mbps
Coverage	LoS-2way	Area-1way	Area-2way	Area-2way	Area-2way
Cost (per-bit)	free	free	\$\$	\$	\$\$

### 3 Mobility Models

VANET network has a very high movement of the node, very dynamic topology, high level of freedom and some limitation in node mobility as well. In addition, mobility of the node usually limited by highways, roads and small streets, so that the vehicle speed and the accuracy of the road map have to be perfectly predicted. Thus, the general pattern of mobility modeling approach is very difficult to implement to serve as a reference for VANET traffic mobility. Therefore we need a certain mobility models by utilizing the traffic flow information and an accurate roadmap information [12]. Traffic mobility model plays an important role in designing a VANET network. According to Harri et al., Modeling traffic vehicle network mobility can be done by using 4 (four) approach [13]:

#### 1. Synthetic Model

Synthetic model is based on mathematical modeling, in which the model is developed to understand the specific movement of the vehicle which is then translated into a mathematical formulation. This mobility modeling can be divided into several approaches, including: stochastic models, traffic flow models, car-following models (CFM), queuing models and behavior models. The limitations of this approach is the model have a high level of complexity

#### 2. Survey-based Model

Survey-based model approach is based on the results of the survey of traffic mobility patterns. This model is used for calibrating the traffic mobility model by using the results of surveys or statistical approaches. The limitations of this model is that the result of surveys or statistical data is only able to provide a very rough mobility models, so as to obtain the realistic representation of traffic mobility it required a more complex mathematical models.

#### 3. Trace-based Model

This model is based on the pattern of movement of traffic mobility. This model has been able to separate a traffic mobility model that reflects a more realistic pattern of pedestrian movement.

#### 4. Simulation-based Model

This model is based on simulation tools to generate traffic mobility pattern. Basically, this approach is the result of a common combination from synthetic model, survey model and pattern tracing model approach. This model represents the separation of vehicle mobility tracing based on detailed traffic simulator. The combination between traffic generating simulator and network simulator can provide access to validated traffic pattern and able to obtain the level of detail that cannot be obtained from the other traffic mobility model. The model that based on traffic generating simulator has shown increasing popularity among the research community because this model allows to obtain a level of precision that cannot be achieved by purely synthetic model

In the modeling of traffic mobility simulation, the choice of interaction and integration between plant simulator traffic (traffic generator) and a network simulator (network simulator) has a very important role in the success of a more realistic simulation model. Interaction and integration between traffic generating simulator and network simulator can be divided into three classes modeling, covering [13]:

#### 1. Isolated Mobility Models

Isolated mobility model is a mobility movement patterns generated by traffic generating simulator and directly allows mobility scenarios to be integrated into a network simulator. The architecture of isolated mobility model is shown in Figure 3. The interaction process between traffic generating simulator and network simulator is unidirectional. This model does not allow changes to the mobility scenario. Traffic generating simulator will have no feedback from network simulator.

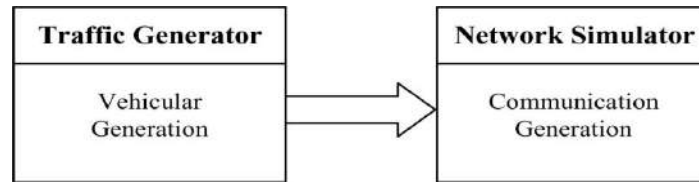


Figure 3. Isolated mobility modelling [13]

## 2. Embedded Mobility Models

This modeling is one of the solutions to overcome the disadvantages of isolated mobility model in its way to integrate both traffic generating simulator network simulator. The solution is to put that two types of simulators integrated each other and can be interacted between both simulator with a simple simplistic off-shelf-discrete event simulator. The architecture of this model is illustrated in Figure 4. The limitations of this modeling is the less quality of traffic mobility tracing pattern results, it is because of the feedback obtained from both simulator cannot be realistically generated.

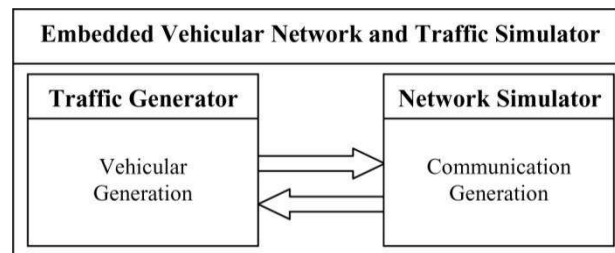


Figure 4. Integrated mobility modelling [13]

## 3. Federated Mobility Models

This modeling is an approach that recently developed for modeling a more realistic traffic mobility. Federated mobility modeling is the result of a combination of traffic generating simulator and network simulator that has been previously developed. The process of integration and interaction between both simulators are combined through a set of interfaces called communication interface. The architecture of this modeling is illustrated in Figure 5.

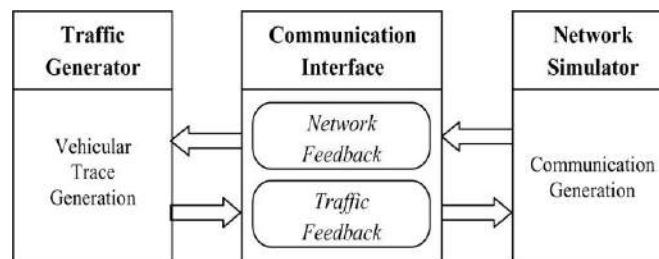


Figure 5. Federated mobility modelling [13]

Federated mobility model independently integrate both traffic generating simulator and network simulator. This model allows user to achieve a number of advantages and can be the best solution to combine the two types of simulators effectively and efficiently. The advantages of this model is that it can run simultaneously both types of simulators, so that it can facilitate the modeling of VANET simulation in more realistic and close to the actual state [13].

## 4 The Simulation Development

In order to develop a more realistic simulation modeling, this study used two types of simulation tools which are SUMO as traffic generating simulator (traffic generator) combined with NS-2 as a network simulator. This study also utilizes network TraCI to obtain network and traffic feedback from both



simulator. According to the classification of types of mobility modeling, the modeling of this kind is called federated mobility modeling. It aims to obtain a simulation modeling very close to real situation.

Figure 6 shown, The step-by-step development of simulation begins by determining interconnected nodes so that all joined interconnected nodes can be developed into a topology map of the road. The next step is determining vehicle traffic in the form of traffic flow and traffic trip which were traversed by vehicles. The process of determining both parameter are based on the topology map that has been built previously. After vehicle traffic completed, the it will be integrated with topology map before it configured into a map of the network traffic and routing that will be passed by all vehicle nodes involved in the simulation.

Once integrated and configured, the topology map can used for traffic modelling. Based on the developed traffic model, VANET network applications called V2I will be built both in terms of the RSU and OBU. V2I is the application that can be used by a vehicle to interact and communicate using existing OBU with the RSU placed along the road which passed by the vehicle. Both simulators work simultaneously, so that each simulator will provide feedback, in this case network simulator provides feedback to traffic simulator and vice versa. The output of both simulator will produce travel time estimation and vehicle speed that can be used to calculate the shortest path or the fastest path passed by a vehicle based on distance and traffic density in accordance with generated simulation parameter.

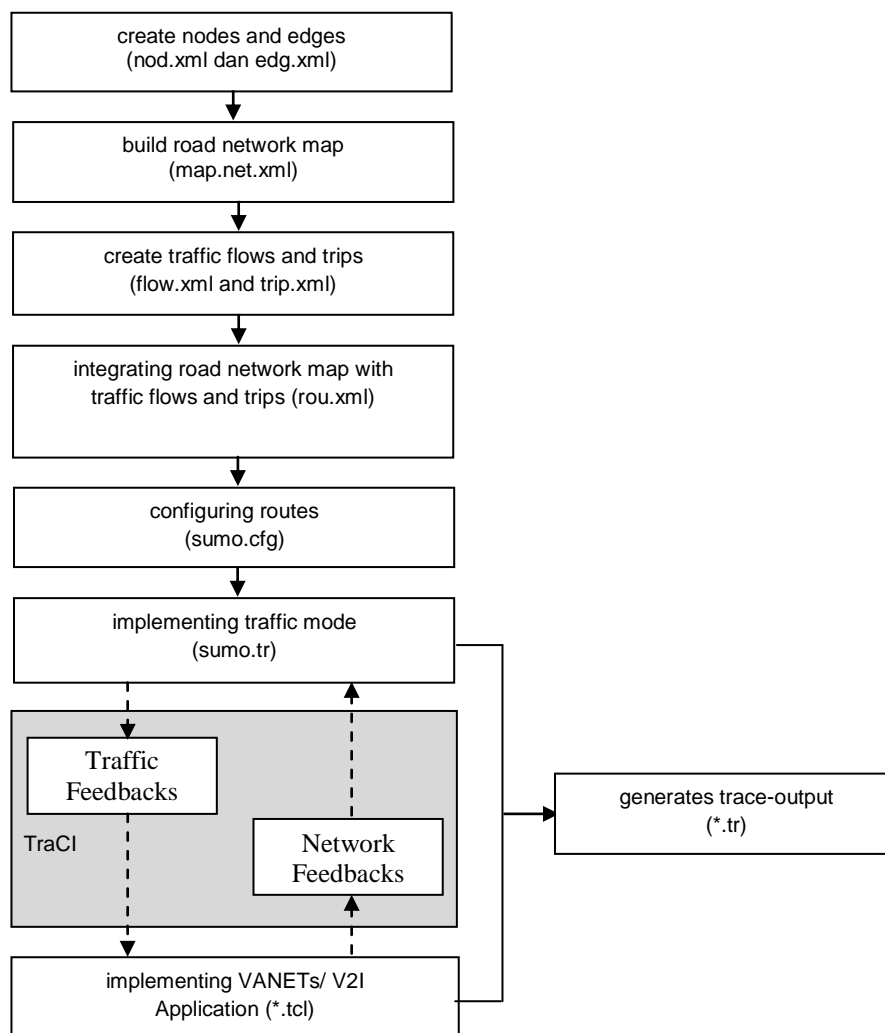


Figure 6. Simulation Development Framework

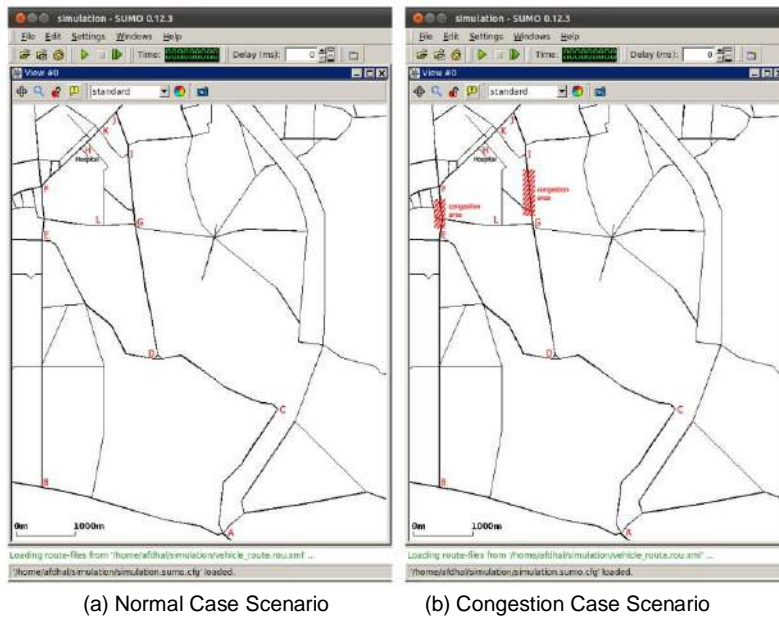


Figure 7. Testing study case

A case study is taken to perform application testing, where an emergency vehicle from point A traveled to point H. The route have 5 alternative route that can be selected. The scenario of case study developed for this simulation can be seen as illustrated in Figure 7.

## 5 Result and Analysis

Based on simulation testing shown that the traffic density plays an important role in traffic mobility, both in terms of travel time and route path.

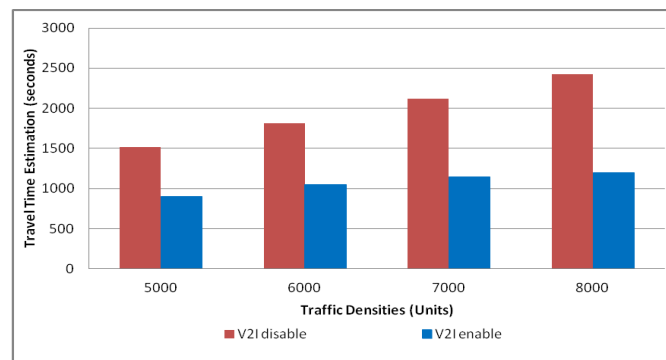


Figure 8. V2I travel time estimation-disable/enable vs traffic density

Figure 8 above shows that the higher traffic density will increase travel time significantly. The use of VANET technology can engineered vehicle traffic to reduce travel time at the time of traffic density level increased. The percentage of this technology capabilities to control travel time in the mean of traffic density is shown in Table 2.

Table 2. Travel time efficiency

Traffic Density	Travel Time Estimation		Travel Time Efficiency Percentage
	V2I-disable	V2I-enable	
5000 units	1513 s	0898 s	59,4%
6000 units	1815 s	1050 s	57,9%
7000 units	2118 s	1145 s	54,1%
8000 units	2420 s	1200 s	49,6%

Another parameter related to traffic mobility is the vehicles average speed. The vehicle average speed velocity is the ratio of total displacement with respect to travel time. Figure 9 shows that the use of VANET technology can engineered the use of alternative route path. In this case the trajectory path that has a chance to avoid the congestion is used as an alternative route to prevent a significantly decrease in the VANET vehicle average speed compared to the average speed of vehicles without VANET technology.

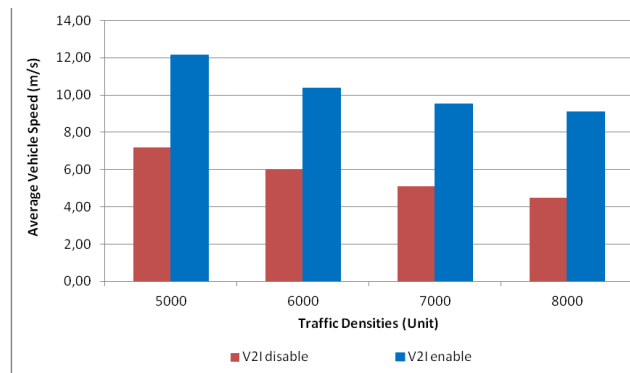


Figure 9. V2I vehicle average speed-disable/enable vs traffic density

The capabilities percentage of VANET technology to increase vehicle average speed in the mean of traffic density is shown in Table 3.

Table 3. Vehicle average speed percentage

Traffic Density	Vehicle Average Speed		Travel Time Enhancement Percentage
	V2I-disable	V2I-enable	
5000 unit	7,17	12,14	59,1%
6000 unit	5,97	10,38	57,6%
7000 unit	5,12	9,52	53,8%
8000 unit	4,48	9,08	49,3%

Based on the result from travel time and vehicles average speed evaluation and analysis by varying level of traffic density, it can conclude that the VANET technology can be used to control traffic mobility effectively and efficiently. Traffic engineering methods with these change route techniques can reduce travel time and increase vehicles average speed.

## 6 Summary

The conclusions that can be drawn from the results of the fastest route simulation development for emergency vehicles in this study are as follows:

1. The VANET technology with V2I Cooperative Awareness applications can be used to control traffic mobility, spesifically to obtain the fastest route for emergency vehicles to avoid congestion in certain area.
2. V2I Cooperative Awareness applications with its traffic engineering methods can reducing travel time and increasing vehicles average speed as well as optimising the use of routes that rarely being used as an alternative route to obtain fastest route eventough the route is not the shortest route.

## Acknowledgement

This research is funded by Syiah Kuala University under Young Research Staff Initiative Grant No. 427/UN11/S/LK-PNBP/2014 Date 5th May 2014.

## References

- [1] World Population Datasheet 2013 [Online] Available at: <http://www.prb.org/Publications/Datasheets/2013/2013-world-population-data-sheet.aspx>
- [2] World Traffic Injuries [Online] Available at: [http://www.who.int/violence\\_injury\\_prevention/road\\_traffic/en/](http://www.who.int/violence_injury_prevention/road_traffic/en/)
- [3] Intelligent Transportation System [Online] Available at: <http://www.its.dot.gov/>
- [4] IEEE 802.11p (2010) IEEE Standard for Information Technology of Telecommunication and information exchange between systems for local and metropolitan area network, Specific requirements Part 11: Wireless LAN Medium Access Control (MAC) and Physical Layer (PHY) Specification, Amendment 6: Wireless Access in Vehicular Environment. IEEE Computer Society. New York, USA: The Institute of Electrical and Electronics Engineers, Inc.
- [5] IEEE 1609.1 (2006) IEEE Trial-Use Standard for Wireless Access in Vehicular Environments (WAVE) – Resource Manager. IEEE Vehicular Technology Society. New York, USA: The Institute of Electrical and Electronics Engineers, Inc.
- [6] IEEE 1609.2 (2006) IEEE Trial-Use Standard for Wireless Access in Vehicular Environments (WAVE) – Security Service for Application and Management Message. IEEE Vehicular Technology Society. New York, USA: The Institute of Electrical and Electronics Engineers, Inc.
- [7] IEEE 1609.3 (2010) Revision of IEEE Std. 1609.3-2007: IEEE Standard for Wireless Access in Vehicular Environments (WAVE) - Networking Services. IEEE Vehicular Technology Society. New York, USA: The Institute of Electrical and Electronics Engineers, Inc.
- [8] IEEE 1609.4 (2010) IEEE Standard for Wireless Access in Vehicular Environments (WAVE) – Multi-Channel Operation IEEE Vehicular Technology Society. New York, USA: The Institute of Electrical and Electronics Engineers, Inc
- [9] Jiang, D. & Delgrossi, L. (2008) IEEE 802.11p: Towards an International Standard for Wireless Access in Vehicular Environments. In IEEE Conference on Vehicular Technology. p.2036-2040.
- [10] Hiertz G. R, Denteneer, D., Stibor, L., Zang Y., Costa X. P. & Walke B. (2010) The IEEE 802 Universe. IEEE Communication Magazine. Vol.48(1). p.62-70.
- [11] Morgan Y. L. (2010) Notes on DSRC & WAVE Standard Suite: Its Architecture, Design, and Characteristics. IEEE Communication Surveys & Tutorial. Vol.12(4). p.504-518.
- [12] Khairnar, V. D. & Pradhan S. N. (2011) Mobility Models for Vehicular Ad-hoc Network Simulation. In IEEE Symposium on Computers & Informatics (ISCI 2011). p.460-465
- [13] Härrä, J., Filali, F. & Bonnet, C. (2009) Mobility Models for Vehicular Ad Hoc Network: A Survey and Taxonomy. IEEE Communication Surveys & Tutorial. Vol.11(4), p.19-40.

## Minimizing The Cost for Repairing Road with Pavement Recycling, Hafnidar A. Rani

Civil Engineering, Universitas Muhammadiyah Aceh, [nidarrani@yahoo.com](mailto:nidarrani@yahoo.com),  
+6281260928920

### ABSTRACT

Road infrastructure has a very important role to support the economic growth, both for goods distribution and services. High traffic growth, as a result of economic growth, can cause serious problems if it is not matched with the quality of improvement of existing roads infrastructure. It is necessary to increase the quality and quantity of existing road infrastructure, as the good roads will be influenced on the smooth of traffic flow. Road improvements are usually constructed by coating over the old pavement. It causes economic problem, which is, more construction waste resulted from it. It also causes the environmental impact, especially in urban areas that is the increasing of residential, office and other buildings elevation. Solution to this problem is to dredge the first layer of the old pavement surface by cold milling. The large amount of reclaimed asphalt pavement resulted from the dredge needs to be recycled and to be re-used as the pavement material (pavement recycling). The use of new material can be reduced by recycling technology as minimum as possible. Moreover, the traffic burden on the existing road network due to the cost of material mobilization also can be decreased so that the competitive cost construction can effectively minimize the cost of road maintenance.

**Keywords:** *road repair, cost, pavement recycling, cold milling, reclaimed asphalt pavement.*

### I. INTRODUCTION

The road is the land transportation infrastructure that has function as the vehicle traffic in moving from one place to another place. The road has the important roles because it is one of the driving wheels of the economy as well as community activities medium and infrastructure in the various sectors such as economic, social, political, cultural and security. The impact of the vehicles increasing is the increasing of the road damage level. The damage of the road becomes one of the serious problems that have to be solved. In order to overcome the problem that continuing occurred, the various parties involved have to try hard in finding the solution by applying the various effective technology to find the solution of the road damage.

The cost aspect is one of the factors that affect the implementation of the road construction project. Therefore, it is needed the good planning budget to avoid the improvidence. The cost analysis in the road pavement coarse is done to detect the savings can be done. The objective of the research is to determine the cost required for pavement recycling using cold milling by re-utilizing reclaimed asphalt pavement.

## II. STUDY LITERATURE

### 2.1 Road Pavement

Sukirman (1999) mentioned that the sub grade only usually can not be strong enough to resist deformation because of reinforced wheel weight, it is needed the additional coarse lies between the ground and the wheel or the most upper coarse of the road load. This additional coarse is made of special material that has better quality and can spread wider wheel load on the ground, so that the tension occurs because of the traffic load becomes smaller than the ground limit tension of the ground permit. This material is named with pavement coarse material.

### 2.2 Type of the Road Pavement

Generally, the road pavement consist of several pavement coarse types lay from the bottom to the top as follows :

1. Sub grade;
2. Subbase course;
3. Base course;
4. Surface course.

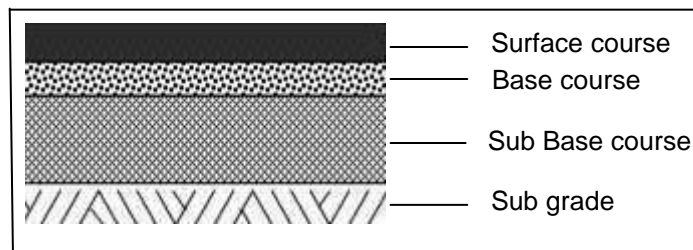


Figure 2.1. Non Rigid Road Pavement Layer (Sukirman,1999)

### 2.3. Pavement Damage Causes

According to Sukirman (1999), the damage of the road indicates that the structural and functional condition of the road can not be able to provide the maximum service to the people using the road, such as uncomfortable and unsecure of the people driving the vehicles in the surface and slippery road. The damage of the road pavement construction can be caused by several factors as follows:

1. Traffic, including the increasing of load and load repetition. The more repetitive loads cause the higher level of road damage;
2. Water, which is derived from rainy, the bad road drainage system, and rising water due to the capillarity physical characteristic;
3. Pavement construction material, which can be caused by the material characteristic or the material processing process that is not good;
4. Climate and weather, Indonesia has tropical climate which temperatures and rainfall is generally high, can be one of the causes of the road damage;
5. Unstable sub grade condition, can be caused by the bad construction sistem, or can also be caused by the bad sub grade characteristic;
6. Pavement layer compaction process upper the sub grade which is not properly done.

The damages generally occur not only because of one factor but also the combination factors that related each other.

#### **2.4. Desain Period**

Based on the Manual of Road Non Rigid Pavement Planning by using Component Analysis Method 1987, explained that the desain period is the amount of the time and year counted since the road first used until the time for the reparation or need to add the new surface.

According to Sukirman (1999), desain period is the total of the years from the road first used until structural reparation. During the desain period, the road pavement maintenance must be done, such as the non structural coarse that is important for wearing layer and water impermeability. The desain period of the new road non rigid pavement is generally 20 years and for the road improvement is 10 years. The desain period that is more than 20 years become not economic because the traffic development is too high and it is difficult to get the sufficient accuracy.

#### **2.5. Road Repaired**

The road that the service period has expired has reached the final surface index and needs to be covered by the additional coarse in order to regain its strength value, comfortable level, safety level, water permeability level, and water flow level. The road repaired planning steps with the overlay mention below:

1. Average daily traffic (LHR);
2. Relative strength coefficient (a) of each coarse;
3. The coarse thickness of the previous road;
4. Existing pavement thickness index (ITP);
5. Equivalent value of the vehicle wheel axle load (E);
6. Traffic in the design lane;
7. Resilience Modulus;
8. Reliability;
9. Surface Index (IP);
10. Pavement Thickness Index needed (ITP needed).

#### **2.6. Recycling for Road Asphalt Pavement**

The waste of the road asphalt pavement is the valuable resource that can be recycled. The waste is recycled more not only in the cities where are difficult to get the disposal locations, but also in the whole of Japan for environmental and resource conservations.

The material recycling on the previous pavement by:

1. Dredging the asphalt layer and used as the mixed basic material distabilized using foamed bitumen to construct the strong flexible base coarse (Cold Mix Recycling by Foamed Bitumen Base, CMRFB-Base).
2. Stabilization of existing base course material with Portland Cement to construct the strong semi rigid base coarse (Cement Treated Recycling Base, CTRB).

Figure 2.2, each shows the pavement footway waste and the road surface covered by recycling asphalt concrete.

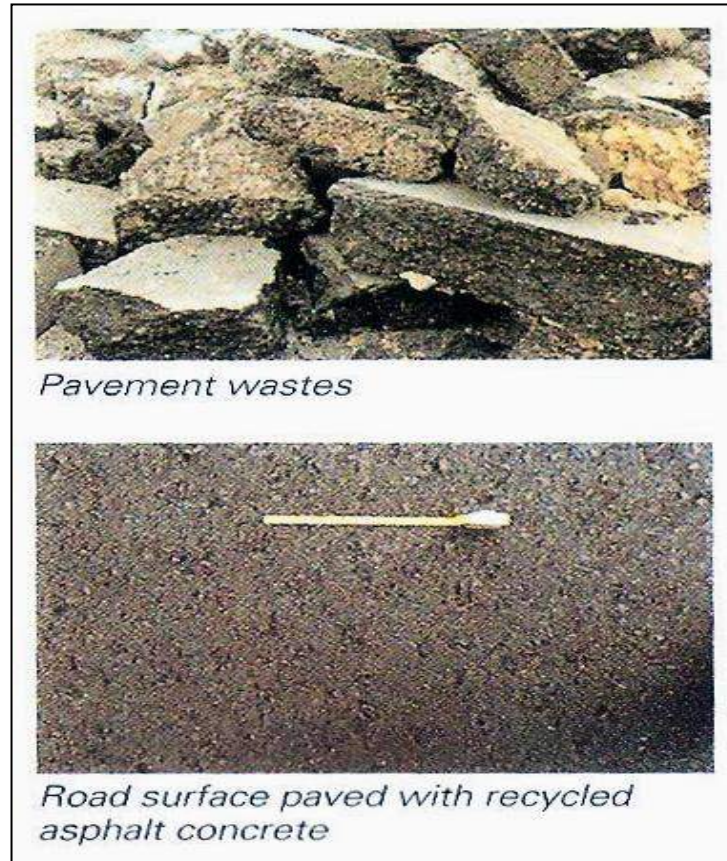


Figure 2.2. Pavement Wastes and Road Surface Paved with Recycled AC  
(National Construction Development Institution, 2013)

The flow chart of asphalt pavement waste recycling in treatment plants can be showed in Figure 2.3

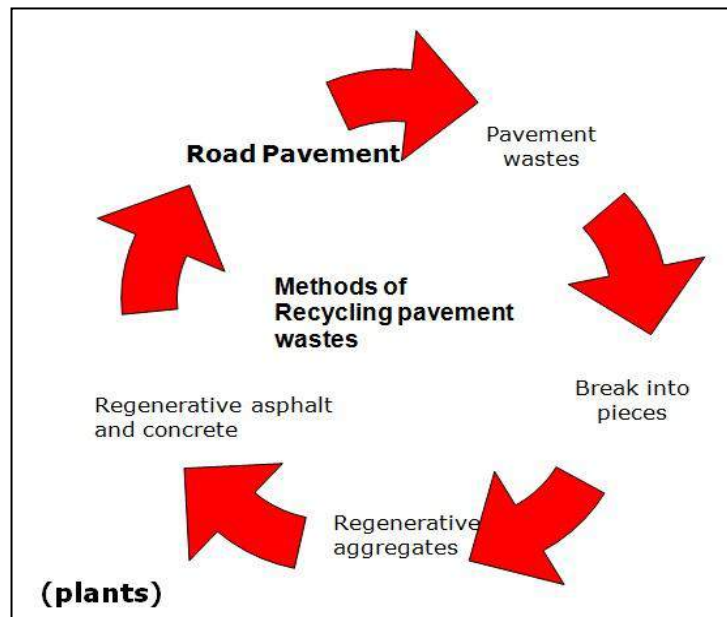




Figure 2.3. The Flow Chart of Asphalt Pavement Waste Recycling in Treatment Plants  
(National Construction Development Institution, 2013)

Some recycling techniques recognized is implementing recycling in the field (in place) and in the mixed place (in plant):

1. In the field (in place), such as dredging, construction and compaction in place;
2. In the mixed placed (*in plant*), the dredging material is taken to the mixed plant to fix the properties. The thick of the pavement coarse needed will be adjusted.

Recycling type choosing should consider some factors such as the surface condition, traffic, and the availability of construction equipment chosen. The construction of pavement recycling covering by cold milling by foam bitu must meet the requirements and specifications determined such as:

1. Indirect Tensile Strength (ITS), minimal 300 kPa;
2. Tensile Strength Retained (TSR), minimal 80%;
3. Unconfined Compressive Strength (UCS), minimal 700 kPa.

The condition will be reached easily if the asphalt used is pen 80/100 and the minimal compaction is 20 ton (static), the filler is more than 15%. Figure 2.4 shows the recycling process in Japan.

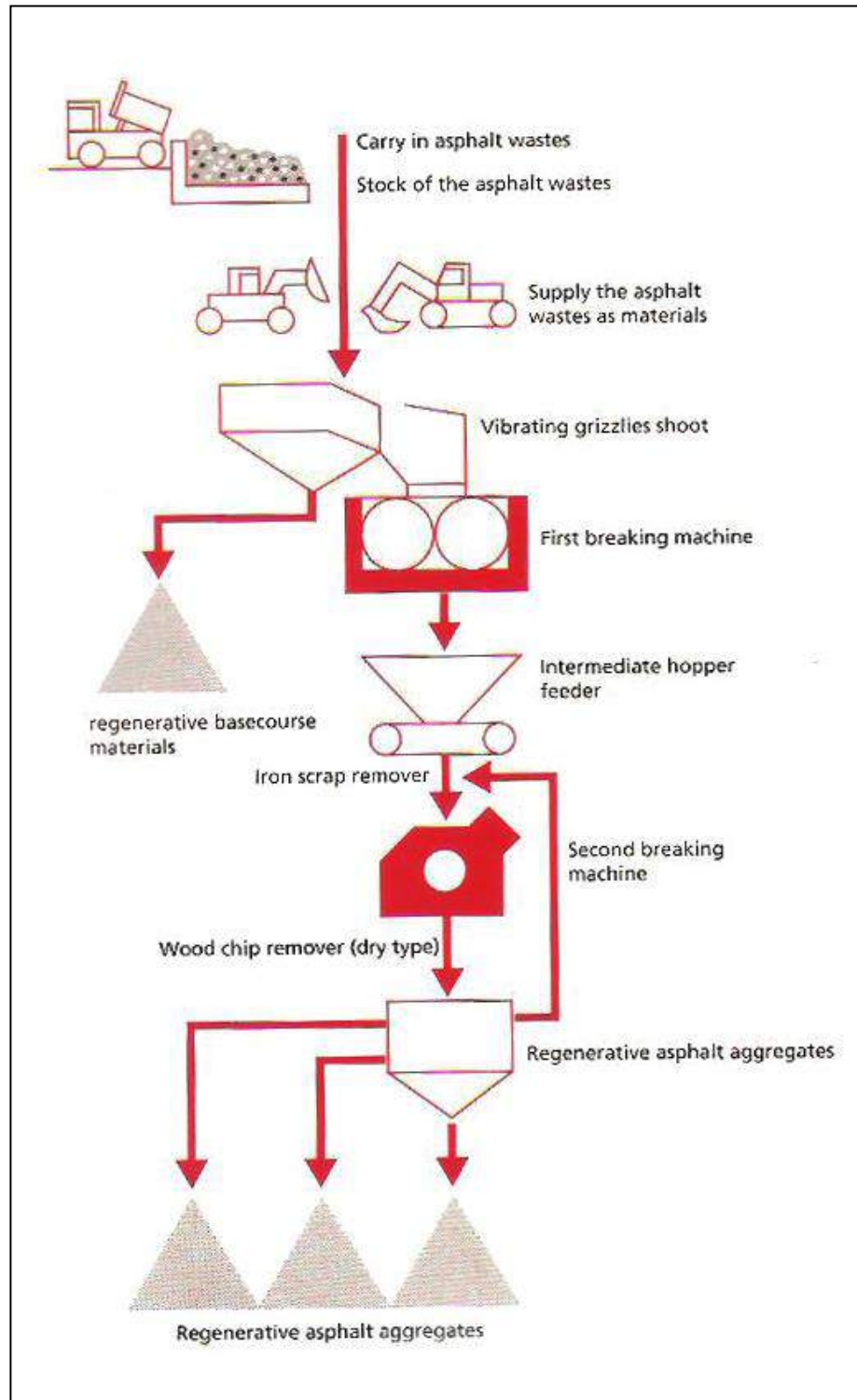


Figure 2.4. The Overseas Construction Association of Japan, Inc  
(National Construction Development Institution, 2013)

## 2.7. Cost and Budget Estimation

According to Soeharto (1995), cost estimation is distinguished from the budget in limitation cost estimation to tabulate the project particular activity or the project overall activity. The budget is the detail planning to estimate the cost of the part or the total of the project activity related to the time (time-phased).

The definition of cost estimation according to National Estimating Society – USA is the art to estimate (the art of approximating) the possibility of total cost required for an activity that is based on the information available at that time (Soeharto, 1995).

The American Association of Cost Engineer (AACE) in Soeharto (1995) gives a definition of cost engineering is an area of engineering activities in which experience and engineering judgment is used in the application of the engineering principles and science in cost estimation and cost control problems.

In the analysis of the fee and material, *Bina Marga* (Government Highways Institutions, 1995) list the coefficients indicating the amount of material and labor needed to finish the construction work per volume. The budgeting components in the maintenance project include equipment, labor, material, and other expanses that have the important roles in controlling project implementation and as well as the tax paid related to the project construction. All of these costs are named the overhead and usually mention in percentage to the direct cost and the amount is not more than 10%, excluding 10% of PPN. The company's profit is also mentioned in percentage to the direct cost and the amount is also not more than 10%.

To get the effectivity and efficiently of the work, the components of equipment, labor, and materials are needed to be analyzed. Unit price is the total amount of the costs expended to complete a work.

Unit price = cost (equipment + labor + material) + other expanses .....(2.1)

## III. RESEARCH METHODOLOGY

### 3.1. Pavement Recycling

Implementation of recycling technology is done by using in place method (done in the field). Implementation technique is done by reconstructing the base course which the thick is approximately 25 cm. As for the upper coarse (sub base course) that is approximately 20 cm is rejuvenated by using the method of cold mix recycling by foamed bitumen base, which recycles Reclaimed Asphalt Pavement (RAP) materials by adding bitumen binder. Then it covered by Asphalt Concrete (AC) or Binder Course (BC) which thick is 6 cm and as the wear layer using Asphalt Concrete or Wearing Course (WC) which thick is 4 cm.

Implementation process of cement treated base recycling begins by dredging the asphalt pavement using *cold milling machine* milling machine with dredging thickness is about 20 cm. Then the dredging material of reclaimed asphalt pavement are collected in the stock pile for recycling using technology of cold mix recycling by foamed bitumen base. Then the sub base course reconstructed by spreading to concrete material evenly (with levels of about 4 percent) on the surface that has been in cold milling.

The compaction process carries out in three phases. The first phase is breakdown using smooth drum vibratory roller with active vibrator in 4 passing and the adding the water *content*. The third phase is finishing with the compaction activity using pneumatic tire roller 10-12 tons in 3 passing. After the compaction process is completed then it is allowed for 2 x 24 hours to wait for the construction process of cold mix recycling by foamed bitumen base.

For cold mix recycling by foamed bitumen base process, beginning with reclaimed asphalt pavement spreading before milling that have been collected in the stock pile in the upper layer of cement treated before recycling base. Determining the road elevation is used the motor grader until 23 cm of the thickness. Then the compaction is done to the reclaimed asphalt pavement layer by using smooth drum vibratory roller 20 tons until 20 cm of the thickness. On the compaction then spreading the concrete evenly (with the cement content is 1%). Then mixing and addition of the asphalt must be maintained at a maximum temperature of 180°C with asphalt content is 2.5 percent and water content is 3-4 percent.

The product of the mixing process is the mixture of reclaimed asphalt pavement materials, cement and foamed bitumen, and then sampled for laboratory test before compaction process. The compaction process carries out in three phases. Breakdown phase using pneumatic tire roller 10-12 tonnes, with the compaction that foamed bitumen material will not stick in the vibratory roller drum. The compaction is in 3 passing and addition of the water content is done in 3 times the passing and the addition of water content.

### 3.2. Road Repaired Analysis

Intermixing handling analysis that is generally done using cold milling, leveling and patching methods then covered by AC or WC. These methods have not produced the the maximal output and quickly damaged. Because the shear bonding between the previous and the new pavement is very fragile (not consisted). In addition, the previous pavement strength is also not consisted (some is weak and other is strong), so that the weak one will damage. To overcome the road damage because of the intermixing, one of the appropriate handling method is reconstructing sub grade and sub base course by using the recycling technology or by recycling the cold milling mixture with foam bitumen (CM-RFB Base). This method done to rejuvenate the sub grade so the material is more impermeable, more flexible and better strength.

### 3.3. Road Repaired Budget

The data of fee, material and equipment rental using in this budget analysis is the data from Dinas Bina Marga Aceh (Aceh Highways Institution) – Banda Aceh, Aceh Besar and Sabang for Region I in 2015. Road width = 7,00 m; road side width in the both side = 4,00 m.

No	Activity	Unit	Unit Price (Rp)
1	Aggregate sub grade of Class A (15-20)	M3	674,371
2	Aggregate sub grade of Class B (15-20)	M3	688,176
3	Aggregate sub grade of Class B (15-20) of the road side	M3	706,059
4	Band permeable layer	Ltr	16,622
5	Permeable layer	Ltr	16,909
6	<i>Latasirklas</i> A (SS-A)	M2	77,516
7	<i>Latasirklas</i> B (SS-B)	M2	81,692
8	Wearing layer of <i>Laston</i> (AC-WC)	Ton	589,851
9	Inter layer of <i>Laston</i> (AC-BC)	Ton	589,555

## IV. RESULT AND DISCUSSION

The volume and load of the vehicles tend to grow so that requiring the innovation in the road maintenance sector to defend or increase the desain period of the road in giving the good traffic service. We realize that we need the good and strong infrastructure to support the economic growth and the road becomes one of vital parts in the infrastructure. If the

budget is insufficient then we have to obtain the more effective and efficient method of the road rehabilitation. The road improvement by adding the additional course continuously will affect the thickness of the pavement layer become thicker and the material needed become dwindling.

The innovation is needed to find an alternative construction methods that can increase the effectiveness of existing costs usage, by seeking more road rehabilitations than cost expanded. Recycling method is one of the methods to solve this problem. The handling by pavement recycling technology is an alternative to solve this problem because it has several advantages such as can restore the pavement strength and keep the road geometric and also overcome the dependence of the new materials.

Recycling that is processed and supported by the appropriate equipment will produce a mixture which structural value can compensate the new mixture. The addition of new materials and or additional material on old pavement exfoliation material is one of the alternatives to improve the capacity of the former exfoliation.

The condition becomes worse because the high traffic loads create the complex problems. The road constructions which lay in the soft ground contain much particles, base aggregate (base and sub base) can decrease the soil capacity. The overload condition and the road condition in the soft ground can cause road construction failure potential became high enough. Due to vehicle wheel pressure and traffic load vibration into the subgrade, the fine particles will rise to fill the subbase cavities and slowly reach into the base layer and causing intermixing.

AC pavement repairment is done if the pavement layer reaches the final surface index, this pavement repairment is constructed only to cover old pavement with the new one to add the road elevation. The solution is by dredging old pavement surface layer by using cold milling method. The dredgeing materials that is names as Reclaimed Asphalt Pavement (RAP) are not in the small amount so that it is necessary to recycle to pavement material for the environmental sustainability. The problems that need to be solved is how the material as cold milling products can be re-utilizing for recycling the asphalt concrete road pavement, AC type, and the cost needed.

Reutilizing of RAP material is using a drum mixer equipment in which the recycling concept is using hot process and in plant recycling. The cost consideration is highly recommended this recycling asphalt concrete, because recycling asphalt concrete mixture can be one of the alternatives to replace the conventional asphalt concrete and it can cause the significant savings. Recycling asphalt concrete can save 43.5% per ton compared with non-recycled asphalt concrete.

## **V. CONCLUSION AND RECOMMENDATION**

The implementation of recycling technology is quite appropriate if it is used to solve the road damages in Aceh. Besides having several advantages, it also has the damage characteristic that is suitable to be repaired by using this technology.

This recycling technology implementation is economized enough both in cost factor and the technical accuracy factor. The application of this technology can save material using, environmental friendly and quite good technical product so that it can be developed to overcome the damages in the road sections.

By applying the recycling technologies, the need of the new materials can be minimized. Other positive impacts are competitive construction cost and the reduction of traffic load on the existing road because of the material transportation. Finally by using this asphalt recycling, it is expected to overcome the road damages occurring and the quality of the road in Aceh becomes better in the future.

## References

- Anonymous. (2013). *Perkerasan Aspal Jalan Daur Ulang (Recycling)*. Lembaga Pengembangan Jasa Konstruksi (LPJK), Indonesia.
- Anonymous. (2015). *Keputusan Gubernur Aceh Nomor: 028/827/2014 Tentang Penetapan Harga Satuan Bahan Bangunan/Satuan Pekerjaan dan Jasa Kebutuhan Pemerintah Aceh*. Dinas Pendapatan dan Kekayaan Aceh.
- Arikunto, S. (1997). *Prosedur Penelitian – Suatu Pendekatan Praktek (Edisi Revisi V)*. Jakarta: Rineka Cipta.
- Faozan, M. A. (2013). *Recycling Aspal untuk Perbaikan Jalan*. <http://litbang.pu.go.id/recycling-teknologi-daur-ulang-perkerasan-jalan.balitbang.pu.go.id>
- Kodoatie, R. J. (2003). *Pengantar Manajemen Infrastruktur*. Yogyakarta: Pustaka Pelajar.
- Mahendra, S. (2004). *Manajemen Proyek*. Jakarta: Gramedia Pustaka.
- Nazir, M. (2011). *Metode Penelitian*. Bandung: Ghalia Indonesia.
- Soeharto, I. (1995). *Manajemen Proyek – Dari Konseptual Sampai Operasional*. Jakarta: Erlangga.
- Sukirman, S. (1999). *Perkerasan Lentur Jalan Raya*. Bandung: Nova.
- Suwantoro. (2013). *Optimalisasi Penggunaan Material Hasil Cold Milling untuk Daur Ulang Lapisan Perkerasan Jalan Beton Aspal Type AC (Asphalt Concrete)*.

## Acknowledgement

I, the undersigned below, DR. HAFNIDAR A. RANI hereby states that:

1. In my reserach, there is no a part or all part that I adopted from other researches without mentioning the resources that can be acted as a plagiarism.
2. To my knowledge, there is also no reproduction of the research or opinion that have ever been written or publised by others which I mention as if it is my original research.
3. If there is a part of my research that fit with the plagiarism, I do not mind if some part or all part of my research article will be cancelled.

I create this statement with the truth and can be used appropriately.

Banda Aceh, March 30<sup>th</sup> 2014  
Sincerely,

DR. HAFNIDAR A. RANI

# Implementation of Eight Pillars the Total Productive Maintenance at Water Supply Company

<sup>1</sup>Iswandi Idris, <sup>2</sup>Ibrahim & <sup>3</sup>Ruri Aditya Sari

<sup>1</sup>Politeknik LP3I Medan, iswandi.idris@gmail.com, 081375882728

<sup>2</sup>Politeknik LP3I Medan, privatkom@yahoo.com, 082166077575

<sup>3</sup>Politeknik LP3I Medan, ruri.adit@gmail.com, 082277218080

## Abstract

Damage caused to the machine / equipment may occur due to many causes and occur at different times throughout the life of the machine / equipment used. Hence, to prevent and trying to cut the damage that may arise when the production process is running, it takes ways and methods to expect the conduct maintenance of machinery / equipment.

In the development Management of Care, raised a concept or method for maintaining productivity optimization, known as Total Productive Maintenance (TPM). Total Productive Maintenance is one of the maintenance process developed methods to increase productivity in the work area, by making the process more reliable and less wasteful (waste). This method is part of Lean Manufacturing.

The goal of the TPM program is to raise the production value which at the same time, raise the morale of workers and job satisfaction; TPM is a work culture, especially in the field of manufacturing and operations.

TPM is a manufacturing tool that remains applicable in all operations using 8 pillars TPM.

Tirtanadi Water Supply Company with machines and equipment that are already available and ready to use at any time needed in the production process.

Function machinery / equipment used in the production process damaged in line with the decline machinery / equipment, but its useful life can extended to make improvements on a regular basis through a suitable maintenance

Now, Tirtanadi Water Supply Company is in the stage of developing the TPM in all their activities.

The focus of research to explore the TPM in 8 pillars at Water Supply Company namely; autonomous maintenance, planned maintenance, quality maintenance, focused improvement, early equipment management, training and education, safety, health and environment, the TPM in administration.

**Keywords:** *Total Productive Maintenance, 8 pillars TPM, water supply*

## Introduction

Tirtanadi water supply Company with machines and equipment that are already available and ready to use at any time needed in the production process. Function machinery / equipment used in the production process damaged in line with the decline machinery / equipment ability, but its useful life can extended to make improvements on a regular basis through a proper maintenance activities.

Total Productive Maintenance or TPM is the maintenance process developed methods to increase productivity in the work area, by making the process more reliable and less wasteful (waste). This method is part of Lean Manufacturing.

TPM serves to support plant and equipment to keep it in prime condition. To meet this goal, the necessary preventive and predictive maintenance. We can applying the principles of TPM we can cut the damage to the machine. A common problem in such a dirty engine, nuts and bolts missing, oil rarely replaced, leaks, sounds abnormal, excessive vibration, the filter is dirty, and so one be minimized by the TPM.

TPM basically has goal: Zero Breakdown, Zero Defect, Zero Accident, with an emphasis on philosophy and cultural improvements continue to occur. TPM has a five S foundation, above the foundation five S are eight Pillar TPM, namely: Autonomous Maintenance, Plant Maintenance, Focused Improvement, Quality Maintenance, Early Product & Machine Management, Training and Health Safety Environment, TPM in Office (Administration). To eight pillar implemented fully to create a cultural change. With a strong commitment from top management, especially as a Change

Management Agent, within a period of 2-3 years we will see a very different manufacturing activities and much more productive.

### Material and Methods

The research conducted in Tirtanadi water supply company - Sunggal water treatment plant, Medan-Indonesia, parameters observed / measured: Maintenance Prevention (MP), Maintainability Improvement (MI), Preventive Maintenance (PM). The method of the data collection is through observation, interviews, questionnaires and physical measurements. Population in this study is Operator, Technician, Staff, analysis, Assistant, Head of Section, the samples were 21 people.

The model used:

1. Autonomous Maintenance
2. Planned Maintenance
3. Quality Maintenance
4. Focused Improvement
5. Early Equipment Management
6. Training and Education
7. Safety, Health and Environment
8. TPM in Administration / office TPM

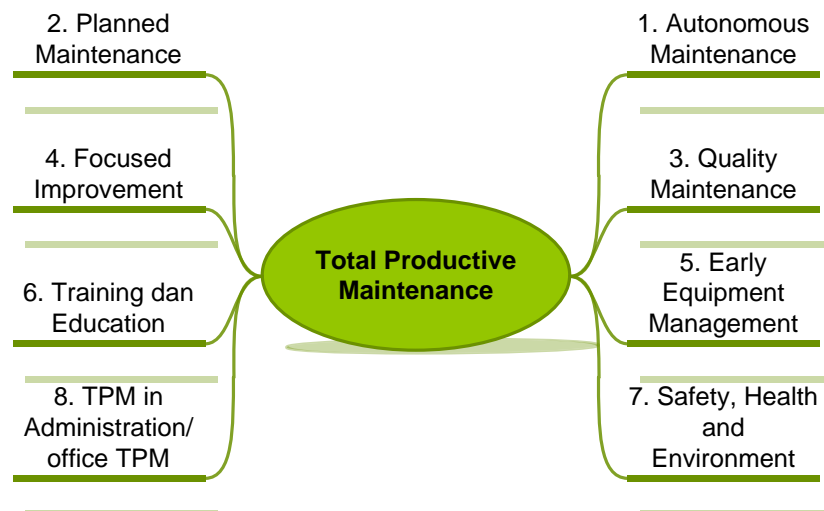


Figure 1. The Eight Pillars TPM

### Result and Discussions

Determine condition of the TPM, the assessment of TPM condition, TPM with a reference assessment questionnaire using sampling methods. Each response asses by adopting a model of a five-point Likert scale items, namely (1) strongly disagree, (2) Disagree, (3) Neutral, (4) Agree, and (5) Strongly agree

#### 1. Autonomous Maintenance

Autonomous Maintenance is a set of maintenance activities undertaken by production operators to set up machinery and equipment independently and do not depend on the technician.

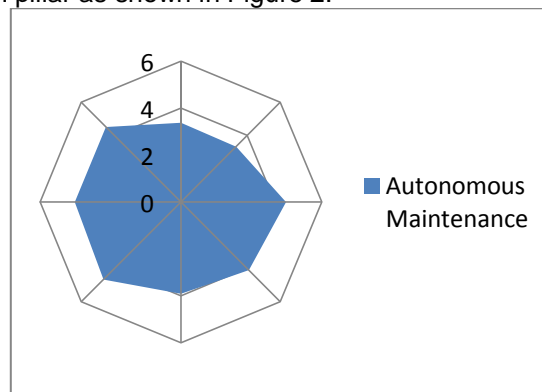
Operators perform maintenance under the time schedule and under the instruction document maintenance work. All the results of the maintenance recording type stored.

The lubrication / oil and periodic machine inspections, the operator has knowledge of the equipment used to find the potential damage before the damage is more severe, their preparation from the transfer of maintenance work in a planned maintenance to the operator, standard operation procedure (SOP) treatment which includes a / parts, methods, tools and period / time. Equipment / machinery have user guide, visual control and support facilities, also the monitoring device / direct supervision.

However, in practice the operator is not given full responsibility for routine maintenance such as cleaning the machine. Application of autonomous maintenance pillar is about 82.3%, or an average



score of 4.1 on a scale of 5. The results of the analysis of the questionnaire obtained data on implementation of first TPM pillar as shown in Figure 2:



**Figure 2.** Autonomous maintenance spider

## 2. Planned Maintenance

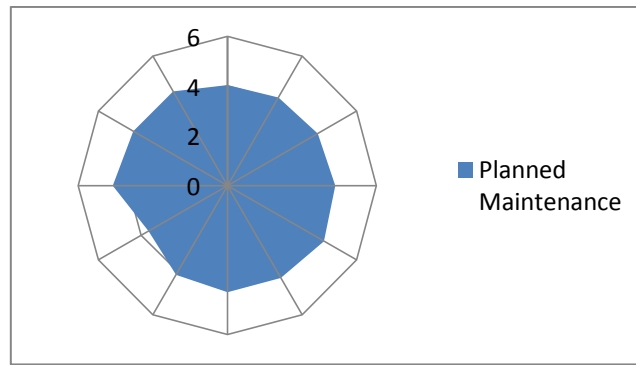
In general, planned maintenance activities classified into two, namely preventive maintenance and predictive maintenance. Both types done in a planned maintenance.

Tirtanadi water supply company - Sunggal water treatment plant has done preventive maintenance, predictive maintenance and care after being damaged. Preventive maintenance and predictive maintenance carried out based on the instructions contained raw role in SOP (standard operating procedure). The treatment by a regular maintenance schedule daily, weekly, monthly, three monthly, six monthly, and yearly. In addition, there is also a history of the equipment or equipment card history. Scheduling maintenance tasks based on the ratio of damage that have occurred and / or the predicted damage level, damage to the machine or tool can suddenly be reduced, the engine guaranteed 100% ready for use, the machine supports consistent quality achievement, the proper number of products and timeliness for customers, implementing preventive maintenance schedule for ease of maintenance and implementation of prevention measures, control the level of damage to the components already much better. The company has equipment that can detect faults early as (methods, tools, oil / lubrication, parts, etc.). Implementation maintenance carried out by the agreed schedule. Daily, weekly and monthly existence as portrait of the current environment. Tool vibration and audio spectrum analyzer or a tool to check the vibration and noise of a machine tools used in the treatment. Have a sound level meter tool or noise meter used to measure noise intensity in the workplace. However, planned maintenance implementation is still not involving operators in maintenance activities and give a small part for the operator.

Although routine maintenance, but not yet followed by providing maintenance reports, records maintainability improvement, and maintenance costs management records so that management can decide machinery and equipment performance. Form label goods for items not specified least amount of stock based on the real conditions and have not done the calculations are correct and scientifically to decide the smallest number of stocks in each kind of spare parts. In the warehouse of spare parts used there is no label or mark whether the conditions of the spare part is suitable to used or not and has not been neatly arranged.

Sunggal water treatment plant cannot know the extent to which the level of productivity of machinery and equipment for OEE and has not calculated the total cost incurred for the maintenance and repair of the machine so that it can have an impact on the budget inaccuracy in determining the cost of care for the next period.

Implementation of planned maintenance pillar is 84.8%, or an average of 4.24 out of 5. The scale application the results of the analysis of the questionnaire obtained data on TPM pillar two implementation shows that figure 3:

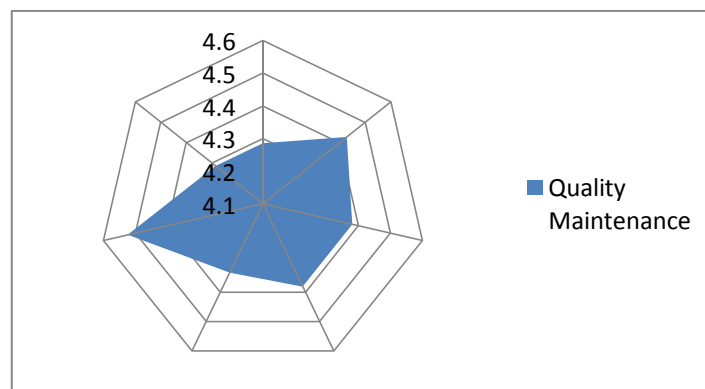


**Figure 3.** Planned maintenance spider

**3. Quality Maintenance**

Quality maintenance is to seek clarity among quality, machines, and human (QMP). It aims to: keep up both the engine to 100% without damage and produce a product without defects or 100% good from the results of research, interviews and questionnaires obtained results that the company has equipment that is reliable in producing products by the specifications of the first time. Always support and organize a good shape to do zero defect, precision tools, process conditions and methods / personal is the standard applied in the company to make zero defect. Evaluation and improvement of the quality and control damage to the engine performance, an effective preventive maintenance system implementation in cost and a timely. Implement an early error detection (mistake proofing).

But there is drawbacks equipment or quality of production machines to detect and prevent errors during ongoing production increased. The application of third pillar is 87.5% or an average score of 4.37 out of a scale of 5. The analysis quality maintenance implementation of questionnaire obtained data on of third pillar shows that figure 4:



**Figure 4.** Quality maintenance spider

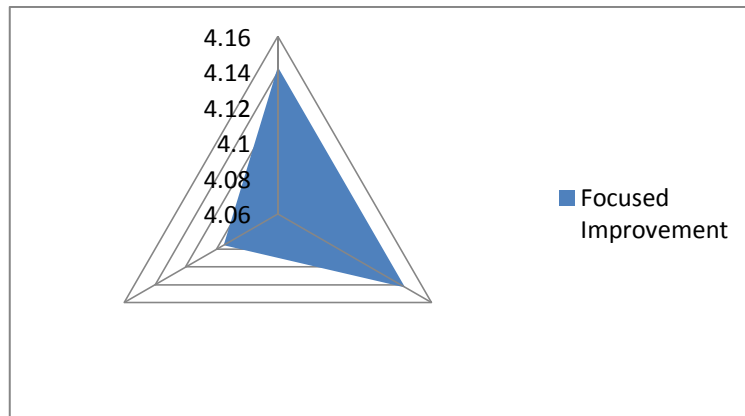
**4. Focused Improvement**

Tirtanadi water supply company - Sunggal water treatment plant have planned treatment, ranging from preventive, predictive, and breakdown maintenance, is clear from the working group presence that proactively identifies machinery / equipment is problematic work and offer solutions or suggestions for improvement, the working group is employees talent in support of the company's performance to meet its goals.

But the drawback is not maximized in implementing five S such as: Sort (Eliminate anything that is not truly needed in the work area), Set in order (Organize the remaining items), Shine (clean and inspect the work area), Standardize (create standards for performing the above three activities), Sustain (Ensure the standards are regularly applied).

The effectiveness and efficiency of its implementation have not been evaluated focused. The application is already running about 82.5%, or an average score of 4.12 on a scale of 5, workplace accidents still occur, although very rare.

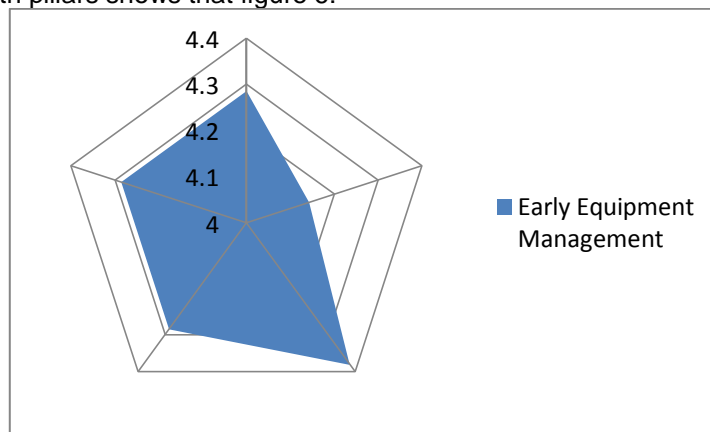
Application the pillar four shows that figure 5.



**Figure 5.** Focused improvement spider

### 5. Early Equipment Management

Tirtanadi water supply company - Sunggal water treatment plant never made added new products. The only products manufactured are the product of clean water for people's daily needs. So there has never been a new type of engine or engine changes with significant changes. From the results of research, interviews and questionnaires obtained results that the company collection of experiences from earlier repair and maintenance activities to make sure the machine can meet optimal performance is always used as a reference and reference, equipment specifications and technical data are always checked, learn the weaknesses and shortcomings as corrective measures (life cycle costing), design improvements implementation on the machine plugged in and future investment possibility, ease of manufacture of machinery / equipment work, ease of installation, ease of process, ease of process control and quality assurance of products and consistent quality output. But machines or production equipment has not been able to meet optimal performance in the shortest possible time because many rely on the old machine, the company has not set a standard method in calculating the productive period of the machine so that at any age can used with the machine still consider aspects - aspects of cost issued if you have to spend money to invest in new machines. Application fifth pillar is about 85.5%, or an average score of 4.27 out of a scale of 5. Application of the fifth pillars shows that figure 6:

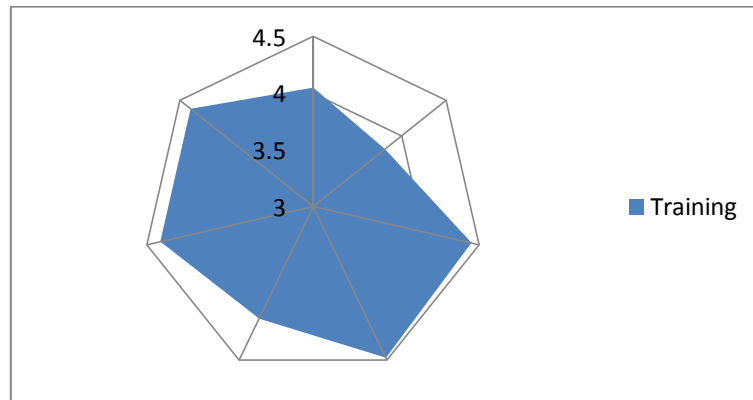


**Figure 6.** Early equipment management spider

### 6. Training and Education

Tirtanadi water supply company - Sunggal water treatment plant has had an annual training program in its implementation together with taps Tirtanadi center. Get enough training on knowledge tools or machines used as the machine and the main components operation in the works. Labor productivity increased with the training and education that ultimately benefit the company. Operators trained to able to perform basic maintenance activities. Operators motivated to pay personal attention to the normal operation of the machine (sound, speed, heat, indicator gauge, others), technicians trained in terms of improving its ability to perform preventive maintenance and the ability to analyze damage to the machine or working equipment. Training at the managerial level can improve ability managers to guide and educate its workforce (mentoring and coaching skills).

But factor in equipment damage still occurs during the operation, it is due to the company does not yet have a standard method for identification training needs for employees and do not have a standard method for evaluating the level of success of the training that has not been targeted and have not a significant impact on the competence and performance of employees, and the opportunity to get the training has not been evenly distributed to all employees. Application sixth pillar shows in Figure 7:



**Figure 7.** Training and education spider

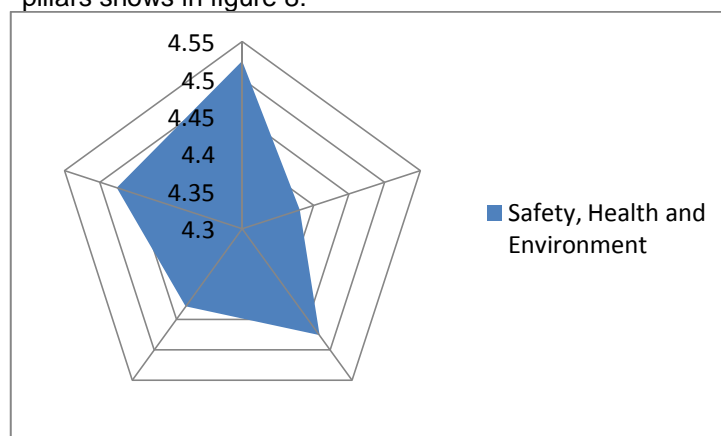
Application the 6<sup>th</sup> pillar is about 84,6 % or an average score of 4,23 out of a scale of 5.

### 7. Safety, Health and Environment

Tirtanadi water supply company - Sunggal water treatment plant is a company that produces drinking water. In the production process and to see the conditions of the work environment, workplace accident had never happened very significant. Sunggal water treatment plant has provided safety equipment such as safety shoes, helmets, masks, and other safety equipment.

Some areas of work that require safety equipment and workplace accidents are likely to occur altitude work sites from the mainland, leakage of substances chlorine chance. Successful implementation of 5S seen where workers can work and it able to perform its functions in a safe and healthy environment, the company has provided environmentally safe and healthy and free from hazardous conditions, Occupational Health and Safety (OHS) is sufficient equipment provided by the company, has a workplace that "accident free" (a workplace free of all accidents), always use personal protective equipment (PPE) such as helmet, shoes standards, etc. when the inspection to the field. Sunggal water treatment plant has obtained certification of environmental management systems integration ISO 14001: 2004 quality management system ISO 9001: 2000 that has noticed the condition aspects of work environment.

Although it has had safety equipment, but taps Sunggal water treatment plant not get or implement certificate occupational health and safety systems and OHSAS 18001: 2007 (occupational, health, safety assessment). Application 7<sup>th</sup> pillar is about 89.1%, or an average score of 4.46 on a scale of 5. Application of the 7<sup>th</sup> pillars shows in figure 8:



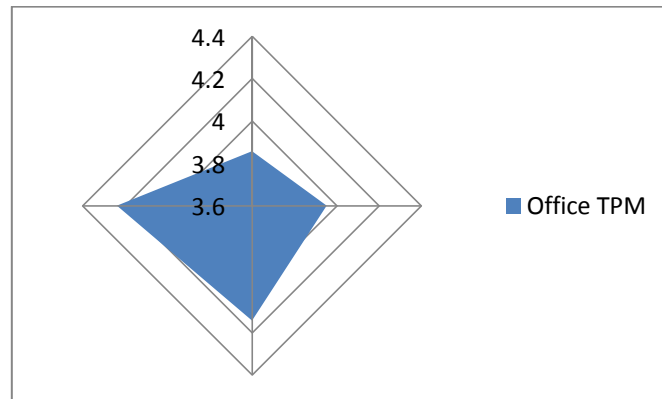
**Figure 8.** Safety, health and environment spider

### 8. TPM in Administration/ office TPM

Tirtanadi water supply company - Sunggal water treatment plants not perform maintenance on office equipment alone, but collaborate with center taps Tirtanadi division field of computer and communication equipment maintenance. From the results of the questionnaire are known already efficient office activities and any damages that may occur can minimized at an early stage, the entire department that supports the production process, product delivery and customer service actively participate in TPM activities to improve the effectiveness of business performance

But employees do not understand the concept and perception of TPM in administrative and management functions less socializing TPM concept to employees. Sunggal water treatment plant not evaluate the maintenance and repair yet processes implement for office equipment from the aspect of quality of work, quantity, time of execution and costs due to maintenance and repair.

Application 8<sup>th</sup> pillar is about 81%, or an average score of four on a scale of 5. Application 8<sup>th</sup> pillar shows in figure 9:



**Figure 9.** TPM in administration/ office TPM spider

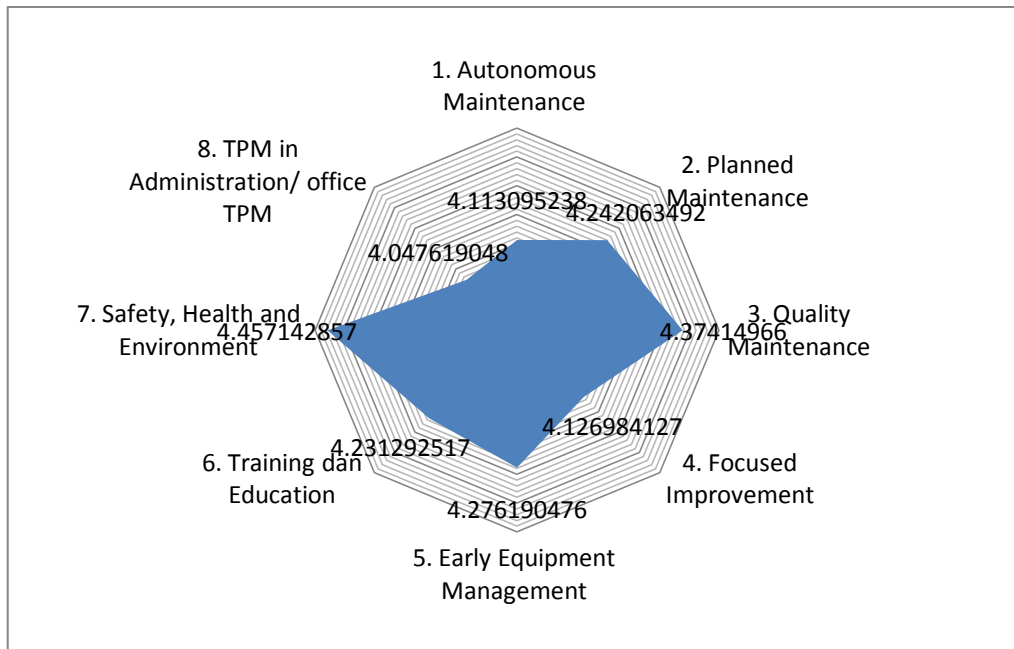
### The Eight Pillars TPM

From the analysis of the questionnaire obtained data on start of TPM implementation of eight Pillars shows in Table 1 :

Table 1 application of the eight pillars of TPM

8 pillars TPM	Score	Percentage
1. Autonomous Maintenance	4.113095	82.26%
2. Planned Maintenance	4.242063	84.84%
3. Quality Maintenance	4.37415	87.48%
4. Focused Improvement	4.126984	82.54%
5. Early Equipment Management	4.27619	85.52%
6. Training dan Education	4.231293	85.52%
7. Safety, Health and Environment	4.457143	89.14%
8. TPM in Administration/ office TPM	4.047619	80.95%
average	4.233567	84.78%

From Table one we get the average implementation of TPM is 84.78%. Spinner from eight pillars TPM use in the taps seen in Figure 10:



**Figure 10.** Eight pillars TPM spider

### Conclusion

Based on the results, it can concluded that the taps of Sunggal water treatment plant has implemented the TPM (Total Productive Maintenance) amounted to 84.78%. Low application of TPM is in administration / office TPM 80.95% and 82.26% autonomous maintenance and improvement focused 82.54%

### Recommendation

1. Should evaluated maintenance and repair processes carry out for the Office equipment, ranging from aspects of quality of work, measure, time of execution and costs due to maintenance and repair. So as to provide feedback on performance Tirtanadi water supply company - Central Division because taps Sunggal water treatment plant is one of the customers of Tirtanadi water supply company.
2. Tirtanadi should have a standardized method identify training needs for employees and have a standard method for evaluating the level of success of the training does have the right target and whether it has significant impact on the competence and performance of employees, and if the opportunity to get training evenly to all employees. One method that can be used is to study and implement the ISO 10015: 2005 is about designing Training System.
3. Tirtanadi should recommend standard methods in calculating the productive period of the machine so that at any age can used with the machine still consider aspects - aspects of the costs incurred if you have to spend money to invest in new machines. One way to use the principles of engineering economy.
4. OEE calculation and total costs incurred for the maintenance and repair of the machine in order to assess the level of productivity of machines and tools that can have an impact on the budget inaccuracy in determining the cost of care for the next period.
5. In the warehouse of spare parts that use labeled or sign condition of spare parts is still worth taking or not and must re-layout back arrangement so neat.
6. Ensure that the Form Label Stock Items for items minimum amount charged based on the actual conditions and perform accurate and scientific calculations to determine the minimum amount Stock on each kind of spare parts. There are several methods that can be used, namely:
  - a. Material Requirement Planning (MRP)
  - b. Re-Order Point (for difficult spare part)
  - c. Salvage Part (re-condition or re-use part)

7. Provide Maintenance Reports, Maintainability Improvement Records, and Maintenance Cost Record in management so that management can determine the perform machines and equipment.
8. We recommend that you perform a planned process Focused Improvement

### References

- Ahuja, I.P.S. and Khamba, J.S. (2008), "Total productive maintenance: literature review and directions", *International Journal of Quality and Reliability Management*, Vol. 25 No. 7, pp. 709-756.
- Altman, D.G., Machini, D., Bryant, T.N. & Gardner, M.J., (2000). *Statistics with Confidence*. 2nd ed. London.
- Assauri, Sofyan., ( 1980) *Manajemen Produksi*, Edisi Ketiga, Lembaga Penerbit Fakultas Ekonomi Universitas Indonesia, Jakarta, p. 88
- Ireland, F. and Dale, B.G., (2001), "A study of total productive maintenance implementation", *Journal of Quality in Maintenance Engineering*, Vol 7, pp.183-191.
- Leflar, James A., (2001) *Practical TPM, Successful Equipment at Agile Technologies*, Productivity Press, Portland, Oregon, p.18
- Nakazima, S., (1998), *Introduction to TPM*, Productivity Press, Cambridge Massachusetts.
- Nakazima, S., (1998), *TPM, Development Program, Implementing Total Productive Maintenance*, Productivity Press, Cambridge Massachusetts.
- Roy K. Davis., (1995), *Productivity Improvement Through TPM*.
- Tajiri, M. And Gotoh, F. (1992). *TPM Implementation– A Japanese Approach*. McGraw Hill, Inc.
- Takahasi, Yoshikazu, Osada, Takashi, (1990), *Total Productive Maintenance*, Asian Productivity Organization.
- Lean production (2015), TPM – Total Productive Maintenance, <http://www.leanproduction.com/tpm.html>

## Solar Radiation Estimation Using Hargreaves Model For Required Data of Photovoltaic Power Generation in Perlis

<sup>1</sup> M. Irwanto, <sup>2</sup> F. Malek, <sup>3</sup> M. Masri, <sup>4</sup> H. Alam, <sup>5</sup> N. Gomesh, <sup>6</sup> Y.M. Irwan & <sup>7</sup> Suhelmi

<sup>1,2,3,4,5,6</sup> Centre of Excellence for Renewable Energy (CERE) Department, School of Electrical System Engineering, Universiti Malaysia Perlis (UniMAP), Perlis, Malaysia,  
irwanto@unimap.edu.my, mfareq@unimap.edu.my, masrimahrizal@yahoo.com,  
hermans\_itm@yahoo.co.id, gomesh@unimap.edu.my, irwanyusoff@unimap.edu.my,  
arnomed@yahoo.com

<sup>1,3,4,7</sup> Department of Electrical Engineering, Medan Institute of Technology, Medan, Indonesia

### Abstract.

Based on Meteorological Station in Chuping Perlis, there is missing data of solar radiation for the year of 2007 and 2008. This paper presents to estimate the solar radiation using Hargreaves model. The estimation based on latitude and daily minimum and maximum temperature in perlis. As validation, the measured and estimated solar radiation data were compared for the year of 2006 and analyzed using coefficient of residual mass (CRM), root mean squared error (RMSE), Nash-Sutcliffe equation (NSE) and percentage error (e), its result shown that the value of CRM is 0.09, it indicates the tendency of the estimation model to under-estimate the measured solar radiation. The value of RMSE is 20.18 %. The value of NSE is 0.03, it is steel far to close to 1. The value of e is 4.08 %, it indicates that the model estimation is acceptable. The minimum, maximum and average daily estimated solar radiation throughout the year of 2008 was 5.06 MJ/m<sup>2</sup> on 24 November, 20.20 MJ/m<sup>2</sup> on 22 February and 16.25 MJ/m<sup>2</sup>, respectively. The total estimated solar radiation in a year was 5.95 GJ/m<sup>2</sup>.

**Keywords:** solar irradiance; temperature; Hargreaves model; photovoltaic; statistical analysis.

## 1 Introduction

Solar radiation is a primary driver for many physics, chemical and biology processes on the earth's surface, and complete and accurate solar radiation data at a specific region are of considerable significance for such research and application fields as architecture, industry, agriculture, environment, hydrology, agrolgy, meteorology, limnology, oceanography, ecology and solar energy system ((Wu [1], Almorox [2]). The solar radiation data is the most important component to estimate output of photovoltaic systems (Markvart [3], Itagaki [4], Mellit [5]).

The best solar radiation data at the place of interest would be that measured at this specific site continuously and accurately over the long term. However, due to financial, maintenance, calibration requirement of the measuring equipment or institutional limitations, these data are absent, incomplete or inaccessible in most areas of the world (Wu [1], Almorox [2], Muneer [6], Yorukoglu [7]).

Based on Meteorological Station in Chuping Perlis, it was not recorded the solar radiation on April 2007 to December 2008. This seriously hinders the progress of much research that requires solar radiation as a key driving input, especially to estimate output of photovoltaic systems. Therefore, various models have been explored in order to estimate, with reasonable accuracy, the solar radiation



from other available meteorological data. One of the models is Hargreaves model which can be applied to estimate the solar radiation in Perlis.

## 2 Methodology

### 2.1 Climate Data

Based on Meteorological Station in Chuping Perlis, Perlis ( 6<sup>o</sup> 29' N , 100<sup>o</sup> 16' E) has about 795 square kilometers land area, 0.24% of the total land area of Malaysia, with a population about 204450 people (Yorukoglu [7]). Perlis's climate is tropical monsoon. Its temperature is relatively uniform within the range of 21°C to 32°C throughout the year. During the months of January to April, the weather is generally dry and warm. Humidity is consistently high on the lowlands ranging between 82% to 86% per annum. The average rainfall per year is 2,032 mm to 2,540 mm and the wettest months are from May to December.

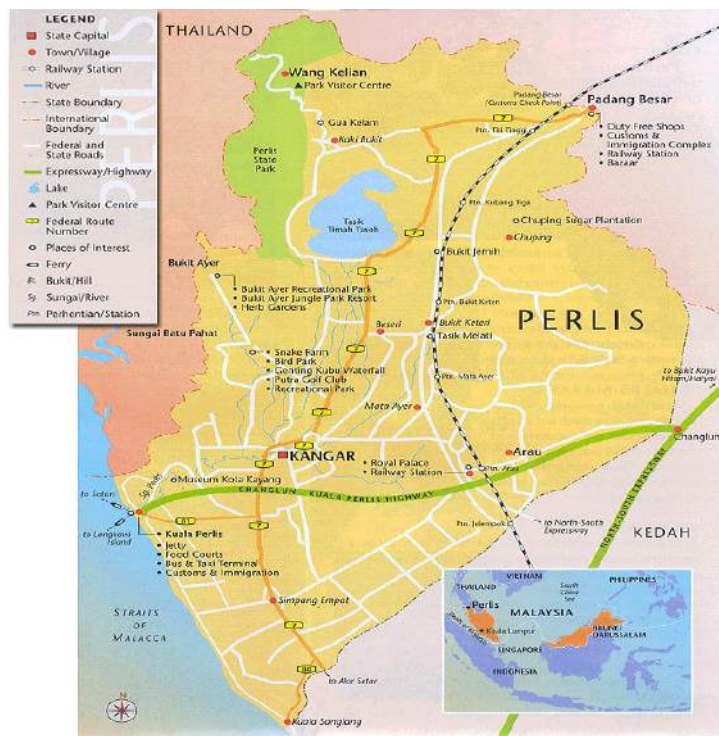


Figure 1 Meteorological Station in Chuping, Perlis used as analysis

The daily meteorological data of Chuping station is used in this research. It consist of daily solar radiation, maximum, minimum and average temperature. The number of missing data and unit of each item for the year of 2006 to 2008 are describe in Table 1.

Table 1 Description of the meteorological data for Chuping station (2006 to 2008)

Item	Missing data (month)		
	2006	2007	2008
Solar radiation (MJ/m <sup>2</sup> )	0	9	12
Maximum temperature (°C)	0	0	0
Minimum temperature (°C)	0	0	0
Average temperature (°C)	0	0	0

There is no missing data for the year of 2006, 9 and 12 months missing data of solar radiation for the year of 2007 and 2008, respectively. Using Hargreaves modelling solar radiation for the year of 2007 and 2008 can be estimated.

## 2.2 Hargreaves Model

Hargreaves and Samani (1985) first suggested that the solar radiation ( $R_s$ ) can be estimated from the difference between maximum and minimum air temperature using a simple equation (Almorox [2], Chineke [8], Bandyopadhyay [9]):

$$R_s = a.R_a(T_{\max} - T_{\min})^{0.5} \quad (1)$$

where  $R_s$  is in  $\text{MJ.m}^{-2}.\text{d}^{-1}$ ;  $T_{\max}$  and  $T_{\min}$  are mean daily maximum and minimum air temperature, in  $^{\circ}\text{C}$ , respectively;  $R_a$  is extraterrestrial radiation, in  $\text{MJ.m}^{-2}.\text{d}^{-1}$  which is a function of latitude and day of the year; and  $a$  is an empirical coefficient, the value of  $a$  to be 0.16 for interior regions and 0.19 for coastal regions.

The value of  $R_a$  is given by

$$R_a = (1440/\pi).SC.DF.(\cos\phi.\cos\delta.\sin W_s + W_s.\sin\phi.\sin\delta) \quad (2)$$

$SC$  is solar constant (  $1367 \text{ W/m}^2$  or  $0.082 \text{ MJ.m}^{-2}.\text{min}^{-1}$ )

$DF$  is eccentricity correction factor of the earth's orbit, can be calculated by the expression :

$$DF = 1.0 + 0.033.\cos(2.\pi.(Julian\ Day/365)) \quad (3)$$

$\phi$  is latitude of the site, can be calculated by the expression :

$$\phi = latitude.\pi/180 \quad (4)$$

$\delta$  is solar declination, can be calculated by the expression :

$$\delta = (23.45.\pi/180).\sin(2.\pi.(284 + Julian\ Day)/365) \quad (5)$$

$W_s$  is mean sunrise hour angle, can be calculated by the expression :

$$W_s = \cos^{-1}(-\tan\phi.\tan\delta) \quad (6)$$

The value of  $R_a$  depends on julian day, and the value of  $R_s$  is proportional to the difference between maximum and minimum air temperature ( $T_d$ ). If the value of  $T_d$  increases, the value of  $R_s$  will increase.

## 2.3 Validation Using Statistical Analysis

The Hargreaves model was validated by using the solar radiation data for the year of 2006 of Meteorological station in Chuping, Perlis. The performance of the model was evaluated on the basic of the following statistical analysis. Then, the missing data of solar radiation for the year of 2008 was estimated by using the Hargreaves model.

Daily estimated solar radiation ( $R_{Sest}$ ) values were compared with measured ( $R_{Smea}$ ) values. To assess the predictive accuracy for daily solar radiation estimation, four performance indicator were

used, namely, coefficient of residual mass (CRM), root mean squared error (RMSE), Nash-Sutcliffe equation (NSE) and percentage error ( $e$ ) expressed as a percentage of the arithmetic mean of the measured solar radiation (Almorox [2], Bandyopadhyay [9], Gavalian [10], Menges [11], Chen [12], Chen [13], Supit [14], Prieto [15]) :

$$CRM = \frac{\sum_{i=1}^n R_{Smea,i} - \sum_{i=1}^n R_{Sest,i}}{\sum_{i=1}^n R_{Smea,i}} \quad (7)$$

where  $R_{Smea,i}$  is the measured daily solar radiation at  $i$  day,  $R_{Sest,i}$  is the estimated daily solar radiation at  $i$  day,  $\overline{R_{Smea}}$  is the average measured solar radiation and  $n$  is the day number of estimated solar radiation.

$CRM$  indicates overall under- or over estimation. For perfect estimation, the value of  $CRM$  would be zero. A positive value of  $CRM$  indicates the tendency of the estimation model to under – estimate the measured solar radiations, whereas, a negative  $CRM$  indicates a tendency to over-estimate the measured solar radiations.

$$RMSE(\%) = \frac{\sqrt{\frac{\sum_{i=1}^n (R_{Sest,i} - R_{Smea,i})^2}{n}}}{\overline{R_{Smea}}} \times 100 \quad (8)$$

$RMSE$  was expressed as percentage to make it dimensionless, a lower value of it indicates better performance.

$$NSE = 1 - \frac{\sum_{i=1}^n (R_{Smea,i} - R_{Sest,i})^2}{\sum_{i=1}^n (R_{Smea,i} - \overline{R_{Smea}})^2} \quad (9)$$

$NSE$  is also known as coefficient of determination ( $R^2$ ), a model is more efficient when  $NSE$  is closer to 1 when all the estimated solar radiations match perfectly with the measured ones. A lower value (close to zero) of  $NSE$  indicates poor performance of the estimation model used and a negative value indicates that the estimated solar radiations are worse than simply using measured mean.

$$e(\%) = \frac{R_{Smea,i} - R_{Sest,i}}{R_{Smea,i}} \times 100 \quad (10)$$

A relative percentage error between -10% and +10% is considered acceptable. The mean percentage error can be defined as the percentage deviation of the estimated and measured monthly average daily solar radiation.

### 3 Results and Discussion

#### 3.1 Temperature and Solar Radiation for the Year of 2006

Solar radiation ( $R_s$ ) is effected by the difference between maximum and minimum air temperature ( $T_d$ ).  $R_s$  is proportional to  $T_d$ , if the value of  $T_d$  increase, so value of  $R_s$  will increase. The temperature throughout the year of 2006 in Perlis is shown in Figure 2. The lowest and average minimum air temperature for the year of 2006 were 19.8 °C on 22 January and 24.03 °C, respectively. The highest and average maximum air temperature were 36.8 °C on 12 March and 32.36 °C, respectively. The lowest, highest and average difference between maximum and minimum air temperature were 2.10 °C on 24 March, 13.20 °C on 22 January and 13 March and 8.33 °C, respectively.

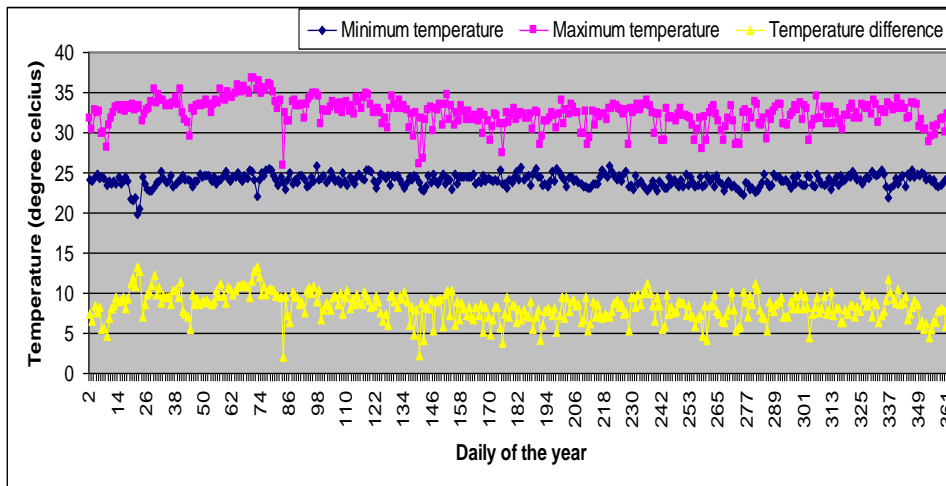
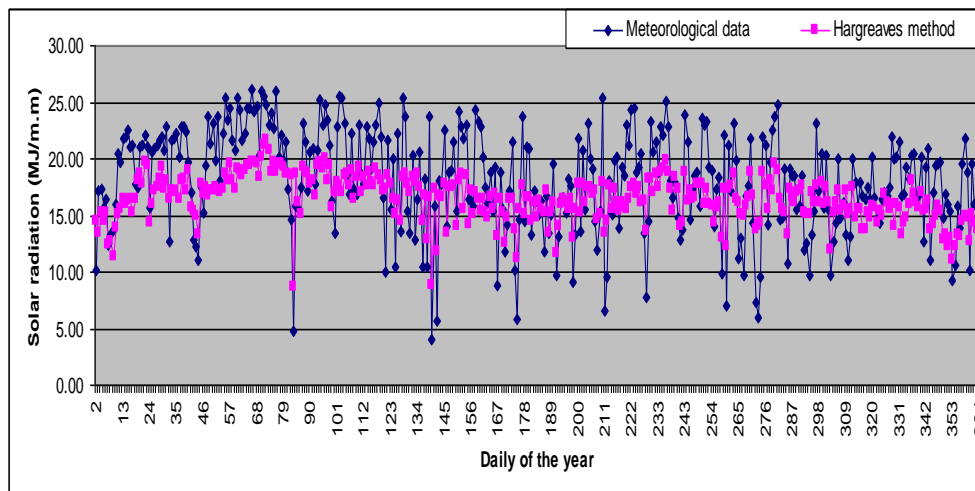


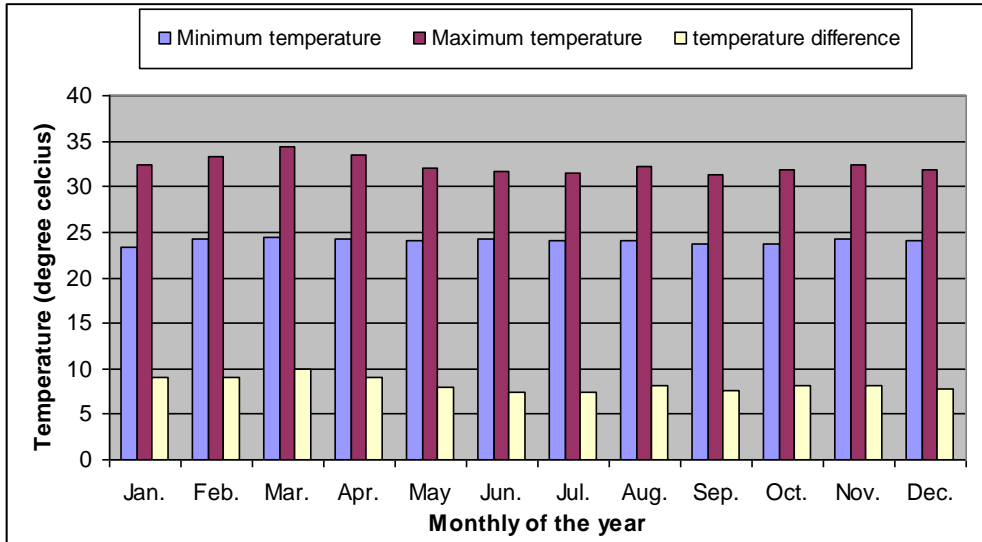
Figure 2 Temperature throughout the year of 2006 in Perlis

Daily measured and estimated solar radiation throughout the year of 2006 are shown in Figure 3. The minimum, maximum and average measured solar radiation was 4.07 MJ/m<sup>2</sup> on 20 May, 26.06 MJ/m<sup>2</sup> on 7 March and 18.11 MJ/m<sup>2</sup>, respectively. The minimum, maximum and average estimated solar radiation was 8.72 MJ/m<sup>2</sup> on 24 March, 21.65 MJ/m<sup>2</sup> on 13 March and 16.44 MJ/m<sup>2</sup>, respectively. The total measured and estimated solar radiation in a year were 6.59 GJ/m<sup>2</sup> and 5.98 GJ/m<sup>2</sup>, respectively.



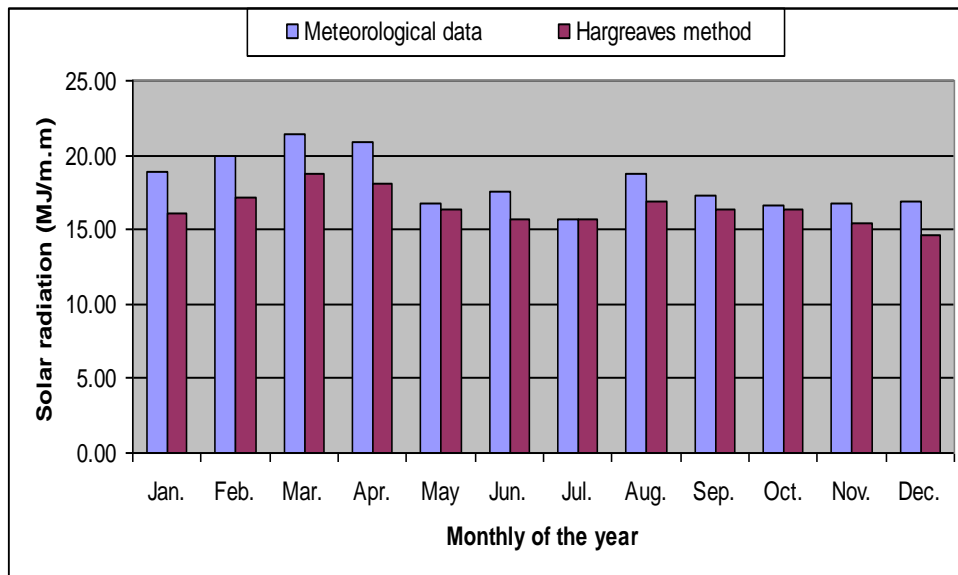
**Figure 3** Daily solar radiation throughout the year of 2006

Monthly average temperature in Perlis for the year of 2006 is shown in Figure 4. The lowest minimum temperature was 23.42 °C on January. The highest maximum temperature was 34.32 °C. The highest temperature difference was 9.98 °C on March.



**Figure 4** Monthly average temperature in Perlis for the year of 2006

Monthly average measured and estimated solar radiation in Perlis for the year of 2006 is shown in Figure 5. The minimum and maximum measured solar radiation were 15.74 MJ/m<sup>2</sup> on July and 21.34 MJ/m<sup>2</sup> on March, respectively. The minimum and maximum estimated solar radiation was 14.62 MJ/m<sup>2</sup> on December and 18.71 MJ/m<sup>2</sup> on March, respectively. On May, July and October the measured and estimated solar radiation were almost same.



**Figure 5** Monthly average solar radiation in Perlis for the year of 2006

### 3.2 Statistical Analysis

The comparison of measured and estimated solar radiation from the daily measured temperature is expressed by *CRM* , *RMSE* , *NSE* and *e* , as shown in Table 2.

Table 2 Comparison of measured and estimated solar radiation from the daily measured temperature

Station	<i>CRM</i>	<i>RMSE (%)</i>	<i>NSE</i>	<i>e (%)</i>
Chuping	0.09	20.18	0.33	4.08

The value of *CRM* is 0.09, it indicates the tendency of the estimation model to under-estimate the measured solar radiation. The value of *RMSE* is 20.18 %. The value of *NSE* is 0.03, it is steel far to close to 1. The value of *e* is 4.08 %, it indicates that the model estimation is acceptable.

### 3.3 Temperature And Solar Radiation for the Year of 2008

Using Hargreaves model , based on the difference between maximum and minimum air temperature, so the solar radiation for the year of 2006 can be estimated. The temperature throughout the year of 2008 in Perlis is shown in Figure 6. The lowest and average minimum air temperature for the year of 2008 were 21.9 °C on 28 July and 23.65 °C, respectively. The highest and average maximum air temperature were 35.6 °C on 27 February and 8 June and 31.83 °C, respectively. The lowest, highest and average difference between maximum and minimum air temperature were 0.9 °C on 24 Nov , 12.20 °C on 22 February and 8.17 °C, respectively.

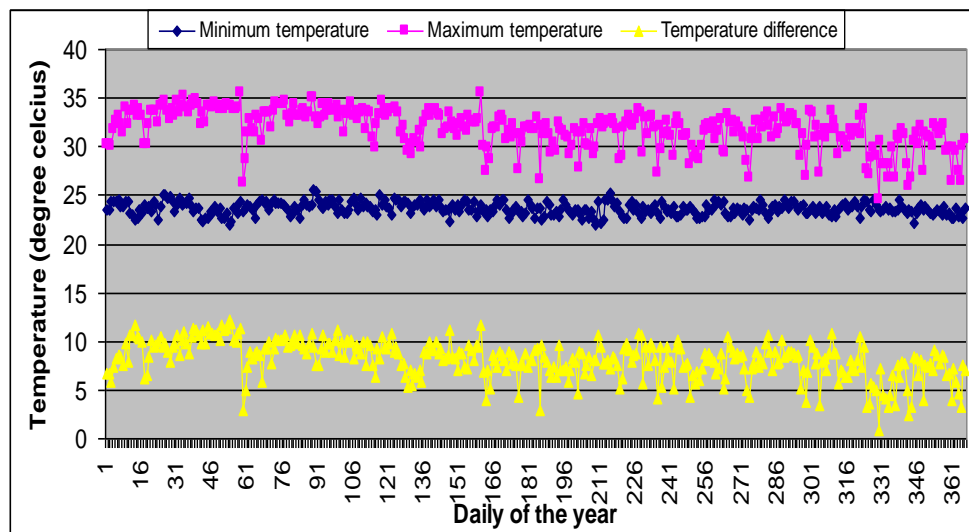
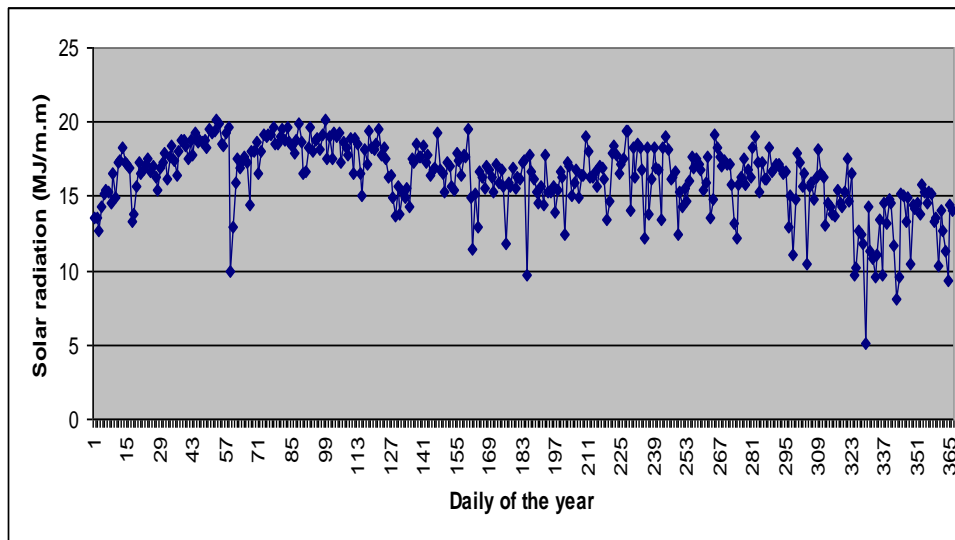


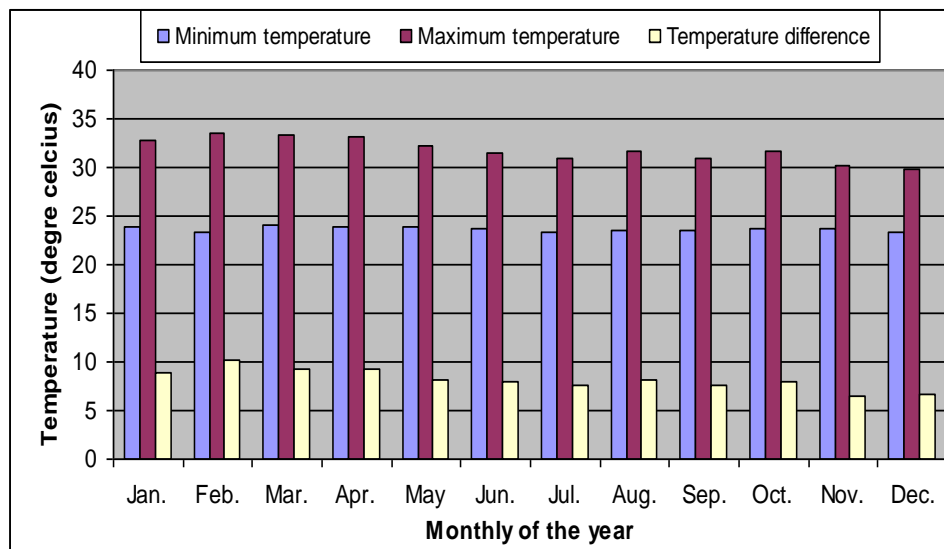
Figure 6 Temperature throughout the year of 2008 in Perlis

Daily estimated solar radiation throughout the year of 2008 shown in Figure 7. The minimum, maximum and average estimated solar radiation was 5.06 MJ/m<sup>2</sup> on 24 November, 20.20 MJ/m<sup>2</sup> on 22 February and 16.25 MJ/m<sup>2</sup>, respectively. The total estimated solar radiation in a year was 5.95 GJ/m<sup>2</sup>.



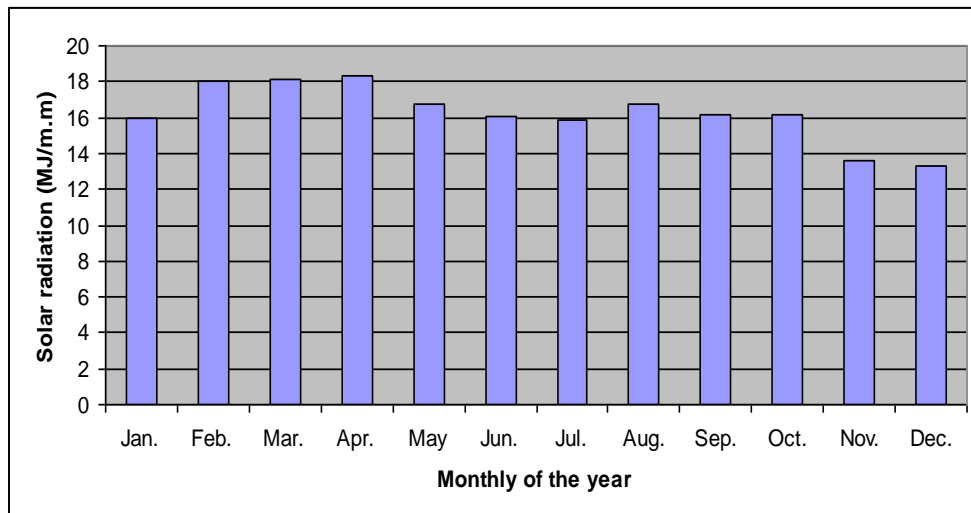
**Figure 7** Daily solar radiation throughout the year of 2008

Monthly average temperature in Perlis for the year of 2008 is shown in Figure 8. The lowest minimum temperature was 23.27 °C on July. The highest maximum temperature was 33.60 °C on February. The highest temperature difference was 10.19 °C on February.



**Figure 8** Monthly average temperature in Perlis for the year of 2008

Monthly average estimated solar radiation in Perlis for the year of 2008 is shown in Figure 9. The minimum and maximum estimated solar radiation were 13.28 MJ/m<sup>2</sup> on December and 18.29 MJ/m<sup>2</sup> on April, respectively.



**Figure 9** Monthly average solar radiation in Perlis for the year of 2008

## 4 Conclusion

According to result can be concluded that the Hargreaves model can be used to estimate solar radiation for the year of 2008. The comparison of measured and estimated solar radiation from the daily measured temperature shown that the value of CRM is 0.09, it indicates the tendency of the estimation model to under-estimate the measured solar radiation. The value of RMSE is 20.18 %. The value of NSE is 0.03, it is steel far to close to 1. The value of e is 4.08 %, it indicates that the model estimation is acceptable. The minimum, maximum and average daily estimated solar radiation throughout the year of 2008 was 5.06 MJ/m<sup>2</sup> on 24 November, 20.20 MJ/m<sup>2</sup> on 22 February and 16.25 MJ/m<sup>2</sup>, respectively. The monthly minimum and maximum estimated solar radiation were 13.28 MJ/m<sup>2</sup> on December and 18.29 MJ/m<sup>2</sup> on April, respectively. The total estimated solar radiation in a year was 5.95 GJ/m<sup>2</sup>.

## 5 References

- [1] Wu, G., Lin, Y., Wang, T. (2007). Method and Strategy for Modeling Daily Global Solar Radiation with Measured Meteorological Data- A Case Study in Nanchang Station, China. *Energy Conversion & Management, Science Direct*, pp.2447 – 2452.
- [2] Almorox, J., Hontoria., C. (2003). Global Solar Radiation Estimation Using Sunshine Duration in Spain ", *Energy Conversion & Management, ELSEVIER*, 2003, pp.1529 - 1535.
- [3] Markvart, T. (1994). *Solar Electricity*. John Wiley & Sons, LTD., New York, pp.5-19.
- [4] Itagaki, A., Okamura, H., Yamada, M. (2003). Preparation of Meteorological Data Set Throughout Japan For Suitable Design of PV Systems", *3<sup>rd</sup> World Conference on Photovoltaic Energy Conversion*. Japan., pp. 2074 – 2077.
- [5] Mellit, A. , Kalogirou, S.A., Shaari, S., Salhi, H., Arab, A.H. (2007).Methodology for Predictiong Sequences of Mean Monthly Clearness Index and Daily Solar radiation Data in Remote Areas: Application for Sizing a Stand-alone PV System", *Renewable Energy, Science Direct*. pp. 1570 – 1590.



- [6] Muneer, T., Younes, S. , Munawwar, S.(2007) “ Discourses on Solar Radiation Modeling”, *Renew Sustain Energy Rev* 2007, pp. 551-602.
- [7] Yorukoglu, M., Celik, A.N. (2006).A Critical Review on The Estimation of Daily Global Solar Radiation From Sunshine Duration”, *Energy Conversion & Management*. pp. 2441-2450.
- [8] Chineke, T.C. (2007). Equation for Estimating Global Solar Radiation in Data Sparse Regions”, *Renewable Energy*, ScienceDirect, pp. 827 – 831.
- [9] Bandyopadhyay, A. , Bhadra, A., Raghuwanshi, N.S., Singh, R. (2008). Estimation of Monthly Solar Radiation From Measured Air Temperature Extreme. *Agricultural and Forest Meteorology*, ScienceDirect, pp. 1707 – 1718.
- [10]Gavalian, P. , Lorite, I.J. , Tornero, S., Berengena, J. (2005). Regional Calibration of Hargreaves Equation for Estimating Reference ET in a Semiarid Environment. *Agricultural Water Management*, Science Direct, pp. 257-281.
- [11]Menges, H. O., Ertekin, C., Sonmete, M.H. (2006). Evaluation of Global Solar Radiation Models for Konya, Turkey ”, *Energy Conversion & Management*, ScienceDirect, pp. 3149-3173.
- [12]Chen, R., Kang, E., Lu, S. (2006). New Methods to Estimate Global Radiation based on Meteorological Data in China”, *Energy Conversion & Management*, ScienceDirect, pp. 2991-2998.
- [13]Chen, R., Ersi, K., Yang, J., Lu, S., Zhao, W. (2003). Validation of Five Global Radiation Models with Measured Daily Data in China. *Energy Conversion & Management*, Science Direct, pp. 1759-1769.
- [14] Supit, I., Kappel, R V. (1998). A Simple Method to Estimate Global Radiation” *Solar Energy*, Pergamon, pp. 147-159.
- [15]Prieto, J.I., Garcia, J.C. M., Garcia, D. (2009). Correlation Between Global Solar Irradiation and Air Temperature in Asturias, Spain, *Solar Energy*, Science Direct, 1076-1085.

# Comparing various search engines on their ability to find literal meaning and proposing a model for deriving benefits of ontology based search for words in the Qur'an

<sup>1</sup>Md. Sadekur Rahman & <sup>2</sup>Yousuf M. Islam

<sup>1</sup>Daffodil International University, sadekur.cse@daffodilvarsity.edu.bd, +8801676379698

<sup>2</sup>Daffodil International University, ymislam@daffodilvarsity.edu.bd, +8801711876909

## Abstract

A search engine allows one to search for information or desired services. Conceptually, search engines either match the keyword or phrases entered or may do a subject based search. Keyword based search engines generally apply various methods to match a particular word or a phrase and may display web links that are popular and tagged with the keywords using crawling and indexing systems. On the other hand, subject or ontology based search engines use the literal meaning of the keyword to find websites that deal with the subject. Ontology based searches may be useful while looking for related content in a book. For example, using a keyword based search for the word "grapefruit" may display web links that show the properties of grapefruits, origins, benefits, how grapefruits grow, etc. However, searching through a book on food, which discusses citrus fruits in general may or may not list grapefruit. The keyword search may result in zero finds whereas an ontology search may show the areas that discuss citrus fruit. An ontology based search may be useful while looking up keywords in the Qur'an. This paper looks at the various types of search engines that are available for the Qur'an and discusses the benefits that may be derived using ontology based searches using a model.

**Keywords:** *keyword based search, ontology based search, quranic search engine, search engine*

## 1 Introduction

Now-a-day's people spend a lot of time in the virtual world of the Internet. They maintain their business and social activities in web and whenever they face any problem they look into the web for its solution in most of the cases before they seek any help from any expert from that domain. In education also, both to student and teacher, internet is the main source of information while most often it is difficult, time consuming and expensive to collect hard copy of a book. A major use is made of search engines as people may search their relevant topic and get the necessary information within a short span of time. This signifies how important it is for us to use search engines in all activities on the net. But what happens if we face difficulties to find the appropriate output/search result from the search engine?

Before talking about difficulties we should explore how a search engine works actually. Conceptually, search engines either match the keyword or phrases entered or may do a subject based search. Keyword based search engines generally apply various methods to match a particular word or a phrase and may display web links that are popular and tagged with the keywords using crawling and indexing systems.

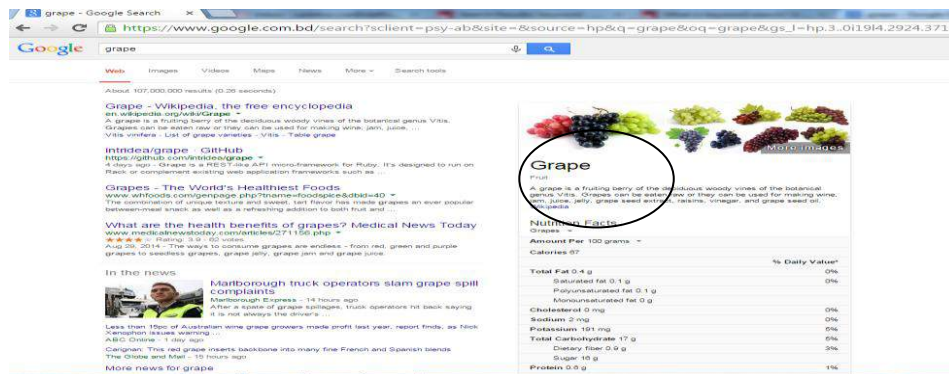
## 2 Detail examples of keyword searches.

Keyword search is the most usual form of searching in web. Almost all the search engines do a text query which is simply a word or phrase matching and show them in an indexed list.

Now the questions, "What is a keyword and what is a keyword search? According wepopedia.com (2015) a keyword is an index entry that identifies a specific record or document or a word used by a

search engine in its search for relevant web pages. And keyword search means the type of search that looks for matching documents that contain one or more words specified by the user.

To cite an example of a keyword search we may consider any word and search it in any search engine. Let us consider the word “grape” and search it in Google which is considered the most popular search engine at world at present. The search result in Google is shown below:



What did the search engine do? It actually matched the word “grape” in a website from billions of websites hosted in the World Wide Web. Sometimes a website assigns preferred keywords in the website. These are known as Meta tags which the search engine uses to identify the website. In this way, search engine tries to index the web pages using Meta tags.

However, a search engine being a program follows conditions that are set for search matching. By itself, a search engine is not capable of using any intelligence to understand the meaning of a word and to execute a search based on the literal meaning. The following figure may help to understand the existing keyword based search technology.

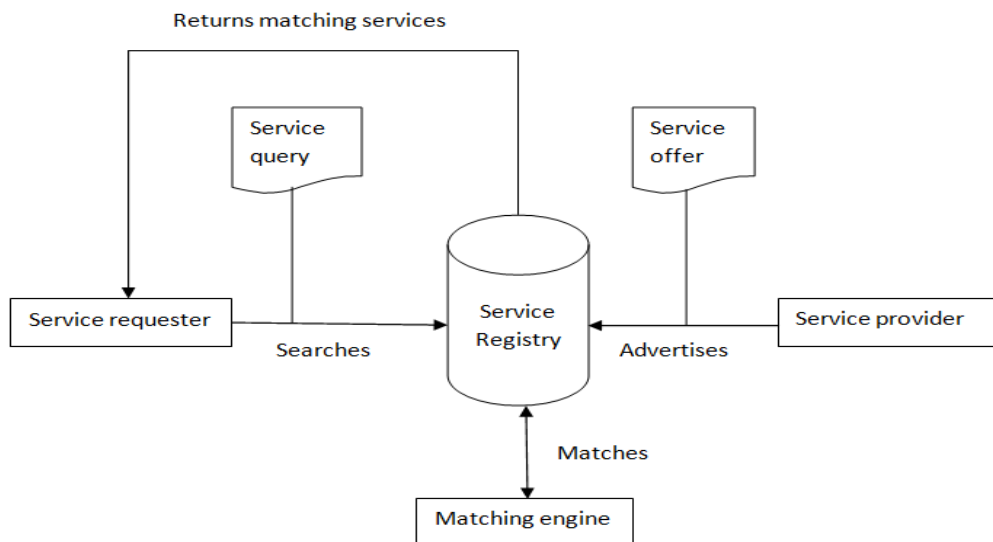


Figure 1. Existing keyword based search matching system

So the Matching engine as shown in Figure 1, matches the words available from the Service Provider with those given by the Service requester and gives a huge list of web links with matching words. Now, if we use the word “grapes” to do the same keyword search in a book like the Holy Qur’an, we would not come up with any verses that contain the specific word “grapes”. However, if the search engine first looked up the type of word that “grape” is, it may be helpful. For example, if the search engine identified that “grape” is a type of fruit and looked up all types of fruits mentioned in the Qur’an, in addition, if it identified the nature of fruit, e.g., citrus fruit and found everything mentioned in the

Qur'an about such fruits, it may helpful. The search could come up with the benefits of similar fruits, the nature of plants that these fruits grow on, use as medicines, *etc.* Such a search would be based on first looking up the meaning of the word and then matching the meaning. Such a methodology would be classified as "Ontology" based search or contextual search.

Direct matching of keywords, as Linda (2004) mentions in her website, that keyword searches have a tough time distinguishing between words that are spelled the same way, but mean something different (i.e. hard cider, a hard stone, a hard exam, and the hard drive on your computer). This often results in hits that are completely irrelevant to the given query. Some search engines also have trouble with so-called stemming, *i.e.*, if the word "big" is entered, should it return a hit on the word, "bigger?" What about singular and plural words? What about verb tenses that differ from the word you entered by only an "s," or an "ed"?

Parul and Sharma (2010) mentioned two types of limitation of existing keyword based search. They are related with word polysemy (means a word has multiple meaning) and synonyms (means the multiple word have same meaning). So, according to them the significance of term for building the index would be reduced and they emphasize the benefits of context based searching.

Subject or ontology based search engines use the literal meaning of the keyword to find websites that deal with the subject. Ontology based searches may be useful while looking for related content in a book. For example, using a keyword based search for the word "*grapefruit*" may display web links that show the properties of grapefruits, origins, benefits, how grapefruits grow, *etc.* However, searching through a book on food, which discusses citrus fruits in general may or may not list grapefruit. The keyword search may result in zero finds whereas an ontology search may show the areas that discuss citrus fruit.

### 3 How does this method work?

Linda (2004) mentions that there are various methods of word clustering, some of which are highly complex, relying on sophisticated linguistics and artificial intelligence. Some numerical approaches and software may used to determine meaning by calculating the frequency with which certain important words appear. When several words or phrases that are tagged to signal a particular concept appear close to each other in a text, the search engine concludes, by statistical analysis that the piece is "about" a certain subject.

For example, the word heart, when used in the medical/health context, would be likely to appear with such words as coronary, artery, lung, stroke, cholesterol, pump, blood, attack, and arteriosclerosis. If the word heart appears in a document with others words such as flowers, candy, love, passion, and valentine, a very different context is established, and a concept-oriented search engine returns hits on the subject of romance.

Molly and Deepa (2012) proposed a framework that may help to develop such a system. The framework is shown in the following figure:

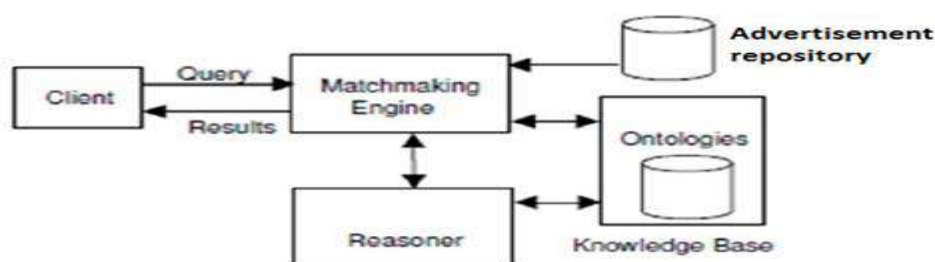


Figure 2: Framework for an ontology based search engine

#### 4 An ontology based search may be useful while looking up keywords in the Qur'an.

It is said that the Holy Qur'an is the complete guidance for mankind. But given the volume, it is time consuming to going through all its verses to find what one is looking for and even though they go through, it may be hard to understand conceptual meaning the Creator has wanted us to understand. Undoubtedly, without deriving the intended benefit it would be a great loss for anyone if it happens.

For the purposes of this paper, we propose an ontology search based on the first Chapter of the Qur'an, *i.e.*, Sura Fatiha. While Sura Fatiha forms the primary part of any "rakat" of prayer offered by Muslims, we derive our idea from the following Verse of the Qur'an:

"And We have bestowed upon you the Seven Oft-Repeated (verses) and the Grand Qur'an."  
[15.87]

It is accepted that Sura Fatiha sums up the entire teaching of the Qur'an. So for the ontology based search, we propose to use Sura Fatiha for the "Reasoner" shown Figure 2. To show this would work, let us first look at the conceptual meaning of the 7 verses of Sura Fatiha using keywords and phrases.

Verse No 1: Beginning – how everything began and how anything begins, *i.e.*, origins

Verse No 2: Credit – credit for conceptualizing, designing and creating the current world and the next world

Verse No 3: Mercy – full of mercy and benevolence

Verse No 4: Judgment – the Judge on the Day of Judgment

Verse No 5: Help – only one source for help, support and guidance

Verse No 6: Guide – He guides

Verse No 7: Correct path – Not the wrong path taken

Based on the meaning of the seven Verses, we propose an ontology based search for the Qur'an. Figure 3 shows how it would work.

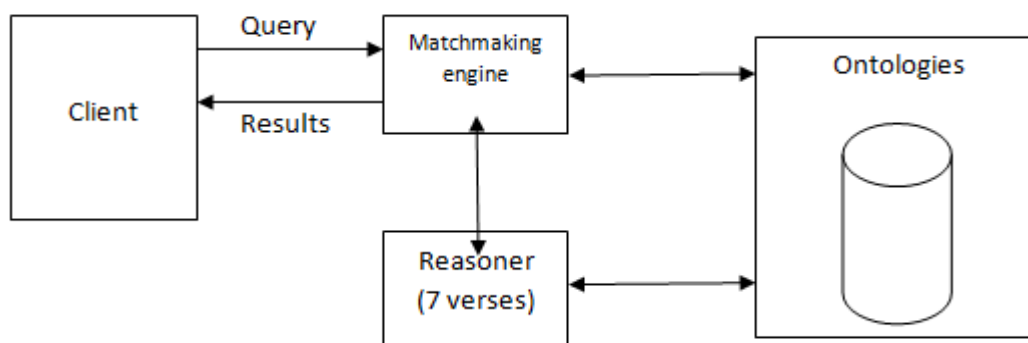


Figure 3. Proposed framework for ontology based search engine for the Qur'an

#### 4.1 An example search:

Let's say we want to search the word "problem". This would be given to the Matching Engine which will access the "Reasoner". The Reasoner will look for matches in the seven verses. It will match Verses 5 and 6. Given these two meanings, the Matching Engine will then find all the Verses that deal with Help and Guidance. It may then display the following Verses:

"O you who believe! Seek *help* with patient perseverance and prayer: for Allah is with those who patiently persevere." [2.153]

"Nay, seek (Allah's) *help* with patient perseverance and prayer: it is indeed hard except to those who bring a lowly spirit." [2.45]

The user can then click on the displayed Verses to look up the context and stories related with the Verses. The user can also opt to further use the next Verse to look up Guidance. We may compare

these results with a simple keyword search of “problem”. This keyword does not yield matching words given in the English translation of Yusuf Ali.

## **5 Conclusion**

Such a meaning based search may prove to be more useful, as the purpose of the Qur’an is for people to understand and utilize underlying meaning in their day to day life and get help from Allah’s Revelation.

## **Reference**

- Gupta, P. and Sharma, A. K. (2010). Context based indexing in search engines using ontology. International Journal of Computer Applications (0975-8887), vol-1 No-14, Retrieved April 6, 2015 from <http://www.ijcaonline.org/journal/number14/pxc387468.pdf>
- Molly, J. R. and Deepa, M. L. (2012). Ontology-based semantic search engine for healthcare services. International Journal of Computer Science and Engineering. Vol-4, No – 4, April 2012, Retrieved April 6, 2015 from <http://www.enggjournals.com/ijcse/doc/IJCSE12-04-04-105.pdf>
- Linda, B. (2004). The Spider’s Apprentice. <http://www.monash.com/spidap4.html> , Last visited April 10, 2015.
- QuinStreet Inc. (2015). [www.webopedia.com](http://www.webopedia.com), last visited on April 10, 2015

## Potential of Solar Radiation to Generate Sine Wave Single Phase Transformerless Photovoltaic Inverter

<sup>1</sup>H. Alam, <sup>2</sup>M.Y. Mashor, <sup>3</sup>M. Irwanto, <sup>4</sup>M. Masri, <sup>5</sup>N. Gomesh, <sup>6</sup>Y.M. Irwan & <sup>7</sup>T. Saragih

<sup>1,3,4,5,6</sup> Centre of Excellence for Renewable Energy (CERE) Department, School of Electrical System Engineering, Universiti Malaysia Perlis (UniMAP), Perlis, Malaysia, hermans\_itm@yahoo.co.id, irwanto@unimap.edu.my, masrimahrizal@yahoo.com, gomesh@unimap.edu.my, irwanyusoff@unimap.edu.my

<sup>2</sup> School of Mechatronic Engineering, Universiti Malaysia Perlis (UniMAP), Perlis, Malaysia, yusoff@unimap.edu.my, +60134883867

<sup>1,3,4,7</sup> Department of Electrical Engineering, Medan Institute of Technology, Medan, Indonesia

### Abstract.

This paper presents a simulation of solar radiation potential to generate sine wave single phase transformerless photovoltaic inverter (TPVI). It is operated directly by photovoltaic (PV) array depended on the solar radiation and temperature. There is requirement of solar radiation value should be fulfilled to run the TPVI in one area, hence before its application an information data of solar radiation is important. This paper simulates the values of solar radiation in Medan, Indonesia based on the mathematical modeling. The result shows that Medan that has latitude of  $3.58^{\circ}$  N, it has average solar radiation of  $1161\text{W}/\text{m}^2$ . It indicates that in Medan, Indonesia is suitable to be installed the sine wave single phase TPVI.

**Keywords:** *solar radiation; temperature; latitude; photovoltaic; transformerless photovoltaic inverter.*

### 1 Introduction

The information data of solar radiation is very important to be applied in the photovoltaic (PV) power generation. The daily, monthly and annual solar radiation should be evaluated to obtain its potential in the PV application. Laleman [1] stated that solar radiation can be classified into four categorizes. They are low solar radiation (below  $2.6\text{ kWh}/\text{m}^2$ ), moderate solar radiation (between  $2.6 - 3\text{ kWh}/\text{m}^2$ ), high solar radiation (between  $3-4\text{ kWh}/\text{m}^2$ ) and very high solar radiation (above  $4\text{ kWh}/\text{m}^2$ ). It is important to know the skies condition and its potential towards PV application in Medan, Indonesia.

The monthly solar radiations are divided by  $1000\text{ W}/\text{m}^2$  to obtain the peak sun hours (PSHs). Weixiang [2] explained that peak sun hours (PSHs) is the length of time in hours at a radiation level of  $1000\text{ W}/\text{m}^2$  needed to produce energy equivalent to the total energy in one day or it is ratio of solar radiation ( $\text{Wh}/\text{m}^2$ ) to solar radiation level of  $1000\text{ W}/\text{m}^2$ .

A transformerless photovoltaic inverter (TPVI) is operated directly by PV array (Irwanto [3], [4], [5]). A PV array voltage of  $220\text{ V}$  is needed to run it. The output power of TPVI depends on the output power of PV array and it also depends on the solar radiation and temperature. Hence, if the TPVI wants to be applied in one area, the information data of solar radiation is needed to be informed that the area is suitable or not to be installed the TPVI. The solar irradiation of  $3\text{ kWh}/\text{m}^2$  or solar irradiance of  $300\text{ W}/\text{m}^2$  are the values are suitable to run the TPVI (Daut [6], [7]).

This paper presents simulation of the potential of solar radiation to generate the TPVI. Based on the mathematical modeling, the daily, monthly, annual solar radiation and PSHs in Medan, Indonesia are evaluated to decide that it is suitable or not to be installed the TPVI.



## 2 Methodology

### 2.1 Latitude of Medan

Medan is the capital of the North Sumatra province in Indonesia. Located on the northern coast, Medan is the fifth largest city in Indonesia behind Jakarta, Surabaya, Bandung, Bekasi and the largest Indonesian city outside Java. Medan has latitude of  $3.58^{\circ}$  N and land area of  $265.1 \text{ km}^2$  as shown in Figure 1.

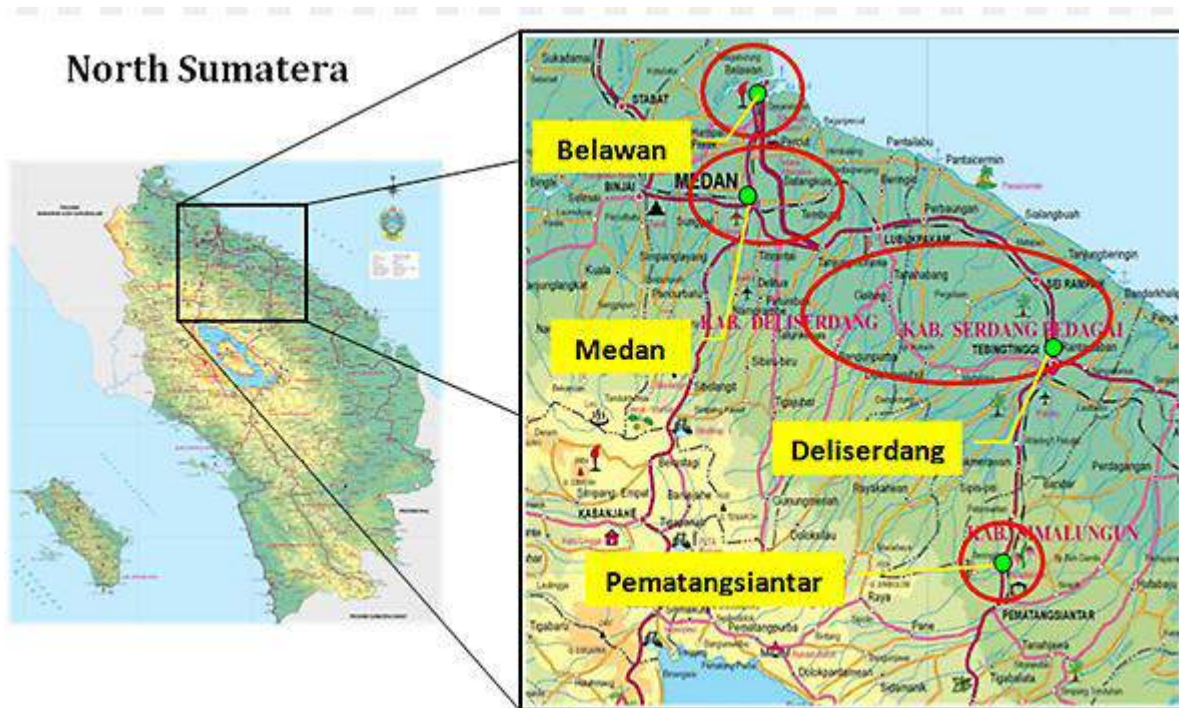


Figure 1 Map of Medan has latitude of (<http://www.give2habitat.org/member/medan/Medan>[8])

### 2.2 Solar Irradiance

The electricity power generated by PV systems is directly related to the solar energy received by the PV module, while the PV module can be placed at any orientations and any tilt angles, but most local observatories only provide solar irradiance data on a horizontal surface. Thus, an estimation of the solar irradiance on a tilt surfaces is calculated by adding the beam, diffuse, and reflected solar irradiance components on the tilt surface together by Pandey [9], as in Figure 2.

The total solar irradiance on tilt surface is given by:

$$I_{tt} = I_{bt} + I_{dt} + I_{rt} \quad (1)$$

where  $I_{tt}$  is the total solar irradiance on the tilt surface,  $W/m^2$ ;  $I_{bt}$  is the total beam solar irradiance absorbed by the tilt surface,  $W/m^2$ ;  $I_{dt}$  is the total diffuse solar irradiance absorbed by the tilt surface,  $W/m^2$ ; and  $I_{rt}$  is the total reflected solar irradiance absorbed by the tilt surface,  $W/m^2$ .



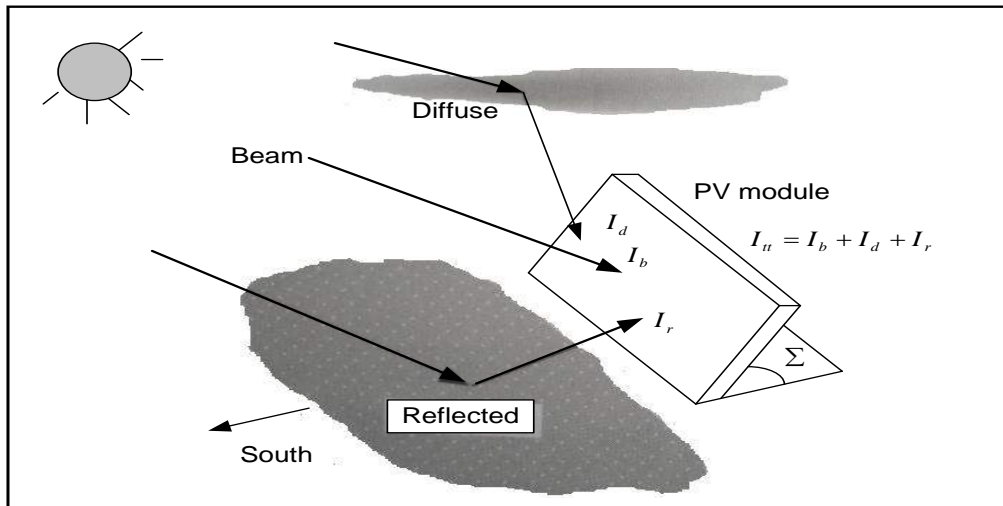


Figure 2 Total solar irradiance of tilt surface of PV module

### 2.2.1 Beam Solar Irradiance

The translation of direct-beam irradiance  $I_b$  (normal to the rays) into beam irradiance striking a PV module face  $I_{bt}$  is a simple function of the angle of incidence  $\theta$  between a line drawn normal to the PV module face and the incoming beam irradiance. It is given by

$$I_{bt} = I_b \cos \theta \quad (2)$$

where  $I_b$  is the beam portion of the radiation reaching the earth's surface (normal to the rays), is given by

$$I_b = Ae^{-kn} \quad (3)$$

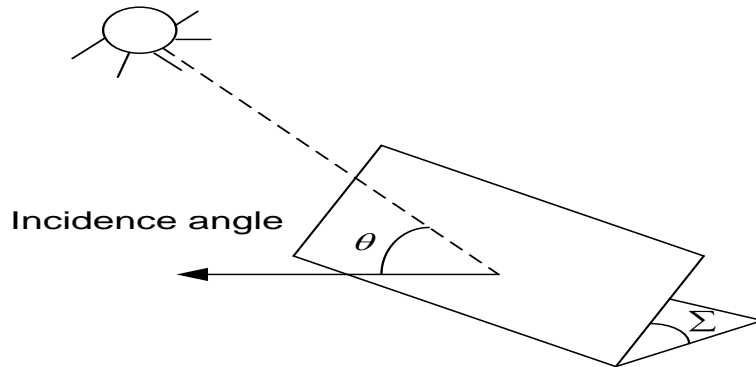
where  $A$  is an "apparent" extraterrestrial flux, and  $k$  is a dimensionless factor called the optical depth, given by

$$A = 1160 + 75 \sin \left[ \frac{360}{365} (n - 275) \right] \quad (4)$$

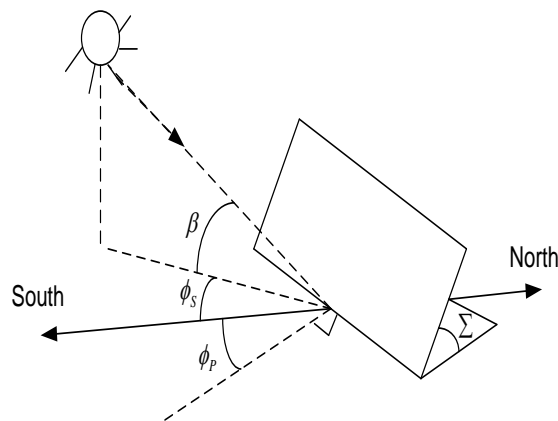
$$k = 0.174 + 0.035 \sin \left[ \frac{360}{365} (n - 100) \right] \quad (5)$$

The air mass ratio  $m$  is given by

$$m = \frac{1}{\sin \beta} \quad (6)$$



**Figure 3** The incidence angle  $\theta$  between a normal to the PV module face and the incoming solar beam irradiance



**Figure 4** Illustrating the PV azimuth angle  $\phi_p$  and tilt angle  $\Sigma$  along with the solar azimuth angle  $\phi_s$  and altitude angle  $\beta$ . Azimuth angles are positive in the southeast direction and are negative in the southwest

The angle of incidence  $\theta$  will be a function of the photovoltaic orientation and the altitude and azimuth angles of the sun at any particular time. Fig. 5 introduces these importance angles. The photovoltaic is tipped up at angle  $\Sigma$  and faces in a direction described by its azimuth angle  $\phi_p$  (measured relative to due south, with positive value in the southeast and negative value in the southwest). The incidence angle is given by

$$\cos \theta = \cos \beta \cos(\phi_s - \phi_p) \sin \Sigma + \sin \beta \cos \Sigma \quad (7)$$

The solar azimuth angle  $\phi_s$  is given by Pandey [9]

$$\sin \phi_s = \frac{\cos \delta \sin H}{\cos \beta} \quad (8)$$

where  $H$  is hour angle ( the number of degrees that the earth must rotate before the sun will be directly over local meridian or line of longitude), is given by Castaner [10]

$$H = \cos^{-1}(-\tan L \tan \delta) \quad (9)$$

### 2.2.2 Diffuse Solar Irradiance

The simplest models of diffuse irradiation assume it arrives at a site with equal intensity from all direction; that is, the sky is considered to be isotropic. Obviously, on hazy or overcast days the sky is considerably brighter in the vicinity of the sun, and measurements show a similar phenomenon on clear days as well, but these complications are often ignored. The following expression for diffuse irradiance on the photovoltaic module

$$I_{dt} = CI_b \left( \frac{1 + \cos \Sigma}{2} \right) \quad (10)$$

where  $C$  is a sky diffuse factor and a convenient approximation is as follows :

$$C = 0.095 + 0.04 \sin \left[ \frac{360}{365} (n - 100) \right] \quad (11)$$

### 2.2.3 Reflected Solar Irradiance

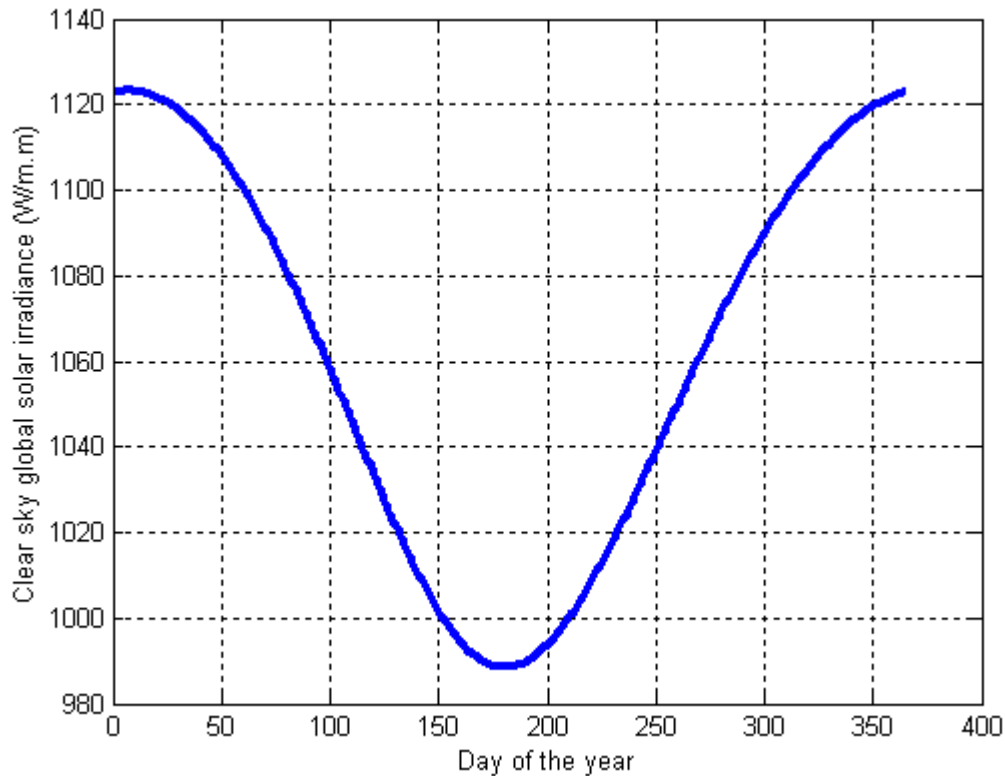
The final component of irradiance striking a photovoltaic module results from radiation that is reflected by surfaces in front of the module. The simplest model assumes a large horizontal area in front of the module, with a reflectance  $\rho$  that is diffuse, and it bounce the reflected irradiance in equal intensity in all direction. The solar reflected irradiance is given by

$$I_{rt} = \rho I_b (\sin \beta + C) \left( \frac{1 - \cos \Sigma}{2} \right) \quad (12)$$

### 3 Results and Discussion

#### 3.1 Daily solar irradiance

The daily solar irradiance through a year is shown in Figure 5.



**Figure 5** Daily solar irradiance through a year

Figure 5 shows that the minimum, maximum and average solar irradiance are  $988.50 \text{ W/m}^2$ ,  $1123.00 \text{ W/m}^2$  and  $1061 \text{ W/m}^2$  which are above  $300 \text{ W/m}^2$  (as requirement of TPVI application). It indicates that the sky in Medan is clear and very high for a year and gives big potential for the application of sine wave single phase TPVI.

#### 3.2 Monthly solar irradiance

The Monthly beam, diffuse, reflected and global solar irradiance in Medan, Indonesia are shown in Figure 6. Figure 7 shows the monthly minimum, maximum and average solar irradiance of PV module.

Based on solar irradiance of a year, Medan has a big solar irradiance potential, its average is  $1161 \text{ W/m}^2$ . The monthly highest average solar irradiance is  $1122 \text{ W/m}^2$  on January and its lowest is  $992.52 \text{ W/m}^2$  on July. These data show that the solar irradiance can be used for certain application, especially in application of sine wave single phase TPVI.

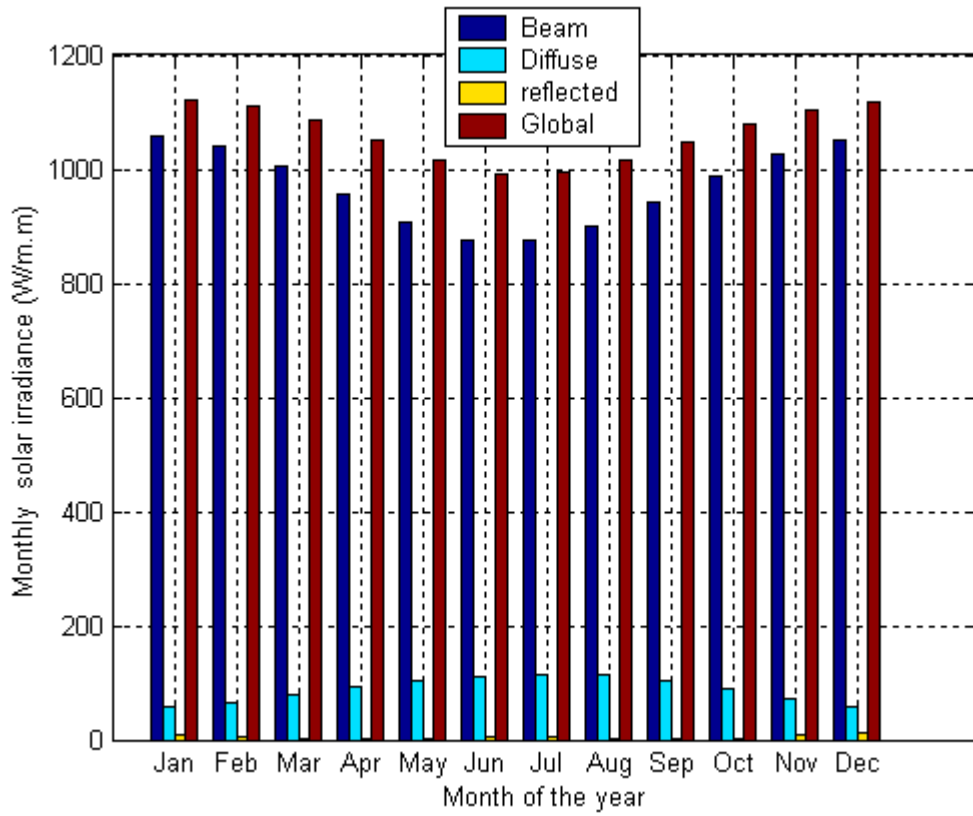


Figure 6 Monthly beam, diffuse, reflected and global solar irradiance

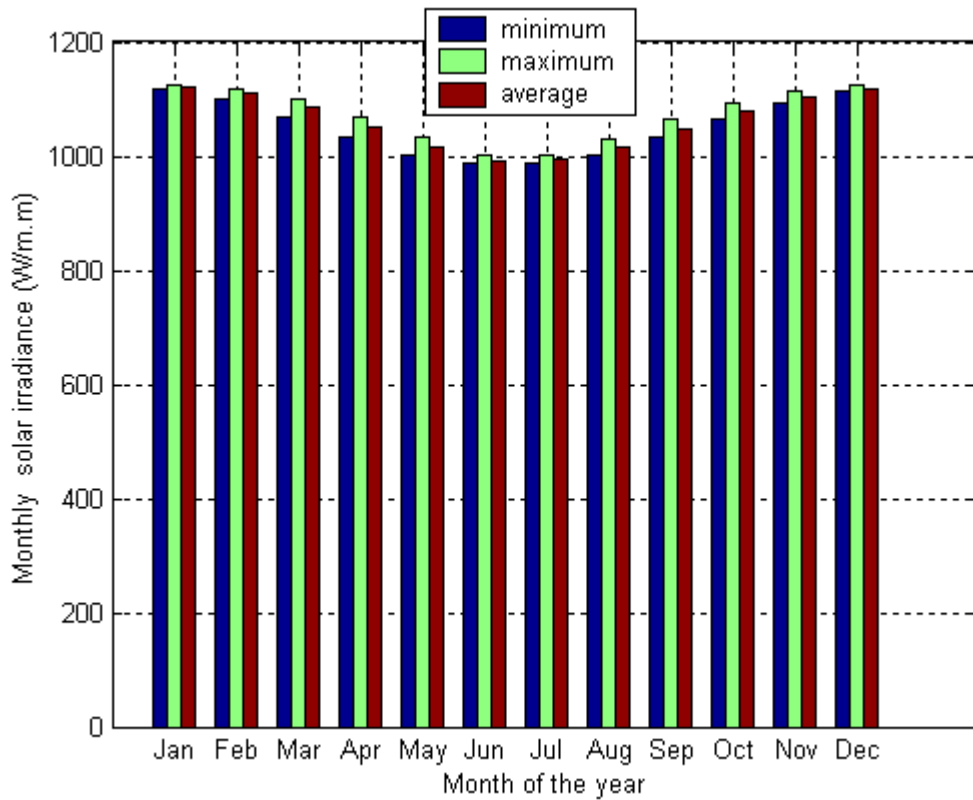


Figure 7 Monthly minimum, maximum and average solar irradiance

## 4 Conclusion

The information data of solar radiation is needed to be informed that the area is suitable or not to be installed the TPVI.

A transformerless photovoltaic inverter (TPVI) is operated directly by PV array depended on the solar radiation and temperature. The solar irradiation of 3 kWh/m<sup>2</sup> or solar irradiance of 300 W/m<sup>2</sup> are the values are suitable to run the TPVI

Based on solar irradiance of a year, Medan has a big solar irradiance potential, its average is 1161W/m<sup>2</sup>. It indicates that the solar irradiance can be used for certain application, especially in application of sine wave single phase TPVI.

## 5 References

- [1] Laleman, R., Albrech, J., & Dewulf, J. (2011). Life Cycle Analysis to Estimate the Environment impact of Residential Photovoltaic Systems in Region with Low Solar Radiation. *Renewable and Sustainable Energy Review*, 15, 267 – 281.
- [2] Weixiang, S., Bin, A.S.K., & Seng, O.K (2005). A study on Standalone Photovoltaic System with Real Meteorological Data at Malaysia. *IEEE Xplore*, 937 – 941.
- [3] Irwanto, M., Daut, I., Nizar.,T.M., Irwan, Y.M., Rosnazri,A., Gomesh, N., Suwarno. (2011). Single Phase Transformerless Photovoltaic Inverter. *Proceeding of International Postgraduate Conference on Engineering (IPCE2011)*, UniMAP, Perelis, Malaysia, 22-23 October 2011.
- [4] Irwanto, M., Gomesh, N., Irwan, Y.M., Fitra, M. (2013). Power Capacity Enhancement of Transformerless Photovoltaic Inverter. *Proceeding of 2013 IEEE 7<sup>th</sup> International Power Engineering and Optimization Conference (PEOCO2013)*, Langkawi, Malaysia, 3-4 June 2013. IEEE Xplore Publication/ Indexed by SCOPUS.
- [5] Irwanto, M. (2014). Effect of Maximum Voltage Angle on Three-Level Single Phase Transformerless Photovoltaic Inverter Performance. *International Journal of Engineering and Applied Sciences*, Vol. 5. No. 05.
- [6] Daut,I., Irwanto, M., Irwan, Y.M., Gomesh, N., Ahmad, N.S. (2011). Combination of Hargreaves Method and linear Regression as a New Method to Estimate Solar radiation in Perlis, Northern Malaysia. *Journal of Solar Energy*, Volume 85, Issue 11, November 2011, Pages 2871-2880.
- [7] Daut,I., Irwanto, M., Irwan, Y.M., Gomesh, N., Ahmad, N. S. (2011). Clear Sky Global Solar Irradiance on Tilt Angles of Photovoltaic Module in Perlis, Northern Malaysia. *Proceeding of International Conference on Electrical, Control and Computer Engineering*, Pahang, Malaysia, June 21-22, 2011. IEEE Xplore Publication.
- [8] <http://www.give2habitat.org/member/medan/Medan>
- [9] Pandey, C.K. A note on diffuse solar radiation on a tilted surface. *Energy*, 34 ,1764–1769.
- [10] Castaner, L., Silvestre, S.. *Modelling Photovoltaic Systems Using PSpice*. , John Wiley & Sons, LTD.

# Comparative Study of Measured and Simulated Photovoltaic Performance Based on Statistical Analysis

<sup>1</sup> M. Masri, <sup>2</sup> R. Badlisha, <sup>3</sup> M. Irwanto, <sup>4</sup> H. Alam, <sup>5</sup> N. Gomesh, <sup>6</sup> Y.M. Irwan & <sup>7</sup> Suwarno

<sup>1,3,4,5,6,7</sup> Centre of Excellence for Renewable Energy (CERE) Department, School of Electrical System Engineering, Universiti Malaysia Perlis (UniMAP), Perlis, Malaysia, masrimahrizal@yahoo.com, badli@unimap.edu.my, irwanto@unimap.edu.my, hermans\_itm@yahoo.co.id, gomesh@unimap.edu.my, irwanyusoff@unimap.edu.my, arnomed@yahoo.com

<sup>2</sup> School of Computer and Communication Engineering, Universiti Malaysia Perlis (UniMAP), Perlis, Malaysia, yusoff@unimap.edu.my, +60134883867

<sup>1,3,4,7</sup> Department of Electrical Engineering, Medan Institute of Technology, Medan, Indonesia

## Abstract.

This paper presents a simulation and measurement of A 21 V, 62 W UNI SOLR photovoltaic (PV) module performance. A mathematical modeling is used to simulate the PV module performance using Matlab software. The measurement of PV module performance is done out side of Renewable Energy Excellence Centre (REEC) building, School of Electrical System Engineering, Universiti Malaysia Perlis (UniMAP). The PV module performance is measured using PROVA Solar Module Analyzer. Solar irradiance and temperature around the PV module are measured using solar meter and infra red temperature, respectively. The statistical analysis is conducted in term of root mean squared error (*RMSE*), coefficient of residual mass (*CRM*), percentage error (*e*) and Nash-Sutcliffe equation (*NSE*) to validate the measured and simulated PV module performance. The result shows that if the solar radiation increases, thus the short circuit current, maximum power and efficiency will increase also. The statistical analysis can be used to validate the measured and simulated PV module performance.

**Keywords:** solar irradiance; temperature; photovoltaic; I-V curve; statistical analysis.

## 1 Introduction

Cook [1] stated that the major factors which influence the electrical design of the PV module are solar irradiance, tilt angle of PV module, load matching for maximum power and operating temperature. The performance of the PV module is generally represented by the current versus voltage (I-V curve). The performance of a PV module are influenced by temperature and solar irradiance, and they influence on the design of PV module system (El-Zayyat [2])

Wu [3] explained that the temperature is an important consideration in the operation of PV module system. At lower temperatures, PV module systems produce more power. For higher temperature, optimum operation requires modification of electrical load and removal of excess heat. At high temperatures, two predominating effects can cause efficiency to drop. As thermal energy increases, (1) lattice vibrations interface with the free passing of charge carries and (2) the junction begins to loss its power to separate charges. The efficiency losses for PV systems can be minimized in the presence of temperature variations. In most cases, good solutions are a temperature-dependent charge controller or a maximum power tracker. Both device improve the overall system efficiency at higher temperature where the performance is poor.

This paper presents a modelling mathematic to simulate a PV module performance. A 21 V, 62 W UNI SOLAR PV module was tested with constant solar irradiance and varied temperature, also with

constant temperature and varied solar irradiance, both the PV module performance observed using Matlab software. The observed PV module performance are the short circuit current, the open circuit voltage, the maximum power, the fill factor and the efficiency.

## 2 Methodology

### 2.1 Data sheet of PV module

A 21 V, 62 W UNI SOLAR PV module was used in this study. Table 3.1 shows the complete data sheet of the PV module.

**Table 1** Electricity parameters of 21 V, 62 W UNI SOLAR PV module

Electrical Parameters	Value
Maximum power point ( $P_{MPP}$ )	62 W
Module current in the maximum power point and STC conditions ( $I_{MPP}$ )	4.13 A
Short circuit current under test condition ( $I_{sc}$ )	5.1 A
Nominal temperature according to STC ( $T_N$ )	25 °C
Temperature coefficient of the short circuit current ( $TC_i$ )	+0.004028%/K
Temperature coefficient of the open circuit voltage ( $TC_v$ )	-0.104V/K
Open voltage at 25 °C and low solar irradiation ( $V_{min}$ )	15 V
Open voltage at 25 °C and high solar irradiation ( $V_{max}$ )	21 V
Open voltage of an unload module ( $V_{oc}$ )	21 V
Low solar irradiation ( $\alpha_{min}$ )	200 W/m <sup>2</sup>
High solar irradiation ( $\alpha_{max}$ )	1000 W/m <sup>2</sup>

### 2.2 Measurement of the PV Module Performance

The measurement of PV module performance is done out side of Renewable Energy Excellence Centre (REEC) building as represented in Figure 1. The measurement condition of temperature and solar irradiation are 727 W/m<sup>2</sup> and temperature of 35 °C, respectively. They are measured using solar power meter and infra red temperature. The measurement procedure is stated below.

1. Set up the equipment as represented in Fig. 3.6. They consist of 21 V, 62 W UNI SOLAR PV module (it is as object that will be measured its performance), PROVA 200 solar module analyzer (it is as measurer of the curves of power versus voltage and current versus voltage of PV module), solar power meter (it is as measurer of solar irradiation near the PV module) and infra red temperature (it is as measurer of PV module surface temperature).



2. Connect the positive and negative terminal PV module to positive and negative of PROVA 200 solar module analyzer.
3. Measure and record the curves of power versus voltage and current versus voltage of PV module, the solar irradiation near the PV module and the PV module surface temperature.



**Figure 1** Measurement of PV module performance

### 2.3 Simulation of Effect of Temperature and solar irradiation on the Performance of PV Module

The current, voltage, power and efficiency of PV module under the temperature and solar irradiation is simulated using Matlab software. As representative of solar irradiation effect, the simulation is done for three different solar irradiation ( $1000 \text{ W/m}^2$ ,  $800 \text{ W/m}^2$  and  $600 \text{ W/m}^2$ ) and constant temperature ( $25^\circ\text{C}$ ). Also as representative of temperature effect, the simulation is done for three different temperature ( $25^\circ\text{C}$ ,  $45^\circ\text{C}$  and  $65^\circ\text{C}$ ) and constant solar irradiation ( $1000 \text{ W/m}^2$ ). They stated below.

1. Simulate the effect of temperature and solar irradiation on the performance of PV module, the Matlab is used to simulate their curves of current over voltage and power over voltage for each solar irradiation as mentioned above by using Equation (1) and (2).

The mathematical modelling of open circuit voltage and circuit current of a performance of PV module follows what was suggested by Ulrick [4]. The application of this model requires the data of minimum open voltage,  $V_{\min}$  and maximum open voltage,  $V_{\max}$  in two operation points with low solar irradiation phase,  $\alpha_{\min}$  of  $200 \text{ W/m}^2$  and high solar irradiation phase,  $\alpha_{\max}$  of  $1000 \text{ W/m}^2$  at the same nominal temperature,  $T_N$  of  $25^\circ\text{C}$ .

Beside those four parameters, five parameters from the data sheet of PV module are required to simulate the performance of PV module. They are the short circuit current  $I_{sc}$ , open circuit voltage at maximum peak point,  $V_{MPP}$  and current at the maximum peak point,  $I_{MPP}$ , all at the STC (standard test condition) as well as the coefficient of temperature for the short circuit current,  $TC_i$  and the coefficient of temperature for open circuit voltage,  $TC_v$ . The parameter of "b" is the PV model fixed parameter. It influences the I-V curve in the maximum power point. The circuit current  $I(\alpha, T, V)$  and open circuit voltage  $V_{oc}(\alpha, T)$  as function of solar irradiation, temperature and voltage are given by Ulrick [4]:

$$I(\alpha, T, V) = \frac{\alpha}{1000 \frac{W}{m^2}} \cdot I_{sc} \cdot \tau_i(T) \cdot \left[ \frac{1 - e^{-\left[ \frac{V}{b \cdot \left( 1 + \frac{V_{max} - V_{min}}{V_{max}} \cdot \frac{\alpha - \alpha_{max}}{\alpha_{max} - \alpha_{min}} \right) (V_{max} + \tau_v(T)) \right] \frac{1}{b}}}}{1 - e^{-\frac{1}{b}}} \right] \quad (1)$$

When  $I(\alpha, T, V) = 0$  A, the open circuit voltage is given by

$$V_{oc}(\alpha, T) = \left[ 1 + \frac{V_{max} - V_{min}}{V_{max}} \cdot \frac{\alpha - \alpha_{max}}{\alpha_{max} - \alpha_{min}} \right] \cdot [V_{max} + \tau_v(T)] \quad (2)$$

$$\tau_i(T) = 1 + \frac{TC_i}{100\%} \cdot (T - T_N) \quad (3)$$

$$\tau_v(T) = TC_v \cdot (T - T_N) \quad (4)$$

2. Change the temperature and solar irradiation values for to the same PV module. Using the Matlab, each PV module maximum peak point voltage, short circuit current, maximum peak point current, maximum power and efficiency are found for every changes of temperature and solar irradiation and recorded and created in Matlab m-File. 3-dimensional diagrams of PV module maximum peak point voltage, short circuit current, maximum peak point current, maximum power and efficiency are as function of both temperature and solar irradiation were plotted with listing Matlab program.

## 2.4 Simulation and Measurement Validation of the PV Module Performance

The data of simulated and measured PV module power is used as validation. The measured and simulated power of PV module were used as comparison, the comparison based on the measurement and simulation on the solar irradiation of 727 W/m<sup>2</sup> and temperature of 35 °C. Matlab program is used to perform the validation on the step by step method as stated below.

1. Following the simulation of PV module performance on the section 2.3, the simulation powers of PV module for each resolution time are represented in Matlab common window. They are arranged in a row matrix with dimension 1x 150 which indicate that there are 150 data to be validated.
2. Following the measurement of PV module performance on the section 2.2, the measurement powers of PV module are converted in to excel and arranged using Matlab in a row matrix with dimension 1x 150 which indicate that also, there are 150 data to be validated.

3. The comparison between simulated and measured PV module power is validated by using statistical analysis. The statistical analysis is conducted in term of root mean squared error (*RMSE*), coefficient of residual mass (*CRM*), percentage error (*e*) and Nash-Sutcliffe equation (*NSE*) as explained below which uses Equation (5), (6), (7) and (8), respectively (Almorox [5]).

$$CRM = \frac{\sum_{i=1}^n P_{mea,i} - \sum_{i=1}^n P_{sim,i}}{\sum_{i=1}^n P_{mea,i}} \quad (5)$$

where  $P_{mea,i}$  is the measured power of PV module at *i* data,  $P_{sim,i}$  is the simulated power of PV module at *i* data,  $\overline{P_{mea}}$  is the average measured power of PV module and *n* is the data number of simulated and measured PV module power.

*CRM* presents overall over or under simulation. For perfect simulation, the value of *CRM* should be zero. A *CRM* has negative value, it indicates a tendency to over-estimate the measured and a *CRM* has positive value, it indicates the tendency of the simulation model to under – estimate the measured power of PV module power of PV module.

$$RMSE(\%) = \sqrt{\frac{\sum_{i=1}^n (P_{sim,i} - P_{mea,i})^2}{\frac{n}{P_{mea}}}} \times 100 \quad (6)$$

The *RMSE* is presented as percentage and it has no dimension. A lower *RMSE* presents a better performance.

$$NSE = 1 - \frac{\sum_{i=1}^n (P_{mea,i} - P_{sim,i})^2}{\sum_{i=1}^n (P_{mea,i} - \overline{P_{mea}})^2} \quad (7)$$

*NSE* is also known as determination coefficient ( $R^2$ ), when *NSE* is closer to 1 for all the simulated powers of PV module match perfectly with the measured powers indicates a more efficient model. The simulation model used has a poor performance if *NSE* is close to zero (lower value) and worse performance if *NSE* has negative value.

$$e(\%) = \frac{P_{mea,i} - P_{sim,i}}{P_{mea,i}} \times 100 \quad (8)$$

A relative percentage error is considered acceptable if its value is interval range -10% and +10%. The mean percentage error is defined as the percentage deviation of the simulated and measured power of PV module.

### 3 Results and Discussion

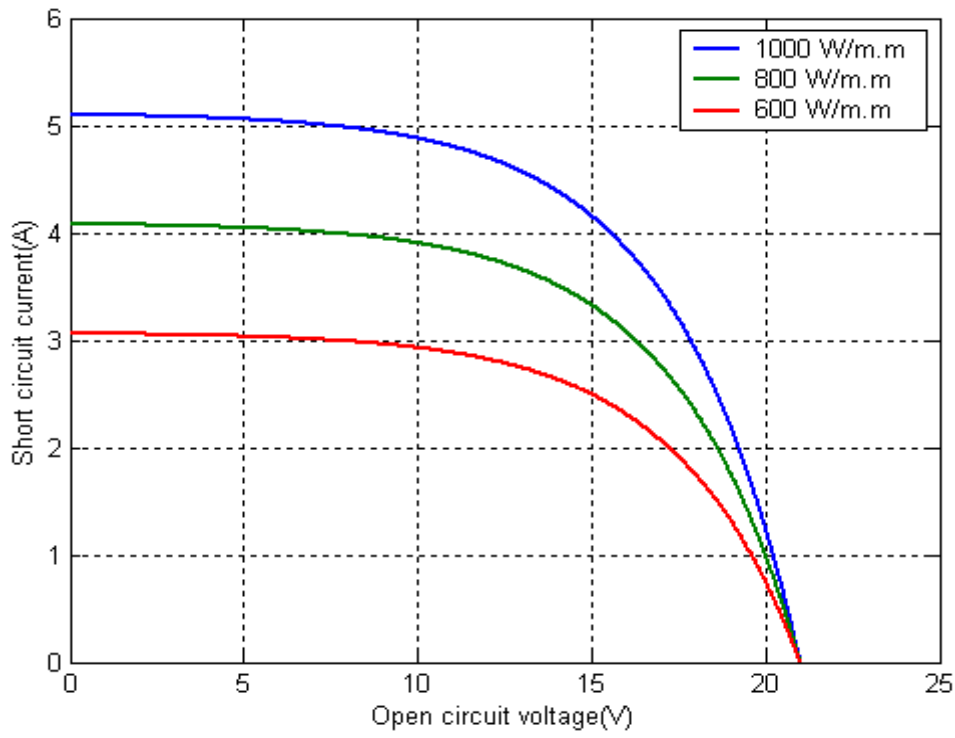
#### 3.1 Simulation of photovoltaic module performance

The performance of PV module is generally represented by the current versus voltage (i-v) curve. It is influenced by temperature and solar irradiation, and it influence on the design of PV module system (El-Zayyat, 1988). If the temperature is increased and solar irradiation is constant, the open circuit voltage and maximum power of PV module will decrease. Inversely, if the solar irradiation is increased and the temperature is constant, the open circuit voltage and maximum power of PV module will increase (Riedel, et. al, 2002; Rosell & Ibanez, 2005; ). 21 V, 62 W UNI SOLAR PV module was measured and simulated using Matlab software to be analyzed its performance. The measurement and simulation result are validated using statistical analysis.

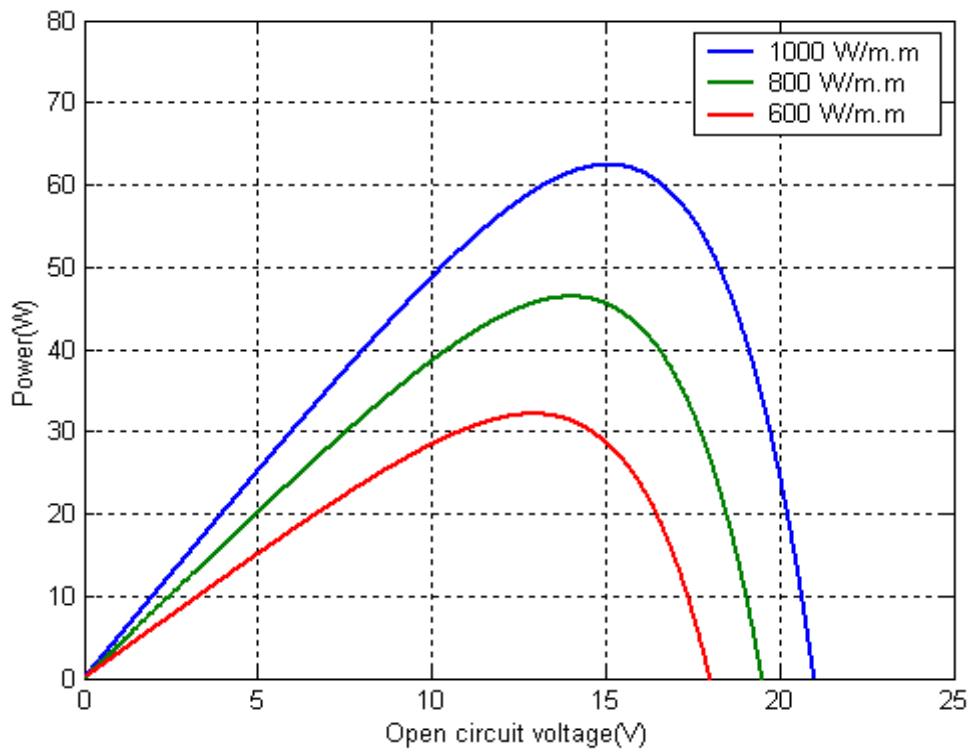
Figure 2 and 3 show the temperature and solar irradiation effect on the PV module performance, respectively. The value of the maximum power, short circuit current and efficiency of each the temperature and solar irradiation can be seen in Table 2.

The solar irradiation effect on the PV module performance was simulated on the constant temperature of 25 °C and different solar radiation (1000 W/m<sup>2</sup>, 800 W/m<sup>2</sup> and 600 W/m<sup>2</sup>). The results show that they are much larger in the short circuit current than the open circuit voltage and gives significant effect on maximum power. Based on Figure 2 and Table 2, if the solar radiation increases, thus the short circuit current, maximum power and efficiency will increase also. It is due to that under constant temperature the value of the open circuit voltage and the short circuit current are logarithmic scales which, in turn with the solar irradiation are linear scales resulting in a logarithmic dependence of the open circuit voltage to the solar irradiation (Ulrick [4]).

The effect of temperature on the performance of PV module was simulated on the constant solar radiation of 1000 W/m<sup>2</sup> and different temperature (25 °C, 45 °C and 65 °C). The results show that under constant solar irradiation and difference temperature, the open circuit voltage and short circuit current of PV module will be influenced significantly and slightly, respectively. The open circuit voltage tends to decrease with increasing temperature (see Figure 3 (b) and Table 2). When temperature increase, the amount of saturation current will increase more than the amount of photocurrent and therefore makes the open circuit voltage decreased rapidly (Wu [3]). The short-circuit current tends to increase with increasing temperature (see Figure 3 (a) and Table 2). When temperature increase, the diffusion coefficient  $D$ , the minority life time  $\tau$ , the diffusion length  $L$  and the intrinsic carrier density will increase. The change of these parameters will enhance diffusion, i.e, a larger  $D$ . The photocurrent generated by the PV module is the sum of electron diffusion current, hole diffusion current and dominant generation current in the depletion region. The generation current in the ideal depletion region is independent of temperature, so the increase of diffusion will result in an increase of photocurrent (Wu [3]).

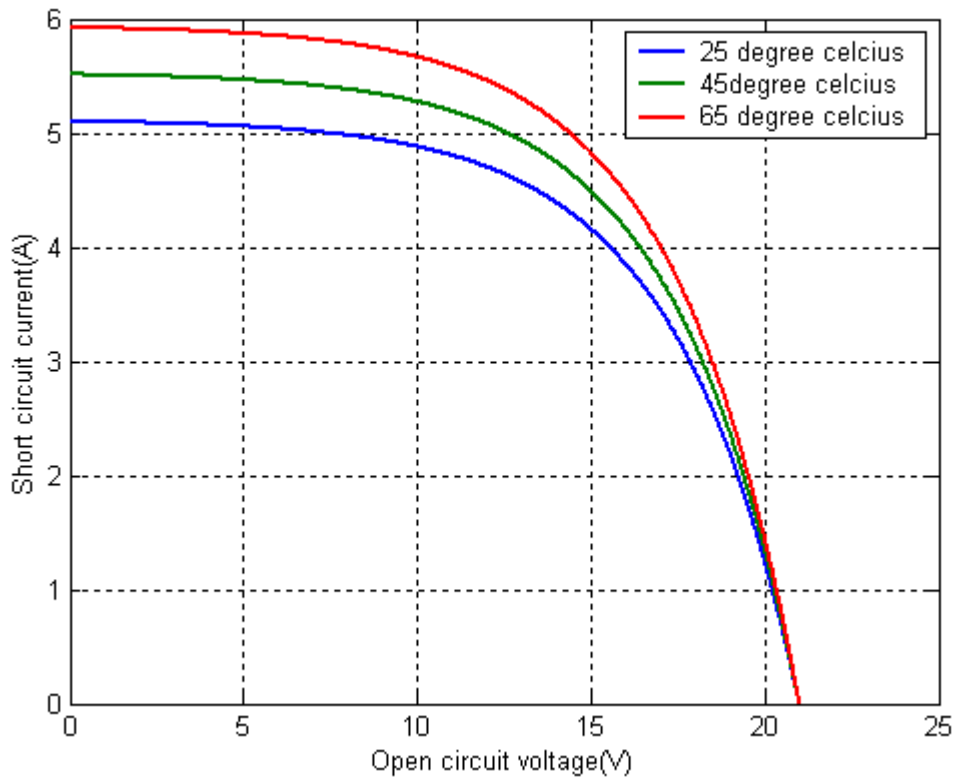


(a): Curve of short circuit current against open circuit voltage

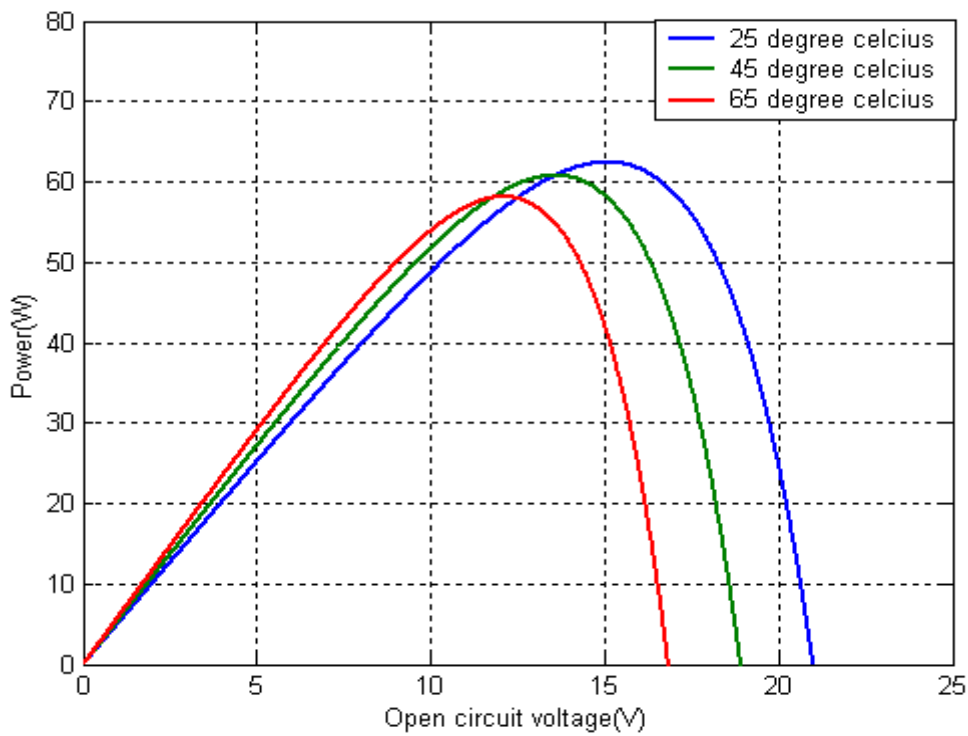


(b): Curve of power against open circuit voltage

**Figure 2** Solar irradiation effect on the PV module performance



(a): Curve of short circuit current against open circuit voltage



(b): Curve of power against open circuit voltage

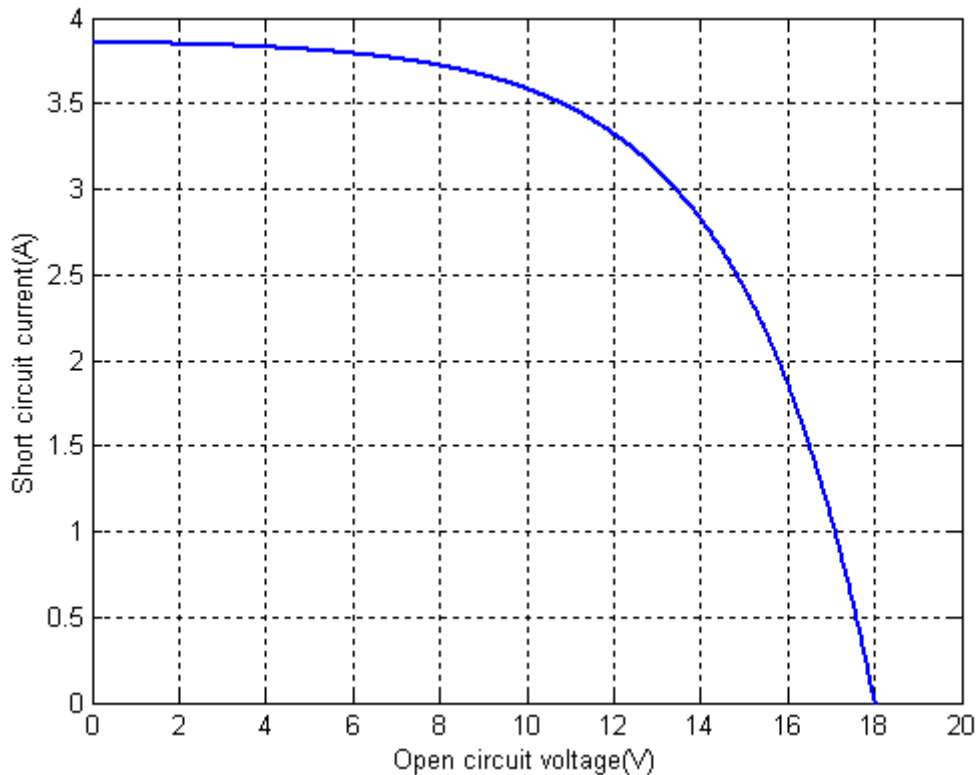
**Figure 3** Temperature effect on the PV module performance

Table 2 PV module performance at different temperature and solar irradiation

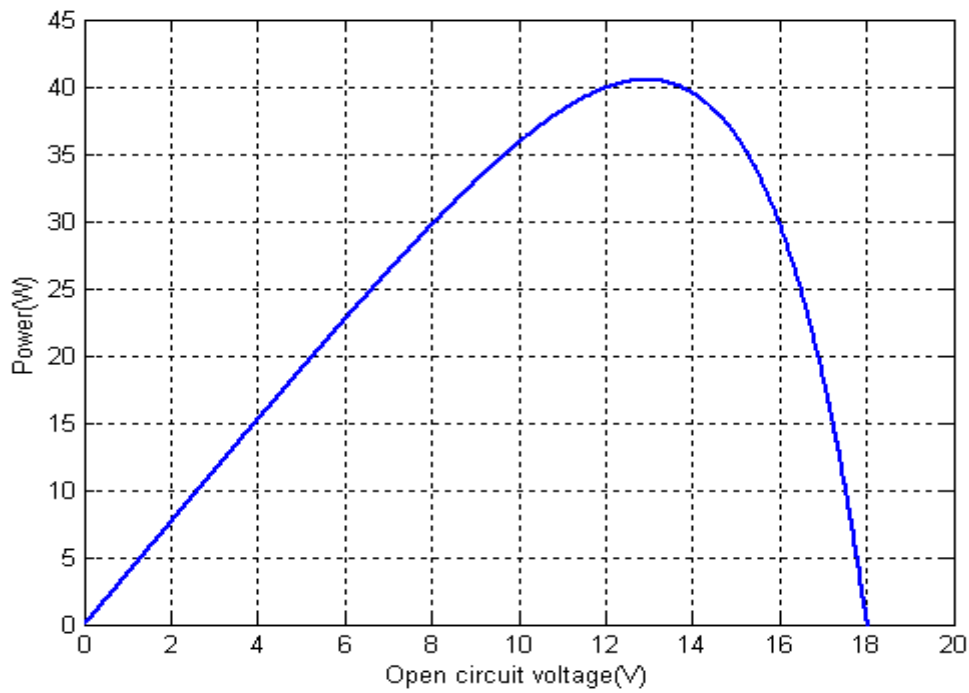
Performance of PV module	Different solar irradiation and constant temperature (25 °C)			Different temperature and constant solar irradiation (1000 W/m <sup>2</sup> )		
	1000 W/m <sup>2</sup>	800 W/m <sup>2</sup>	800 W/m <sup>2</sup>	25 °C	45 °C	65 °C
Short circuit current (A)	5.10	4.08	3.06	5.10	5.51	5.92
Maximum power (W)	62.00	46.38	32.11	62.0	60.78	58.13
Efficiency (%)	100	74.81	51.79	100	98.03	93.76

### 3.2 Measurement and Simulation Validation of PV Module Performance

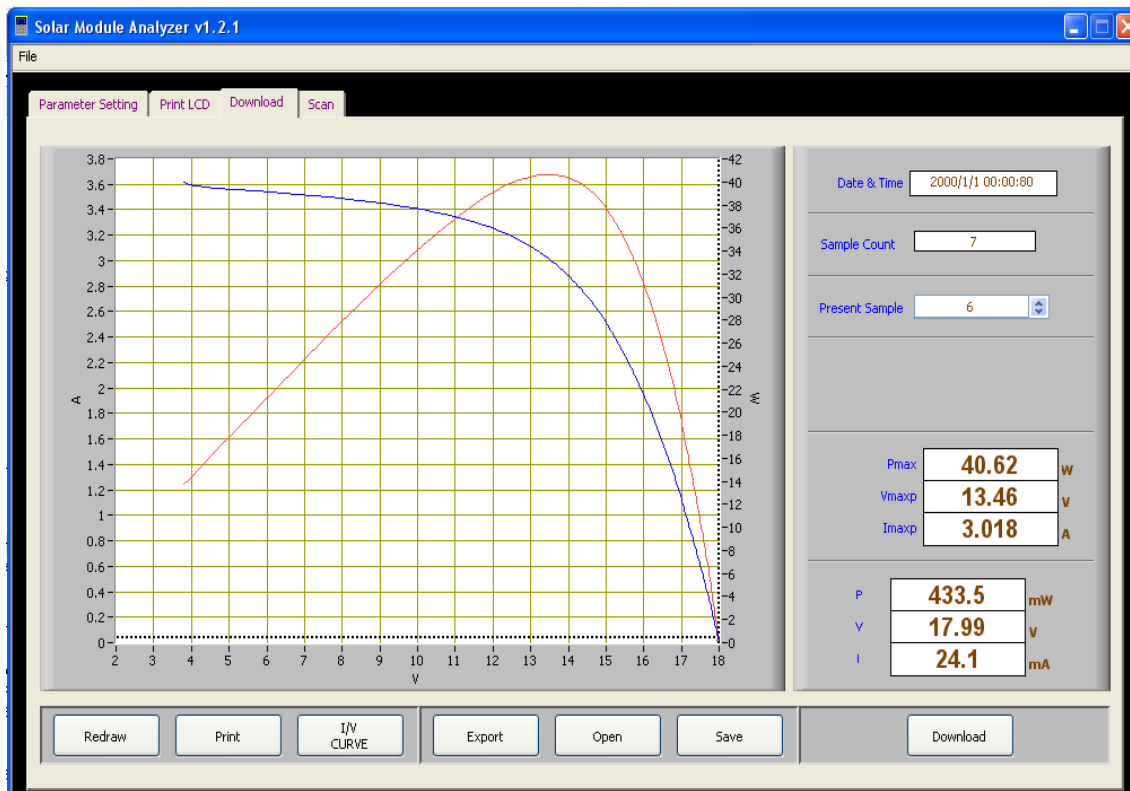
The measured and simulated current, voltage and power of PV module were used as comparison, the comparison based on the measurement and simulation on the solar irradiation of 727 W/m<sup>2</sup> and temperature of 35 °C as represented in Figure 4 to 6. They were also validated using statistical analysis, the validation was expressed by *CRM* , *RMSE* , *NSE* and *e* as represented in Table 3.



**Figure 4** Simulation result of short circuit current versus open circuit voltage of PV module for the solar irradiation of 727 W/m<sup>2</sup> and temperature of 35 °C



**Figure 5** Simulation result of power versus open circuit voltage of PV module for the solar irradiation of  $727 \text{ W/m}^2$  and temperature of  $35 \text{ }^\circ\text{C}$



**Figure 6** Temp Measurement result of power versus open circuit voltage of PV module for the solar irradiation of  $727 \text{ W/m}^2$  and temperature of  $35 \text{ }^\circ\text{C}$



Table 3 Statistical analysis

	Statistical analysis			
	CRM	RMSE	NSE	e(%)
Value	0.0198	0.0085	0.9936	1.958

Table 3 shows that the values of  $CRM$  are closer to zero, they indicates that the validation has high accuracy. The value of  $CRM$  is positive, it indicates that the tendencies of the simulation to underestimate the measured current, voltage and power of PV module. The values of  $RMSE$  are low value, it indicates that the validation has minimal value. The values of  $NSE$  are closer to 1, it indicate that the simulated current, voltage and power of PV module have high accuracy value with the measured data. The values of  $e$  are 1.958 %, it indicate that the simulated current, voltage and power of PV module are acceptable.

#### 4 Conclusion

Under constant solar irradiation and difference temperature, the open circuit voltage and short circuit current of PV module will be influenced significantly and slightly, respectively. The open circuit voltage tends to decrease with increasing temperature.

The validation of measured and simulated PV module performance using statistical analysis shows that the values of  $CRM$  are closer to zero, they indicates that the validation has high accuracy. The values of  $RMSE$  are low value, it indicates that the validation has minimal value. The values of  $NSE$  are closer to 1, it indicate that the simulated current, voltage and power of PV module have high accuracy value with the measured data. The values of  $e$  are 1.958 %, it indicate that the simulated current, voltage and power of PV module are acceptable.

#### 5 References

- [1] Cook, G., Billman, L., and Adcock, R. (1995). Photovoltaic Fundamental. DOE/Solar Energy Research Institute Report No. DE91015001.
- [2] El-Zayyat, H.M., Mahmoud, M. (1988). Photovoltaic Power Generators for Radio Communication System in Jordan. IEE proceedings, Vol. 135, Pt.C, No.5.
- [3] Wu, M.J., Timpson, E.J and Watkins, S.E. (2004). Temperature Consideration in Solar Arrays. IEEE Explorer.
- [4] Ulrick, B. (2007). A Simple Model of Photovoltaic Module Electric Characteristics. IEEE Explore.
- [5] Almorox, J., & Hontoria, C. (2003). Global Solar Radiation Estimation Using Sunshine Duration in Spain. *Energy Conversion & Management*, 1529 - 1535.

## Enzymatic Treatment to Facilitate Removal of Impurities in Raw Unclean Edible Bird Nest (EBN)

Zainab Hamzah<sup>1\*</sup>, Nur Hulwani Ibrahim<sup>1</sup>, Farhani A.Razak<sup>1</sup>, Othman Hashim<sup>1</sup>  
Kamarudin Hussin<sup>2</sup>

<sup>1</sup>School of Bioprocess Engineering, University Malaysia Perlis (UniMAP)  
Kompleks Pusat Pengajian Jejawi 3, 02600 Arau, Perlis, Malaysia

<sup>2</sup>Chancellory, Main Campus, Universiti Malaysia Perlis

\*Contact: Email: [zainab@unimap.edu.my](mailto:zainab@unimap.edu.my) Tel: +6049798512, Fax: +6049798755

### ABSTRACT

Edible Bird Nest (EBN) is the dried glutinous secretion from the salivary glands of the swiftlet species. The tedious process of cleaning the raw unclean EBN can be a setback for the industry to flourish. Cleaning the raw EBN off feathers and other contaminants requires skill and lots of time and labor before it can be marketed and safely consumed. This study is conducted to determine the effectiveness of the use of enzymes to facilitate the cleaning process of EBN to enhance the quality of this food product. Three types of enzymes used were crude bromelain from pineapple, crude papain from papaya and keratinase. Based on the results, the time of cleaning raw EBN using enzymes was significantly reduced from 8 hours to 3 hour per 100g raw EBN. Extraction technique using enzymes also retained the preferred physical structure of commercial EBN. Additionally, the egg like smell when cleaned using hydrogen peroxide is significantly reduced using enzymatic treatments. Enzymatic treatment also increased the protein and carbohydrate content of EBN. Overall, EBN treated with enzymes is better in quality when compared with EBN cleaned using chemicals.

*Keywords: Edible bird nest (EBN), enzymes, cleaning EBN*

### Introduction

The Malaysian Edible Bird Nest (EBN) industry shows incredible growth for the past few years. Malaysia aims to become the number one world producer of EBN and its value added products. The EBN industry is economically viable without endangering the environment. The government's target is to have 63,000 swiftlet houses with a production of 870 metric tons EBN worth RM3.5 billion by the year 2020. Despite the increasing production, the industry is still saddled with a problem of finding a suitable processing technology to clean the raw unclean EBN. Raw EBN is processed by clearing the feathers off from the nests cement after washing briefly in distilled water. The tedious process of picking and clearing the feathers requires skilled and a lot of labor. The process is time consuming due to the size of the feathers that is hardly seen and presence of other impurities.

This study is conducted to determine the effectiveness of using enzyme to facilitate the cleaning process of (EBN). EBN samples treated with bromelain, papain, keratinase and hydrogen peroxide were analyzed using Fourier Transform Infrared (FTIR) spectroscopy to determine the functional groups and chemical compounds present after treatment. The FTIR spectra of EBN from swiftlet species *Aerodramus fuciphagus* after each treatment were measured within the range of 450 -4000 $\text{cm}^{-1}$  wavelength. Different types of enzymes require a different approach in the cleaning process. Bromelain and Papain use to break down the protein contained in EBN itself hence the feather can be easily remove and the mixture of enzyme and EBN will undergo further treatment before it can be used. On the other hand, the use of Keratinase will attack keratine bond presence in the feather without disturbing protein bond presence in EBN. The feather will then be removed from the extract by centrifuging. Sample will then be filtered and feather can be removed.

## Materials and Methods

### 3.1 Acquisition of Raw EBN Samples

Cleaned and unclean Edible Bird Nest (EBN) samples from the swiftlet species *Aerodramus fuciphagus* of the same grade from both cave and house type nest was collected from an EBN farm situated at the northern region.

### 3.2 Extraction of Enzymes

#### 3.2.1 Extraction of Bromelain from pineapple

The whole pineapple including the stem was cut into smaller cubes. The sample was extracted using a blender and the extract was filtered on cheesecloth to remove any remaining pulp. The fresh pineapple juice containing bromelain referred to as “crude bromelain extract” was stored in an airtight container at  $-4^{\circ}\text{C}$  to retain the enzymatic activity of bromelain.

#### 3.2.2 Extraction of Papain from raw papaya

The unripe papaya was cut from top to bottom with a razor blade not more than 2mm deep. The papaya will be held over the collection dish and the latex was allowed to drip out onto the dish. This should be done for a minimum of six minutes. The collection dish was placed into vacuum oven for 5 hours at  $40^{\circ}\text{C}$  to dry the latex. The liquid papain will be ready would turn crumbly in appearance. The dried papain will be transferred into an air tight container lined with polyethylene by gently scrapping it off the collection dish with stainless steel spoon. The container will be stored in a cool dry place below  $2^{\circ}\text{C}$  to be used for further experiments.

#### 3.2.3 Extraction of Keratinase.

Enzyme Keratinase lyophilized was purchased from Sigma-Aldrich. The enzyme was dissolved with 0.5-1.0 mg/mL in sterile water. The keratinase solution was stored at  $-20^{\circ}\text{C}$  for analysis.

### 3.3 Preparation of Raw EBN Materials

The raw unclean bird nest samples were soaked in warm water (40°C) for 1 minute to soften the cement. The samples were separately soaked in different types of enzyme. The treated samples were centrifuged to separate feathers and other impurities. After centrifugation, the feather was removed by filtration and the remaining sample was washed and dried for 24 hours at 60°C in an oven. The dried samples were ground and stored in an air tight container for further analysis.

### 3.4 Nutritional Content Analysis

#### 3.4.1 Moisture Content of EBN

The mass of empty crucible with lid was weighed and recorded. 5g of EBN sample was put in the crucible and with the lid on was placed inside an oven at 105°C for 24 hours until constant weight was attained. The percentage of moisture content can be determined by using the following formula:

#### 3.4.2 Ash Content

5g of the EBN sample was heated in a muffle furnace at 550°C for 4 hours. The ashed sample was cooled and the weight recorded.

#### 3.4.3 Protein Analysis

Total protein was determined according to Lowry method (Pongunaran & Naidu, Simpson, 2012.)

#### 3.4.4 Carbohydrates Content

Carbohydrate analysis was determined using phenol sulphuric acid method. Glucose was used as the standard ranging from 20-100µg per sample (Marcone, 2005).

#### 3.4.5 Fat Content

Fat analysis was determined using the Soxhlet extraction method (Hamzah *et al.* 2013).

## Results and Discussion

The FTIR spectra of EBN from each treatment: A-Bromelain; B-Papain; C-Keratinase; D-Hydrogen Peroxide; E-Control. Results showed the presence of similar compounds that are hydroxyl, alkanes, alkynes, carbonyl, amines II, amide and ester groups. The fingerprint region was similar, around wavenumber of 1500 cm<sup>-1</sup> to 600 cm<sup>-1</sup> for all samples. This shows that all treatment does not alter the chemical properties in the EBN.

Table 1: Functional groups of EBN sample for different treatments.

Functional Group Name	Absorption Ranges (cm <sup>-1</sup> )	Type of Vibration
Hydroxyl	3600-3100	Hydrogen-bonded O-H Stretch
Alkanes	3100-2800	H-C-H Asymmetric & Symmetric Stretch
*the absorption can be seen as several distinct peaks in this region		
Alkynes	2200-2100	C≡C Stretch
Amides	1670-1600	C=O Stretch
Amines-Secondary	1550-1450	N-H Bend
Esters	1300-1000	C-O Stretch

The broad band around 3600-3100cm<sup>-1</sup> is due to the hydrogen bonded O-H stretching. The FTIR spectra shows absorption peaks at 3100-2800cm<sup>-1</sup> and are attributed to the H-C-H asymmetric and symmetric stretching from alkanes group. These symmetric absorption bands were observed at 2960.74 cm<sup>-1</sup> (bromelain), 2960.54 cm<sup>-1</sup> (papain), 2962.69 cm<sup>-1</sup> (keratinase), 2663.20 cm<sup>-1</sup> (hydrogen Peroxide) and 2960.50 cm<sup>-1</sup> (Control). Absorption around 2200-2100 cm<sup>-1</sup> shows the presence of alkynes group due to C≡C Stretch.

Additionally, an absorption peak around 1550-1450cm<sup>-1</sup> shows the presence of amine group due to N-H bend. The FTIR spectra detected an absorption bands around 1670-1600 cm<sup>-1</sup> due to C=O stretch from amides group. This bands indicated the presence of protein in then sample. Other absorption that can be seen were around 1300-1000 cm<sup>-1</sup> that is from C-O stretch presence in ester group that shows the existence of fats in the sample after treatments. Studies by Joe Set (2012) stated that in the spectra, the major band for protein was around 1650 cm<sup>-1</sup> and 1550 cm<sup>-1</sup>, carbohydrate near 1030 cm<sup>-1</sup> and lipids around 2930 cm<sup>-1</sup>.

Overall, moisture content in all EBN samples ranged from 7% to 13% which is within the standard requirement of < 15% (DSM, 2011).

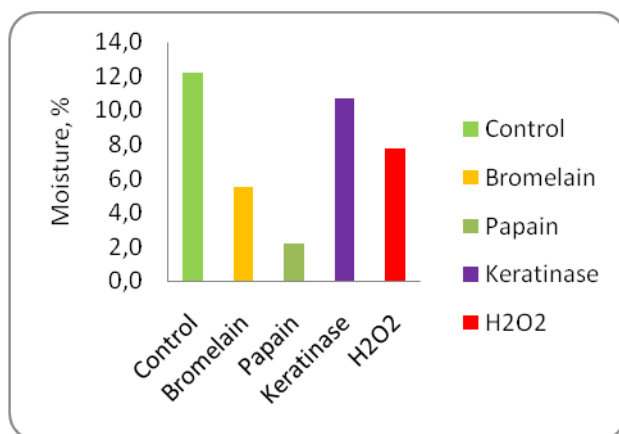


Figure 1: Moisture content in different treatment on EBN

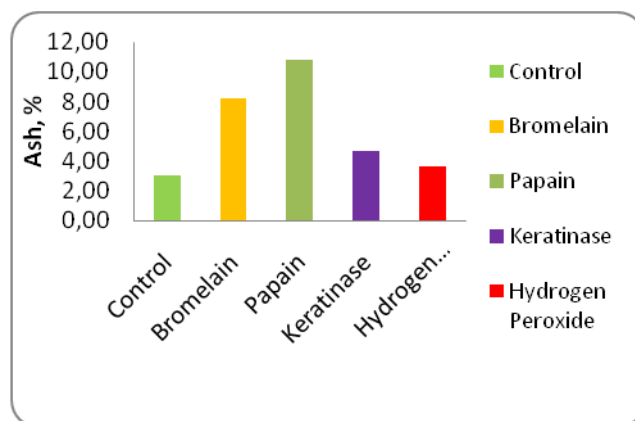
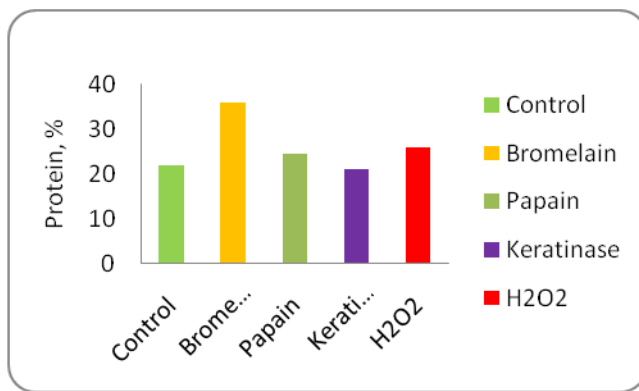


Figure 2: Ash content in different treatment on EBN

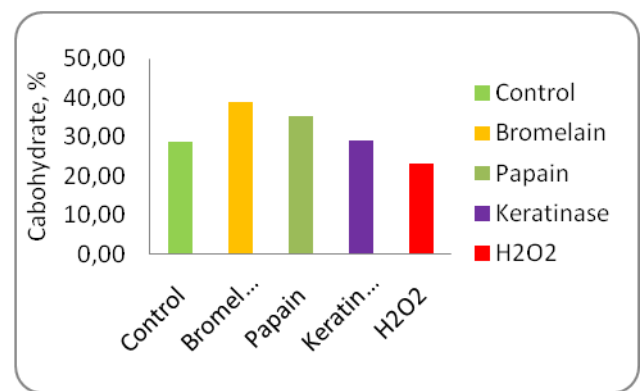
Figure 1 showed treatment with bromelain, papain, keratinase and hydrogen peroxide gave lower amount of moisture compared to control or water treatment. Papain shows the lowest amount with only 2.17%. Moisture in keratinase treated EBN shows significant different amount of moisture (10.7%) when compare to water treatment (12.2%).

It can be clearly seen that, there are a huge difference when treated with papain (10.78%) and bromelain (8.22) in comparison with control (3%). While treatment with keratinase enzyme and hydrogen peroxide gives relatively the same amount of ash in the sample. Keratinase enzyme is a protease enzyme that works specifically on keratin protein so it will only degenerate keratin presence in feathers without not interfere with the content of other nutrients contained in bird's nest and hence lowering the ash value of EBN(Figure 2).

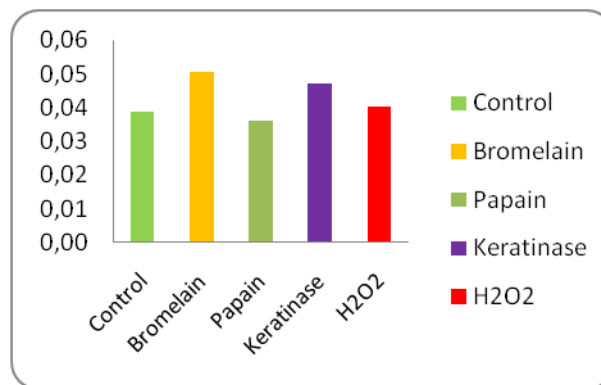
The amount of protein present in different treatment of EBN can be observed in Figure 3. The protein content for all EBN samples ranged from 36%-21%. Bromelain treatment shows almost double the amount of protein (36%) compare to water treatment (22%).



**Figure 3:** Protein contentin different treatment onEBN



**Figure 4:** Carbohydrate contentin different treatment onEBN



### **Figure 5: Fat content in different treatment on EBN**

The carbohydrate content is the second highest component in all EBN samples (Hamzah et al., 2013). Carbohydrate contents of the EBN treated with enzyme bromelain (39.03%) and papain (35.23%) shows significantly higher with an average value of 28.9% from water treatment. On the other hand, treatment with keratinase and hydrogen peroxide was almost similar to water treated EBN (Figure 4)

Test results of fat content for all treatment of EBN are shown in Figure 5 ranging between 0.05% and 0.03% indicated that lipids constituted the smallest measured fraction of all nutritional content. Treatment with bromelain and keratinase shows the highest amount of fat that is approximately around 0.05%. Treatment with papain and hydrogen peroxide shows a slight difference in comparison with water treatment that is around 0.04%.

### **CONCLUSION**

This study is conducted to evaluate the use of enzymes to facilitate the cleaning process of raw EBN in improving the product quality. One of the enzymes tested is bromelain extracted from pineapple. Bromelain is a type of protease enzyme that helps to degrade protein bonds. Both bromelain and hydrogen peroxide, H<sub>2</sub>O<sub>2</sub>, will give the same cleaning effect on EBN. Based on the results, the use of enzymes in replacing hydrogen peroxide as a cleaning agent is proven effective and beneficial. The cleaning time is reduced thus favoring less labor requirement. The physical fibrillar and threadlike structure of EBN is also intact and sustained when cleaned using enzymes. Both techniques, however, require a second feather removing process but the use of enzymes is safer for human consumption compared to chemical cleaning and is environment friendly. The enzymes present in the EBN also add value to the nutritional content of EBN.

### **ACKNOWLEDGEMENT**

The inventors would like to acknowledge the research funding from Ministry of Higher Education Malaysia (MOHE) for the financial support given under KPT (UPM-COE Swiftlet) (9015-00001), SSCM Farm Bird Nest and School of Bioprocess Engineering for their support.

### **REFERENCES**

- Dubois, H., Gilles, K. A., Hamilton, J. R., Rebers, P. A., and Smith, F. (1956). Colorimetric Method for Determination of Sugars and Related Substances. *Analytical Chemistry*, 28, 350–356.
- Hamzah, Z., Sarojini, J., Ibrahim, N. H., Hussin, K., Hashim, O., & Lee, B.-B. (2013). Nutritional Properties of Edible Bird Nest, 3(6), 600–607.

Lowry, O.H., N.J. Rosebrough, A.L. Farr, and R.J. Randall (1951) Protein Measurement with the Folin Phenol Reagent. *J. Biol. Chem.* 193:265-275.  
Marcone, M. F. (2005). Characterization of the Edible Bird's Nest the "Caviar of the East". *Food Research International* 38, 1125–1134.



## Model of Tree Shade Value by Contingent Valuation Technique on the Cocoa Agroforestry of Central Sulawesi Province

<sup>1</sup>Syukur Umar, <sup>2</sup>Indrianto Kadeko

<sup>1</sup> Tadulako University, Jl. Sukarno Hatta Km. 9 Palu, Indonesia, syukur\_umar@yahoo.com, +6285241391765

<sup>2</sup> Tadulako University, Jl. Sukarno Hatta Km. 9 Palu, Indonesia, indrianto\_k@yahoo.com +65081354401133

### Abstract

Agroforestry is a technology of avoiding deforestation and forest degradation and to increase cocoa production. Consider these, UNREDD recommend it as an activity of REDD+ implementation. This study aims to construct a model of the shade economic value in cocoa agroforestry. By using Contingent Valuation, a survey was pursued on 211 respondents in five villages. Multivariate analysis involves one dependent variable (value of tree shade; Y) and eight independent variables. Factor Analysis based PCA used to solve multi-colinearity problem. The scree plot obtained shows two factors with eigenvalue > 1. OLS Linear Regression developed a model  $Y = 35.05 + 3.11 \text{ Fee} + 7.0 \text{ Fse} + \varepsilon$  with  $R^2 = 91.9\%$  where  $\text{Fee} = f(X1; X2; X8)$  and  $\text{Fse} = f(X3; X4; X5; X6; X7)$ . Mean of the shade economic value is IDR 35,000.00 per month per one percent of additional shade in one hectare. The model explain that 35.05 is value predicting Y if Fee (ecology-economic)= 0 and Fse (socio-economic)= 0. 3.11 represent the difference in the predicted value of Y for each one-unit difference in Fee, if Fse remains constant. 7.0 is interpreted as the difference in the predicted value in Y for each one-unit difference in Fse, if Fee remains constant.

**Keywords:** Central Sulawesi. cocoa agroforestry, economic value, model, REDD+, tree shade.

### 1. Introduction

Cacao (*Theobroma cacao* L) is the main cash crop of Indonesia archipelago, especially in Sulawesi Island. The plant produces cacao beans that are exported primarily to Europe and North America to be raw materials for producing cocoa and chocolate. Together cacao and coffee are the largest legal international trade volume beside petroleum (Donald, 2014) which are the crops most commonly grown under shade trees to avoid physiological stress impacting sustainability of the production (Beer *et al.* 1998). Indonesia is the third biggest producer of cocoa beans in the world after Ivory Coast and Ghana. As a big producer, Indonesia yields cocoa beans for either consumed domestically or exported. In national market, the cocoa beans are treated into some intermediate products such as cocoa butter, paste and powder which will be utilized for producing foods and other final products. More a half of cocoa beans production was in export market which contribute 6,7% of total world cocoa export in 2011. Rifin, 2013, explained that Indonesia has a comparative advantage on producing cocoa beans but the other producing countries. Ivory Coast and Gana , has also comparative advantage in producing cocoa beans and their RCA (revealed competitive advantage) index are several times higher than Indonesia.

Growing cacaos under trees is an agroforestry technique that has been an interesting object of researchs and publications. The researchers and authors cite the benefits of the trees such as shade to cocoa, soil fertility maintenance by recycling nutrients in the soil, biodiversity conservation, protection against drought, bush fires and insect attacks and additional income through sales of timber species, fuel wood, and non-wood forest products (Ashare, 2005). Tscharrntke *et al.*,2011, has reviewed shade trees in cacao system due to two raisons (1) have received less attention and (2) tend to be more endangered by recent farming practices. They resumed that most published works explained three raisons supporting shaded agroforestry: shade support the cacao growth, biodiversity conservation, and diversify farming system. Further explanation that although some areas in Africa (e.g Cameroon and Ghana) and Latin America (e.g. Brazil, Mexico) still grow cacao traditionally under permanent shade, and shade reduction that is in ongoing farming process in many parts of the tropics particularly in Southeast Asia including in Central Sulawesi of Indonesia.

Increasing the shade will make an implication in cacao agroforestry system. It can mean to decrease cocoa production than will affect income lost to the farmers. This is also in contra with what the farmers did in establishing their cacao plantation. They have introduced the crop by forming a forest garden and shift to large-scale forest encroachment and forest thinning. Shade removal is still a

practical technique to decrease pest and disease pressure. Not only technical reason behind the shade removal, but a number of socio-economic factors makes the farmers do it, especially as an evidence of an investment. Despite all those arguments of hindering to increase tree shade in the agroforestry, recognizing to the role of the forest and agroforestry biomass on mitigating climate change and global warming is a strategy background to increase the shade as an effort to increase agroforestry biomass. Schroeder, 1993, stated that mature agroforestry should contain in average 70 to 100 t C per hectare. It is a promising stock performance comparing with allowing a forest fallow to regrow and accumulate 35 to 50 t C ha<sup>-1</sup> over the first 40 year period. Agroforestry systems show a significant carbon accumulation and demonstrate the potential of carbon sequestration. Furthermore, agroforestry system can contribute to reduce CO<sub>2</sub> emission by avoiding burning of forest.

The potential of agroforestry to conserve and stock carbon makes this land use system as one of REDD+ activities in Central Sulawesi Province recommended by UNREDD (Epple and Julia, 2013). Agroforestry is not only reducing forest encroachment but also can be an option to increase the density of trees on non-forest land. By combining trees and crops in agriculture land, agroforestry can store and sequester more carbon than conventional agriculture. Furthermore, agroforestry can often be more accessible to local community than intensive monoculture production system due to its lower initial investment need.

This article is aimed to develop a model of economic value of tree shade in cocoa agroforestry by using Contingent Valuation approach. The research was an effort to fill an empty space in the REDD+ policy in order to compact the policy. This will also be a wise attempt to rationalize a decision process making by the farmers in managing their agroforests. The role of agroforestry practices in climate change and global warming mitigation in the province can be realized to its full potential by overcoming various barriers.

## 2. Theoretical framework: economic values, utility under REDD+ scenario

The objective of the tree shade valuation in agroforestry system is to integrate the economic value of the trees services in the plot scale and global scale into the conventional economic decision process pursued by decision makers. Economic value is the prices paid in market and the consumer surplus obtained by the users (Bann, 1998). Barrio and Louerio, 2010, has studied the results of more than thirty studies on forest valuation of the contingent valuation in the world, and they concluded that it is important to aware of citizens' preference when designing forest programs in order to increase their acceptability. Ozturk et al., 2009, argued that estimating forest values is not only as a key role in formulation of a successful forest policy but also as determination of the real contributions of forest resources to sustainable development.

Shaded area below P curve and above S+S<sub>under REDD+ Scenarios</sub> curves in the Figure 1 is the object of the valuation of this research. P curve depicts cocoa production of cocoa agroforestry, and S depicts shade of the agroforestry trees. In point a, there are two choices to do, increasing or decreasing the shade.

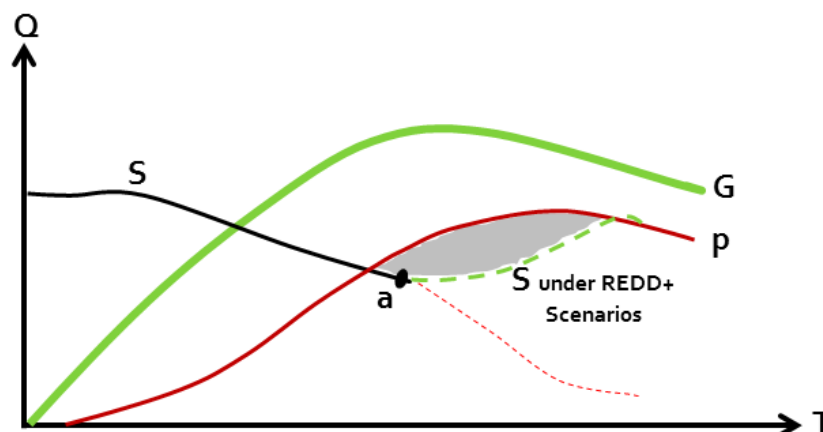


Figure 1. Object of the research by curves illustration.

Since cocoa yield decrease non-linearly with increasing shade, farmers need to remove a part of shading tree in order to keep the increment of cocoa production. Removing the shade will affect carbon emission due to biomass lost from the cocoa agroforestry. Emission from agricultural

activities converts 14% of  $3.5 \times 10^9$  ton C emitted to the atmosphere a year (Paustian *et al.* 2000; WRI, 2005). Somarriba *et al.* (2013) argued that it is possible to design cocoa-based agroforestry with good yield (cocoa and shade canopy) and high carbon stock level. They suggest that the botanical competition of the shade canopy provides a large set of morphological and functional traits that can be used to optimize shade canopy design.

The research estimated tree shade value of cocoa agroforestry by directly asking agroforestry owners to state their preferences about tradeoff between lost and gain based under REDD+ scenario of the contingent valuation. We assumed that the CV survey presented the households with the prospect of securing a change in provision of the tree shades in the agroforestry from its present level ( $Q^0$ ) to a greater level ( $Q^1$ ). Also we assumed that the survey was worded so as to elicit a household's minimum WTA to achieve the change. We constructed an idea that WTA is an expression of household's utility (U) where this will describe the maximum amount of utility a household can derive from their lost (L), given the price of cocoa (P), and the level of provision of the tree shade (Q). It is also assumed that the household's utility will depend on other demographic and economic factors (S). We can write the household's utility function in general form:

$$U(L, P, S, Q) \quad (1)$$

We imagined that under normal circumstance, less lost would enable the household to purchase more goods (tree shade) and hence realize a higher level of utility. Also, we assumed that increasing the provision of the tree shade represent a loss. Thus the utility enjoyed by the household will be at level  $Q^0$  than at level  $Q^1$  of provision, hence:

$$U(L, P, S, Q^0) > U(L, P, S, Q^1) \quad (2)$$

The respondents answered the CV question by comparing their utility at two levels of provision,  $Q^0$  and  $Q^1$ . Since they experience greater wellbeing at the lower level of provision, it is reasonable to assume that the respondents would proposed their willingness to accept as compensation they have due to lost they have at maximum level  $Q^1$  allowed. Indeed the respondent's minimum WTA can be formally described as the monetary value they earn to ensure that their wellbeing with the higher level of provision is just identical to their wellbeing at the lower level of provision. We have defined a quantity C such that:

$$U(L+C, P, S, Q^0) = U(L, P, S, Q^1) \quad (3)$$

C is the compensating variation measure of a change in welfare in the form of the household's minimum WTA to achieve the increase in provision of the tree shade of cocoa agroforestry. After having manipulated the recent equation, C was defined as a function of other parameters in the model. This function, which we denote  $C(\cdot)$ , can be written in general form as:

$$C=C(Q^0, Q^1, L, P, S) \quad (4)$$

Two last equations provided the basic theoretical framework for the analysis of the research data. WTA data was bounded by willingness to accept of the respondents that must be greater than their lost, or in mathematical notation:

$$C(Q^0, Q^1, L, P, S) = WTA \geq L \quad (5)$$

We recognized that the relevant measure of income in this case was discretionary lost. It is about production lost due to tree shade application.

### 3. Research design and methods

The elicitation of individual's valuation preference on tree shade of REDD+ scenarios was done through the contingent valuation (CV) survey on 211 respondents of five village samples (Bunga, Bobo, Kapiroe, Rahmat, and Berdikari) in Palolo sub District, Sigi district of Central Sulawesi Province, Indonesia. The success in eliciting individual expression of value for specific increase of tree shades in the cocoa agroforestry they have is a key of the technique. In this approach, information on the value tree shades is obtained by posing direct questions to the respondents about

their willingness to accept (WTA) cash compensation for losing the benefit. WTA refers to minimum amount of money an individual would asked to cede a good, or give up the right to use it (Riera *et al.* 2012). WTA denotes as Y of dependent variable and independent variables are the results of transformation of equation 5 and we have X1 (estimated lost due to tree shade), X2 (land owned), X3 (number of household members), X4(respondent age), X5(gardening experience), X6(perception on agroforestry), X7(perception on the shade), and X8(maximum shade allowed). We used open-ended format of CV format by letting the respondents determine their WTA freely through face-to-face interviews survey mode. In the other words, we can say that the primary objective of the contingent valuation survey was to discover the value placed on changes in provision of the tree shade intensity by the households in the population.

The analysis uses multivariate analysis by combining factor analysis based principle component analysis with ordinary least square regression. Principle Component Analysis (PCA) is a traditional multivariate statistical method commonly used to reduce the number of predictive variables and solve the multi-collinearity problem (Johnson and Wichern, 1988). Principal component analysis looks for a few linear combinations of the variables that can be used to summarize the data without losing too much information in the process. There are eight of independent or explanatory variables and one of dependent or respond variable as sources of the data. In manipulating, analyzing, and presenting the data; we used SPSS 21 for Windows. By the package we began the analysis with the calculation of a number of summary statistics such as mean, median, standard deviation, etc., and by creating informative graphical displays of the data such as histograms, box plots, and stem and leaf plots. This is the descriptive statistics stage that aims to describe the general distributional properties of the data, to identify any unusual observations or any unusual patterns of observation that may cause problems for later analysis to be carried out on the data. The whole stages of data analysis are shown by the scheme (Figure 2).

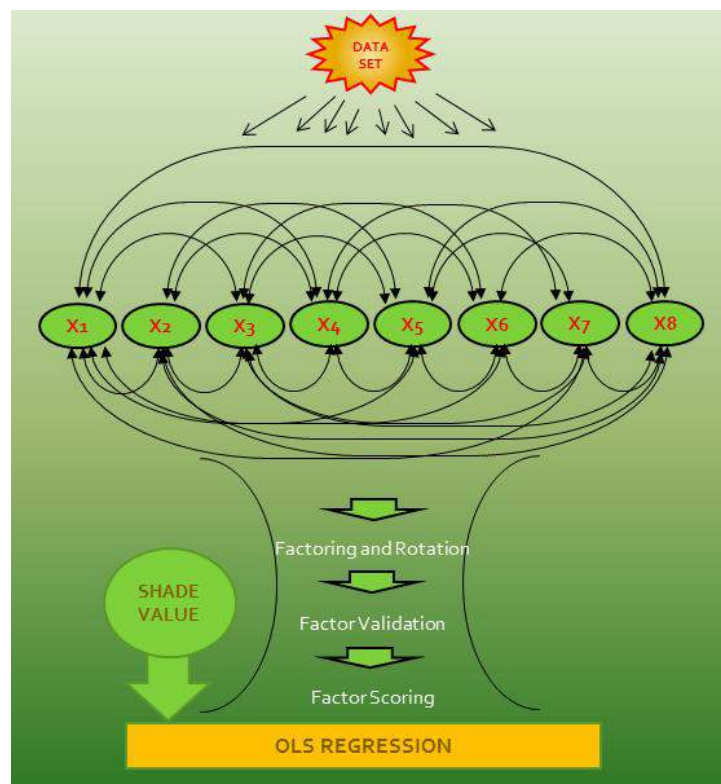


Figure 2. Scheme describing data analysis.

The starting point of the analysis is pursuing descriptive statistics and the starting point of PCA is preparing the correlation matrix. The purpose of descriptive statistics is to describe the basic feature of the data, and correlation is important since PCA is mainly concerned with identifying correlation in the data. Correlation measures the simultaneous change in the value of the variables. The correlation

could consist of correlation “R”, partial correlation, anti-image correlation. The whole analysis are (1) data preparation, (2) observed correlation matrix infection, (3) statistics to asses suitability of dataset for basic of PCA, (4) factor extraction, (5) factor rotation, (6) factor name attribution, (7) factor score interpretation.

#### 4. Results and discussion

The sample data that we used was data to make inference to parent population. By pursuing descriptive analysis will give an important answer on whether the data representing the parent population or not. That is way we begun data analysis by examination of relevant summary of descriptive statistics.

Table 1. Summary of descriptive statistics of the research data

Description	Variables								
	Y	X1	X2	X3	X4	X5	X6	X7	X8
Mean	34.98	33.87	1.50	3.85	45.15	31.93	2.90	3.08	31.67
Standard Error	0.53	0.79	0.03	0.09	0.92	0.91	0.06	0.07	0.49
Median	35.00	34.00	1.50	4.00	45.00	32.00	3.00	3.00	20.00
Mode	35.00	34.00	1.50	3.00	30.00	17.00	3.00	4.00	15.00
Standard Deviation	7.73	9.43	0.46	1.24	13.33	13.19	0.89	1.06	7.09
Sample Variance	59.69	130.73	0.21	1.55	177.57	174.09	0.79	1.13	50.32
Kurtosis	-0.51	0.28	0.06	-0.09	-0.49	-0.69	0.28	-0.97	-0.42
Skewness	0.03	-0.11	-0.01	0.59	0.35	0.34	0.25	-0.13	0.94
Range	30.00	52.00	2.00	5.00	55.00	50.00	4.00	4.00	20.00
Minimum	20.00	10.00	0.50	2.00	20.00	10.00	1.00	1.00	19.00
Maximum	50.00	62.00	2.50	7.00	75.00	60.00	5.00	5.00	42.00
Sum	7345.00	7743.00	316.00	808.00	9481.00	6706.00	608.00	646.00	4550.00
Count	211.00	211.00	211.00	211.00	211.00	211.00	211.00	211.00	211.00
Confidence Level (95.0%)	1.05	1.56	0.06	0.17	1.81	1.79	0.12	0.14	0.96

Table 1 shows results of measuring the central tendencies that provide a convenient way to describe the data with a single number of the mode, the median, and the mean. Although the modes of X5 and X8 are significantly different with the means and the medians, we can say that data presenting the meaningful means. This is in line with values of kurtosis and skewness that indicate that the means fall into normal distribution curves, the data are evenly distributed around the mean. Furthermore, in the fifth line of the table above shows the counterparts of the central tendencies those are the standard deviations. The counterpart indicates that 99% of the scores of data are in the range of normal distribution.

Comparing variable tree shade value or WTA (Y) with variable lost (X1), they have nearly similar means and central tendencies but more different of standard deviations. Mean of Y is greater than mean of X1 and this in line with equation 5. Almost all scores of Y fall between 11.8 (IDR 11,800.00) and 58.2 (IDR 58,200.00) meanwhile all scores of X1 are in between 5.7 (IDR 5700.00) and 68.2 (IDR 68,200.00). This imply that the scores belong to Y are closer together than the scores belong to X1. Similar means are being showing by X5 and X8 but quite different on standard deviations where scores of X8 are closer together than scores of X5.

In the theoretical framework we have explained the demographic and economic factors (S) as one of the determinant factors for the utility expression. The S factor in this research consists of six variables (X2, X3, X4, X5, X6, and X7). While X1 representing L factor and X8 representing Q factor. The complexity of the variables is interesting and suitable for using Principle Component Analysis as a widely used mathematical tool for height dimension data analysis. The complexity is an indicator of the presence of multicollinearity or linear codependency among the variables. PCA is useful to reduce a complex dataset to one of lower dimensionality to reveal any hidden, simplified structures that may underlie it. The dataset will be projected to a new coordinate system by determining the eigenvectors

and eigenvalues of the matrix. We agree to use this method in order to have a good regression equation that more simple and easier to understand. Linear regression assumption is that the independence variables are not significantly correlated. When highly intercorrelated predictors are used in a multiple regression model, multicollinearity will be the cause of imprecise and unstable estimates of the regression coefficients. Furthermore, including too many variables may result in an undesirable effect of over fitting the model and making it able to predict even the smallest variations from noise in the observed data but with a low predictive skill.

Correlation matrix as presented by Table 2 is a starting point of PCA, in which the intercorrelations between the studied variables are presented. The analysis will clump subgroups of the variables together and try to get a feel for what the factors are going to be just by looking at the matrix and spotting clusters of height correlation between groups of variables. We used the coefficient correlations (Pearson's product-moment) to measure the degree or the strength of the relationship.

Table 2. Pairwise correlation of the variables

	X1	X2	X3	X4	X5	X6	X7	X8
X1	1.00							
X2	0.95	1.00						
X3	-0.17	-0.13	1.00					
X4	-0.07	-0.04	0.36	1.00				
X5	-0.05	-0.04	0.29	0.95	1.00			
X6	0.35	0.35	0.12	0.52	0.50	1.00		
X7	0.29	0.27	0.25	0.67	0.69	0.61	1.00	
X8	0.82	0.80	-0.06	0.01	0.00	0.31	0.25	1.00

The above table shows positive and negative coefficients. A positive coefficient presents a direct correlation while a negative coefficient presents an inverse correlation. Variable X1 for example presents direct correlations with X2, X6, X7, and X8, while the rests are the inverse correlations (X3, X4, and X5). We have just X6 and X7 that present direct correlations with other variables, while the rests present both direct and inverse correlations. Beside the sign of the correlations, we have as well as the magnitude describing the strength of the correlation. By considering all X variables, we can categorize 15 coefficients presenting weak correlation ( $0 < |r| < .3$ ), 8 coefficients presenting moderate correlation ( $.3 < |r| < .7$ ), and 3 coefficients presenting strong correlation ( $|r| > .7$ ). The highest is 0.95 of Lost (X1) with Land owned (X2) correlation while the lowest is 0.0 (there is no correlation) of X5 (gardening experience) with X8 (max. Shade allowed). The matrix shows the same sign and magnitude of relationship (-0.04) presenting by X2, X4, and X5.

Among all coefficients of the simple correlation, there are three coefficients with values  $\geq 0.8$  than we can diagnose that there is multicollinearity between variables. Multicollinearity can be detected by more ways such as looking at the determinant of the R-matrix, tolerance coefficient and the variance inflation factor (VIF). SPSS output shows four variables with  $< 1$  of tolerance and  $> 10$  of VIF (X1, X2, X4, X5). To persuade of using PCA, we pursued KMO test (Kaiser-Meyer-Olkin) and Bartlett's Sphericity Test. Sampling adequacy of Kaiser-Meyer-Olkin measure is 0.733 while significance of Bartlett's test of sphericity is 0.000. The KMO index of measuring sampling adequacy (MSA) compares the value of correlation between variables and those of partial correlation. Due to the KMO index is high, the PCA can act efficiently.

The Bartlett's test checks if the observed correlation matrix diverges significantly from the identity matrix. In order to measure the overall relation between the variables, we compute the determinant of the correlation matrix  $|r|$ . Under  $H_0$ ,  $|r| = 1$ ; if variables are highly correlated, we have  $|r| = 0$ . The result indicates to reject the null hypotheses at the 5% level ( $p$ -value =  $0 < 0.05$ ). We can perform efficiently PCA on the data set. Both KMO index and the Bartlett's test allow making a summary of information provided by the initial variables in a few number of factors. Anti Image Matrix works to decide which variables will be included in PCA and it gives result that we have good values for all variables for the MSA ( $> 0.5$ ).

To extract the principle components, we used scree test as a device for deciding on the number of components to retain. The scree test is a plot with eigenvalues on the ordinate and component number on the abscissa. In a scree plot, scree is those components that are at the bottom of the sloping plot of eigenvalues versus component number. For each principal component, the

corresponding eigenvalue is plotted on the y-axis. The plot provides a visual aid for deciding at what point including additional components no longer increases the amount of variance accounted for by a nontrivial amount. By definition the variance of the components is smaller than the preceding one. Here is the scree plot produced by the SPSS:

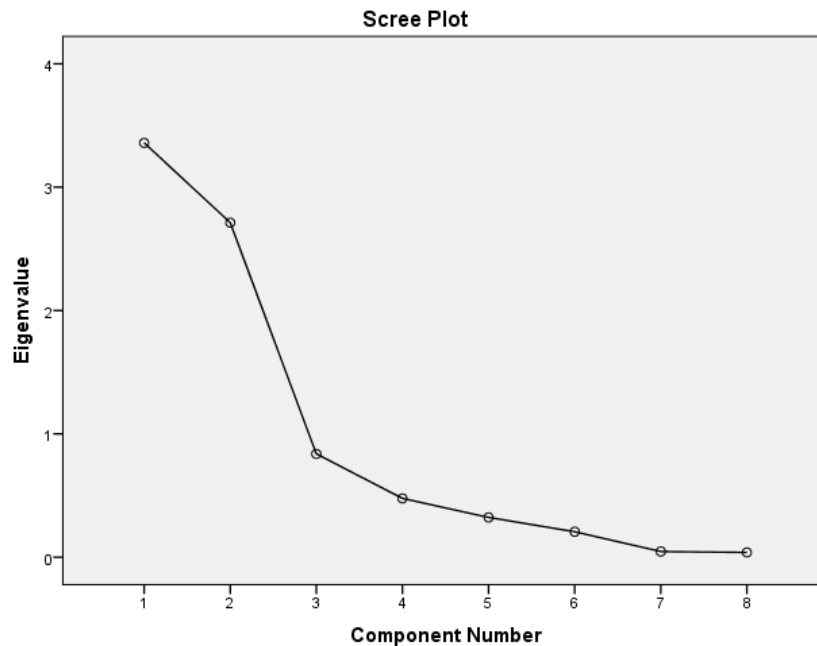


Figure 3. Device to decide a number of components.

The scree plot demonstrates each component less than the preceding one (Figure 3). We are interested to the style of the decrease. Due to the curve shows an “elbow” at 2 to 3 values on the component number axis, this is taken as indicating that highest order principal components contribute a decreasing amount of additional variance and so might not be needed. Here there appears to be marked decrease in downward slope after the second principal component implying that we can summarize the eight variables by the first two principal components. There is a big drop in eigenvalue between component 2 and component 3. The two components have eigenvalues greater than 1. On the scree plot, component 3 through 8 would appear as scree at the base of the cliff composed of component 1 and 2. The two principal components account for 76% of the total variance.

The principal component scores of selected components (C1 – C8) are used as predictor variables for OLS regression analysis. The results revealed that multicollinearity was removed and only C1 and C2 were found to be statistically significant, as shown in Table 3.

Tabel 3. OLS Regression based on principal component scores

Predictor	Coefficient	SE	T	P	VIF
Constant	35.05	2.41	9.36	<0.001	1.00
C1	3.11	1.97	23.46	<0.001	1.00
C2	7.0	0.47	2.65	0.01	1.00

We name C1 as ecology-economic (Fee) and C2 as socio-economic (Fse). The model can be written as:

$$Y = 35.05 + 3.11 \text{ Fee} + 7.0 \text{ Fse} + \varepsilon \quad (6)$$

Where Y is the tree shade value as dependent variable that we are trying to predict, Fee (ecology-economic factor) and Fse (socio-economic factor) are independent variables we are using to predict Y; where Fee= f(X1, X2,X8) and Fse= f(X3, X4, X5, X6, X7). The equation shows that 35.05 of the Y-intercept can be interpreted as that the value we would expect an average the tree shade value of

IDR 35.05 (x IDR 10,000.00) if both Fee and Fse are zero. The coefficient of ecology-economic in unit is IDR 3.11(x IDR 10,000.00). The coefficient indicates that for every additional unit in ecology-economic factor we can expect the tree shade value (Y) to increase by an average of IDR 31,100.00. Similarly, 7.0 is interpreted as the difference in the predicted value in Y for each one-unit difference in Fse, if Fee remains constant.

The coefficient of multiple determination is 0.919; therefore, about 91.9% of the variation in the tree shade value is explained by ecology-economic factor (Fee) and socio-economic factor (Fse). The regression model appears to be very useful for making predictions since the value of  $R^2$  is close to 1.

One of the most basic results of the research is indicated by equation 6 that shows how natural and social aspect of the tree shade value in the perspective of economic interest will contribute to establish sustainable development concept into REDD+ implementation based cocoa agroforestry system. Even though the two factors give positive contribution to tree shade value, they have different parameter values that reflect the weighting of the factors in determining the utility for the tree shade value in the form of WTA as depicting by Figure 4. To the two tree shade values curves  $Y_a$  and  $Y_b$  in panel (a) there corresponds two marginal tree shade values  $MY_{Fee}$  and  $MY_{Fse}$  in panel (b). The tree shade curve  $Y_a$  in panel (a) is identical with  $MY_{Fee}$ . Correspondingly, the marginal tree shade value based socio-economic factor curve ( $MY_{Fse}$ ) in panel (b) is identical with the tree shade curve  $Y_b$ . Farber et al., 2002, explained that when utility are measurable in monetary WTA compensation, the parameters represent the marginal monetary value of each characteristics.

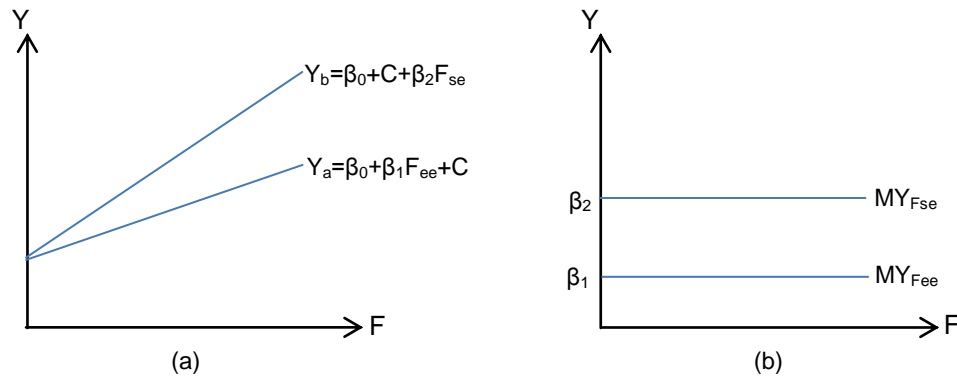


Figure 4. The factors and the tree shade value.

Mean of the tree shade value is IDR 35,000.00 per month per one percent of additional shade in one hectare cocoa agroforestry. Table 1 shows us the mean of tree shade allowed by respondents is 31.67%, while minimum and maximum shade allowed are 19% and 42%. Mean of actual tree shade practiced by the farmers is 18%. By enhancing tree shade or cover will increase the environmental global function and this make farmers have an opportunity to earn new cash from REDD+ mechanism. Agroforestry was recognized by Intergovernmental Panel on Climate Change as having potential for sequestering carbon as part of climate change mitigation strategies (Watson et al., 2000). Not only its global function, agroforestry also can play its local role in improving livelihood as it offers multiple benefits and opportunities to farmers to improve land production and incomes. Its global function is to provide protection on biological diversity, healthy ecosystem, protection of soil and water resource, and terrestrial carbon storage.

Tree shade will give advantage to eight years old of cacao plants under the trees (*Albizia* sp) by increasing cocoa biomass and nutrient uptake (Isaac *et al.*, 2007). Aboveground dry matter of cocoa increased with shade, and declined along a spatial gradient away from shade trees. Light availability under the shade trees was within the optimal range for cocoa production. Most aspect of nutrient cycling will be directly affected by the choice of shade species since these species differ significantly in aboveground biomass productivity, rate of biomass decomposition and fine root biomass productivity (Beer *et al.*, 1998). The farmers in the research site have and can provide detailed information on cocoa management and yields but little was known about tree growth, species and management. Nunoo *et al.*, 2014, explained curves that depict the average yield of cocoa per hectare of the full sun, low shade, medium shade and heavy shade were 794 kg/ha, 696 kg/ha, 735 kg/ha and 546 kg/ha respectively. The yield curve under the full sun system shows a sharp rise in the yield and



followed by a very sharp fall in the yield after age 16. The medium shade has a gradual yield till it peaks at age 19 followed by a gradual fall in yield till age 80. Even though medium shade level have good enough yield but less than the full sun, farmers in many parts of the world, including in the research site are converting shaded cacao into unshaded monocultures to increase short-term income.

## 5. REDD+ implementation?

Recognition to allow tree shade in cocoa agroforestry up to 32% is a strong factor of this land use system to be one of REDD+ activities in Central Sulawesi Province. The constraint of agroforestry to be included into REDD+ mechanism was in a question of whether agroforestry categorized as forest or not. A land is categorized as a forest when the tree cover of the land is at least 30%. Although the pristine natural forest ecosystem represent the largest vegetation and soil C sinks, the need for transforming some of the lower biomass land uses to carbon-rich tree based system such as agroforestry therefore assumes significances. In Central Sulawesi as well as in diverse ecoregions around the world, agroforestry system with more than one billion hectares has a special relevance in this respect of REDD+ implementation. Agroforestry, due to its woody perennial system has relatively high capacity for capturing and storing atmospheric CO<sub>2</sub> in vegetation, soils, and biomass products.

It is clear from above that cocoa agroforestry have the potential to be involved in REDD+ implementation. Furthermore, with adequate management of trees in the agroforestry land, a significant fraction of the atmospheric C could be captured and stored in plant biomass and in soils. C storage in plant biomass is only feasible in the perennial agroforestry system, which allow full tree growth and where the woody component represents an important part of the total biomass (Albrecht and Kandji, 2003). Tscharntke *et al.*, 2011, stated that the trees in agroforestry can be also viewed as “stored capital” providing economy and ecology benefits if families are in need, as well as in reducing vulnerability to environmental, economic or social shock, e.g. dramatically falling prices as was the case in cocoa in the late 1980s to early 1990s. The same is true for fruit trees such as avocado and mango, which provide shade, shrubs and income security.

Ofuoku and Uzokwe, 2014, have worked on acceptance of climate change by rural farming in Nigeria, and they concluded that the acceptance is manifested in form of climate change awareness by the farmers. They explained furthermore the role of science as essential part for the success of future farming in the region. Hamakers, *et al.*, 2012, stated that knowledge gaps and limited capacities inhibit the timely and large scale implementation of REDD+. Capacity gaps and large data has to be addressed in order to have REDD+ outcomes can be measured, reported on and verified (MRV).

Preparing and including cocoa agroforestry as one of REDD+ activities to be implemented mean to make a combination of good (cocoa beans) and environmental services (carbon sequestration and sink) productions. REDD+ could propose the *commodification* of agroforestry's primary production by conserving carbon storage and sequestration functions from other services providing by the ecosystem. REDD+ will make a transfer of economic resources from carbon offset buyer to seller with payments being conditional to the adoption of sustainable land-use practices and delivery of carbon sequestration or emission reduction against national or project-based baselines. To make cacao agroforestry ecosystem services the basic of the carbon conservation strategies is to recognize – intentionally or otherwise- that the agroforestry is only worth conserving when it is profitable. Managing the agroforestry for the provision of its ecosystem services requires of continuous commitment in order to warranty emerging trade-off across spatial and temporal scales, and to track change in local well-being in the short and long term.

We are sure that cocoa agroforestry can contribute to mitigation of global warming and climate change as well as in the same time delivering multiple benefits to the owners who are exposed to the decreased production, high disease burden, climate variability, poverty, land degradation, and forest encroachment. Not only in private land but also in forest land, the agroforestry can be used as an effective technology of the land management based REDD+. Persistent willingness to grow the spirit of REDD+ based cocoa agroforestry in existing policies such as farm forestry (*hutan rakyat*) and forest management unit (*Kesatuan Pengelolaan Hutan*) in Indonesia has to be a good combination of strength and opportunities of cocoa agroforestry in supporting REDD+ implementation. Through the contexts, the farmers should achieve their needs by gathering multiple benefits of the agroforestry and having positive participation and new income from the mitigation of climate change due to carbon accumulation in the tree biomass of the agroforestry. In the context of farm forestry, the farmers will be as the key actors, while in the context of the forest management unit, they can be the key participants of forest management. In the last one they will be accommodated by local and central governments to have a formal right for managing the forest.

Evidence of the results and existing theories, we present scenarios of REDD+ implementation based cocoa agroforestry with eighty years of project period as being showed by Figure 5. The figure is demonstrating a challenge and opportunity applying cocoa agroforestry in land management. We have four curves and one line in the graph, which are curves A, A', A'' presenting yield and or value of cacao under full-sun, and curve B presenting yield and or value of cacao agroforestry under medium shade. We proposed line L as a reference line of tree shade compensation.

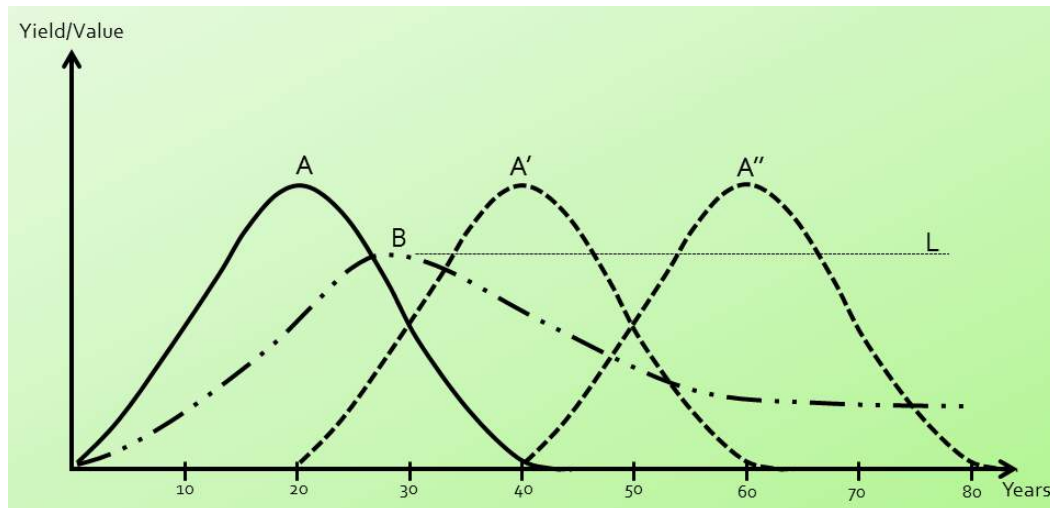


Figure 5. Scenario of REDD+ implementation based cocoa agroforestry (B), with full sun cacao as reference (A).

Value of tree shade compensation could be above or below L line. It depends on whether cocoa agroforestry is implemented in forest area or in private land. In the private land, a farmer could make cacao plantation by Scenario A and prepare to make replantation when the yield or value decreasing (A', A''). In the other word, the farmer is not under REDD+ policy and keep his preference of maximizing cacao production.

Under REDD+ program, cocoa agroforestry could be as a climate-smart agriculture of conservation agriculture in order to deliver significant carbon mitigation and reduced greenhouse gas emission. By referring on some results of researches, Kaczan *et al.* (2013) has reported in FAO Working Paper that agroforestry could sequester up to 19 tones C ha<sup>-1</sup> year<sup>-1</sup>, depending on the type, location and management regime. And this could be as considerable evidence that cocoa agroforestry can lead to large carbon sequestration benefits by expanding it under the program.

## 6. Conclusion

We hope to have provided a relevant work supporting REDD+ policy and implementation. This work will be as a social acceptance of the farmers to this global awareness. This local social acceptance has been in the model describing socio-economic-ecological dimension of sustainable development values. We are glad to know that the thought of the farmers has been maintained by those dimension value. In respect, we expect to have highlighted relevant points for a REDD+ research agenda which is both scientific and political relevant.

## Acknowledgements

The development of this article and issues were supported by the Research Program of Tadulako University, Central Sulawesi of Indonesia.

## References

- Albrecht, A. Kandji, S.T. (2003). Carbon sequestration in tropical agroforestry systems. *Agriculture Ecosystems& Environment* 99 15-27. Elsevier.
- Ashare, R. (2005). Cocoa Agroforestry in West Africa: a look activities on preferred trees in the farming systems. *Forest and Landscape Working papers* No 6-2005.

- Bann, C. (1998). The Economic Valuation of Tropical Forest Land Use Option: a manual for researchers. EEPSEA-IDRC.
- Barrio, M. Loureiro, M.L. (2010). A meta-analysis of Contingent Valuation forest studies. *Journal Ecological Economics* 69 (2010) 1023-1039. Elsevier.
- Beer, J., Muschler, R., Kass, D. & Somarriba, E. (1998). Shade management in coffee and cacao plantations. *Agroforestry Systems*, 38, 134–164.
- Donald, P.F. (2004). Biodiversity impacts of some agricultural commodity production systems. *Conservation Biology*, 18, 17–37.
- Epple, C. and Julia, T. (2013). Option for REDD+ action: what are their effects on forests and people?: an introduction for stakeholders in Central Sulawesi. UNREDD Program.
- Farber, S.C. Costanza, R. Wilson, M.A. (2002). Economic and ecological concept for valuing ecosystem services. *Ecological Economics* 41. 375-392. Elsevier.
- Hamakers, V.J.I. Gupta, A. Herold, M. Claros, P.M. Vije, J.M. (2012). Will REDD+ work? The need for interdisciplinary research to adress key challenges. Elsevier: *Current Option in Environmental Sustainability*. 4: 590-596.
- Isaac, M.E. Timmer, V.R. Timmer, Q, S, J.(2007). Shade tree effect in an 8-years old cocoa agroforestry system: biomass and nutrient diagnosis of *Theopbroma cacao* by Vector Analysis. Springer Science+Business Media B.V.
- Johnson, R. A. Wichern, D. W.(1988). *Applied Multivariate Statistical Analysis*. Second Edition. Prentice Hall. Englewood Cliffs. New Jersey.
- Kaczan, D. Arslan, A. Lipper, L. 2013. Climate-Smart Agriculture? A review of current practice of agroforestry and conservation agriculture in Malawi and Zambia. *ESA Working Paper No. 13 – 07*. FAO.
- Nunoo, L. Owusu, V. Darko, O.B. (2014). Cocoa agroforestry a bridge for sustainable organic cocoa production. *Proceeding of 4<sup>th</sup> ISOFAL Scinetific Conference*. Istambul Turkey.
- Ofuoku, U.A. Uzokwe, N.U., (2014), Acceptance of climate change by rural farming communities in Delta State, Nigeria: Effect of science and government credibility. *Asian Journal of Agriculture and Rural Development* 4(6) 2014: 372-380.
- Omarriba, E. Rolando, C. Luis, C. Miguel, C. Hector, D. Tania, Z. Henry, M. Guadelupe, A. Estefany, A. Veronica, P. Carlos, A. Eduardo, S. Oliver, D. (2013). Carbon stock and cocoa yileds in agroforestry system of Central America. *Journal of Agriculture, Ecosystems and Environment*. Vol. 173 46 – 57. Elsevier.
- Ozturk, A. Turker, M.F. Pak, M. (2009). Economic valuation of externalities linked to Turkish forests. *African Journal of Agricultural Research* Vol. 4 (11). Pp. 1251-1259.
- Paustian, K., Six, J., Elliott, E.T., Hunt, H.W. (2000). Management options for reducing CO<sub>2</sub> emissions from agricultural soils. *Biogeochemistry* 48, 147–163.
- Riera, P. Signorello, G. Thiene, M. Mahieu, P.A. Navrud, S. Kaval, P. Rulleau, B. Mavsar, R. Madureira, L. Meyerhoff, J. Elasser, P. Notaro, S. Salvo, M. Giergiczny, M. Dragoi, S. (2012). Non-market valuation of forest goods and services: good practice guidelines. *Journal of Forest Economics*. G Mode JfE-25166.12. Elsevier.
- Rifin, A. (2013). Competitiveness of Indonesia's cocoa beans export in the world market. *International Journal of Trade, Economics and Finance*, Vol. 4, No. 5, 279-281.
- Schroeder, P. (1993). Agroforestry System: integrated land use to store and conserve carbon. *Climate Research*. Vol, 3, 53-60.
- Tscharntke, T. Clough, Y. Baghwat, A.S. Buchori, D. Faust, H. Hertel, D. Holcher, D. Junrbandt, J. Kessler, M. Perfecto, I. Sceber, C. Schroth, G. Veldkamp, E. Wenger, C.T. (2011). Multifunctional shade-tree Management in tropical agroforestry landscapes – a review. *Journal of Applied Ecology*. British Ecological Society.
- Watson, R., I. Noble, B. Bolin, N. Ravindran, D. Verardo, D. Doken. (2000). *Land Use, Land Use Change and Forestry*. Intergovernmental Panel on Climate Change, Cambridge University Press, Cambridge, UK.
- World Resource Institute, (2005), *Climate Analysis Indicator Tool (CAIT)*, navigating the number greenhouse gas data and International Climat Policy. [www.lowcarboneyconomy.com](http://www.lowcarboneyconomy.com) (accessed May 2014).

## **DISASTER RISK REDUCTION AS THE HUMAN INVESTMENT AND SUSTAINABLE DEVELOPMENT**

**Dr. Ir. Muhammad Dirhamsyah.**

Head of Study Program of Master in Disaster Science,  
University of Syiah Kuala, Darussalam  
Head of Professional Advisor to Aceh Disaster Management Agency  
Government of Aceh, Banda Aceh

### **Abstract**

The great disaster, Great Hanshin-Awaji Earthquake in 1995-Kobe and in the region of the Hindia Ocean in 2004, has given a lesson learn on how importance the implementation of disaster risk reduction (DRR) concepts, with local wisdom approach. The DRR concepts is a direct investment in humanitarian matter giving protection, rescue, and minimising the risk before disaster happened. The DRR implementation has well-suited through local culture, able making method on building culture, regulation, and structure in a region, sustaining and beginning through education. The frame concept of Hyogo action, and also the Act Number 24 of 2007 on Disaster Management, have been giving the reference and also legal guidance in handling disaster impact, in accordance with the disaster cycle that began in the condition before, during and after a disaster conditions. Today conditions such as the dynamics of Earth, extreme weather, epidemic of diseases, technology failures must be given a serious concern, and also a better understanding to reduce disaster risk in the human life environment. The Innovation and creativity in the implementing DRR have to be increased, as the human investment and the better sustainable development.

**Key words: Disaster Risk Reduction (DRR), Investment and Sustainable Development**

### **Introduction**

The disaster prevention occurring in the sustainable development has needed to do a balance to the readiness of supply chain, infrastructure and also the ability of human resources, based on the circle of disaster; that are pre-disaster, at disaster, and post-disaster. The investment ability and availability of infrastructure, resources, equipment, culture and policies to reduce disaster risk needs to be done early during the pre-disaster. In the pre-disaster event, including aspects of disaster preparedness and mitigation, is the first step in preparing a strategic plan, and also the availability of local capacity in disaster management, considering at the time of the disaster and post-disaster. In other words, in times of disaster and post-disaster are the applied application of strategic planning, consisting the availability of structural capability and the ability culture (non-structural), in anticipation of disaster with an umbrella policy, protected by applicable law.

The inventory of equipment in times of disaster and post-disaster are determined by the risk knowledge. That are based on systematic data on disaster risk maps, created on the type of threat and the magnitude of the disaster, as well as efforts to empower them in ways appropriate to reduce injuries, loss of life and damage to property and the environment. Post Kobe earthquake in 1995 and tsunami disaster in 2004 in the Indian Ocean region, have made the cross-sector operations in the management of post-disaster emergency response, becoming a very attracted attention of researchers and practitioners [1].

Aceh's tsunami victims estimated 200,000 people, and the absorption of post-disaster relief fund tsunami in Aceh was estimated at 4.45 billion USD; that has provided a lot of learning on how governments and communities build a better return on time and the target [2]. During five years have been built 140 304 houses, 1,759 schools, 1,115 health facilities, 996 government agencies buildings, 363 bridges, 23 seaports, 13 airports, and roads along 3,696 km [3][4]. When the disaster victims in Japan in 1995 reached 6402 dead, 3 missing and 40.0092 wounds, the absorption of funds reached approximately to ± 10 trillion yen. That were 5.8 trillion for building, railroads 343.9 million yen, 550 million yen highways, ports and docks 1 trillion yen, reclaimed island of 6.4 million yen, 335.2 million yen schools, agriculture and fisheries 118.1 million yen, electricity and gas 420 million yen, broadcast and communications 120.2 million yen, commerce and industry 630 million yen and public facilities amounting to 75.1 million yen. [5]

### **The Disaster Cycle**

The disaster cycle in disaster management, based on the the Act Number 24 of 2007 on Disaster Management, includes stages, namely [6];

- a. Pre-disaster, where disaster management operations during is not a disaster situation and the situation that is a potential disaster;
- b. Emergency response, where assessment is done quickly and appropriately to the location, including damage and resource, determining the status of a state of emergency, rescue and evaluation of the affected communities, meeting basic needs, protection of vulnerable groups, recovery immediately the vital infrastructure and facilities;
- c. Post Disaster, where do the rehabilitation and reconstruction.

### **Humanity, local Culture and Sustainable Development**

In the Act Number 24 of 2007 on Disaster Management, disaster risk is defined as the potential loss caused by disasters in a region and a period of time which can be death, injury, illness, life is threatened, lost sense of security, displaced, damage or loss of property, and disruption of community activities. While one of the DRR program is the responsibility of the government, and the integration of DRR with development programs, at the time before the disaster (pre-disaster), and choosing the action needed to be done to minimize the risk of disaster [6].

The principle of humanity has been manifested in disaster management, which are also one of the foundation, principles and objectives of disaster management in the Act Number 24, along with environmental sustainability, and science and technology. The humanitarian principles in the implementation of the economic functions of disaster management have required the world involvement and/or private sectors. Investment business will provide an increased capacity and ability to perform precision, speed and accuracy; chiefly conducting the emergency response as well as doing a search and rescue, emergency rescue and / or evacuation of disaster victims. Though, in the aftermath of this investment can be a reference in the rehabilitation and reconstruction program that are more better; considering of the dynamics of motion of the Earth and the latest extreme weather for sustainable development.

Local culture and/or work ethic can also afford an investment in giving the increasing of community resilience. For instance, on tsunami disaster in 2004, the Smong culture in the Simelue Island has demonstrated the power of culture in DRR. In the Smong culture conveyed through poetry chanting called Nandong has conveyed the message of wisdom symptoms marking the arrival of the tsunami disaster in the form of a huge wave of sea water to the plains. On 26 December 2004, only three persons were affected by Tsunami. Those poems are namely *Smong dumek-dumekmo* (Tsunami is your bathing water), *Linon uwak-uwakmo* (Earthquake is your swings), *Elai kedang-kedangmo* (Thunderstorm is your drums), and *Kilek sulu-sulu mo* (*Flash of light is your lights*).

### **DRR investment in the design system, equipment, and fulfillment of basic needs**

In the case of the design system, rescue equipment, an evacuation of victims are necessitating several consideration, namely; (1) Studying and pioneering the rescue and evacuation paths, (2) Promoting the search and rescue, and (3) Preparing the basic needs. This includes the provision of basic needs (a) the need for clean water and sanitation (b) Food, (c) Clothing, (d) Health services, (e) Psychosocial and (f) Shelter.

In understanding this case, as an example that researchers and practitioners should change the perspective, by giving attention and consideration, that the implementation cycle during the pre-disaster needs to be taken care, based on the experience of cases the implementation of emergency response and disaster. Thus, the lessening dependence on the government and society should be ongoing independent preparedness. This self-readiness has ability to direct a synergy between government, communities, and businesses; in preparing a strategic move into a better neighborhood build a sustainable manner.

### **Conclusion**

Disaster risk reduction is one of the investment, which needs to be done in the pre-disaster, and requiring a strategic planning; for investment management needs of humanity, and providing reinforcement planning in building a resilient region in a sustainable manner, as well as, connecting with vulnerability and capacity of communities, government and business.

### **Reference**

- [1] Alessandra Cozzolino, *Humanitarian Logistics : Cross-Sector Cooperation in Disaster Relief Management*, (2012) Springer Heidelberg New York Dordrecht London

- [2] Annon, Indonesia: Post-reconstruction Aceh – Leftover problems, Jakarta Post, 26 Dec 2009, akses 19.08.2014: <http://www.thejakartapost.com/news/2009/12/26/postreconstruction-aceh-leftover-problems.html>.
- [3] Krishna S. Pribadi, Muhammad Dirhamsyah, Bayu Novianto, "Long-Term Post-Tsunami Recovery in Aceh: Survey of Community Perspective on Recovery Priorities" (2010), *Dalam proceedings of the 5th AIWEST-DR*, Banda Aceh, Indonesia, 23-25 November, ISSN: 2086-3195.
- [4] Muhammad Dirhamsyah, "Long-term Strategy on Aceh Tsunami and Mitigation" (2009), *proceedings of the 4th AIWEST-DR*, Banda Aceh, Indonesia, 23-25 November, ISSN:2086-3195
- [5] City of Kobe, "Comprehensive Strategy for Recovery from Great Hanshin-Awaji Earthquake, March 2010.
- [6] The Act Number 24 of 2007 on the Disaster Management.

## Morphology of Spray Dried Red Pitaya Pigment Powders

<sup>1</sup>Ruri Aditya Sari, <sup>2</sup>Norziah Mohd. Hani, & <sup>3</sup>Kinanti Wijaya

<sup>1</sup>Agroecotechnology Division, Faculty of Agricultural,  
Universitas Pembangunan Panca Budi Medan, Indonesia  
ruri.adit@gmail.com, +6282277218080

<sup>2</sup>Food Technology Division, School of Industrial Technology,  
Univesiti Sains Malaysia  
norziah@usm.my, +604-6533888

<sup>3</sup>Building Technology, Faculty of Technic,  
Universitas Negeri Medan  
kinanti.w@gmail.com, +6281375727287

### Abstract

Betacyanin pigments from red pitaya fruit (*Hylocereus polyrhizus*) could be an alternative source of natural red colourant for food application. The extraction of betacyanin pigment was extracted from the flesh of red pitaya fruits grown locally in Malaysia by using water as the extracting solvents. Spray-drying technique was also performed on the pigment extracts to increase the stability and shelf life of the pigment extracts obtained. Two types of maltodextrin with different DE's (10 DE and 25 DE) and mixtures (10 DE + 25 DE) were used as coating agents in the spray drying technique to give a total soluble solid (TSS) ranging from 20 % - 30 %. The objective of this study was to investigate the effect of different types of maltodextrin on the morphology of pigment powder. The morphology of the red pitaya pigment powders produced at drying temperatures (200 °C) in the spray drying technique were characterized by using Scanning Electron Microscopy. The morphology of pigment powders upon storage (0 - 6 months) with the ascorbic acid (0.1 % and 1.0 % w/w, respectively) addition was also investigated. Maltodextrin 25 DE had smoother outer structures when compared to 10 DE. The SEM micrographs showed that 10 DE samples had more surface indentations and cracks in wall system.

**Keywords:** pigment, red pitaya, spray dry, SEM

### 1 Introduction

Most natural pigments including betacyanins are easily affected by temperature, oxygen, light and water activity. Stability is an important aspect to consider when using of natural pigments as colourants in foods. The stabilization of betacyanin could be improved using microencapsulation technologies, such as spray drying [1]. Microencapsulation is described as a technique wherein a sensitive ingredient is encapsulated to produce microcapsules, thereby protecting it from oxygen, water or other conditions to improve its stability. In addition, microencapsulation can convert liquids into powders, which are easy to handle [2]. Spray drying is a widely used process to produce fruit juices powders and pigment powders. This process resulted with a good quality, low water activity and easier transport and storage of the powders. The physicochemical properties of powders produced by spray drying depend on viscosity of liquid feed, flow rate, air drying temperature, pressure and type of atomizer. Different types of maltodextrin as coating materials could provide different protection against oxidation since they create different wall thicknesses and densities of the spray dried powder particles.

Scanning Electron Microscopy (SEM) analysis can be to evaluate the encapsulating ability of various polymers [3]. It's important to analyze the morphology of the pigment powder, because it can show the surface of the coating agent. From previous study, found that the surface of powder gave effect to the stability of the pigment powder.

In this study, red pitaya pigment extract was subjected to spray drying process to produce pitaya pigment powders using 2 different types maltodextrins (10 DE and 25 DE) and maltodextrin mixtures (10 DE + 25 DE) concentration as coating materials at several of total soluble solid (TSS) concentration. The spray dried pitaya pigment powder obtained was examined for their morphology characteristic.



## 2 Materials and Methods

Red pitaya fruits (*H. Polyrrhizus*) were obtained from plantation in Johor, Malaysia. Fresh fruits samples were cut, peels removed and kept frozen at -18 °C for further analysis. Maltodextrin M100 (10DE) and M250 (25DE) were kindly provided by Grain Processing Corporation (USA). Maltodextrin was used as the wall materials for encapsulating red pitaya pigment.

### 2.1 Production of Red Pitaya Pigment Powder

The pigment extract thoroughly mixed with the coating material using an Ultraturrax IKA Labortechnik and stirred to homogeneity for the feed mixture. Three different mixtures of maltodextrin were formulated as the coating materials, there are maltodextrin 10 DE, maltodextrin 25 DE and maltodextrin mixture (10 DE and 25 DE, 1:2 ratio). Maltodextrin was added to the pigment extract to obtain the TSS content of 20 - 30 % (w/w). High TSS obtained by increasing amount of maltodextrin. Solid contents were measured using a PAL-1 digital refractometer (Atago Co., Ltd., Japan). The feed mixture was spray dried in a Büchi Mini Spray Dryer (B290, Flawil, Switzerland) at 200 °C inlet air temperature and 98 °C outlet air temperature, feed rate of 0.8 l/h (40 % maximum pump speed). The morphology of pigment powders (Mixture 10 DE and 25 DE) upon storage with the ascorbic acid (0.1 % and 1.0 % w/w, respectively) addition was also investigated.

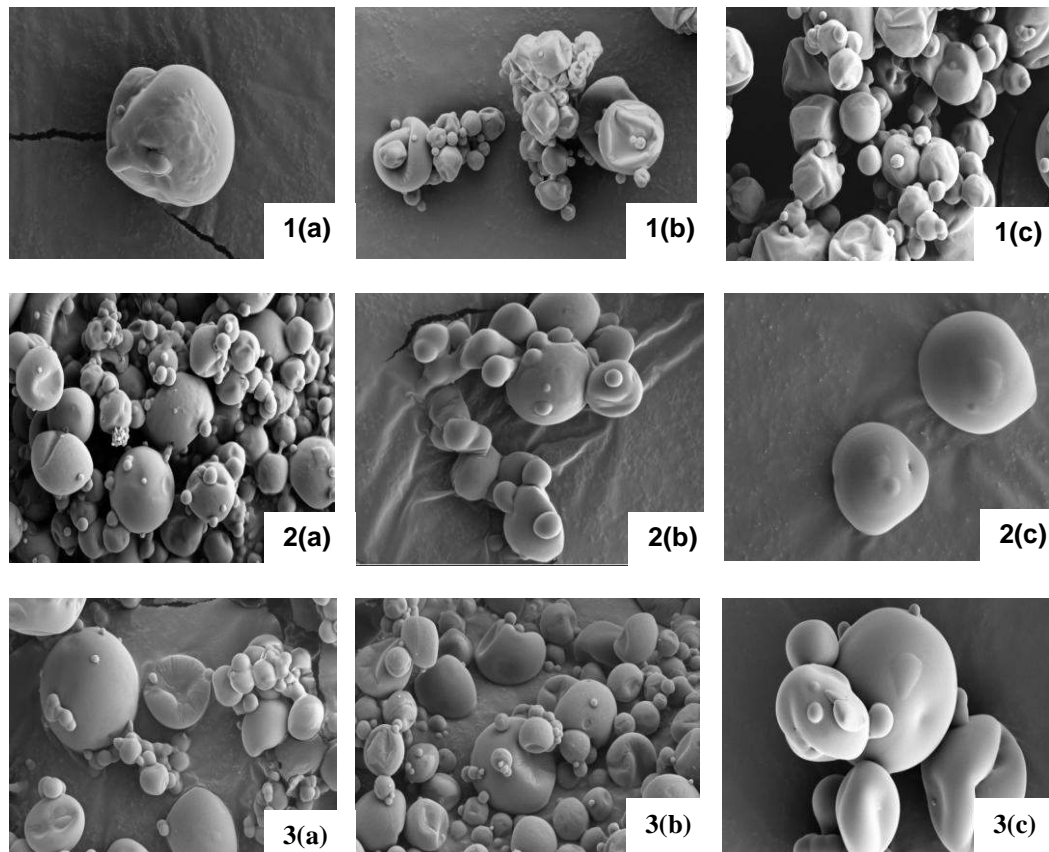
### 2.2 Scanning Electron Microscopy (SEM) Analysis

Scanning electron microscopy (SEM) images were obtained for all the pitaya pigment powders to examine pigment powder were using a Scanning electron microscopy Leo Supra 50vp (Oberkokhen, Germany). Samples were fixed onto SEM stubs using a two aside adhesive tape. The surface was sputtered for 120 seconds and coated with a thin layer of gold. Representative photographs were taken at 3000 x magnification and operated at 5 kV.

## 3 Results and Discussions

Scanning Electron Microscopy (SEM) analysis can be to evaluate the encapsulating ability of various polymers (Moshe et al., 1985). Figure 1 shows SEM micrographs of spray dried pitaya pigment powder produced. The spray dried pitaya pigment powder or microcapsules showed spherical shapes with smooth and some shrinkage surfaces. Samples with maltodextrin 25 DE had smoother outer structures when compared to samples with 10 DE. The SEM micrographs showed that 10 DE samples had more surface indentations and cracks in wall system. Low molecular weight sugars may act as a plasticizer preventing shrinkage of the surface during drying [2]. With maltodextrin mixtures (10 DE + 25 DE), smoother surface microcapsules were obtained and the microstructure of microcapsules seemed to improve. The smooth outer surfaces of these samples were similar to those samples with 25 DE. Samples with 10 DE especially at 30 % TSS had many deep dents compared to the others. For the samples with mixtures (10 DE + 25 DE) increasing TSS content to 25 % gave better outer structure and the surfaces of microcapsules were smoother and more uniform. It was found that all the pitaya pigment powder with various coating materials at 30 % TSS was irregular in shape and also sticky. The outer surfaces of the spray dried microcapsules were characterized by the presence of dents. It is concluded with increasing TSS, the structure of betacyanin powder becomes sticky, more surface indentations and cracks in wall system. According to Kalab [4], the dents formed in the spray dried powder are due to shrinkage of the particles during drying and cooling due to the high concentration of maltodextrin used.





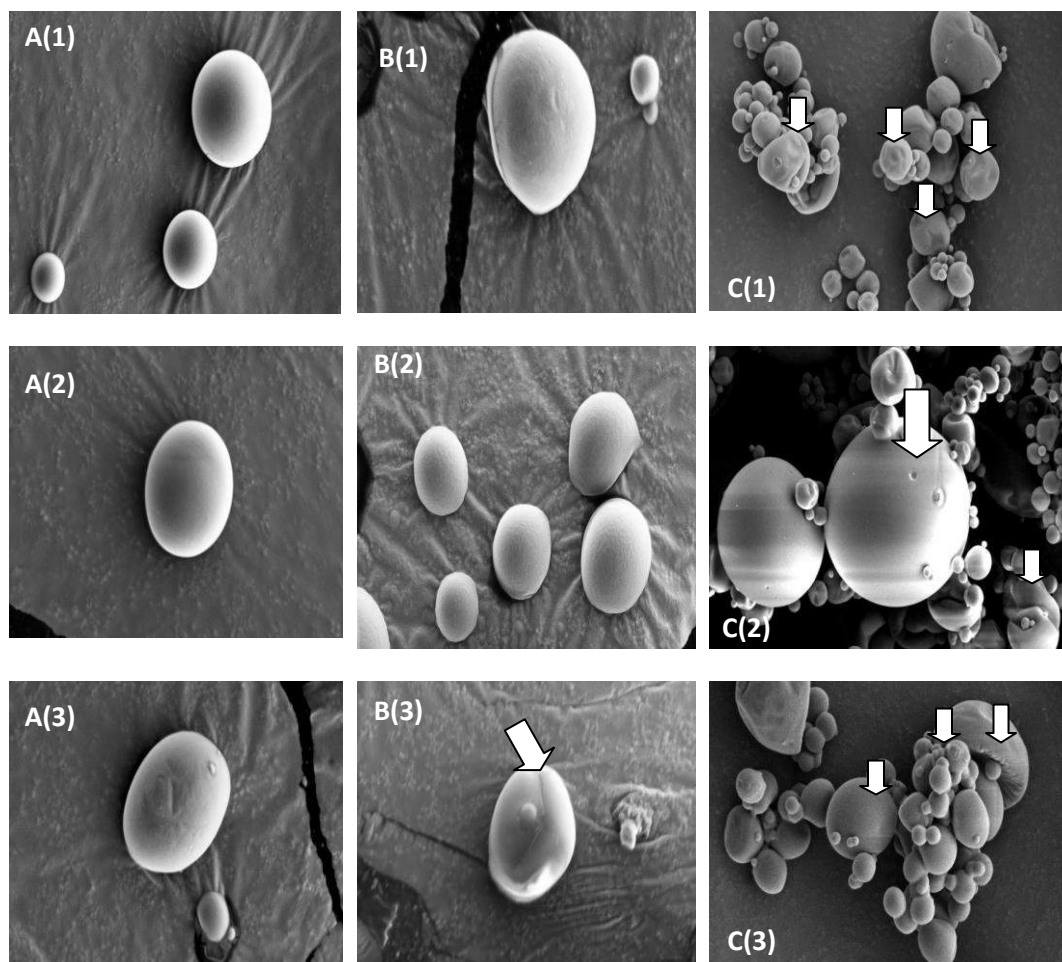
**Figure 1.** SEM micrographs of spray dried pitaya pigment powders. Pitaya pigment powder samples: with (1) 10 DE; (2) 25 DE; (3) the mixture (10 DE + 25 DE) at ratio 1:2. TSS content: (a) 20 % TSS; (b) 25 % TSS and (c) 30 % TSS. The magnification of all micrograph was 3000x (2 $\mu$ m |—|).


The use of low and intermediate inlet temperature will caused pliable and collapsed physical characteristics of the outer surface of microcapsules, while the use of high inlet temperature resulted in rigid and porous physical characteristics of the outer surface [5]. With respect to powder morphology, increasing temperature resulted in a greater number of particles with smooth surface with larger sizes, due to the higher drying rate [6].

SEM analysis was performed to observe the physical changes of betacyanin powder upon storage (Figure 2). Based on SEM, it was found that there were differences in the shape of microcapsule obtained between control samples (CoSP) and samples with 0.1 % ascorbic acid. It was observed that control samples show smooth oval shapes microcapsules upon storage period of 0 and 3 months. However, after 6 months of storage, control samples were observed to have indentation with irregular shape microcapsules and showing more signs of shrinkage. Smooth shapes microcapsule was observed in microcapsules of other pigments such as *Opuntia ficus-indica* [7], *Amaranthus* [8] and  $\beta$ -carotene [2].

This degradation may be caused by the collapse of the particle surface, thus more dented and cracks on the surface appeared. Samples with addition of 0.1 % and 1.0 % ascorbic acid appeared to have smooth surfaces through the storage period of 3 months. It was not occurred until storage of 6 months, those microcapsules with 0.1 % and 1.0 % ascorbic acid that tiny cracks or indentation are beginning to appear with more pronounced indentation. These changes may be related to the ability of powder to retain pigment. The degradation of pigment may be caused by shape of particle changes which allow oxygen entered and increasing the oxygen solubility.

In addition, control samples (CoSP) and samples with 1.0 % ascorbic acid microcapsules were found to be sticky and clumping together after 6 months storage. This may indicate pigment degradation. The formation of dented surfaces of the microcapsules was attributed to the shrinkage of the particles during the processing and storing [7].



**Figure 2.** Micrographs of spray dried pitaya pigment powders stored at 25 °C, in the dark condition.  
Pitaya pigment powder samples: (1) Control (CoSP); (2) 0.1 % ascorbic acid (0.1 % VC); (3), 1.0 % ascorbic acid (1.0 % VC).  
Storage period: (A) 0 month; (B) 3months; (C) 6 months;  
Magnification at 3000 x (2µm ).

## 4 Conclusions

The different coating materials gave effect to the surface of the powder. High TSS content will show sticky surface. The addition of 1.0 % ascorbic acid was found to be sticky and clumping together after 6 months storage. Spray dried pitaya pigment powder with addition 0.1 % ascorbic acid showed better surface of coating agent compared to the 1.0% ascorbic acid.

## 5 References

- Desai, K.G.H., & Park, H.J. (2005). Recent development in microencapsulation of food ingredients. *Drying Technology*, 23, 1361-1394.
- Loksuwan, J. (2007). Characteristics of microencapsulated  $\beta$ -carotene formed by spray drying with modified tapioca starch, native tapioca starch and maltodextrin. *Food Hydrocolloids*, 21, 928-935.
- Moshe, R., Isaiah, J.K., & Yeshayahu T. (1985). A Scanning Electron Microscopy study of microencapsulation. *Journal of Food Science*, 50, 139-144.
- Kalab, M. (1979). Scanning Electron Microscopy of Dairy Products: an overview. *Scanning Electron Microscopy III*, 261.

- Allamilla-Beltrán, L., Chanona-Pérez, J.J., Jiménez-Aparicio, A.R., & Gutiérrez-López, G.F. (2005). Description of morphological changes of particles along spray drying. *Journal of Food Engineering* 67 (1–2), 179–184.
- Tonon, R.V., Brabet, C., & Hubinger, M.D. (2008). Influence of process conditions on the physicochemical properties of açai (*Euterpe oleraceae* Mart.) powder produced by spray drying. *Journal of Food Engineering*, 88, 411-418.
- Saézn, C., Tapia, S., Chávez, & Robert, P. (2009). Microencapsulation by spray drying of bioactive compounds from cactus pear (*Opuntia ficus-indica*). *Food Chemistry*, 114(2), 616-622.
- Cai, Y.Z., & Corke, H. (2000). Production and properties of spray-dried *Amaranthus* betacyanin pigments. *Journal of Food Science*, 65(6), 1248-1252.

# Evaluation of Technology Readiness-Acceptance in Operation of Project Management Services

Rorim Panday

Bhayangkara Jaya University, Management, Jakarta, Indonesia,  
indripan@gmail.com, +62 8161864272

## Abstract.

Applying of ICT in the project management services such as reporting, administration and communication, make more effective and efficient operations. However, the opposite can happen. Whereas existing Internet, new software with hardware supports. Suspected, the technology readiness of implementing ICT projects have not been as expected. This research was carried out on PT. Pembangunan Perumahan projects, as one of the best contractors in Indonesia, has many projects throughout Indonesia, to evaluate the level of technological readiness and acceptance of implementing project management. This research survey done in January 2015, using a questionnaires developed by Parasuraman and Davis, applying the Technology Readiness Acceptance Model (TRAM). The number of respondents were 46 people, consists of project managers, deputy project managers and project management staff. Processing and data analysis using path analysis in AMOS 18. The results of this study indicate that the Technology readiness no effect on perceived usefulness; optimism and discomfort were positive significant effect on the perceived ease of use, Insecurity negatively affect the perceived ease of use, while innovativeness did not affect the perceived ease of use. Furthermore, perceived ease of use positive effect on perceived usefulness and actual use. Perceived usefulness has no effect on the actual use.

**Keywords:** *project management; technology readiness; technology acceptance; technology readiness acceptance model*

## 1 Introduction

Advances in technology plays an important role in the various activities of human beings, such as business activities, trades, industries, social, cultural, and not least in the field of education. Currently ICT and IT, has been used in every activity of the organization, either partially or as a whole. (Panday & John, 2015). ICT and IT has become an even more prominent in the current human activities. ICT is part of the system of input-process-output of an operational system of an activity / organization. By using ICT is expected to improve the effectiveness and efficiency. With the ICT system, it is expected that the results are more accurate, delivered quickly and satisfactorily (Panday, 2015). ICT is also used to manage the project. Many project can be done by human, physical project such as building, tol road, dam, airport, harbour, town etc, and non physical project such as education, training, health, culture etc. So that, project is the activities to build or making something that give benefit for organization or people, which use limited budget, time and refered to certain specification (Kerzner, 1998; Meredith, Jack.R and Mantel, Samuel J., 1995; Nicholas, John M, 1990). To accomplish the project, it is needed project management knowledge. Project management as the application of knowledge, skills, tools and techniques to project activities in order to meet or exceed stakeholder needs and expectations from a project (PMBOK Guide, 1996).

There are some Operation management in project, such as project initiation, project planning, project implementation, project controlling and project closing (PMBOK Guide, 1996). To support those operation management, will be better use ICT. Using ICT in the operation of project cover: data management, (personel, materials, equipments), data processing( drawing, engineering data, statistics), data presentation (project report for all level of management), and data delivery (data deliver to many project stake holder). By using ICT, it hope the activities of project Manager will effective and efficient. So that the goals project can be achieved. However, the implementation of ICT is still depend on the person operated the ICT, may be deped on on their skill in operate the instruments of ICT, technology readiness and thecnology acceptance of the person. Therefore, it is very interesting to rereveal the technology readiness dan technology acceptance in project

management, its their effect and relationship. For that aims, the research done at PT. Pembangunan Perumahan projects, in Indonesia.

PT.Pembangunan Perumahan (PT.PP) (PP construction & Investment, 2015) is one of the best contractor in Indonesia, founded 1953, with the vision “ to be a leader in construction and invesment company in Indonesia, which internationally competitive”. Many project have bulit by PT.PP through out indonesia, executed by ten branch in indonesia and Timor Leste.. Currently Business Activity of PT.PP (PP Construction & Investment, 2015) are:

1. Construction Services: as PT PP (Persero) is dealing with Public Construction Services as the core business which includes : High-Rise Buildings, Roads and Bridges, Dams and Irrigations, Hydro Electric and Coal Fire Power Plants, etc. Those Constructions are not merely great value to the Society, but also monumental and landmarks to the Nation.
2. Property and Realty : PT PP (Persero) undertakes a business development in the area of Property and Realty by developing Idle Assets of the Company and engages in strategic partnership to create a Property development business such as : Apartments, Hotels, Offices, Malls, Trade Centers and Housings for sale.
3. PP Equipment: Construction equipment has a very important role in the construction industry. Availability of good construction equipment can support the realization of good project management, construction quality results, and ultimately will lead to the results of sturdy construction, reliable, and competitive
4. Engineering, Procurement & Construction (EPC): Business development in EPC is designed under certain business model that considers market segment, competitive strategy, value chain, revenue, capital, and growth strategy structure. The Company has implemented EPC business roadmap with focus and objectives on energy, oil and gas, mining as well as manufacture sectors.
5. Investment Segment on Infrastructure : Investment on infrastructure sector that had been performed is 12.5% participation with PT Citra Waspphutowa. The investment was realized in Depok - Antasari toll road project construction and management covering 22.8 km.
6. PP Precast : The Company implements business on Precast sector, where precast system has been widely applied in Indonesia. On precast system, all of building component can be fabricated and later installed on the field. Component making process can be performed with adequate quality control. The business prospect is catered by the Company within business expansion establishing plants for precast sector in Cilegon, West Java.

To run those activities, PT.PP implemented the business strategy such as: efficiency, R & D Innovation, Excellent HRD, Good Corporate Governance, Risk management, and Healthy Financial (PP construction & investment, 2015). To handle those project, PT.PP formed team project management in each project location. Most of the project manager of PT.PP are still young, but they have equipped the competency before placed in the project, such as project management skill. In operation management, PT.PP has implemented the ICT to support the services engineering of their projects, although ICT system not fully integrated right now. ICT implementation is already underway for the management of human resources, finance and accounting and monitoring vendors. In average the young project manager are very stiking ICT.The future they plan to make the integrated ICT system as IT solution. So far, the project manager did not have handicap in using ICT. It is very interesting in that condition, to see and evaluate the level of readines and level of acceptance and it relationship in using ICT in project management of the PT.PP projects.

## **2 Review of Literature**

This research is combine of two theories, those are the theory of technology readiness which has introduced by Parasuraman dan the theory of technology acceptance which developed by Parasuraman and Davis, result the technology readiness-Acceptance model (TRAM).

Technology readines (TR) is refers to “people’s propensity to embrace and use new technologies to accomplish goals in home life and at work” (Parasuraman, 2000, p. 308), which can be viewed resulting from four personality dimensions: optimism, innovativeness, discomfort, and insecurity. According to Parasuraman (2000) these personality dimensions affect people’s tendency to embrace and use new technologies. In this respect optimism and innovativeness function as mental enablers, while discomfort and insecurity function as mental inhibitors to accept new technologies. TR is a

combination of positive and negative technology-related beliefs. These beliefs are assumed to vary among individuals. Collectively, these coexisting beliefs determine a person's predisposition to interact with new technology (Parasuraman & Colby 2001). The four dimensions of TR are: (Parasuraman, 2000).

- Optimism is defined as “a positive view of technology and a belief that offers people increased control, flexibility, and efficiency in their lives” (Parasuraman & Colby, 2001, p. 34). It generally captures positive feelings about technology.
- Innovativeness is defined as “a tendency to be a technology pioneer and thought leader” (Parasuraman & Colby 2001, p. 36). This dimension generally measures to what degree individuals perceive themselves as forefront.
- Discomfort is defined as “a perceived lack of control over technology and a feeling of being overwhelmed by it” (Parasuraman & Colby 2001, p. 41). This dimension generally measures the fear and concerns people experience when confronted with technology.
- Insecurity is defined as “distrust of technology and scepticism about its ability to work properly” (Parasuraman & Colby, 2001, p. 44). This dimension focuses on concerns people may have in face of technology-based transactions.

Optimism and innovativeness are drivers of technology readiness. A high score on these dimensions will increase overall technology readiness. Discomfort and insecurity, on the other hand, are inhibitors of technology readiness. Thus, a high score on these dimensions will reduce overall technology readiness (Parasuraman, 2000). Results show that the four dimensions are fairly independent, each of them making a unique contribution to an individual's technology readiness (Parasuraman & Colby, 2001).

Another theory used in this study is the technology acceptance model (TAM), which introduced by Davis (1989, p. 320); In TAM there are two central determinants: *Perceived usefulness*, which refers to “the degree to which a person believes that using a particular system would enhance his or her job performance” (Davis, 1989, p. 320); and *perceived ease of use*, which refers to “the degree to which a person believes that using a particular system would be free of effort” (Davis, 1989, p. 320). TAM was designed specifically to explain computer usage behaviour. It is an adaptation of Fishbein and Azjen's (1975) theory of reasoned action (TRA), which has been successful in predicting and explaining behaviour in general (Malhotra & Galletta, 1999; Yi & Hwang, 2003).

Following the theoretical basis of TRA these perceived characteristics are expected to influence intentions to use a system, which in turn influence actual system usage (Davis et al., 1989). Furthermore, perceived ease of use is hypothesized to influence perceived usefulness. This hypothesis follows from the logic that improvements in ease of use of a system contribute to increased usefulness due to saved effort (Davis et al., 1989).

The TAM has received considerable support over the years. It has been validated over a wide range of systems, and perceived usefulness and perceived ease of use have proven to be reliable and valid cognitive dimensions (Burton-Jones & Hubona, 2006; King & He, 2006).

In this study used TRI integrated with TAM, which “people's propensity to embrace and use new technologies to accomplish goals in home life and at work” will predict to technology acceptance, and the next will influence to behavior intention which represent by actual use. The integrated model was named as TRAM (Technology Readiness-Acceptance Model). This integrated model has been used by several researcher such as Lin, Shih, Sher, and Wang (2005), and Walczuch, Lemmink, and Streukens (2007) while linkages between perceived usefulness, perceived ease of use, and actual use of technology are well established by Davis (1989), Venkatesh & Davis (2000) and ; Schepers & Wetzels (2007). Another researcher also use TRAM are :

1. Murat Esen, Nihat Erdogmu, (2014), do their research about the effects of technology readiness on technology acceptance in e-HRM: mediating role of perceived usefulness
2. Kuang-Ming Kuo, Chung-Feng Liu and Chen-Chung Ma(2013), do their research to investigate the effect of nurses' technology readiness on the acceptance of mobile electronic medical record systems.
3. Mimin Nur Aisyah, Mahendra Adhi Nugroho, Endra Murti Sagoro (2013), do their research about the effect of technology readiness on technology acceptance at UMKM in Yogyakarta.
4. Anders Husa, Magnus Kvale (2009), do their research about the TRAM framework in a social media context by measuring attitudes towards consumer-company interaction, as a study of Norwegian social media users.

5. Rita Walczuch, Jos Lemmink , Sandra Streukens (2006), do their research aboutn the effect of service employees technology readiness on technology acceptance.
6. Issham Ismail, Siti F Bokhare, Siti N Azizan, Nizuwan Azman (2013), do their research about teaching via mobile phone, asa a case study on Malaysian teachers' Technology Acceptance and Readiness
7. Jui-yen Yen. (2014), do the research of perspectives from the TRAM model on adopting e-Learning, as an analysis of the chain and franchise industry in Taiwan.
8. Nadine Guhr, Tai Loi, Rouven Wiegard, and Michael H. Breitner. (2013), do their research of technology readiness in Customers' perception and acceptance of mobile payment as an empirical study in Finland, Germany, the USA and Japan.

To see the related research, the report study in this paper is implementation of TRAM in using ICT on project management activities, which is different object from previous studies.

### 3 Methodology

This study aims to evaluate the technology readiness on technology acceptance of project manager in application ICT in project management at PT. Pembangunan Perumahan projects, and to see their relationship in TRAM (Technology Readiness-Acceptance Model). This study was a quantitative study using a questionnaire that was developed by Parasuraman for TRI and Davis for TAM. The questionnaire was translated into Indonesian, and given to the respondents to anyone who is concerned and using ICT system consisting of project manager, vice project manager and project management staff. As a simply, those respondents defined as project managers.

Technology readiness was assessed through the use of the 36-item Technology Readiness Index (TRI) scale developed by Parasuraman (2000). The TRI is a Likert type scale with responses ranging from —Strongly Agree (5) to —Strongly Disagree (1). The TRI helps explains how and why the project managers adopt technology. The TRI does this by looking at both forces that attract and repel individuals away from new technology.

Technology acceptance was assessed through the use of 6 item for perceived usefulness, 6 item for perceived ease of use dan 1 question for actual use, which asked the frequency in using ICT.

Of the 100 questionnaires distributed, obtained 45 completed questionnaires as well. After data obtained, tested the validity and reliability, using Pearson correlation and Cronbach coefficient, processing are performed using SPSS version 11.5. For to the TRAM, used pathway analysis, conducted by AMOS 18. The figure of path analysis model is as follows:

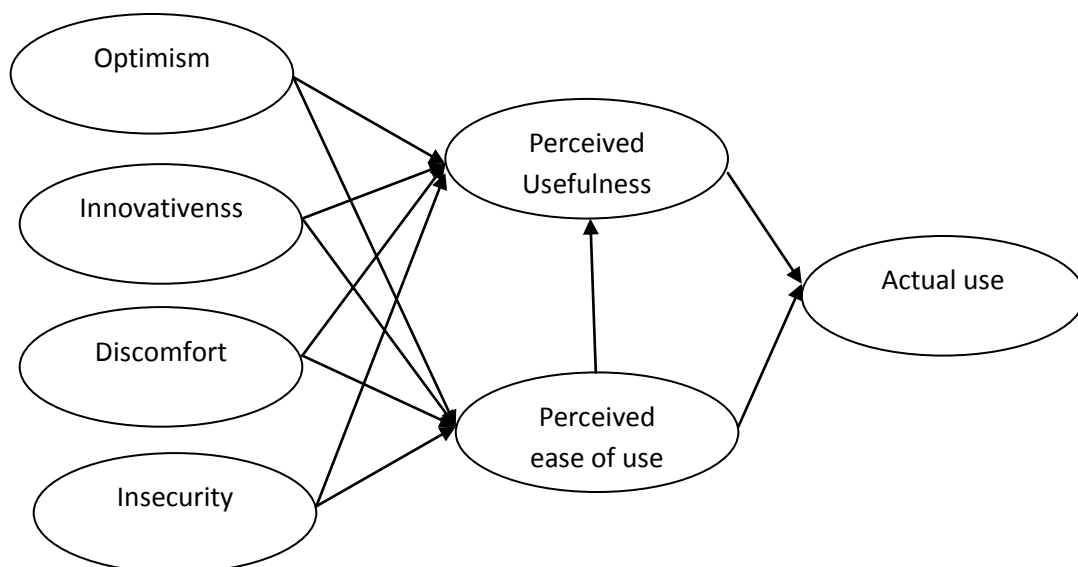


Figure 1. The integrated model (TRAM) with hypothesized relations among study variables.

According to Parasuraman & Colby (2001) and Tsikriktsis(2004), the optimistic and innovative people to technology as enablers that have positive effects, in general are thought to hold positive attitudes toward new technology and technology use. Therefore, researcher hypothesized that:

H1. Optimism is positively related to perceived usefulness.

H2. Innovativeness is positively related to perceived usefulness.

H3. Optimism is positively related to perceived ease of use.

H4. Innovativeness is positively related to perceived ease of use.

Discomfort, is not expected to have a negative impact on perceived usefulness. One would expect people to see the main value of a system regardless of how they handle it. Still, discomfort is expected to affect perceived ease of use. A system that is not manageable is more likely to be a non user-friendly system. Thus, for that hypothesize:

H5. Discomfort is not significantly related to perceived usefulness.

H6. Discomfort is negatively related to perceived ease of use.

Feelings of insecurity related to technology are on the other hand associated with ambiguity and low usage (Parasuraman & Colby, 2001; Tsikriktsis, 2004). Based on prior research, assume that insecurity predicts lower levels of perceived usefulness and perceived ease of use. For that hypothesize:

H7. Insecurity is negatively related to perceived usefulness.

H8. Insecurity is negatively related to perceived ease of use.

The effects of perceived ease of use contributes to perceived usefulness have done by (King & He, 2006; Lin et al., 2005; McFarland & Hamilton, 2004; Schepers & Wetzels, 2007; Venkatesh, 2000; Yang & Yoo, 2004). Based on the assumptions that some user-friendly applications could be perceived as useful, but not all useful applications are user-friendly. Thus, researcher hypothesize:

H9. Perceived ease of use is positively related to perceived usefulness.

According to Davis (1989) the main contributor to actual use of a new technology is its perceived usefulness. Hence, people mostly adopt new technologies based on their functions, rather than based on practically. Users are, for instance, willing to adopt a difficult system if it captures a critical function. However, in practical terms, about 90% of research done on TAM also shows direct effects of perceived ease of use on actual use (Schepers & Wetzels, 2007). Thus, researcher hypothesize:

H10. Perceived usefulness is positively related to actual use.

H11. Perceived ease of use is positively related to actual use.

## 4 Result and Discussions

Before to continue with the analysis of TRAM, first shall be explained the validity and reliability of data which have collected using questionnaires. The results of validity and reliability test shown at table-1 for technology readiness variables, dan table-2 for technology acceptance variables. As we see, the pearson correlation of each indicators of technology readiness variables have significant at level 0,01 and while, the alpha cronbach of each dimension of technology readiness indicate value more than 0,6. Based on that testing, the conclusion of the data of technology readiness are valid and reliable.

Table-1 Result of validity and Reliability test of Technology Readiness Variables

OPTIMISM	Pearson Correlation	INNOV	Pearson Correlation	DISCOM	Pearson Correlation	INSEC	Pearson Correlation
OPT1	,493(**)	INV1	,379(**)	DISC1	,642(**)	INSC1	,530(**)
OP2	,457(**)	INV2	,265	DISC2	,732(**)	INSC2	,570(**)
OP3	,538(**)	INV3	,742(**)	DISC3	,697(**)	INCS3	,456(**)
OPT4	,576(**)	INV4	,707(**)	DISC4	,513(**)	INSC4	,654(**)
OPT5	,499(**)	INV5	,584(**)	DISC5	,263	INSC5	,754(**)
OPT6	,636(**)	INV6	,734(**)	DISC6	,459(**)	INSC6	,678(**)
OPT7	,607(**)	INV7	,696(**)	DISC7	,411(**)	INSC7	,697(**)
OPT8	,617(**)			DISC8	,610(**)	INSC8	,625(**)
OPT9	,629(**)			DISC9	,783(**)	INSC9	,579(**)
OPT10	,398(**)			DISC10	,620(**)		
Alpha =	,7230	Alpha =	,6856	Alpha =	,7765	Alpha =	,7929

\*\* Correlation is significant at the 0.01 level (2-tailed).

\* Correlation is significant at the 0.05 level (2-tailed).



Also, for technology acceptance variables, the value of Pearson correlation of each indicators of technology acceptance have significant at the level of 0,01. The alpha cronbach for perceived usefulness and perceived ease of use indicate value greater than 0,6. Therefore, the data for technology acceptance are valid and reliable.

Table-2 Result of validity and Reliability test of Technology acceptance Variables

P_USEFUL <sup>1</sup>	Pearson Correlation	P_EASE <sup>2</sup>	Pearson Correlation
PU1	,831(**)	PEOU1	,839(**)
PU2	,932(**)	PEOU2	,736(**)
PU3	,963(**)	PEOU3	,754(**)
PU4	,923(**)	PEOU4	-,290
PU5	,884(**)	PEOU5	,827(**)
PU6	,943(**)	PEOU6	,784(**)
Alpha =	,9580	Alpha =	,6776

\*\* Correlation is significant at the 0.01 level (2-tailed).

\* Correlation is significant at the 0.05 level (2-tailed).

1.P\_USEFUL= Perceived usefulness

2. P\_EASE= Percveived ease of use

Next, will be reported decriptive analysis of each variables in the TRAM. In Table 3, the respondents, indicating the nature of optimism and innovativeness are quite high, indicating by the value of each indicators > 2.5 and also the average value > 2.5, so they have the mental enabler quite high in using ICT at project management.

Table-3 Average value of Optimism and Innovativeness dimension

Descriptive Statistics	Mean	Std. Deviation	Descriptive Statistics	Mean	Std. Deviation
OPT1	3,891	0,795	INV1	3,370	0,679
OP2	3,848	0,631	INV2	3,239	0,766
OP3	4,000	0,730	INV3	3,283	0,750
OPT4	3,804	0,719	INV4	3,435	0,720
OPT5	3,913	0,661	INV5	3,935	0,574
OPT6	4,370	0,488	INV6	3,565	0,886
OPT7	3,370	0,711	INV7	3,261	0,801
OPT8	4,239	0,673	Jumlah	24,087	
OPT9	4,196	0,619	Rata-rata	3,441	
OPT10	3,761	0,794			
Jumlah	39,391				
Rata-rata	3,939				

While the average value of discomfort and Insecurity at the table-4, can be said is also quite high, indicating by the value of each indicators > 2.5, and also the the average value > 2.5, so they have a quite high inhibitor properties in using ICT at project management. People that have high readiness should have lower inhibitors dimensions. In this case the high inhibitor will reduce the readiness of tecnology. Thus their technology readiness not too high / good in implementaing ICT in project management at their projects.

Table-4 Average value of Discomfort and Insecurity dimension

Descriptive Statistics	Mean	Std. Deviation	Descriptive Statistics	Mean	Std. Deviation
DISC1	2,435	0,886	INSC1	3,543	1,069
DISC2	2,587	1,087	INSC2	4,152	0,894
DISC3	2,739	0,880	INCS3	2,478	0,913
DISC4	2,848	0,894	INSC4	3,435	0,935
DISC5	3,326	0,871	INSC5	3,261	0,953
DISC6	3,326	0,896	INSC6	3,065	0,854
DISC7	3,326	1,012	INSC7	3,152	0,894
DISC8	3,109	1,016	INSC8	3,283	0,911
DISC9	3,065	1,143	INSC9	3,848	0,842
DISC10	2,674	0,762			
Jumlah	29,435		Jumlah	30,217	
Rata-rata	2,435	0,886	Rata-rata	3,357	

The average value of perceived usefulness and perceived ease of use, present at table -5. For Perceived ease of use, with the average value of 3.467, meaning their beliefs for ease use of technology is quite high. The average value of Perceived usefulness is 4,337, quite high also, meaning they have a fairly high confidence that the use of ICT, will gives many useful. The value of actual Use at table-6 is 5,826, can be interpreted high, meaning that the frequency of their use of ICT is high frequent.. However, those variables will be tested in the TRAM. Further,the path analysis using AMOS 18. Figure-2 for regression estimate , figure-3 for standard value estimate and table-7 shows the results of the path analysis.

Table-5 Average value of Perceived usefulness and perceived ease of use

Descriptive Statistics	Mean	Std. Deviation	Descriptive Statistics	Mean	Std. Deviation
PU1	4,435	0,544	PEOU1	3,565	0,688
PU2	4,304	0,511	PEOU2	3,587	0,686
PU3	4,304	0,511	PEOU3	3,739	0,612
PU4	4,348	0,482	PEOU4	2,239	0,603
PU5	4,261	0,575	PEOU5	3,783	0,664
PU6	4,370	0,488	PEOU6	3,891	0,605
Jumlah	26,022		Jumlah	20,804	
Rata-rata	4,337		Rata-rata	3,467	

Table-6 Average value of Actual use

Descriptive Statistics	Mean	Std. Deviation
AC_U	5,826	0,973

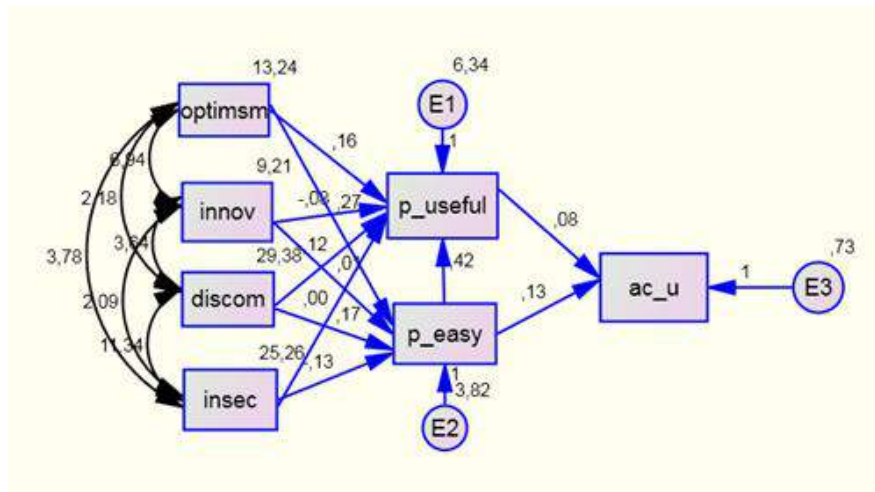


Figure-2 Result of Path model of TRAM

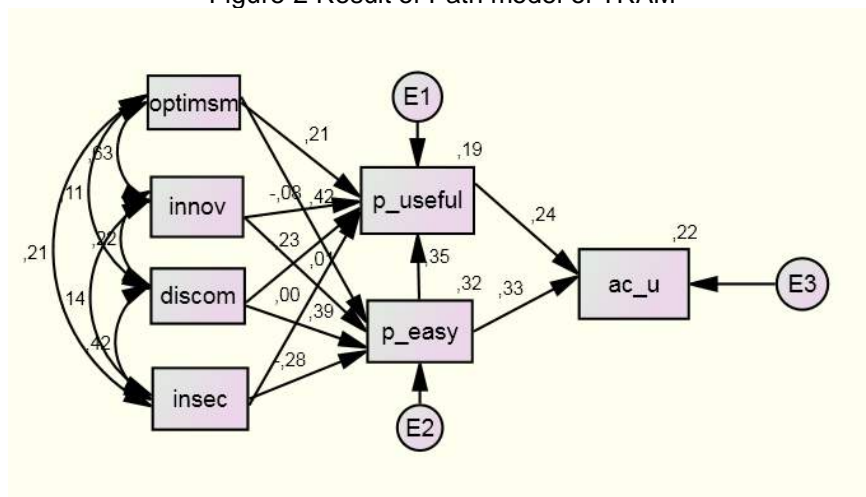


Figure-3 Result of Path model of TRAM in standard value

Table-7 Regression Weights: (Group number 1 - Default model)

			Estimate	S.E.	C.R.	P	Label	
p_ease	<---	innov	,009	,126	,073	,942	par_1	H4 not supported
p_ease	<---	discom	,172	,061	2,847	,004	par_2	H6 not supported
p_ease	<---	insec	-,132	,065	-2,034	,042	par_4	H8 supported
p_ease	<---	optimism	,275	,105	2,618	,009	par_7	H3 supported
p_useful	<---	innov	-,075	,163	-,463	,643	par_5	H2 not supported
p_useful	<---	optimism	,160	,145	1,102	,271	par_6	H1 not supported
p_useful	<---	discom	-,120	,085	-1,413	,158	par_8	H5 not supported
p_useful	<---	insec	-,001	,087	-,011	,991	par_9	H7 not supported
p_useful	<---	p_ease	,416	,192	2,168	,030	par_10	H9 supported
ac_u	<---	p_ease	,132	,057	2,319	,020	par_3	H11 supported
ac_u	<---	p_useful	,082	,048	1,705	,088	par_11	H10 not supported

Four dimensions of technology readiness i.e.: Optimism, Innovativeness, discomfort and Insecurity were not significant effect to perceived usefulness. It is indicated by probability value p greater than 0,05. The meaning of this condition, even though the value of perceived usefulness high (4,337), this beliefs of project managers were not influenced by individual character of technology readiness of project managers. There were not have relationship between TR and perceived usefulness. In this case H1, H2, H5 and H7 were not supported. Optimism gave the positif and significant effect to perceived ease of use, so this matter support the hypothesis H3. Innovativeness was not significant effect to perceived ease of use, because it has p value greater than 0,05. So, H4 was not supported.

Discomfort has positif effect to perceived ease of use and significant. But this case opposite to the hypothesis, so H6 was not supported. In this case project managers have discomfort quite high, and belief to perceived of use also quite high. If level of discomfort increase will effect increase to perceived ease of use. This can happen, even though they have high discomfort, they still belief that ease in using the ICT. Another dimension of TR, Insecurity has negatif effect to perceivf ease of use and significant. This matter was suported to the Hypothesis H8. It is means, if insecurity increase, the belief of perceived ease of use will decrease. Perceived ease of use has positif effect to perceived usefulness, so in this case H9 was supported. Perceived usefulness was not significant effet to actual use, so H10 was not soported. Perceived ease of use has positive effect to actual use, so it is support H11. Based on above analysis, there are four Hypothesis have supported by the case and seven hypothesis were not supported. By excluded the variables that not support the hypothesis from the first TRAM model, except discomfort to perceived ease of use, re-calculate the model use AMOS .18, resulting the final model as shown at figure-4 and figure-5.

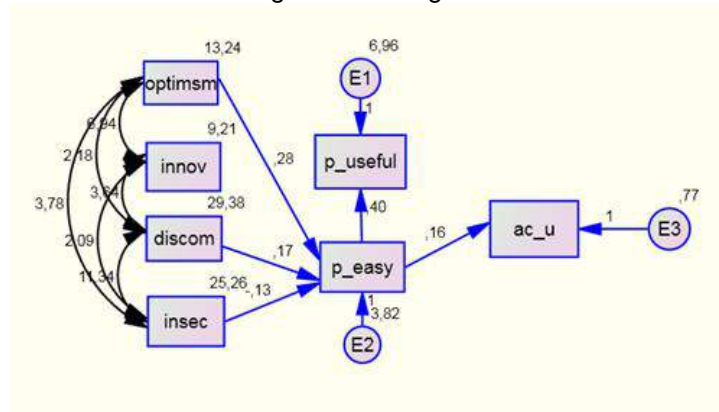


Figure-4. Final TRAM of Project managers with estimate value

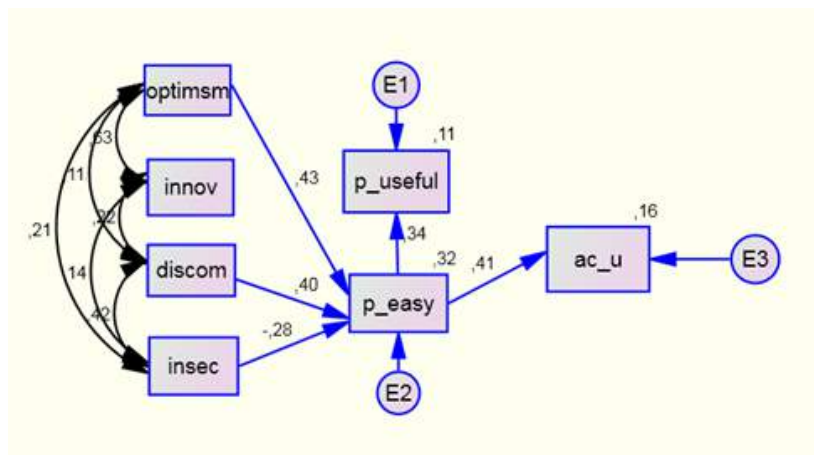


Figure-5. Final TRAM of Project managers with estimate value in standard value

Figure-4 and table-8 show path model of TRAM with the estimate value of path analysis, and figure-5 table-9 show path model of TRAM in the standard values of path analysis.

Table-8 Regression Weights

		Estimate	S.E.	C.R.	P	Label
p_ease	<--- discom	,173	,059	2,928	,003	par_1
p_ease	<--- insecurity	-,133	,065	-2,046	,041	par_3
p_ease	<--- optimism	,280	,082	3,414	***	par_4
ac_u	<--- p_ease	,165	,055	2,974	,003	par_2
p_useful	<--- p_ease	,397	,166	2,388	,017	par_5

The relations that shown in the figure and the table, indicate the significant relations; all proven by p value less than 0,05.

Table-9 Standardized Regression Weights

	Estimate
p_ease <--- discom	,397
p_ease <--- insec	-,282
p_ease <--- optimism	,430
ac_u <--- p_ease	,405
p_useful <--- p_ease	,335

Table 9, shows the effect of dimension of optimism, discomfort and insecurity to perceived ease of use, the effect of perceived ease of use to perceived usefulness and actual use. The Values in the table shows the effects.

Table-10 Squared Multiple Correlations

	Estimate
p_ease	,316
p_useful	,112
ac_u	,164

How the contribution the technology readiness and the technology acceptance, presented in table 10, indicate that the TRI variable which consist of optimism, discomfort and insecurity of 31.6% have explaining the Perceived ease of use, and of 11,2% have a role in explaining Perceived usefulness. Furthermore, perceived ease of use 16,4 % explaining to the Actual use. Next discussions, related to analyze total effects, direct and indirect effects, presented in table-11, table-12 and table-13.

Table-11 Standardized Total Effects

	optimism	insec	discom	p_ease
p_ease	,430	-,282	,397	,000
p_useful	,144	-,095	,133	,335
ac_u	,174	-,114	,161	,405

Analysis of total effect of each variables in table-11, with still consider to the result of hypothesis analysis above :

1. Optimism give the total effect on Perceived ease of use as 0,430, give the total effect on the perceived usefulness of 0,144 and to the actual use amounted to 0,174.
2. Insecurity give the total effect on the perceived ease of use of -0,282 and perceived usefulness of -0,095 , and it gives the total effect on the actual use of -0,114..
3. Discomfort give total effect on Perceived ease of use of 0.397, the perceived usefulness of 0.133 and the actual use of 0.161.
4. Perceived ease of use gives the total effect on the perceived usefulness of 0.325
5. Perceived ease of use gives the total effect on the actual use of 0.405.

Table-12 Standardized Direct Effects

	optimism	insec	discom	p_ease
p_ease	,430	-,282	,397	,000
p_useful	,000	,000	,000	,335
ac_u	,000	,000	,000	,405

Analysis of direct effect of each variables in table-12, also consider to the result of hypothesis analysis above :

1. Optimism give the direct effect on Perceived ease of use as 0,430,
2. Insecurity give the direct effect on the perceived ease of use of -0,282
3. Discomfort give direct effect on Perceived ease of use of 0.397.
4. Perceived ease of use gives the direct effect on the perceived usefulness of 0.325
5. Perceived ease of use gives the direct effect on the actual use of 0.405.

Table-13 Standardized Indirect Effects

	optimsm	insec	discom	p_ease
p_ease	,000	,000	,000	,000
p_useful	,144	-,095	,133	,000
ac_u	,174	-,114	,161	,000

Analysis of indirect effect of each variables in table-11, also consider to the result of hypothesis analysis above :

1. Optimism give the indirect effect on Perceived usefulness of 0,144 and to the actual use amounted to 0,174.
2. Insecurity give the indirect effect on the perceived usefulness of -0,095 , and it gives the indirect effect on the actual use of -0,114..
3. Discomfort give indirect effect on Perceived usefulness of 0.133 and the actual use of 0.161.

#### Goodness of fit test

Goodness of fit final model of TRAM of project manager, it shown by the indicator goodness of fit in the table-14.

Table-14 Goodness of fit model test

<b>Model Fit Summary</b>		
Default Model	GOF	Treshold value
Chi square statistics	10,834	As small as possible
p-value	0,371	>=0,05
CMIN/DF	1,083	<=2
GFI	,932	>=0,90
AGFI	,808	>=0,90
NFI	,859	Marginal fit
IFI	,987	>=0,90
TLI	,969	>=0,90
CFI	,985	>=0,90
RMSEA	,043	<=0,08

Based on (Wijaya, 2009; Yamin,Sofyan & Kurniawan Heri, 2009), all the value of Goodness of fit at the table-14, show that the final model of TRAM is the fit model. This final model is the reality the technology readiness and technology acceptance relationship and also their relation to the actual use in PT.PP project management. In this case, the final model have great difference with theoretical model. Those differences, more influence of the character of readiness and the belief of manager that really different with general character that have been defined in theoretical. In this case, only three dimensions of technology readiness effect to perceived ease of use, while perceived usefulness didn't influenced by technology readiness. In the portion of TAM, belief of perceived ease of use give it effect to perceived usefulness and actual use, while perceived usefulness didn't give it effect to the actual use. Final models show the real situation in the use of ICT that occurs in the TAM model project management of PT.PP. Therefore, it does not become a necessity to change the final models. In the final models, many deviations from the model theory. One thing that is very possible if the sample of the study added in future studies, which is expected to closed the theoretical model.

## 5 Conclusions

This study aims to reveal the level of technology readiness and technology acceptance and their relationship to the actual use in the nature of project management of PT. Pembangunan Perumahan. The results of this study indicate that the Technology readiness no effect on perceived usefulness; optimism and discomfort were positive significant effect on the perceived ease of use, Insecurity negatively affect the perceived ease of use, while innovativeness did not affect the perceived ease of use. Furthermore, perceived ease of use positive effect on perceived usefulness and actual use. Perceived usefulness has no effect on the actual use.

## 6 Acknowledgements

This research was made possible with the help and permission of the Head of the Human Resources Division of PT. Pembangunan Perumahan, Mr. Nugroho Agung, Mr. Hajar Seti Adji and my great daughter Adelia. Thank you to all of you.

## 7 References

- Anders Husa, Magnus Kvale (2009). "The TRAM Framework in a Social Media Context - Measuring Attitudes Towards Consumer-Company Interaction" A Study of Norwegian Social Media Users. Thesis Master of Science in Strategic Marketing Management. Oslo. Retrived from <http://andershusa.files.wordpress.com/2010/03/master-thesis-final.pdf>, 4 des 2014.
- Burton-Jones, A., & Hubona, G. S. (2006). The mediation of external variables in the technology acceptance model. *Information & Management*, 43, 706-717. doi:10.1016/j.im.2006.03.007
- Davis, F. D. (1989). Perceived usefulness, perceived ease of use, and user acceptance of information technology. *MIS Quarterly*, 13, 319-340. doi:10.2307/249008
- Davis, D., Bagozzi, R. P., & Warshaw, P. R. (1989). User acceptance of computer technology: A comparison of two theoretical models. *Management Science*, 35, 982-1003. doi:10.1287/mnsc.35.8.982
- Fishbein, M., & Ajzen, I. (1975). *Belief, attitude, intention, and behavior: An introduction to theory and research*. Reading, MA: Addison-Wesley.
- Issham Ismail, Siti F Bokhare, Siti N Azizan, Nizuwan Azman (2013). Teaching via Mobile Phone: a Case Study on Malaysian Teachers' Technology Acceptance and Readiness. School of Distance Education Universiti Sains Malaysia, Malaysia. *Journal of Educators Online*, v10 n1 Jan 2013. Retrived from: <http://eric.ed.gov/?id=EJ1004895>, 4 des 2014.
- Jui-yen Yen. (2014). Perspectives from the TRAM Model on Adopting e-Learning: An Analysis of the Chain and Franchise Industry in Taiwan. Retrived from : <http://140.131.112.6:8080/ir/bitstream/987654321/2032/2/TRAM%E6%A8%A1%E5%BC%8F%E8%A7%80%E9%BB%9E%E4%B8%8B%E8%87%BA%E7%81%A3%E9%80%A3%E9%8E%96%E5%8A%A0%E7%9B%9F%E7%94%A2%E6%A5%AD%E6%8E%A1%E7%94%A8%E6%95%B8%E4%BD%8D%E5%AD%B8%E7%BF%92%E4%B9%8B%E5%AF%A6%E8%AD%89%E5%88%86%E6%9E%90.pdf>. 25januari 2015,
- Kerzner, Harold (1998). *Project Management, a System Approach to Planning, Scheduling and Controlling*. John Willey & Sons, Inc. Canada. (page 2-3)
- King, W. R., & He, J. (2006). A meta-analysis of the technology acceptance model. *Information & Management*, 43, 740-755. doi:10.1016/j.im.2006.05.003
- Kuang-Ming Kuo, Chung-Feng Liu and Chen-Chung Ma(2013). An investigation of the effect of nurses' technology readiness on the acceptance of mobile electronic medical record systems. Kuo et al. *BMC Medical Informatics and Decision Making* 2013. Retrived from <http://www.biomedcentral.com/1472-6947/13/88>, 4 des 2014.
- Lin, C.-H., Shih, H.-Y., & Sher, P. J. (2007). Integrating technology readiness into technology acceptance: The TRAM model. *Psychology & Marketing*, 24, 641-657. doi:10.1002/mar.20177
- Lin, C.-H., Shih, H.-Y., Sher, P. J., & Wang Y.-L. (2005). Consumer adoption of e-service: Integrating technology readiness with the technology acceptance model. *Proceedings of PICMET '05*:



- Technology Management: A Unifying Discipline for Melting the Boundaries, Portland, Oregon, USA, 483-488. doi:10.1109/PICMET.2005.1509728
- Malhotra, Y., & Galletta, D. F. (1999). Extending the technology acceptance model to account for social influence: Theoretical bases and empirical validation. Proceedings of the 32<sup>nd</sup> Hawaii International Conference on System Sciences, Maui, Hawaii, USA, 1-14. doi:10.1109/HICSS.1999.772658
- Meredith, Jack R and Mantel, Samuel J., (1995). Project Management, A managerial Approach. John Willey & Sons, Inc. Canada. ( page 7-9).
- McFarland, D. J., & Hamilton, D. (2006). Adding contextual specificity to the technology acceptance model. Computers in Human Behavior, 22, 427-447. doi:10.1016/j.chb.2004.09.009
- Mimin Nur Aisyah, Mahendra Adhi Nugroho, Endra Murti Sagoro (2013). Pengaruh Technology Readiness Terhadap Penerimaan Teknologi komputer Pada UMKM di Yogyakarta. Jurusan Pendidikan akuntansi, Fakultas Ekonomi. Universitas Negeri Yogyakarta. Retrived from [http://staff.uny.ac.id/sites/default/files/penelitian/Endra %20Murti%20Sagoro,%20S.E.,M.Sc./Pengaruh%20Technology%20Readiness%20Terhadap%20Penerimaan%20Teknologi%20Komputer%20pada%20UMKM%20di%20Yogyakarta.pdf](http://staff.uny.ac.id/sites/default/files/penelitian/Endra%20Murti%20Sagoro,%20S.E.,M.Sc./Pengaruh%20Technology%20Readiness%20Terhadap%20Penerimaan%20Teknologi%20Komputer%20pada%20UMKM%20di%20Yogyakarta.pdf) . 25 Januari 2015.
- Murat Esen, Nihat Erdogmu, (2014). Effects of Technology Readiness On Technology Acceptance In E-HRM: Mediating Role of Perceived Usefulness. Bilgi Ekonomisi ve Yönetimi Dergisi / 2014 Cilt: IX Sayı: Retrived from <http://www.beykon.org/dergi/2014/SPRING/M.Esen.pdf>, 4 des 2014.
- Nadine Guhr, Tai Loi, Rouven Wiegard, and Michael H. Breitner. (2013). Technology Readiness in Customers' Perception and Acceptance of M(obile)-Payment: An Empirical Study in Finland, Germany, the USA and Japan. Leibniz Universität Hannover, Institut für Wirtschaftsinformatik, Hannover, Germany 11th International Conference on Wirtschaftsinformatik, 27th February – 01st March 2013, Leipzig, Germany. Retrived from <http://www.wi2013.de/proceedings/WI2013%20-%20Track%201%20-%20Guhr.pdf> . 25 January 2015.
- Nicholas, John M, (1990). Managing Business & Engineering Projects, Concepts & Implementation. Prentice Hall, Inc. USA. (page 3-6)
- Panday Rorim, John Tampil Purba. (2015). Lecturers and Students Technology Readiness in implementing Services Delivery of Academic Information System In Higher Education Institution: A Case Study. Paper for 4th International Conference on Soft Computing, Intelligent System and Information Technology 2015. Bali- Indonesia, 11-14 March 2015.
- Panday, Rorim (2015). The Effect of Technology Readiness on Technology Acceptance in Using Services Delivery of Academic Information System. Research Paper presented at 12th Insyma conference at Makassar 13-15 March 2015.
- Parasuraman, A. (2000). Technology readiness index (TRI): A multiple-item scale to measure readiness to embrace new technologies. Journal of Service Research, 2, 307-320. doi:10.1177/109467050024001
- Parasuraman, A., & Colby, C. L. (2001). Techno-ready marketing: How and why your customers adopt technology. New York: Free Press.
- PMBOK guide (1996). A Guide Project Management Body of Knowledge. Project Management Institute Standards Committee. USA. (page 28-29)
- PP Construction & Investment (2015, January, 30). Retrieved from : <http://www.pt-pp.com/index.php?m=home>
- Rita Walczucha, Jos Lemminkb , Sandra Streukens (2006). The effect of service employees' technology readiness on technology acceptance. Department of Accounting and Information Management, Faculty of Economics and Business Administration, Postbus 616, Maastricht University, The Netherlands. Elsevier, Information & Management 44 (2007) 206–215. Retrived from <http://arno.unimaas.nl/show.cgi?fid=10659>, 4 des 2014.
- Schepers, J., & Wetzels, M. (2007). A meta-analysis of the technology acceptance model: Investigating subjective norm and moderation effects. Information & Management, 44, 90-103. doi:10.1016/j.im.2006.10.007
- Tsikriktsis, N. (2004). A technology readiness-based taxonomy of costumers: A replication and extension. Journal of Service Research 7, 42-52. doi:10.1177/1094670504266132
- Venkatesh, V. (2000). Determinants of perceived ease of use: Integrating control, intrinsic motivation, and emotion into the technology acceptance model. Information Systems Research, 11, 342-365. doi:10.1287/isre.11.4.342.11872
- Venkatesh, V., & Davis F. D. (2000). A theoretical extension of the technology acceptance model: Four longitudinal field studies. Management Science, 46, 186-204. doi:10.1287/mnsc.46.2.186.11926



- Walczuch, R., Lemmink, J., & Streukens, S. (2007). The effect of service employees' technology readiness on technology acceptance. *Information & Management*, 44, 206-215. doi:10.1016/j.im.2006.12.005
- Wijaya, Tony. (2009). Analisis Structural Equation Modeling, Menggunakan AMOS. Universitas Atma Jaya Yogyakarta. (page 6-9)
- Yamin, Sofyan & Kurniawan Hei. (2009). Structural Equation Modeling, Belajar Lebih Mudah Teknik Analisis Data Kuesioner dengan Lisrel-PLS. Salemba infotek. (page 31-39)
- Yang, H.-D., & Yoo, Y. (2004). It's all about attitude: Revisiting the technology acceptance model. *Decision Support Systems*, 38, 19-31. doi:10.1016/S0167-9236(03)00062-9
- Yi, M. Y., & Hwang, Y. (2003). Predicting the use of web-based information systems: Self-efficacy, enjoyment, learning goal orientation, and the technology acceptance model. *International Journal of Human-Computer Studies*, 59, 431-449. doi:10.1016/S1071-5819(03)00114-9

# **ECONOMICS CHAPTER**

## **THE EFFECT OF CORE COMPETENCY ON COMPETITIVE STRATEGY AND ITS IMPLICATION ON THE PERFORMANCE OF THE ISLAMIC BANKINGS AND ISLAMIC MICROFINANCES IN THE PROVINCE OF ACEH, INDONESIA**

**Muslim A Djail**

Lecturer at Faculty of Economics, Syiah Kuala University, Banda Aceh, Indonesia

Email: [muslimadjail@gmail.com](mailto:muslimadjail@gmail.com) Hp : +628126980086

Prof . Dr. Radja Masbar, M.Sc

Professor of Economics at Faculty of Economics, Syiah Kuala University, Banda Aceh, Indonesia

Email: [r\\_masbar@yahoo.com](mailto:r_masbar@yahoo.com) Hp : +62811681365

**Syafuruddin Chan**

Lecturer at Faculty of Economics, Syiah Kuala University, Banda Aceh, Indonesia

Email: [syafuruddin.chan@gmail.com](mailto:syafuruddin.chan@gmail.com) Hp: +6281360797423

### **Abstract**

The main purpose of the research are to describe and investigate the causal relationship between core competency (e.g. Valuability, Rarity, In-imitability, Non-substitutability) on the performance (e.g. revenue growth, market share, and customer satisfaction) of the Islamic banking and Islamic microfinance in the Province of Aceh, Indonesia with competitive strategy (e.g. overall low cost leadership strategy, best cost provider strategy, and focused differentiation strategy) as an intervening variable. The research employed a quantitative survey toward 252 managers (top manager, middle managers, and operational managers) selected from 79 Islamic banking and Islamic Microfinance in the entire Province of Aceh. Hence, the type of research designs used is descriptive, verificative, and explanatory survey. While the research employed a five-rating likert scale measurement, and distributed the questionnaires as a data collecting tools, the collected data are processed by using Structural Equation Model (SEM) approach – AMOS SPSS version 22. The main finding of research indicated that core competency has a significant and positive influence on the performance of the Islamic banking and Islamic microfinance in the region either directly or through intervening variable of competitive strategy; the direct effect of core competency variable on performance is lower than that of the indirect effect of core competency on performance through intervening variables of competitive strategy. The other findings are the dimension of Rarity was the main determinant contributing to core competency, the dimension of focused differentiation strategy was a dominating dimension affecting of competitive strategy, and market share was a main determinant that forming the performance of the firm.

*Keywords: Core Competency, Competitive Strategy, Performance, Islamic Banking and Islamic*

*Microfinance*

### **1. Introduction**

Even though it was relatively new in the financing and banking industry, the Islamic finance and banking or more well known as an interest free or profit sharing based financing and banking are classified as the fastest growing segment in the world

financial service industry sector. The Islamic financial and banking institutions has expanded to over 35 countries with the sheer number of banks exceeding 100 Islamic banks and the value of assets already exceeded \$1 trillion, with an average annual growth rate of 15-20% within this last five years. The last two decades of amazing growth and outreach have put the Islamic finance and banking as one of the largest financial service industries in the world nowadays. (Vayanos & Wackerbeck. 2009; Ariff & Rosly: 2012; Galfy & Khiyar: 2012; Ismal, Rifki. 2013. ), The similar condition also applies in Indonesia, in general, and Aceh, in particular, which have a large number of Muslim community.

Based on the results of preliminary studies conducted by the author, the general Islamic banking in Aceh, did show an increase in its principal performance. However, when viewed as per indicator, the performance of Islamic banking in Aceh Province still keep a number of challenges that should be overcome by its related parties.

Some of the challenges mentioned above among others: (1) the low increase of third-party funds which impact on limited lending capacity and fund distribution in the form of financing which is a major source of revenue for any banking institutions; (2) the low market share of Islamic banking institutions which is recorded simply less than 10%, compared to the conventional banking institutions; (3) high price of financing products that have to be paid by the customer compared to those of conventional banks; (4) product differentiation in which there is no clear distinction between the features of banking products issued by Islamic Financial Institutions and banking products released by conventional financial institutions

The inability of Islamic banking and microfinance to gain a sustainable competitive advantage as well as the improper implementation of a cooperative strategy in this volatile competition intensity shows that Islamic banking and microfinance has not yet had a competitive core competence. In fact, a core competence is obviously a core skill that has to be possessed by a company to carrying out activities that are central for the company's competitive advantage strategy and for the achievement of superior business performance.

Based on the above problems and phenomena, the purpose of research are to describe and investigate the influence of core competency on the performance of Islamic banking and Islamic Microfinance in the province of Aceh, Indonesia with an intervening variable of competitive strategy.

## **II. Literature Review and Hypotheses**

### **2.1. Core Competence**

Despite its various differences regarding the terminologies and definitions of Core Competency, most strategic management scientists and practitioners agreed that Core Competency is a part of the Resource and Capability of the firm, which is derived from the Resource Based View (RBV) of the firm theory. Basically, the Resource Based View (RBV) theory suggested that internal environment of which consist of resources and capabilities including core competency are more important than that of external environment of which consist of general environment and industry environment. It also

considered that resources and capabilities are main source of competitive advantage and a main drivers of performance improvements.(Pearce II and Robinson,2013; Dess et. al, 2012; David, 2011; Ireland, Hoskisson and Hitt, 2011; West III and Bamford , 2010; Barney and Hesterly, 2012; Wheelen and Hunger, 2012).

According to Pearce II and Robinson (2013), core competency is a capability or skill that a firm emphasizes and excels in doing while in pursuit of its overall mission. The actual core competency does not lies on the amount of existing assets in the balance sheet but rather on the intellectual-based and intellectual-capital owned by the companies (Thompson Jr, 2010). Core competency will be the basis of competitive advantage if the resources and capabilities owned are distinctive competence that is a unique resource or capability to carry out a company activities that is outperform to the competitor (Thompson Jr, 2010; Pearce II, 2013). In practice, not all resources or capabilities serve as a core competency and a source of competitive advantage. The core competency will have a perceived value in the eyes of customers and a source of sustainable competitive advantage if it is critical, scarce, trigger resources, and durable (Pearce II, 2013); or if its resources and capabilities are Valuable (it is Valuable, Rare (It is Rare), Imitation (It is difficult to Imitate), Substitution (it cannot be Substituted for), Tradable (it cannot be Traded for). The underlying characteristics of unique resources and capabilities as a source of competitive advantage are termed as a VRIST framework (West III and Bamford, 2010).

Nearly similar to previous definition, according to Wheelen and Hunger (2013), Core competency a collection of competencies that crosses divisional boundaries, is widespread within the corporation, and is something the corporation can do exceedingly well. When the core competencies are superior to those of the competition, they are called “distinctive competency”. To test whether the resources and capabilities contributed to potentially competitive advantage, Barney and Hesterly (2012) proposed four questions need to be asked thoroughly or also referred it as a VRIO framework as follows;

1. The question Value: Does it provide customer value and competitive advantage?
2. The question of Rarity: Do no other competitors posses it?
3. The question of Imitability: Is it costly for others to imitate it?
4. The question of Organization: Is the firm organized to exploit the unique resource?

Based on the comparison of various references regarding core competency above and adjusted with the actual condition and object of the research and characteristic of respondents in the Province of Aceh, the dimensions or indicators that will be used in the research are divided into: Core Competency (CC) whose characteristics are (VRIN) = Valuability (CC1), Rarity(CC2), Inimitability (Costly to Imitate) or CC3, and Nonsubstituability) or CC4

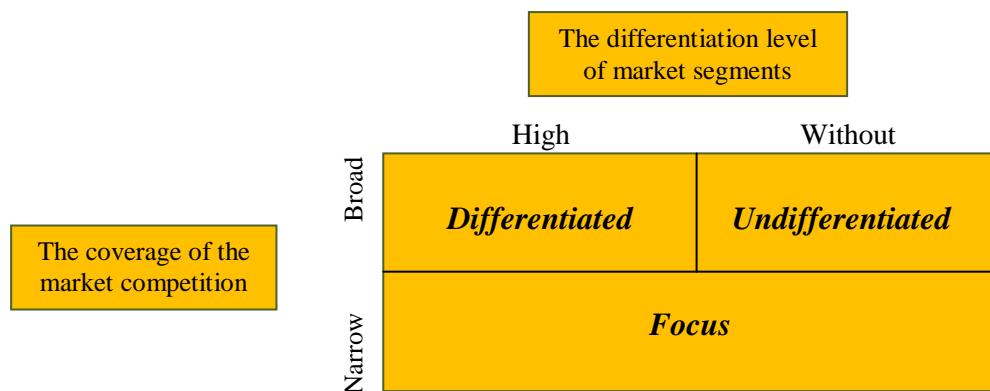
## **2.2. Competitive Strategy**

At least, there are three approaches that attempt to define the competitive strategies, namely adaptive strategy (Miles & Snow), a framework of business definition (Abell), and Porter’s Generic Competitive Strategies in Kuncoro, 2006.

Adaptive strategies of Miles and Snow version above are based on the organization's success in using the strategies to be able to adapt to an uncertain environment. In this approach there are four types of strategies, those are: prospector, defender, analyzer, and reactor.

According to Kuncoro (2006), prospector strategy is a strategy that promotes the organization's success in innovating, always creating new products and new market opportunities. Survival strategy or defender is a strategy that is usually concerned with the stability of its targeted market; generally, companies with this strategy only have a few product lines with a very narrow market segments. Analyzer strategy is a strategy that will analyze new business ideas before the organization entering the business. Reactor strategy is a strategy in which company reacts to the changing environment and makes a change only if there are pressures from the environment that forced the organization to change.

Abell's competitive strategies argue that businesses can be distinguished by two important aspects, i.e. the coverage of the competition (e.g. broad or narrow market) and to what extent does the product differentiation offered. The combination of the two aspects becomes the basis for Abell to find three possible competitive strategy, those are: differentiated, undifferentiated and focus, as shown in the Figure 2.1 below.

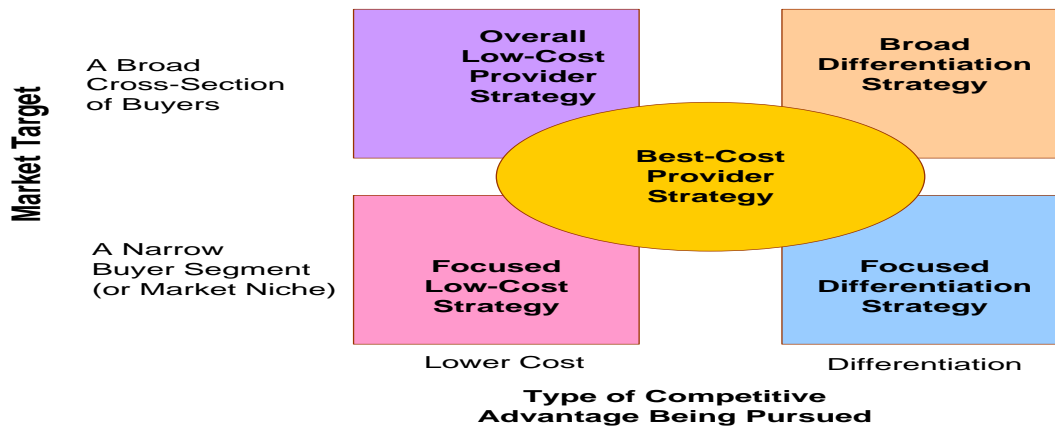


**Sumber:** Chrisman, et al (1988) in Kuncoro (2006, 90)

**Figure 2.1 Abell's Competitive Strategies**

Thompson Jr, Strickland & Gamble (2010), defined competitive strategy as a company's strategy deals exclusively with the specific of management's game plan for competing successfully its specific efforts to please customers, its offensive and defensive moves to counter the maneuvers of rivals, its responses to whatever market conditions prevails at the moment, its initiatives to strengthen its market position, and its approach to securing a competitive advantage vis-à-vis rivals. Similarly, Competitive strategy focuses on improving the competitive position of the company products and services in a particular industry or market segment served by the company (Wheelen and Hunger, 2013; Ireland & Hoskinson, and Hitt, 2011).

Furthermore, Thompson Jr, Strickland and Gamble (2010), dividing competitive strategy into five : (1) overall low cost strategy; (2) differentiation strategy in a large market; (3) best cost strategy; (4) low cost focus strategy; and (5) differentiation focus strategy. The form of this strategy can be seen in Figure 2.2 below.



**Source:** Thompson Jr , Strickland and Gamble (2010)

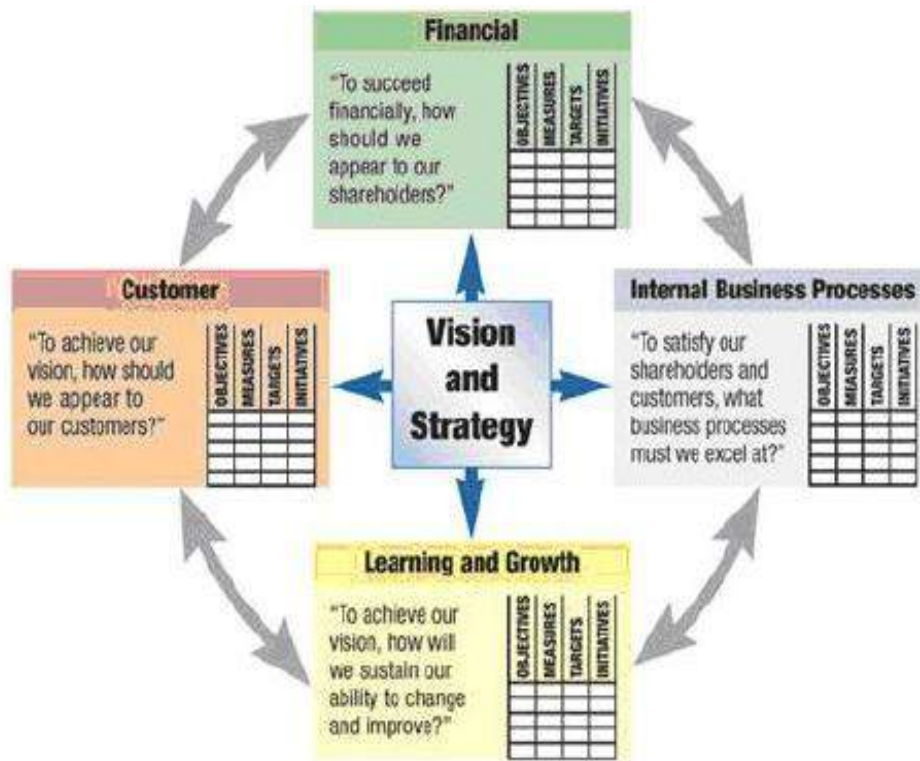
**Figure 2.2.**  
**Competitive Strategy of Thompson Jr, Strickland and Gamble Version**

The dimensions of competitive strategy (SKOM) that would be used in the research are into three : (1) Overall low cost strategy (SKOM1), (2). Best Cost Provider Strategy (SKOM2), and (3) Focused differentiation strategy (SKOM3)

### 2.3. Performance

Performance is the ending destination of any companies that are willing to pursue and it is a reflection of an entire achievement of process and afford the firms made. There are various approaches are used in defining performance and performance management. According to Mulyadi (2007), performance is the successful of personnel, team, or organizational unit in realizing the strategic objectives that have been set previously with the expected behavior. According to Rivai (2011), performance is a potential output of tasks achieved, by a person or by a group of a company, in accordance with one's authority and responsibility, in the efforts to pursue the goal of the company legally, morally, and ethically. In addition, Prawirosentono (2000) defines performance as a result of work accomplished within a certain time, in order to legally achieve the organization goals by not violating the law and in accordance with the moral and ethical. Bititci, Carrie & McDevitt(1997) define performance management as a "process by which the company manages its performance in line with its corporate and functional strategies and *objectives*". This definition is often used in management research studies. Bititci, Carrie & McDevitt elaborated that, it is therefore the objective of that process to provide an integrated control system, where the corporate and functional strategies are deployed to all business processes, activities, tasks and personnel, and feedback is obtained through the performance measurement system

to enable appropriate management decisions. Hence, the ultimate purpose of that process is to improve performance. There are two generally used approaches to measuring the company's performance advantages (Supratikno et. al., 2005), i.e. superior above average performance of a company and corporate longevity. The above concepts of measuring performance are often referred to as the concept of Balanced Scorecard (BSC) (Pearce II & Robinson, 2012 - adopted from Kaplan and Norton).



**Sumber:** Pearce II and Robinson 2012, adopted from Kaplan & Norton

**Figure 2.3.**  
**Performance Measurement with Balance Scorecard (BSC)**

The second approach of measuring company performance is by using a hybrid approach which is a combination of financial and non-financial measures (Gin Chong, 2008). The dimensions of each measurement both financial and non-financial can be seen in the following Table.

**Table 2.1**  
**Performance Indicators**

Financial Measurement		Non-financial Measurement	
Short-term	Long-term	Short-term	Long-term
<ul style="list-style-type: none"> <li>• Velocity of money</li> <li>• Return/Profit</li> <li>• ROI (Return On Investment)</li> </ul>	<ul style="list-style-type: none"> <li>• Revenue growth rate</li> <li>• Employees growth rate</li> </ul>	<ul style="list-style-type: none"> <li>• Customer's satisfaction</li> <li>• Waiting time guarantee on the delivery of goods to customer</li> <li>• Employees turnover</li> </ul>	<ul style="list-style-type: none"> <li>• Market share</li> </ul>



**Source:** Gin Chong (2008)

This approach is almost similar to what suggested by Ledwith and O'Dwyer, (2009), in which to measure the performance of the banking we can use financial approach and market performance with some main indicators, i.e.: sales growth, profitability, market share, the number of sales and ROI. The dimensions or indicators that would be used to measure the performance (KIN) in the research are grouped into : (1) Revenue growth (KIN12), (2). Market share (KIN12), and (3) Costumer's satisfaction (KIN13)

## 2.4. Islamic Finance and Islamic Banking

According to the book of Islamic Economics issued by Center for Islamic Economics Development and Study (CIEDS) and Bank of Indonesia (2008), the aims of Islamic economics is to achieve a prosperity that will bring happiness in this world and hereafter (Falah).

Islamic Banking is essentially an intermediary institution where the foundation of this intermediation can be seen in Surah An-Nisaa of Holy Quran verses 5 and 6, *mudaraba* practice has been implemented since the time of the Caliph Umar ibn Al-Khattab (Husaini & Dhani, 2007). In essence, Islamic banking operations are based on islamic principles for financial transactions, i.e., risk-sharing and prohibition of products and services having riba and profit and loss-sharing are major features, ensuring justices and equity ( Khir, Gupta and Shanmugam: 2008)

Islamic Banking is part of Islamic financial system. Therefore, to establish a strong and healthy Islamic banking system, it requires a systemic liquidity infrastructure, governance and disclosure infrastructure, as well as the supporting infrastructure and safety nets last loan.

Muhammad Syafi'i Antonio (2005) describes some main differences between Islamic banking and Conventional Banking, as shown in the table below:

**Table 2.2**  
**Main differences between Islamic and Conventional Banking**

No.	Islamic Bank	Conventional Bank
1	Conducting <i>halal sajab</i> investments	Halal and haram investments
2	Based on profit sharing, buying and selling, and leasing principles	Using interest
3	Profit dan <i>falah</i> oriented	Profit oriented
4	Partnership relationship with the costumers	Debtor – creditor relationship with the costumers
5	The association and distribution of funds shall be in accordance with the <i>Sharia</i> Supervisory Board <i>fatwas</i>	There is no such board

Source: Antonio (2005)

## 2.5. Hypotheses Development.

The proposed hypotheses are classified into descriptive and verificative as follows:

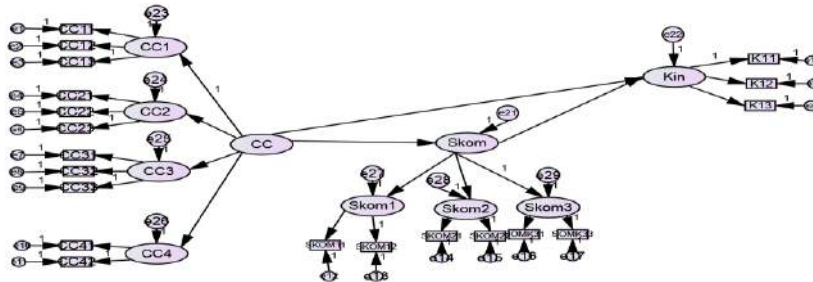
H1: Core competitive is not yet competitive, the competitive strategy is not yet sound, and the performance of Islamic banking and Islamic Microfinance in the Province of Aceh is not sound

H2. Core competence has a positive and significant influence on competitive strategy

H3. Core competence has a positive and significant influence on performance

H4. Competitive strategy has a positive and significant influence on performance

The proposed theoretical framework of the research may be seen in the following figure:



### 3. Research Method

This study is formulated based on the management science approach, especially economics with a focus area of strategic management, especially with regard to the core skills (core competency), competitive strategy, and its performance implications on Islamic Banking and Islamic Microfinance in the Aceh Province, Indonesia

In terms of research objectives, this study is a descriptive and an explanatory research which aimed at obtaining a description of the consideration or description of core skills (core competency), competitive strategy, performance of Islamic Banking and Islamic Microfinance in the Aceh Province, Indonesia. Besides, a verification process is also conducted to determine the variables effect through a hypothesis testing based on the data in the field.

This study employs two methods, i.e.: a descriptive survey method and an explanatory survey method. Therefore, the type of investigation used in this study is the causality type.

The unit analysis in this study is Islamic-based financial institutions which consist of Islamic Commercial Bank (BUS), Islamic Business Unit (UUS), Islamic Rural Banks (BPRS), and the Islamic Microfinance Institutions (LKMS) in all cities/districts in Aceh Province. This study uses one shoot coverage time with cross-section data type.

The research employed census method in the determination of respondents in which the sample is all of the population. The total number of observation units is 79 with the total number of respondent of 252 people from Islamic banking and its branch centers as well as Islamic Microfinance Institutions from all cities/districts in Aceh.

This study uses Structural Equation Model (SEM) approach – AMOS and the validity test and reliability test are conducted by using SPSS 22 that can be seen from the convergent validity with reflective indicator.

### 4. Results and Discussions

#### a). Characteristics of Respondents

The characteristics of respondents can be specified based on age, sex, education, formal education background, additional knowledge of Islamic banking, marital status, occupation, working-lives experience in Sharia-based financial institution management, levels of management, and income salary. According to sex, the respondents are dominated by men with a percentage of 64% while the number of

female respondents only about 36%. Most of them are in operations management positions with the percentage of 56.75%, middle management positions 30.95% and the rest of 12.30% is filled by those who hold top management positions.

In terms of education, 50% of the respondents are baccalaureate. The rest are high school graduates (13.89%), Diploma (32.14%), and Masters (3.97%). Moreover, the respondents who had educational background either diploma, bachelor or master, in non-Islamic banking field is dominating the population with the percentage of 83.33%, while those, who are with educational background in Islamic banking is only about 16.67%. This is understandable because there are only few educational institutions that provide Islamic-based economic/finance/banking field in Indonesia.

Most of the respondents, 58.73%, gained additional knowledge on Islamic banking through training/short courses. The rest 36.11% gained by way of self-study and 5.16% by other means such from colleagues. Judging from their marital status, 82.94% of respondents are married and the remaining of 17.06% are non-married. Most of the respondents, 87.70%, are private sector employees and the remaining 12, 30% are State Owned Enterprise (BUMN) employees.

According to their working-live experience in Sharia-based financial institutions, 22.22% are those who have hold manager positions for more than 5 years, then from 3 to 3.9 years (18.65%), 1 to 1.9 years (17.86%), 2 to 2.9 years (14.68%), 4-5 years (14.29%), and under one year (12.30%).

While according their income salary, 34.52% of respondents earn less than two million rupiahs. This is because most of the respondents taken are those who work at the Sharia based Microfinance Institutions (LKMS) in which their financing stakeholders are small and medium businesses (SMEs). While a small percentage of 6.75% is filled by those who have incomes 5-6 million rupiahs, and the remaining is 2 to 2.9 million rupiahs (26.98%), Rp.3 to 3.9 million rupiahs (11.11%), 4 to 4.9 million rupiahs (9.92%), and 6 million rupiahs (10, 71%).

## **b). The Description of Core Competency, Competitive Strategy, and Performance of Islamic Banking and Islamic Microfinance in the Aceh Province, Indonesia**

This section aims to describe the condition of analysis unit based on variables study. The calculation of the distribution frequency table of descriptive statistics is made to provide a clearer picture of the analysis unit. The categorization of each variable based on the average count is presented in the following table.

**Table 4.1 Categorization of Research Variable**

Range	Category
1.00 - 1.79	Very unsatisfied
1.80 - 2.59	Unsatisfied
2.60 - 3.39	Neutral
3.40 - 4.19	Satisfied
4.20 - 5.00	Very satisfied

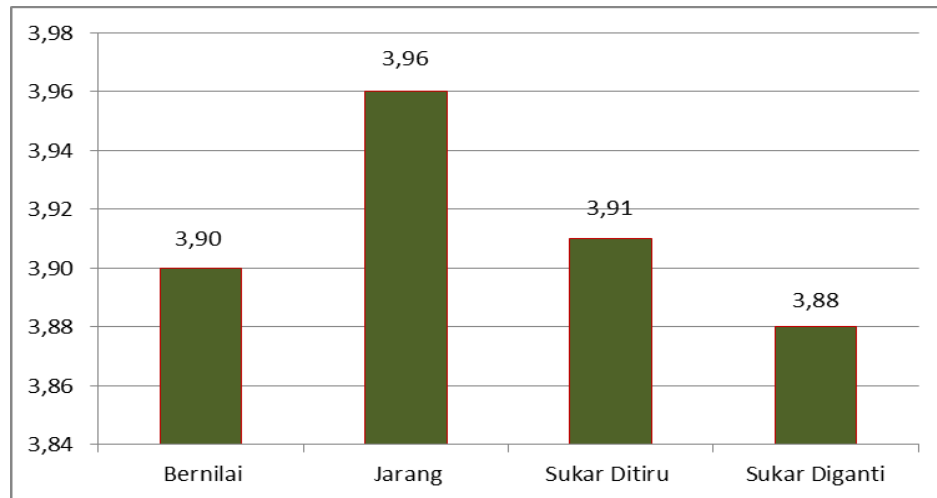
**Source:** Data Processing Output, 2013

The categorization table uses range or interval 0.8, which is obtained from the reduction of the greatest value on the Likert scale (5) and the smallest value (1) and divided by its own number of categorization (5).

### **1) Core Competency**

Core competency variable is measured through four dimensions, i.e: resources and worth capabilities or *Valuable (Bernilai)*, resource and rare capabilities or *Rare (Jarang)*, resources and difficult to imitated capabilities or *Inimitable (Sukar ditiru)* as well as resources and difficult to replace capabilities or *Unsubstitutable (Sukar diganti)*. The average value for the aspect of resources and worth capabilities is relatively high, approaching almost 4. This indicator provides the highest average figure of Islamic

banking and Islamic Microfinance's ability to reach the targeted consumers which is more aggressive than the conventional banking.



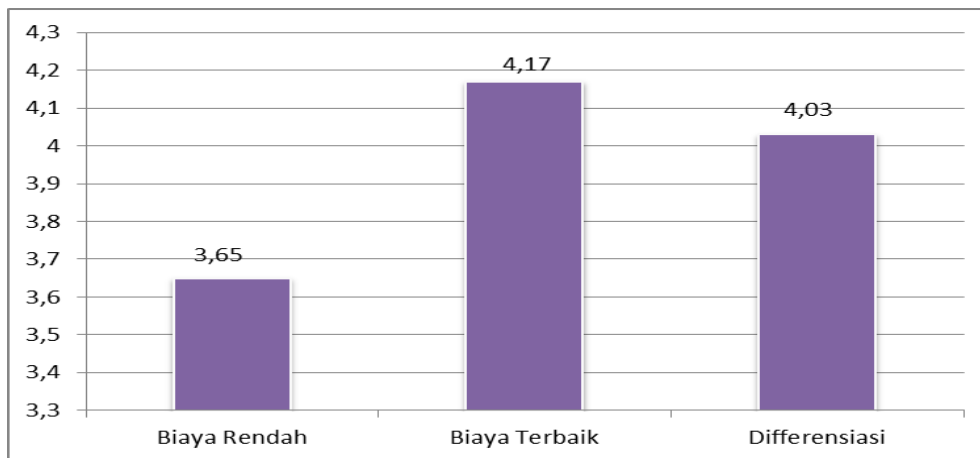
Source: Data Processing Output, 2013

**Figure 4.1 Core Competency's Recapitulation**

The above figure shows the summary of the total average of each dimension used to measure the core competency variable. The most visible one is the resources and rare capabilities with an average value of 3.96, and the lowest is the resources and difficult to replaced capabilities with an average value of 3.88.

2) **Competitive Strategy**

Competitive strategy variables measured through 3 dimensions, i.e.: low cost leadership (*Biaya Rendah*), Best Cost Leadership (*Biaya Terbaik*) and Differentiation (*Diferensiasi*)



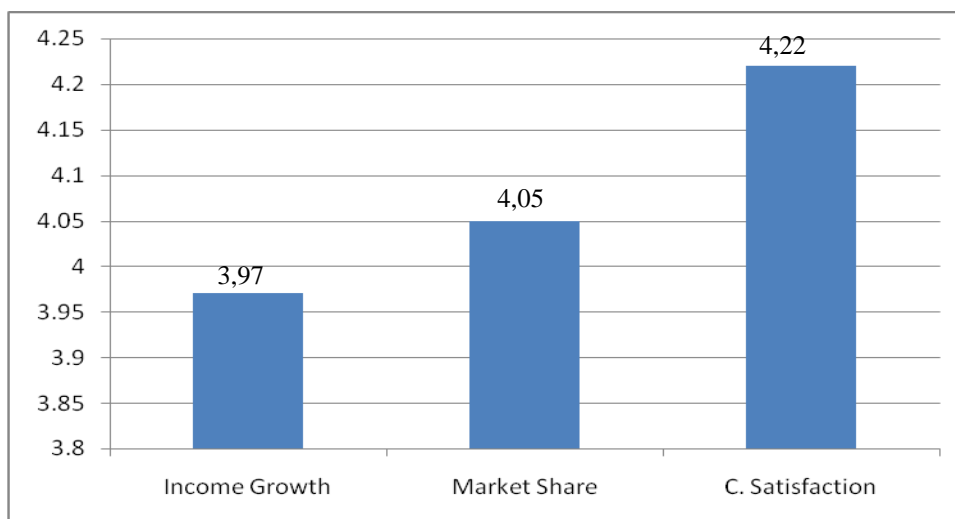
Source: Data Processing Result, 2013

**Figure 4.3 Competitive Strategy's Recapitulation**

The picture above shows the summary of total the average of competitive strategy variable dimension. The highest score is Best Cost dimension with an average value of 4.17, and the lowest one is the low cost dimension with an average value of 3.65. From these figures it can be seen that the competitive strategy of the company is mostly derived from the ability of Sharia-based financial institutions in the best costing run.

### 3). The Performance of Islamic Banking and Islamic Microfinance in the Aceh Province, Indonesia

The Performance of Islamic Banking and Islamic Microfinance variables measured through three dimensions, i.e.: the average growth rate of the company, market share and the improvement of customer satisfaction from time to time. From those three indicators as show in the above figure, the improvement of customer satisfaction from time to time has the highest score of 4.22. This result shows that such performance only can be achieved if the customer satisfaction rate continues to increase from time to time. The second one is the market share indicators with the value of 4.05. This means that the market share improvement is still difficult to perform, though it is a very important aspect in improving the company performance.

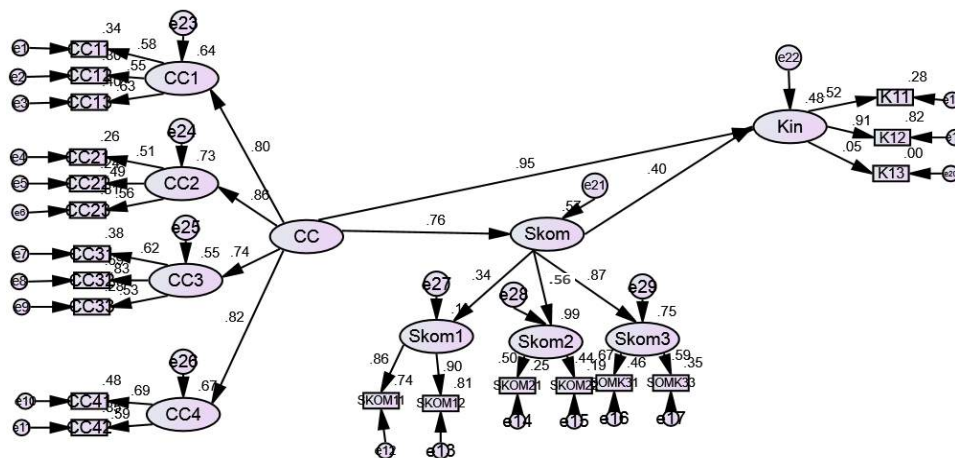


Source: Data Processing Result, 2013

Figure 4.5 Performance's Recapitulation

#### c). The Influence of Core Competency on Performance of Islamic Banking and Islamic Microfinance in the Aceh Province, Indonesia with the intervening variable of Competitive strategy

Having conducted the test of Validity and Reliability of indicators and dimensions of which indicated that all of them are valid and reliable, it will be continued with the formulation of the Measurement Model. As a part of SEM model, the Measurement Model is principally employed to measure at what extend a set of indicators or manifest variables precisely explained constructs or latent variables. It would cover testing the employed indicators that measuring variables, calculating covariance of selected samples in order to identify the relationship between indicator and construct, and Goodness of Fit (GoF). The next step is to develop a Structural Equation Model (SEM) to test the proposed model and hypotheses developed in the research. The testing of the developed model in the SEM is performed by two methods, namely, the test of model fitness and significant test of causality through the test of regression coefficient. Finally, it is based on previously developed theoretical framework of research, both measurement and structural model are combined to formulate the Full Model. Using the covariance based SEM with Amos software, the output of data processing of the research can be seen in the following Full model figure:



Source: Data Processing Result, 2013

Figure 4.6. Full Model

**Note:** CC: Core Competency; CC1: Valuability, CC2: Rarity, CC3: Inimitability, CC4: Nonsubstituability  
 Skom: Competitive Strategy; Skom1: Overall Low Cost leadership strategy, Skom2: Best Cost Provider Strategy; Skom3: Focused t differentiation; Kin: Performance: Kin11: Revenue Growth, K12: Market Share, K13: Customer satisfaction

The causal relationship above which is based on the proposed hypothesis should be statistically tested partially and simultaneously by using Critical Ratio (CR) and Probability Value (P). The test of those hypotheses are done by using two cut-off value by comparing the CR with 1,96 and P Value with 0.05. The influence will be stated significant if the value of  $CR > 1,96$  and P Value  $< 0.05$  (Latan.2013). Based on the output of the Regression weight and standardized regression weight of measurement model and structural model of SEM-Amos as shown in the appendix 1 and appendix 2, it will be determined the significance and the dominating influence of each indicator or dimension forming the variable of the measurement model and also reveals the extend and the significance of causal relationship among variables of the structural model.

The output of regression and standardized regression of the measurement model indicated that all indicators and dimensions forming the three variables of the research (core competency, competitive strategy, and performance) are significance due to its value of  $CR > 1,96$  and value of  $P < 0.05$  (see appendix 1). The output also shows that the dominating dimension forming core competency is Rarity whose loading factor is the highest by .86. The loading factors of Valueability, Inimitability, and Nonsubstituability dimensions are .80, 0.74, 0.82, respectively; the dominating dimension forming the competitive strategy is focused differentiation strategy of which it's loading factor is .87. The loading factors of overall low cost leadership strategy and the best cost provider strategy are .34 and .56, respectively; and the dominating dimension forming the variable of performance is market share whose loading factor is .91, and the loading factor of revenue growth and customer satisfaction dimensions are .52 and .05, respectively.

While the output of regression and standardized regression of measurement model explaining the dominating and the significant influence of indicators/dimensions toward variable, the output of regression and standardized regression of structural model revealing the extend and the significant causal relationship among research variables. The output of regression and standardized regression of structural

model as attached in the appendix 2 indicated the extend of influence which is reflected with the value of loading factors; the higher of the loading factor is the closeness of the influence among variables. The output of cut-off value of statically significant causal relationship of which is stated with the value of CR> 1.96 and value of P<0.05 (Latan.2013). The output of loading factors, CR Value, and P Value of the research sample and the outcome of hypotheses testing of causal relationship are summarized on the following table:

**Table 4.2.**  
**Summary of Hypotheses Testing**

No	Hypothesis	Remarks	Loadi ng Factor (R)	CR	P	The test of Significance	Reject /Accept of H1 Hypotheses
1	2	Core Competency has a positive and significant influence on Competitive Strategy	.671	4.900	***	Significance	H <sub>1</sub> Accepted
2	3	Competitive Strategy has a positive and significant influence on Performance	.620	2.745	.008	Significance	H <sub>1</sub> Accepted
3	4	Core Competency has a positive and significant influence on and Performance	.827	3.336	***	Significance	H <sub>1</sub> Accepted

*Note: The hypothesis would be accepted if P-Value or p < 0,05 and CR value > 1,96 (Latan.2013)*

**Source:** Data Processing Output, 2013

#### 4. Conclusion and Recommendation.

##### 4.1 Conclusions

1. The core competency of the Islamic banking and Islamic Microfinance in the Province of Aceh has not been competitive yet, the competitive strategy has not been sound yet, and the performance of the institutions have been sound and increasing
2. Most managers working in the Islamic banking and Islamic Microfinance in the Province of Aceh did not have a specific sharia based financial education from formal universities or colleges, most of them obtain the skills and knowledge of sharia based finance and banking system by short course or training
3. Out of three hypotheses of causal relationship tested as previously explained, all of them have a positive influence, significant and accepted. The Core Competency has a positive and significant influence on Competitive Strategy, Competitive Strategy has a positive and significant influence on Performance, and Core



Competency has a positive and significant influence on and Performance of Islamic banking and Islamic Microfinance in the Province of Aceh

4. Rarity, focused differentiation, and market share are the most dominating dimensions forming the variables of core competency, competitive strategy, and performance of Performance of Islamic banking and Islamic Microfinance in the Province of Aceh, respectively.

5. The direct effect of core competency variable on performance is lower than that of the indirect effect of core competency on performance through intervening variables of competitive strategy

#### 4.2. Recommendations

1. Boasting the company's performance, the stakeholders and management of Islamic banking and Islamic microfinance in the Province of Aceh should thoroughly leverage its core competency through optimalization of competitive strategy
2. The further research regarding the subjects are greatly encouraged to explore the variables affecting performance of Islamic banking and Islamic microfinance in regions or replicated it with other variables or different samples in the other regions

#### References

- Antonio. Muhammad Syafie. 2001. *Bank Syariah: dari Teori ke Praktik*. Jakarta: Gema Insani.
- Ariff, Mohamed, Saiful Azhar Rosly. Islamic Banking in Malaysia: *unchartered Water*. *Asian Economic Policy Review*. Japan Center for Economic Research (2011)6, 301-319
- Bank Indonesia, Direktorat Perbankan Syariah. 2011. *Outlook Perbankan Syariah 2010, 2012*
- Bank Indonesia, Banda Aceh. (2012). *Kajian Ekonomi Regional Propinsi Aceh, Triwulan III, 2012*
- Barney, Jay. B, and William. S Hesterly. 2012. *Strategic Management and Competitive Advantage, Fourth Edition*. Pearson Prentice Hall, United States of America
- Bititci, U. S., Carrie, A. S., & McDevitt. 1997. Integrated Performance Measurement Systems: A Development Guide. *International Journal of Operations & Production Management*, 17(5), 522–534.
- Chong, Gin. 2008. Measuring Performance of Small-and-Medium Sized Enterprises: the Grounded Theory. *The Journal of Business and Public Affairs*. Volume 2, Issue 1, 2008
- David, Fred R. 2011. *Strategic Management: Concepts and Cases, Twelfth Edition*. USA: Pearson Education.
- Dess, Gregory G at. al. 2012. *Strategic Management: Text and Cases. Sixth edition*. USA: McGraw-Hill
- El-Galfy, Ahmed, Khiyar Abdalla Khiyar. 2012. Islamic Banking and Economic Growth: A Review. *Journal of Applied Business Research*. Sept/Oct.; 2012; 28,5; ABI/INFORM Complete
- Hendrawan, Supratikno, Anton Wachidin Widjadja, dan Darmadi Durianto. 2006. *Manajemen Kinerja untuk Menciptakan Keunggulan Bersaing*. Penerbit Graha Ilmu. Yogyakarta.
- Ireland, Duane R, Robert E Hoskinsson, Michael Hitt. 2011. *The Management of Strategy: Concept and Cases. 9<sup>th</sup>. Edition*. USA: South –Western Cengage Learning.
- Ismal, Rifki. 2013. *Islamic Banking in Indonesia: New Perspectives on Monetary and Financial Issues*. Singapore. John Wiley & Sons Pte.Ltd
- Khair, Kamal, Lokesh Gupta, and Bala Shanmugam. 2008. *Longman Islamic Banking: a Practical Perspective*. Pearson Malaysia Sdn.Bhd.
- Kuncoro, Mudrajad. 2003. *Metode Riset untuk Bisnis dan Ekonomi*. Jakarta: Erlangga.
- Latan, Hengki. 2013. *Model Persamaan Struktural: Teori dan Implementasi Amos 21*. Bandung: Penerbit Alfabeta
- Ledwith, A., & O'Dwyer, M. (2009). Market Orientation, NPD Performance, and Organizational Performance in Small Firms. *Journal of Product Innovation Management*, 26(6), 652- 661.
- Ma, Hao. 2004. Toward Global Competitive Advantage : Creation, Competition, Cooperation, and Co-option, *Journal of Management Decision*, Vol.42 No 7, pp.907-924.
- Mulyadi. 2009. Mulyadi. 2009. *Sistem Terpadu Pengelolaan Kinerja Personel Berbasis*



*Balanced Scorecard*. Yogyakarta: Unit Penerbit dan Percetakan Sekolah Tinggi Ilmu Manajemen YKPN.

Pearce II, John A, and Richard B Robinson. 2013. *Strategic Management: Planning for Domestic and Global Competition, Thirteenth Edition*. MC Graw Hill Company, Inc.

Porter, E. Michael. 1993. *Competitive Advantage*. Collier Macmillan Publisher.

Prawirosentono, Suryadi. (2000). *Kebijakan Kinerja Karyawan*. BPFE, Yogyakarta.

Rivai et. al (2012). *Corporate Performance Management: dari Teori ke Praktik*. Bogor. Indonesia: Penerbit Ghalia Indonesia

Thompson Jr, A Arthur, A.J.Strickland, and E. John Gamble. 2010. *Crafting and Executing Strategy The Quest for Competitive Advantage: Concept and Cases, 17<sup>th</sup>. Edition*. The McGraw Hill company, USA.

Vayanos, Peter and Wackerbeck, Philipp. 2009. *Islamic Banking: How Do Islamic Banks Compete in an Increasingly Competitive Environment*. Booz & Company. Germany

Walker, Gordon. 2009. *Modern Competitive Strategy, Third Edition*. McGraw Hill International.

West III, G., Page, Charles E. Bamford. 2010. *Strategy: Sustainable Advantage and Performance*. Canada: South-Western, Change Learning.

Wheelen, L. Thomas, J. David Hunger. 2013. *Strategic Management and Business Policy: Toward Global Sustainability. Thirteenth Edition*. USA: Pearson.

### Appendix 1. Regression & Standardized Regression Weight from Measurement Model

**Estimates (Group number 1 - Default model)**  
**Scalar Estimates (Group number 1 - Default model)**  
**Maximum Likelihood Estimates**  
**Regression Weights: (Group number 1 - Default model)**

			Estimate	S.E.	C.R.	P	Label
Skom	<---	CC	.671	.137	4.900	***	par_11
CC3	<---	CC	.854	.161	5.308	***	par_8
CC1	<---	CC	1.000				
CC2	<---	CC	.808	.145	5.591	***	par_9
CC4	<---	CC	1.173	.211	5.565	***	par_10
Kin	<---	Skom	.620	.226	2.745	.008	par_12
Skom1	<---	Skom	.917	.264	3.480	***	par_18
Skom2	<---	Skom	1.049	.241	4.354	***	par_19
Skom3	<---	Skom	1.000				
Kin	<---	CC	.827	.248	3.336	***	par_20
K11	<---	Kin	1.000				
K12	<---	Kin	2.008	.387	5.185	***	par_16
K13	<---	Kin	.3091	.114	2.711	.004	par_17

**Standardized Regression Weights: (Group number 1 - Default model)**

			Estimate
Skom	<---	CC	.757
CC3	<---	CC	.741
CC1	<---	CC	.800
CC2	<---	CC	.857
CC4	<---	CC	.818
Kin	<---	Skom	.400
Skom1	<---	Skom	.335
Skom2	<---	Skom	.996

			Estimate
Skom3	<---	Skom	.867
Kin	<---	CC	.947
CC13	<---	CC1	.630
CC12	<---	CC1	.549
CC11	<---	CC1	.579
CC23	<---	CC2	.555
CC22	<---	CC2	.490
CC21	<---	CC2	.511
CC33	<---	CC3	.533
CC32	<---	CC3	.831
CC31	<---	CC3	.617
CC42	<---	CC4	.589
CC41	<---	CC4	.695
SKOM12	<---	Skom1	.899
SKOM11	<---	Skom1	.860
SKOM22	<---	Skom2	.441
SKOM21	<---	Skom2	.499
SOMK33	<---	Skom3	.593
SOMK31	<---	Skom3	.675
K11	<---	Kin	.525
K12	<---	Kin	.907
K13	<---	Kin	.049

**Appendix 2. Output of Regression and Standardized Regression Weight of Structural Model**

**Estimates (Group number 1 - Default model)**  
**Scalar Estimates (Group number 1 - Default model)**  
**Maximum Likelihood Estimates**  
**Regression Weights: (Group number 1 - Default model)**

			Estimate	S.E.	C.R.	P	Label
Skom	<---	CC	.671	.137	4.900	***	par_11
Kin	<---	Skom	.620	.226	2.745	.008	par_12
Kin	<---	CC	.827	.248	3.336	***	par_20

**Standardized Regression Weights: (Group number 1 - Default model)**

			Estimate
Skom	<---	CC	.757
Kin	<---	Skom	.400
Kin	<---	CC	.947

# Sustainability in Microfinance : A Review of The Empirical Literature

<sup>1</sup>Indayani and <sup>2</sup>Manatap Berliana Lumban Gaol

<sup>1</sup> Ph.D student, Diponegoro University, Semarang, Indonesia and Lecture,  
Department of Accounting, Syiah Kuala University, Aceh, Indonesia  
Email: [inya74@gmail.com](mailto:inya74@gmail.com), Phone: 085260504743

<sup>2</sup> Ph.D student, Diponegoro University, Semarang, Indonesia  
Email: [ber1iana@yaoo.co.id](mailto:ber1iana@yaoo.co.id), Phone:081361019990

## Abstract

This paper presents results of scientific literature about sustainability in microfinance. Sustainability have progressively increased their importance within long survive organizations in microfinance. The literature review has shown some important things a relationship in terms of many variabel with sustainability. several suggestions for future researches are indicated.

*Keyword: Microfinance, Sustainability, Review, Peformance, Efficiency, Corporate Governance*

## 1. Introduction

The issue of microfinance has become a hot topic over the last year, both of stakeholders and researchers. Microfinance has been widely known for adopting a simple mission to reduce poverty by providing small loans to people who are economically active but not bankable. Microfinance has a dual purpose, perform financial tasks and social tasks, so that in principle MFIs face the challenges of the double bottom-line between outreach and sustainability ([Paxton & Fruman, 1997](#); [Rhyne, 1998](#); [Robinson, 2001, 2002](#); [Isern & Porteous, 2005](#); [Helms, 2006](#); [Torre & Vento, 2006](#); [Ledgerwood, 2008, 2013](#)).

According to [Robinson \(2001\)](#) the key to the sustainability of an MFI is the necessity of commercial objectives (profit-making objective), the ability to generate profits, in addition to the social mission carried. While, [Torre and Vento \(2006\)](#) stated that sustainability can be understood as the ability of MFIs provide ongoing financial assistance (Substantial financial sustainability). In a strict sense, to be a sustainable institution, an institution will assistance and benefit from interest and commissions or profit sharing, which can cover the operating costs, the cost of inflation, devaluation of the portfolio, financial costs, risk premium and the rate of return for investors.

Lately, however, there seems to be a shift of subsidies MFI institutions to focus on the sustainability of microfinance. This objective emphasizes the importance able to cover the cost of the revenue generated from the loan portfolio and to reduce costs as much as possible. Increasing focus on financial sustainability as a business development of microfinance recently faced with increasingly fierce competition among MFIs, microfinance commercialization ie, the interests of commercial banks and investors to finance MFIs, changes in available technology and implemented in microfinance, liberalization financial and regulatory government policies ([Rhyne & Otero, 2006](#)).

A lots of studies have tried to explain the issue of sustainability in microfinance. This literature review trying to trace the development of sustainability research and the variables that influence it. The paper is arranged as follow, the second section briefly describes microfinance sustainability, the third section describes method, the fourth section study in microfinance sustainability, the fifth discussion and last section, conclusion and suggestion.

## 2. Sustainability of microfinance

Sustainability of microfinance is to find a balance between costs and benefits. Sustainability is an important consideration of microfinance institutions, donors and investors who provide financial support for microfinance and various other stakeholders. To achieve sustainability, various conditions must really be created in order to get his return continuously. This condition is necessary for the institution to finance the initiative of adequacy, for example from the outside contribution. Sustainability of microfinance is traditionally associated with social benefits, this means though is not limited as the ability to reach the poorest sectors of the beneficiaries [Robinson \(2001\)](#).

"In microfinance, sustainability is understood primarily as the ability of MFIs to repeat loans over time (substantial financial sustainability), Regardless of how the financial stability of the project or institution is Achieved" ([Torre & Vento, 2006](#)). It is meaningful sustainability of microfinance is a

continuous turnover the loan. Substantial financial sustainability describes the ability to cover the costs required at the beginning and at the time of establishment of management activities already running. Therefore, to become financially sustainable institution should receive aid flows and profit from interest and fees to cover operating costs, the cost of inflation, devaluation of portfolio costs, financial costs, risk premium and return of capital shareholders.

The entry of private investors into the microfinance market and the increasing scarcity of public funds, has been brought to the attention of financial self-sustainability of microfinance actors. When microfinance institutions refer to the substantial financial sustainability, grants and assistance is also included among the items which contribute to closing costs and stabilize revenue microfinance institutions. While financial self-sustainability, grants and soft loans are not to be considered in assessing the ability of independent institutions to cover the costs. "With regard to financial self-sustainability, it is Necessary to further distinguish operational between self -sufficiency (where the operating income covers operating costs, the cost of inflation, loan loss provision and currency risk loss provisions) and fully financially self-sufficiency (where the operating incomes is enough to cover not only operating costs, inflation costs and provisions, but Also the financing costs, the which include debts costs and the adjusted cost of capital) " ([Torre & Vento, 2006](#)).

Analyzing sustainability is important for any type of business or economic activity performed. There are two important reasons to consider for the sustainability of microfinance, ([Torre & Vento, 2006](#)), "note that in microfinance and for MFIs especially, it represents a crucial element for two reasons. First, MFIs work with marginalized clientele, who are not accepted in the formal financial system as they are considered too risky and not profitable enough. Therefore, it would be logical to assume that the institutions that decide to work with such client have greater problems in covering costs with an adequate profit flow in the medium to long term. Secondly, the operating costs necessary for the screening of trustworthy individuals and small business and the monitoring of those borrowers are such that, when compared to the profit made from a single client, they could show little advantage in working for such small amounts". This suggests that because microfinance beneficiaries are marginal groups who are not eligible in the formal financial system are considered too risky and unprofitable, will brought great trouble to cover costs in the medium term and long term.

Sustainability of microfinance institutions are also strongly related to the nature of microfinance. In this case there are two opposing theories: Financial Services Approach and poverty Lending Approach. In the first approach, microfinance is considered as a further division of the financial services market, with the goal of achieving financially excluded individuals who had limited access to the formal financial system. The second approach tends to petrify a small number of population in a short time and only provide basic services.

### 3. Method

The method used was analyze previous studies that examining the relationship between certain variables with sustainability. Initial normative studies and empirical research reviewed and classified by variables. This was followed by more recent research review that addresses the theme of corporate governance and information Technology in microfinance.

### 4. Study in Microfinance Sustainability

This section contains analysis of studies examining the relationship between particular aspects with sustainability. In the early research into sustainability themes studied the relationship between outreach and sustainability are very popular, the variable range of outreach defined and measured in various ways. In the subsequent discussion, the theme of a particular variable relationship with sustainability classified as shown in Table .1 contains a summary of empirical research studies are reviewed.

**Table 1.** Summary of the study: The relationship of particular variables with sustainability

A. Outreach and Sustainability			
Name / Year	Title	objects	Results
<a href="#">Christen et al. (1995)</a>	Maximizing the Outreach of Microenterprise Finance: an analysis of Successful Micro finance programs	<b>Object:</b> 11 microfinance institutions.	The positive influence MFI on the socio-economic welfare of the poor can only be maintained if the MFI's financial have good performance and outreach

<a href="#">Makame and Murinde (2006)</a>	Empirical Findings on Cognitive Dissonance Around Microfinance Outreach and Sustainability	<b>Object</b> : South Africa	does not support the trade-off between outreach and sustainability
<a href="#">Cull et al. (2007)</a>	Financial Performance and Outreach: A Global Analysis of Leading Microbanks	<b>Object:</b> 124 institutions in 49 countries	no significant
<a href="#">Babandi (2011)</a>	Micro Finance Institutions in Nigeria Outreach and Sustainability: Questionnaire Survey Findings	<b>Object:</b> Microfinance Institutions in Nigeria	there was no significant difference
<a href="#">Kar (2011)</a>	Microfinance Institutions: a Cross-Country Empirical Investigation of outreach and sustainability	<b>Object:</b> 426 institutions in 81 countries	breadth of outreach assist the process of achieving sustainability.

#### B. Efficiency and Sustainability

Name / Year	Title	Objects	Results
<a href="#">Qayyum and Ahmad (2006)</a>	Efficiency and Sustainability of Micro Finance Institutions in South Asia	<b>Object:</b> South Asian countries	do not meet this criterion of sustainability
<a href="#">Nawaz (2010)</a>	Issues in subsidies and sustainability of microfinance: An empirical investigation	<b>Object:</b> 179 MFIs in 54 Countries worldwide	The empirical evidence lends support to the importance of financial and social efficiency in determining the interest rate policy of microfinance Institutions
<a href="#">Nadiya et al. (2012)</a>	Dangers in Mismanaging the Factors Affecting the Operational Self-Sustainability (OSS) of Indian Microfinance Institutions (MFIs)-An Exploration into Indian Microfinance Crisis	<b>Object:</b> Indian Microfinance Institutions	cost efficiency factor have a positive influence on the OSS of Indian MFIs
<a href="#">Kablan (2012)</a>	Microfinance efficiency in the West African economic and monetary union: have reforms promoted sustainability or outreach?	<b>Object:</b> West African	results show that social efficiency decreases, while financial efficiency increases.

#### C. Regulation and Sustainability

Name / Year	Title	Objects	Results
<a href="#">Cull et al. (2011)</a>	Does Regulatory Supervision Curtail Microfinance Profitability and Outreach?	<b>Object:</b> 346 microfinance institutions (MFIs) in 67 developing countries	Supervision no significant relationship between supervision and profitability

#### D. Competition and Sustainability

Name / Year	Title	Objects	Results
-------------	-------	---------	---------

( <a href="#">KAI, 2009</a> )	Competition and Wide Outreach of Microfinance Institutions	<b>Object:</b> 450 socially-MFIs in 71 countries	Competition does not have a significant impact on FSS
<b>E. Capital Structure with Sustainability</b>			
Name / Year	Title	Objects	Results
Haruna Sekabira, 2013	Capital Structure and Its Role on Performances of Microfinance Institution. The Uganda Case	<b>Object:</b> 14 MFIs in Uganda.	mixed results
Vicki L. Bogan (2012)	Capital Structure and Sustainability: An Empirical Studi of Microfinance Institution.	<b>Object :</b> Africa, East Asia, Eastern Europe, Latin America, Middle East, and South	mixed results
Hoque dkk, 2011	Commercialization and Changes in Capital Strucuture in Microfinance Institution.	<b>Object:</b> 24 MFIs in Central and South America, Africa, Eastern Europe, and Asia.	Significant negatif
Anthony Kyereboah-coleman (2007)	The Impact of capital strucuture on the performance of microfinance institution.	<b>Object:</b> 52 MFIs in Ghana	Significant
<b>F. Cost Structure and Sustainability</b>			
Name / Year	Title	Objects	Results
Zahid Islam, Marcela Porporato, 2014	Cost Structure and Financial Sustainability of Microfinance Institutions: The Potential Effects of Interest Rate Cap in Bangladesh	<b>Object:</b> 216 LKM di Bangladesh	general administration costs only affect the ROA
<b>G. Corporate Governance and Sustainability</b>			
Name / Year	Title	Objects	Results
( <a href="#">Aboagye and Otioku (2010)</a> )	Are Ghanian MFI's Performance Associated with Corporate Governance?	<b>Object:</b> 30 RBs in Ghana	Corporate governance has no effect on the financial performance.
( <a href="#">Mersland and Strøm (2009)</a> )	Performance and governance in microfinance institutions	<b>Object:</b> 278 MFIs from 60 countries	mixed results
( <a href="#">Kyereboah-Coleman &amp; Osei, 2008</a> )	Outreach and profitability of microfinance institutions: the role of governance	<b>Object:</b> 52 MFIs in Ghana	mixed results
( <a href="#">Hartarska (2005)</a> )	Governance and Performance of Microfinance Institutions in Central and Eastern Europe and the Newly Independent States	<b>Object:</b> 71 MFIs in Europe	mixed results

## 5. Discussion

In many literatures and among practitioners, outreach and sustainability has been deepened to verify the existence of trade-offs between economic and financial objectives (financial sustainability) with social objectives (outreach performance). Evidence of a trade-off between



outreach and sustainability is the hefty debate on this issue between the welfarists, the disseminate dominance outreach purposes ([Woller & Schreiner, 2000](#); [Robinson, 2001](#); [Montgomery & Weiss, 2005](#); [Hashemi & Rosenberg, 2006](#)), and institutionalist who stressed the importance of sustainability ([Rhyne, 1998](#); [Christen, 2001](#); [Isern & Porteous, 2005](#)).

Several studies on the relationship in outreach with sustainability already done such, a study conducted by [Christen et al. \(1995\)](#) on the performance of sustainability and outreach concluded that the positive effect of MFI on the socio-economic welfare of the poor can only be maintained if the MFI have good financial performance and outreach. [Cull et al. \(2007\)](#) empirically examine the trade-off between depth of outreach and micro-profit institutions. The result is an MFI that generate individual loans have better performing to profitability but the fraction of borrowers who are poor and destitute women in the loan portfolio is lower than the institutions that offer loans group. This study provides evidence of a trade-off between sustainability and outreach and important emphasis on institutions to design and determine the presence and size of the trade-offs.

[Kar \(2011\)](#) shows that microfinance institutions can still achieve sustainability without increasing the average loan size or interest earnings. In his research explained that the implementation of the policy interest rate is better, solidarity group loans methods and an increase in scale with the increasing breadth of outreach achievement assist the process of achieving sustainability. [Makame and Murinde \(2006\)](#) analyze the trade-off between outreach and sustainability, found strong evidence for a trade-off between outreach and sustainability through efficiency. In contrast, ([Gonzalez & Rosenberg, 2006](#)) found that it seems there is no conflict between maintaining financial sustainability and outreach.

In its development, sustainability studies has included a variety of areas due to transformation and commercialization of microfinance has brought MFIs become more complex. there has been a shift in focus from subsidies into financial sustainability and efficiency of the institution. The development of microfinance business has faced tight competition, risk and needs funding sources. In addition, the need for information technology and government policy strongly supports the achievement of sustainability of MFIs.

[Qayyum and Ahmad \(2006\)](#); [Nawaz \(2010\)](#); [Kablan \(2012\)](#); [Nadiya et al. \(2012\)](#) have seen the importance of efficiency, but [Qayyum and Ahmad \(2006\)](#) did not find evidence of this as [Nawaz \(2010\)](#); [Nadiya et al. \(2012\)](#) who found a positive relationship between efficient and sustainable. meanwhile, [Kablan \(2012\)](#) confirm an increase in financial efficiency but has reduced social efficiency.

From the perspective of policy-making is very important to know whether sustainability can be achieved. Regulations allow microfinance institutions to take deposits and extend their banking functions. [Cull et al. \(2011\)](#) find evidence that microfinance institutions profit-oriented response to supervision by maintaining the level of profits, but limiting the outreach of women and expensive customer. Institutions with weak commercial focus instead tend to reduce profitability but keep outreach. Meanwhile, take deposits from the public and access to market funding will increase the risk of the institution ([Arvelo et al., 2008](#)).

[KAI \(2009\)](#) has focused competition and its relationship with sustainability and find that the competition does not have an impact on sustainability. Another case with [Islam et al. \(2014\)](#) and [Bogan \(2012\)](#) who see the importance of cost structure and capital structure with sustainability as a result of access to market funding. [Islam et al. \(2014\)](#) states that only the general administration costs and the impact on ROA [Bogan \(2012\)](#) found mixed results, assets berpengaruh positive significant OSS and FSS. Grants, equity, debt significant negative effect on OSS and FSS.

Currently, the development of micro-finance topic has been associated with corporate governance needs and information technologists. The Principles of corporate governance has become a new focus of academics in microfinance, especially when dealing with the topic of long-term financial sustainability. Many scholars stated that the new banking technologies, such as credit cards, ATM, mobile phones, and the internet has entered the microfinance business, helping to increase outreach and reduce costs ([Rhyne & Otero, 2006](#); [Kapoor et al., 2007](#)).

In the beginning, [Hartarska \(2005\)](#) found that not all governance mechanisms affect performance, and different factors showed different effects on sustainability. Furthermore, [Kyereboah-Coleman and Osei \(2008\)](#) proved that governance has played an important role in the performance of MFIs, and board independence has a positive correlation to performance. While, [Mersland and Strøm \(2009\)](#) Mersland and Strom, (2009) showed that financial performance increased with the leadership of the local director than foreign directors, internal agency auditors, and CEO of women and regulation has no effect on performance.

## 6. Conclusion and suggestion

This literature review was conducted to see the development of sustainability research and variables that influence it. Since the early 1990s, the study on sustainability in microfinance has been associated with outreach. Most of them is to verify the trade-off between outreach and sustainability. The next stage, in line with the transformation of microfinance, sustainability research has seen other variables that affect it such as efficiency, regulation, competition, commercialization, risk, capital structure, cost structure, IT and corporate governance.

However, research on the sustainability of microfinance still leaves a lot of questions and empirical studies. There are still a lot of space for improvement and refinement of research on the sustainability of microfinance. Some suggestions from previous studies stated that corporate governance is a critical issue for the success of microfinance institutions ([Campion, 1998](#); [Rock et al., 1998](#)) but only a few studies on the issue of corporate governance in microfinance ([McGuire, 1999](#); [Lapie, 2001](#)). While, [Kauffman and Riggins \(2012\)](#) stated that ICT is the initiator of the new environment and potential solutions for MFIs to survive. [Kauffman and Riggins \(2012\)](#) proposed the direction of future research on the role and impact of ICT in the microfinance industry.

### References

- Aboagye, Anthony Q., & Otioku, James. (2010). Are Ghanaian MFIs' performance associated with corporate governance? *Corporate Governance*, 10(3), 307 - 320. doi: 10.1108/14720701011051938
- Arvelo, Miguel, Bell, Ju-Lie, Novak, Christian, Rose, Juliette, Venugopal, Shally, & Stanley, Morgan. (2008). Morgan Stanley's Approach to Assessing Credit Risks in the Microfinance Industry. *Journal of Applied Corporate Finance*, 20(1).
- Babandi, Gumel Gambo. (2011). Micro Finance Institutions in Nigeria Outreach and Sustainability: Questionnaire Survey Findings. *International Journal of Business and Social Science*, 2(9), 126-129.
- Bogan, Vicki L. (2012). Capital Structure and Sustainability- An Empirical Study of Microfinance Institution *The Review of Economics and Statistics*, 94(4), 1045-1058. doi: 10.1162/REST\_a\_00223
- Campion, Anita. (1998). *Current Governance Practices of Microfinance Institutions* (Vol. 3). Washington, DC: The Microfinance Network.
- Christen, Robert Peck. (2001). Commercialization and Mission Drift: the Transformation of Microfinance in Latin America. *Occasional Paper CGAP*, 5.
- Christen, Robert Peck, Rhyne, Elisabeth, Vogel, Robert C, & R, McKean. (1995). Maximizing the Outreach of Microenterprise Finance: an analysis of Successful Micro finance programs *Program and Operations Assessment Report* (Vol. 10). Washington D.C USAID.
- Cull, Robert, Demirgüç-Kunt, Asli, & Morduch, Jonathan. (2011). Does Regulatory Supervision Curtail Microfinance Profitability and Outreach? *World Development* 39(6), 949-965. doi: 10.1016/j.worlddev.2009.10.016
- Cull, Robert, Demirgüç-Kunt, Asli, & Morduch, Jonathan. (2007). Financial Performance and Outreach: A Global Analysis of Leading Microbanks. *Economic Journal* 117(517), 107-133.
- Gonzalez, Adrian, & Rosenberg, Richard. (2006). The State of Microfinance – Outreach, Profitability, and Poverty: Findings from a database of 2600 microfinance institutions.
- Hartarska, Valentina. (2005). Governance and Performance of Microfinance Institutions in Central and Eastern Europe and the Newly Independent States. *World Development* 33(10), 1627-1643. doi: 10.1016/j.worlddev.2005.06.001
- Hashemi, Syed, & Rosenberg, Richard. (2006). *Graduating The Poorest Into Microfinance: Linking Safety Nets and Financial Services* (Vol. 34).
- Helms, Brigit. (2006). *Access for All: Building Inclusive Financial Systems*. Consultative Group to Assist the Poor (CGAP): World Bank.



- Isern, Jennifer, & Porteous, David. (2005). *Commercial Banks And Microfinance: Evolving Models of Success* (Vol. 28).
- Islam, Zahid, Porporato, Marcela, & Waweru, Nelson. (2014). Cost Structure and Financial Sustainability of Microfinance Institutions. *International Journal of Financial Services Management.*, 7(1), 54-72.
- Kablan, Sandrine. (2012). Microfinance efficiency in the West African economic and monetary union: have reforms promoted sustainability or outreach? *Working Paper-025*.
- KAI, Hisako. (2009). Competition and Wide Outreach of Microfinance Institutions. *Munich Personal RePEc Archive (MPRA) Paper*, 17143(7).
- Kapoor, Mudit, Morduch, Jonathan, & Ravi, Shamika. (2007). From Microfinance to m-Finance. *Innovations: Technology, Governance, Globalization*, 2(1-2), 82-90.
- Kar, Ashim Kumar. (2011). Microfinance Institutions: a Cross-Country Empirical Investigation of outreach and sustainability. *Journal of Small Business and entrepreneurship*, 24(3), 427-446.
- Kauffman, Robert J., & Riggins, Frederick J. (2012). Information and communication technology and the sustainability of microfinanc. *Electronic Commerce Research and Applications*, 11, 450–468. doi: 10.1016/j.elerap.2012.03.001
- Kyereboah-Coleman, Anthony, & Osei, Kofi A. (2008). Outreach and profitability of microfinance institutions: the role of governance  
*Journal of Economic Studies*, 35(3), 236 - 248. doi: 10.1108/01443580810887797
- Labie, Marc. (2001). Corporate governance in microfinance organizations: along and winding road. *Management Decision*, 39 (4), 296 - 302. doi: 10.1108/00251740110391466
- Ledgerwood, Joanna. (2008). *Microfinance Handbook : An Institutional and Financial Perspective-Sustainable Banking With The Poor*. Washington, D.C.: The World Bank.
- Ledgerwood, Joanna. (2013). *The New Microfinance Handbook: A Financial Market System Perspective: The World Bank*, Washington, D.C.
- Makame, A H, & Murinde. (2006). Empirical Findings on Cognitive Dissonance Around Microfinance Outreach and Sustainability. *Unpublished paper, Birmingham, University of Birmingham*.
- McGuire, Paul B. (1999). Policy and Regulator for Sustainable Microfinance: Country Experiences in Asia. *Journal of International Development*, 11, 717-729.
- Mersland, Roy, & Strøm, R. Øystein. (2009). Performance and governance in microfinance institutions. *Journal of Banking & Finance*, 33, 662–669. doi: 10.1016/j.jbankfin.2008.11.009
- Montgomery, Heather, & Weiss, John. (2005). Great Expectations: Microfinance and Poverty Reduction in Asia and Latin America. *ADB Institute Research Paper Series*, 63.
- Nadiya, M, Olivares-Polanco, Francisco, & Ramanan, T Radha. (2012). Dangers in Mismanaging the Factors Affecting the Operational Self-Sustainability (OSS) of Indian Microfinance Institutions (MFIs)-An Exploration into Indian Microfinance Crisis. *Asian Economic and Financial Review*, 2(3), 448-462.
- Nawaz, Ahmad. (2010). Issues in subsidies and sustainability of microfinance: An empirical investigation. *Working papers CEB*, 10.
- Paxton, Julia, & Fruman, Cecile. (1997). *Sustainable Banking with the Poor*. Washington D C, USA: World Bank.
- Qayyum, Abdul, & Ahmad, Munir. (2006). Efficiency and Sustainability of Micro Finance Institutions in South Asia. *MPRA Paper*, 11674(21).
- Rhyne, Elisabeth. (1998). The Yin and Yang of Microfinance: Reaching the Poor and Sustainability. *Micro banking*, 6-9.
- Rhyne, Elisabeth, & Otero, María. (2006). *Microfinance through the Next Decade: Visioning the Who, What, Where, When and How*. Paper presented at the The Global Microcredit Summit 2006, Boston USA.

- Robinson, Marguerite S. (2001). *The Microfinance Revolution: Sustainable Finance for the Poor* (Vol. 1): Word Bank.
- Robinson, Marguerite S. (2002). *The Microfinance Revolution: Lessons from Indonesia* (Vol. 2): Word Bank.
- Rock, Rachel, Otero, Maria, & Saltzman, Sonia. (1998). *Principles and Practices of Microfinance Governance*. Washington, DC: ACCION International.
- Torre, Mario La, & Vento, Gianfranco A. (2006). *Microfinance*. British Library: Palgrave Macmillan Studies in Banking and Financial Institutions.
- Woller, Gary, & Schreiner, Mark. (2000). *Poverty Lending, Financial Self-Sufficiency, and The Six Aspects Of Outreach*.

## Development Model of Small and Medium Skills and Cluster Based Economy in The Province of Aceh

<sup>1</sup>Ikramuddin, <sup>2</sup>Mariyudi, <sup>3</sup>Naufal Bachri, & <sup>4</sup>Rasyidin

<sup>1</sup>Ph.D Student at Management Science of Syiah Kuala University, Aceh-Indonesia,  
Email: [ikram\\_alueraya@yahoo.com](mailto:ikram_alueraya@yahoo.com), HP. +6285260136908

<sup>2</sup>Doctor of Philosophy College of Business Universiti Utara Malaysia,  
Email: [mariyudy@yahoo.com](mailto:mariyudy@yahoo.com), HP. +6285260566667

<sup>3</sup>Ph.D Student at Management Science of Syiah Kuala University, Aceh-Indonesia,  
Email: [naufal.sembe@gmail.com](mailto:naufal.sembe@gmail.com), HP. +6285277276001

<sup>4</sup>Faculty of Social and Politics Science, Malikussaleh University  
Email: [rashid\\_unimal@yahoo.co.id](mailto:rashid_unimal@yahoo.co.id), HP. +6281269591961

### Abstract

The purpose of this study is to identify the model of development of small and medium enterprises. It based on the skills and clusters economy in the Province of Aceh. The areas of the research are Sabang, Aceh Besar, Banda Aceh, Pidie, Lhokseumawe and Langsa. The units of analysis are managers of small and medium enterprises in those regions. Data analysis method uses a descriptive statistical analysis, base sector analysis, shift-share analysis, and specialized regional analysis. The results showed that the agriculture-based businesses emerged as a high growth potential sector. The addition of the value of products produced by providing the skills expected to help perpetrators of micro and small-scale production to increase their incomes so that poverty and child labor can be effectively tackled. The study recommends the establishment of a network of skills training providers and policy makers to the effectiveness of coordination, preparation and implementation of competency standards for basic strategic skills and the introduction of skills and expertise from outside of Aceh with the help of donors.

**Keywords:** *models, development, economic clusters, small and medium enterprises, Aceh*

## 1 Introduction

Each area challenged to improve to face the era of competition which is not only local but also in a global nature. This competition requires each nation, states and regions to be improved by creating the most conducive environment in businesses. In this constellation, Indonesia launched a decentralization policy that substantially redefines the role of the Central Government and Local Government in administrative and fiscal functions.

Urban areas in Indonesia, as well as urban in the third world, many found the development of small industries as a result of the inability of the government to overcome the problem of unemployment and poverty. Some small industrial activities even included in the informal sector. But their presence has not received a serious attention from the government, though the small and medium industrial sector have a significant contribution for the problem of the unemployment and economic problems of urban areas. The ILO reported that 60% of workers in the cities of developing countries are absorbed by the informal sector and activity in small and medium enterprises (SMEs). It was also reported that the role of the SME sector is very important for being able to create markets, expand trade, manage natural resources, reduce poverty, create jobs, build community and support their families without control and facilities of adequate local authorities (ILO, 1991 and Reddy et al, 2002). In Indonesia, the SME sectors even become the foundation of life of the greater since the economic crisis that began in 1997 (Sarosa, 2000)

On December 26, 2004, a powerful earthquake on 9.1 the Richter scale devastated Aceh province. The series of giant tidal wave (tsunami) that followed resulted in tremendous surge of water rolled and killed 221.005 inhabitants. Many people lost their livelihoods because of production facilities and infrastructure were destroyed or severely damaged. Helps came flowing and various reconstruction projects started to rebuild the region. Various measures taken by the Government of Aceh Province to make the economic growth in the region to be better and to rise from adversity, one

alternative solution is the application of the concept of community economy based on small and medium businesses.

This study aims to support the economic development in Aceh and poverty reduction by facilitating the transition from stage to stage of reconstruction and rehabilitation of sustainable growth. According to CBS, in 2008 the poverty rate in Aceh reached 23.5 percent; this figure is much higher than the national average of 15.4 percent. The increase in agricultural output reduces poverty rate of 28.4 percent in 2004 to 23.4 percent in 2008 (BRR NAD-NIAS: 2009).

This study is intended to contribute to the realization of the ideals of revitalizing local economy and realizing the prosperity of Aceh through skills development. Although the focus of this study lies on the development of skills, this study relies heavily on the economic and policy analysis to forecast demand for skills.

## **2. Literature Review**

### **2.1 Definition of Small Enterprises**

Central Bureau of Statistics defines Micro as a business which has employees more than 4 people. While the Small Enterprises mentioned in Law number 9 of 1995 is a small-scale productive enterprises and has the criteria of maximum net worth around Rp.200.000.000,00, excluding land and building or has income Rp.1,000,000,000.00 per year and can receive a maximum credit from bank above Rp.50,000,000,- 500.000.000,-. World Bank defines Small Enterprises in some criteria: The number of employees less than 30 persons; Yearly income does not exceed \$ 3 million; Total assets do not exceed \$ 3 million.

However, the latest term about the Small Enterprises by Law No. 20 of 2008 is an independent productive economic activities, which is done individual or business entity that is not a subsidiary or branch of company, controlled, or be a part either directly or indirectly of a medium or large business that have a net worth of more than Rp.50,000,000.00 up to Rp. 500,000,000.00 which is not including land and buildings; or have the annual sales more than Rp.300.000.000,00 up to Rp2.500.000.000,00.

### **2.2 Definition of Medium Enterprise**

According to the Central Bureau of Statistics is a business which has employee around 20 until 99 people. While refers to the Instructions of President No.10 of 1998 is a productive businesses that that have criteria of greater net wealth from Rp.200.000.000,00 up to the maximum amount of Rp.10.000.000.000,00, excluding land and buildings, and can receive credit from the bank for Rp.500.000.000,00 - Rp.5.000.000.000,00. World Bank defines Medium or Medium Enterprise is a business with criteria: Number of employees a maximum of 300 people; the revenue in a year is up to \$ 15 million; Total assets up to a \$ 15 million

While the definition of Medium Enterprise according to Law No. 20 of 2008 is an independent productive economic activities which is done by the individual or business entity that is not a subsidiary or branch of company, controlled, or be a part either directly or indirectly by Small Enterprise or large business that has a net worth more than Rp.500.000.000,- Rp.10.000.000.000, excluding land and buildings; or have annual sales more than Rp2.500.000.000,- Rp.50.000.000.000. (Bank Indonesia; <http://infoukm.wordpress.com>).

### **2.3 Definition of Skills**

Skills derived from the word "Skillful". In Indonesian Dictionary (2001: 1180) is skill in completing the task. Thus, it can be concluded that skill is the ability of a child to perform various activities in completing the task. Skills need to be trained to the children early so that they will grow up to be skilled and efficient in doing all the activities, and able to deal with the problems of life. In addition, they will have the skills that will be beneficial for the community.

According to Schmidt in Amung Ma'mun and Yudha (2000: 61), skill is the ability to make the maximum and certainty of final result, but by spending a minimum of energy and time. According Soemarjadi (2001: 2) states that the skill is the same with "adroit". Skillful or adroit is the intelligence to do any work quickly and correctly. However, in the narrow sense, skills tend to be claimed at toward the activities such as deeds. Skilled is more than just an understanding. Therefore, becoming a skilled need many practical exercises that can provide a stimulus in the brain, so that we are more accustomed. Skills means the ability to use the mind or reason, while an efficient and effective action achieves a particular outcome, including creativity. Skills contain some element of ability such as the ability of thought (psychic) and the ability of action (physical) (Subana & Sunarti, 2000: 36; Yudha & Rudhyanto, 2005: 7)

## **2.4 Definition of Economic Cluster**

In detail, there are several definitions of Cluster. Porter (1990) defines it as "Cluster is geographic concentration of firms, suppliers, related industries, and special institutions that occur in a particular field in a nation, state, or city." Another definition of Clusters industry is "the geographical concentration of industries that gain performance advantages through co-location" (Doeringer & Terkla 1995). While Rosenfeld (1995) adds definitions that Clusters is "the relationship between the company which also provides various complementary services, including consultancy services, education and training providers, financial institutions, professional associations and government institutions.

Niven and Droge (2000) argues that there are at least three forms of Cluster framework: Diamond models, flexible specialization and collective efficiency. Flexible models and specialization widely adopted by developing countries. Porter diamond models widely applied in developed countries. Model diamond is considered more superior than the other models in explaining Dynamic Clusters and have a great role in improving productivity through industrialization process.

Approach of Cluster Porter model is the development of industrial district or industrial areas developed by Alfred Marshall in 1920 (Desrochers and Sautet, 2004). In contrast to Marshall who only focuses on the same companies, Cluster Porters model does not restrict only one industry, but also for more broadly. Diamond Cluster Model, includes related industries, as well as the other companies that have relevance in technology and have the same input.

## **3 Method of Analisis Data**

This study conducted to the local economy in order to forecast the demand / need toward Skills driven by market, such as by looking at the characteristics of the provincial economy, the trend of growth in the sectors of economy. The scope and depth of the analysis is restricted to the areas mentioned, like by thinking the aim of demand / need for skills. Then, the study analyzes the demand / need for skills arising from the Medium Term Development Planning.

To analyze the demand / need for skills in the community, this study uses the mechanism of Observation to the Community or Community Employment Assessment (CEA) developed by the Training for Rural Economic Empowerment (TREE). Since the demand of these skills rarely appear in the statistics and macro levels of policy document, the interaction with the local community becomes important in order to gain an understanding of it.

### **3.1 The analysis of Descriptive Statistic**

The descriptive analysis is used to describe a variety of conditions and developments from time to time and updated from various indicators that will be required. A description will be displayed either in the form of tables, images / graphics, or a general explanation to facilitate the general reader in understanding of the data or information provided in writing.

### **3.2 Community Employment Assessment (CEA)**

CEA method uses statistic descriptive understanding in describing the characteristic of labor market which influences the improvement of skills. Because the demand for skills analysis starts from the economic growth which is based on the sector, the labor market analysis also focused on the employment, wages and labor productivity which based on the sector. The analysis also examines the educational attainment of the labor force until a certain time and education also determines the skills of workforce. The focus group discussions and interviews have been conducted to collect the qualitative information from the principal stakeholders.

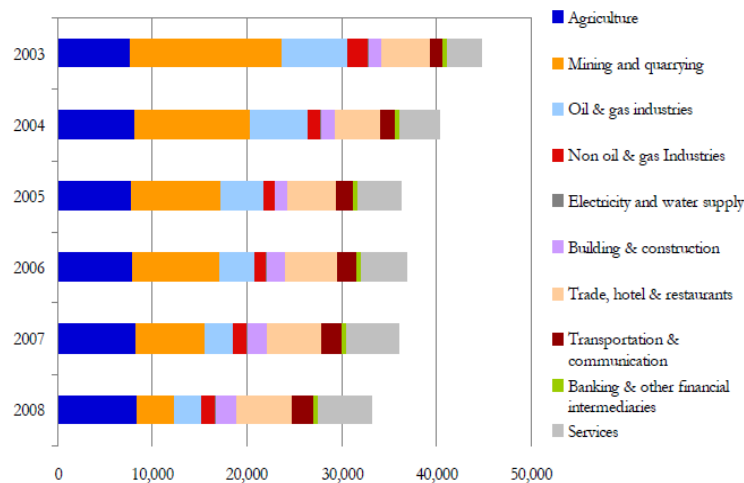
This study analyzes the labor market to get the signs of demand for skills in the future in Aceh. According to Sparreboom and Powell, a set of labor market indicators mentioned below show the demand for skills (Sparreboom & Powell, 2009: 4): Trends in employment (by position, sector, employment status and geographic region); unemployment trends, Trend and educational attainment development of skills in the workforce, wage trends, productivity trend, and contribution to GDP based on various economic sectors/geographic areas.

## **4. Results and Discussion**

### **4.1 Prospect of Local Economic sector**

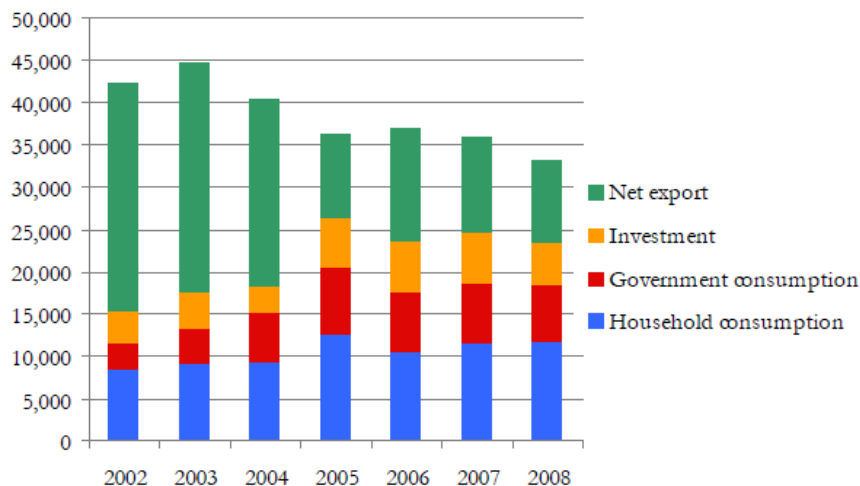
As a result of the shrinking of the gas deposits, regional gross domestic product decreased (see Figure 1). Although the last oil and gas output has more than half of local output, the portion of these commodities in PDBD reduced to 19.3 percent in 2008. As a result, the related sectors of oil and gas face the same fate. Figure 1 reveals that the oil and gas industry lost about 58.6 percent of its

output around 2003 and 2008. The oil and gas sector support the local economy by creating a related businesses such as fertilizer and cement. The output of these sectors includes two products that had been mentioned was reduced from 1.672 billion dollars in 2002 to 944 billion dollars. Because the product of mineral fuels and mineral oils include 96.6 percent of the value of commodity exports in Aceh in 2007, net exports incredibly decreased (see Figure 1).



**Figure 1:** PDBD in Aceh by industrial origin (in billions rupiah, constant price is 2000)  
Source: BPS-Statistics Aceh

Another factor affecting the economy of Aceh is a gradual departure of aid agencies including the Rehabilitation and Reconstruction Agency for Aceh and Nias (BRR NAD-NIAS), international organizations and NGOs. The Capital flows into Aceh after tsunami in 2004 for projects of reconstruction and rehabilitation. In November 2006, funds from the domestic, private donors and NGOs were allocated to these projects totaled around \$ 5.8 billion. The allocation of these funds is quite large when they are compared with PDBD Aceh, including oil and gas to the year of 2006 which is about \$ 7.4 billion US. The total funds injected to such projects in Aceh and Nias is estimated at eight billion dollars US.



**Gambar 2:** PDBD in Aceh based on the outcome (in billion rupiah, constan cost is 2000)

**Sumber:** Indonesia Bank and Estimation of BPS

## 4.2 Study on Employment in the Community

The types of training that is necessary for the local community may not be the same as the types of training that was developed to the formal sectors of employment and are developed based on the results of macro analysis of the demand for skills at the central level. The researchers have conducted a study on employment in the community in six municipalities / districts in Aceh, those are: Sabang, Banda Aceh, Aceh Besar, Pidie, Lhokseumawe and Langsa. Based on the results of surveys

and meetings with the public as mentioned above, each group of people who participate in this assessment proposed the types of skills training that will benefit to young people who do not attend the school in their communities.

Many communities said that sewing skills assessed as the required skills. The fact shows that at least one of six vocational training proposals is sewing training and of course there are demands on these skills because the clothes ordered are often cheaper than apparel. However, the perception of the magnitude of demand for sewing skills might be affected by gender biases in employment and the conveniences in conducting training because of the equipment, tools and instructors needed are available. Generally, the shift from skills training driven by offering to the skills training which led by a demand which needs the development capacity of training providers.

Communities do not indicate a strong demand for skills production and food processing. This result is rather different from the findings of potential policy analysis and development of economic and also the perspective of political leaders and the business / enterprise. This may reflect the constraints of availability of the equipment and skills and also lack of awareness of the food processing business opportunities. However, the local people survey and capture changes in taste and see the business opportunity of making bread and cakes.

Types of traditional skills such as manufacturing furniture and handicrafts are also in the list even though the demand of these types of skills seems rather weak comparing to the demand of modern skills. Almost half of the skills training proposals are about training in manufacturing of furniture. Because the population is expected to increase, the number of households will follow the same trend and demand for furniture will increase constantly.

### 4.3 Analysis of labor market

Aceh has a labor force for about 1.9 million people; according to the data collected until February 2009, there are 1.7 million of them are working. The unemployment rate reached 9.3 percent in Aceh; substantially, it higher than the national average rate about 8.1 percent. Between 2005 and 2008, the labor forces in Aceh are recorded growth around 1.7 percent. Providing and fostering work opportunities as balance as the rate of labor force growth is a challenge in Aceh. This challenge is realized when the projects of reconstruction and rehabilitation gradually closed. For example, the employments through the activities carried out by non-governmental organizations are reduced from 7,000 to 2,000 which causes 5,000 highly educated workers become jobless. In addition, the history of a prolonged conflict between the armed forces and GAM (Separatism Organization in Aceh) which still leaves the problems in the labor market in Aceh: there are a lot of GAM combatants around 12,400 and 6,500 of them are still unemployed.

The lack of woman participation in labor market in Indonesia is shown in all sectors of economy; this reflects a culture of biases gender. The trade, restaurants and hotels in Aceh employ women less than another province in Indonesia. Overall, the number of women working in Aceh is still low, around 25.3 percent comparing with the entire places in Indonesia which have 27.4 percent women participation..

**Table 1: Employment Based on sector and gender (in percent)**

Sector	Portion of Employment sector (Total gender)		Women contribution in employment	
	Aceh	National	Aceh	National
Agriculture, forestry and fishery	48.5	40.3	25.9	27.2
Mining and quarrying	0.5	1.0	7.4	11.0
Manufacturing industry	5.3	12.2	34.5	30.2
Electricity, gas and water	0.2	0.2	6.6	7.9
Construction	6.4	5.3	1.4	2.3
Trade, restaurants and hotels	15.6	20.7	25.7	33.5
Transportation, warehousing and communications	5.5	6.0	9.7	10.4
Financial services, insurance, real estate and business	0.6	1.4	21.8	22.8
Social Service, social and individual	17.4	12.8	31.1	30.3
<b>Total</b>	<b>100.0</b>	<b>100.0</b>	<b>25.3</b>	<b>27.4</b>

: Survey of labor force, BPS

**Table 2: Growth of employment and output**

Sector	Output growth 2007-08 (%)	Employment Growth 2007-08 (%)	Employment sector	Output per Employment
Agriculture	2.0	-6.5	786,198	10.6
Mining and Quarrying	-34.2	-36.2	8,660	462.6
Manufacturing industry	-7.2	9.7	86,762	49.6
Electricity and water	18.1	22.2	2,691	34.4
Building & construction	6.3	12.9	103,816	20.5
Trade, hotels and restaurants	3.1	7.4	252,853	23.4
Transport and Communications	6.1	6.9	88,842	24.4
Banking and other financial intermediaries	5.6	59.3	9,427	58.4
other financial Service	7.6	6.9	282,749	19.6
<b>Total</b>	<b>-5.3</b>	<b>-0.1</b>	<b>1,621,998</b>	<b>20.4</b>

Source: BPS, author's calculations

\*: million rupiah, Constant cost of 2000

#### 4.4 Small and Micro Enterprise and the use of workforce

Based on the enterprise views, micro and small enterprises (MSEs) are the backbone of the local economy and the user of labor force. The growth of MSE and its capacity in creating jobs is crucial for the local economy. Therefore, the government needs to work towards a conducive business environment for MSE. Although the growth of manufacturing sector has lost the momentum in Aceh, in 2007 there are 92 large industrial enterprises and medium scale operating in Aceh (see Table 3). Nearly 40 percent of these businesses are active in the food and beverage industry

These enterprises can employ almost five thousand workers. The Segment of this economy can grow if the government of Aceh effectively solves the problems faced by the potential investors and try to increase the value of local agricultural products. Some of the businesses which depend on the oil and gas industry are still operating, but they face the declining due to the gas deposits. Textile and garment industry is known because of their intensive production processes, but their contributions in employing are still less toward the employment.

**Table 3: Number of Production Site And Employment In Large and Medium Scale Manufacturing Industry In Aceh**

Type of Industry	Total Production sites	Total Employees
Food, beverages and tobacco	37	4,946
Chemical products, oil, coal, rubber and plastic	9	1,605
Paper and processed products, printing and publishing	2	1,151
Textile, garment and leather	12	637
Nonmetallic mineral products, except processed / oil and coal products	16	532
Processed metal products, machinery and equipment	10	476
Wood, bamboo, rattan, palm etc., Including furniture	6	199



Source: BPS-Statistics Aceh

#### 4.5 Offers on skills training

The results show about the offers on skills training in three districts as samples in Aceh. Truly, the statistics below do not necessarily reflect the whole situation of the offers on skills training in Aceh. Therefore, in analyzing this section should be cautious in their assessments. Nevertheless, some parts of Aceh used as sample are great and wide; In addition, the statistics and maps of skills training illustrate the offers on skills in Aceh; this information is sufficient to allow a gap analysis.

The Largest skills training provider is the private institutions such as non-formal education institutions and NGOs. In fact, the number of instructors and trainees are still greater than in government institutions (Table 4). Make over clothing and embroidery are the most common subjects offered in the vocational training. Every year nearly 2,000 people learn sewing in many private training institutions, which cover 31.1 percent of capacity training in the districts sampled (Table 5). Training about carpentry and mechanical repair are the second most commonly offered. For this type of training, training institutions, government and private training institutions have almost the same capacity in terms of the number of instructors and trainees, although the quality and training tools used may not be comparable. Most of (58.9 percent) skills training take place in the classroom. A quarter of the existing training combines classroom learning with job training or on-the-job training (Table 4).

**Table 4: Training Capacity based on the type of training providers**

Training Providers	Total instructors	Training Capacity
Government agencies	200	1050
Private institutions	605	5020
A combination of both	7	260

Source: PKPA

**Table 5: Training Capacity based on the category and type of organizer**

Training Categories	Government agencies	Private institutions	Combination	Total (%)
Agriculture, fisheries and livestock	30	922	120	1072 (16.9)
Food processing	60	397	140	597 (9.4)
Make clothes and embroidery	0	1969	0	1969 (31.1)
Reparations and mechanical	770	785	0	1555 (24.6)
Computer skills	20	277	0	297 (4.7)
Crafts & manufacture of furniture	170	565	0	735 (11.6)
Carpentry in timber	0	50	0	50 (0.8)
Beauty salon	0	55	0	55 (0.9)

Source: PKPA

#### 4.6 Analysis of Skill Gap

This section examines the gap between current skills training provided / offered and demand / need for skills that exist today and in the future in Aceh based on the information and analysis of the previous section. This section matches the information from the table with the offers on skills training, as illustrated in the previous section.

The analysis reveals that the strengthen of the value of local agricultural and marine products through the application of skills in the field of processing, packaging and marketing of food are very useful to increase the scale / size of the economy in a sustainable manner. However, in the districts sampled, skills training in food processing is still very little. Skills in the field of packing / packaging, marketing, and training skills in the field of food hygiene, quality control and food additives, are not developed systematically yet. This should be considered by the policy makers and stakeholders.

Training skills that can improve the agrarian economy still less. Although the expertise in agriculture, forestry and fisheries can be taught by more experienced workers to workers who are relatively young and inexperienced in the workplace, however, it is still needed training to improve productivity (e.g. for a better use of fertilizers, agricultural engineering / more effective farm, and the improvement of the quality of agricultural products / livestock).

The financial sector recorded a rapid expansion / extension of the efforts in this sector in the last decade. Therefore, the demand for skills in this sector is quite high. However, because banks typically only provide training to employees themselves, then there is only limited financing need or maybe there is no need for the external actors to offer skills training to the banking sector. However, it should be given more training on knowledge in the finance to the Micro enterprises owners and the entrepreneurs. Microfinance institutions may require the capacity building in order to operate more efficiently and can provide more oriented services to the client.

Embroidery and sewing skills training are relatively much offered in the area. Perhaps because Aceh has only twelve textile and garment companies which employ a total of medium scale 600 to 700 workers, there are still plenty spaces for micro to operate in the industry. In addition, local consumers tend to buy clothes of tailor-made because less expensive than the ready-made apparel. Embroidery and sewing skills training help women earn the extra income for the family / household. Nonetheless, it should be reviewed on the balance between supply and the demand for this kind of skills in Aceh.

Although computer skills training are provided, the other conducive skills training are not able to fill the demand on skills training needed in the job market. Because the micro and small enterprise are the backbone of the economy and most recruitment are in those enterprise, efforts in encouraging and facilitating the entrepreneurship and encouraging improvements in the productivity should be made integral policy of development skills in Aceh. The offers on skill trainings seem less than optimal for stimulating the growth and development on small-scale enterprises.

## **5. Conclusion**

1. This study analyzes the skills gap in Aceh from the perspective of how the dig up the potential of sustainable economic growth. This paper examines the economic sector, development plans and the demand for skills at the community level in order to gain an understanding of the demand for skills in the future. Labor market analysis and qualitative research complete the analysis of the demand for such skills. The paper then compares the expected demand for skills by offering skills training available today to identify the gaps are tend most in to the intervention in the skills development policies
2. Increasing the value of agricultural and marine products is very important to improve income in a sustainable manner. In fact, Aceh has fertile land and rich sea marine resources. Therefore, this paper emphasizes about the importance of skills in the field of processing, packaging and marketing food. However, the offers on skills training in these areas are still less than necessary.
3. Well educated labor forces are the extra assets of Aceh. Because of the development of enterprises encourage a new employment, so, fostering a conducive business environment brings a multiple benefit. Skills training can play a role in chasing this thing. Therefore, it needs to organize the skills training in entrepreneurship and in any other business areas.
4. The demand / need for skills or the offer on skills need to be reviewed periodically. If there is an excess offer, then the resources can be reallocated to the areas of strategic skills training. The migration of young labor educated in engineering from Aceh to the other provinces is a sign of a mismatch between offer and demand for skills in the province.
5. The purpose of this study is to contribute on the formulation of the better policies of development skills in Aceh. Standard of competence is absolutely helpful in guiding the development of skills. Stakeholder networks facilitate the process of policy formulation and the effective implementation. Further research and more detail is needed to generate a contributed knowledge to support the reform of training skill in Aceh.

## **6 Rekomendation**

This part introduces some ideas and policy options that help in narrowing the gaps that have been identified in the previous part. it will provide a conducive environment for the achievement of the policy objectives of regional development and also to increase the income of local producers. Poverty reduction will reduce the exploitation of child labor and thus, it can be effectively stop the chain of poverty. This study emphasizes about the need to fill the skills gap related to the agribusiness because a higher productivity in the agricultural sector can reduce the exploitation of natural resources and can facilitate the efforts in improving livelihoods

1. Improving the skills training provider networks and policy makers for an effective coordination and facilitation. It is important to note that the development of skills may serve as a catalyst for regional development. Skills training provided or offered, as discussed in the previous section are not in line with the needs of the strategic skills to that area. A better coordination between the policymakers and skills training providers will help to maximize synergizing and increasing the impact of policies on regional development skills training and poverty reduction. The policy makers and skills training providers should have the same understanding of areas that require additional skills training and have a common vision of development goals and strategies that will be pursued to achieve the goal. Therefore this paper suggests that the common understanding and vision are combined by increasing the role of coordination agency that handles skills development, namely; Training Development Agency. This agency should renew the list of skill training, review and examine practically in order to solve the gap
2. Developing and implementing the standards for basic skills that are strategic. Standard requires skills development that can be used as an official benchmark for providers of vocational training and formal reference to the quality of training. Once the Board of Trustees of selecting strategic skills for sustainable regional development and poverty alleviation, probably one of the first tasks that need to be done is to develop new competencies description or review the description of competencies that exist today for these skills.
3. Obtaining the skills and expertise through external aid, is expected to help the donor. Advances in technology and knowledge needed to produce the product (goods) and services that meet international quality standards. The human Resources are not always available in Aceh at this current stage of development. The Cooperatives of producers and skills training providers may wish to invite experts from outside the area to organize training workshops. At the same time, strategic and focused dialogue with donors to encourage the transfer of relevant technologies and ultimately facilitate the absorption of the skills needed by local manufacturers.
4. Fostering the entrepreneurship and business environment in the service sector. Strategically, it is important to facilitate the growth in this sector in order to serve the demand that arises from and to accelerate the expansion of agribusiness. Agribusiness will not grow and flourish without the adequate supports from other sectors. To be successful agribusiness, needed the support banking sector, transport / transportation, printing, wholesale and retail and etc. To achieve this, the Government of Aceh need to foster entrepreneurship and a conducive business environment, such as mainstreaming the entrepreneurship in secondary and higher education, streamlining regulations in the field of business and the provision of incentives (e.g. removal / tax relief during the first few years of business establishment) that will create a conducive climate to the growth of service sector.

## Referensi

- Amung Ma'mun dan Yudha M. Saputra (2000). *Perkembangan Gerak dan Belajar Gerak*. Departemen Pendidikan dan Kebudayaan, Jakarta.
- Bank Indonesia; <http://infoukm.wordpress.com>
- BRR NAD-NIAS (2009) *Economy* (Banda Aceh).
- Daryanto, Arief, 2010, *Keunggulan Daya Saing dan Teknik identifikasi Komoditas Unggulan dalam Mengembangkan Potensi Ekonomi Regional*, Institut Pertanian Bogor, Bogor
- Desrochers, P. and Sautet, F. 2004: Cluster-based economic development, facilitation policy and the market process. *Review of Austrian Economics* 17(2/3), 233 – 245.
- Doeringer, P.B., dan Terkla, D.G. 1995, "Business Strategy and Cross-industri Clusters", *Economic Development Quarterly*, Vol.9, No.3, 225\_237, SAGE Publications Cuihong, Yang, 2000, "Study on Multiplier Effect of China Township and Village Enterprises on National Economy, Institute of Systems Science. Chinese Academy of Sciences. Paper submitted to the 13th International Conference on Input-Output Technique, August 21-25, 2000, Macerata, Italy.
- ILO, (1991), *The Dilemma of the Informal Sector. Report of the Director General, Part I*, the 78th Session of the International Labour Conference, Geneva
- ILO EAST project. *Guideline for developing market-driven community-based vocational training for out-of-school youth [Panduan untuk mengembangkan pelatihan kejuruan berbasis masyarakat yang digerakkan oleh pasar untuk kaum muda yang tidak bersekolah]* (Kantor ILO Jakarta).
- ILO (2005) *Training for rural economic empowerment (TREE) Project: Mid-term Evaluation Summary [Pelatihan untuk proyek pemberdayaan ekonomi pedesaan: rangkuman evaluasi jangka menengah]*, tersedia secara online di: [http://www.ilo.org/keterampilan-keterampilan/what/projects/lang--en/WCMS\\_103528/index.htm](http://www.ilo.org/keterampilan-keterampilan/what/projects/lang--en/WCMS_103528/index.htm) [20 April 2010].

- . *Kerangka kebijakan penciptaan lapangan kerja bagi tenaga kerja muda: kasus dan pengalaman Indonesia*.
- IOM (2009) *Labour Market Assessment: Final report [Penilaian Pasar Kerja: Laporan Akhir]* – Bireuen (Aceh).
- IOM (2009) *Labour Market Assessment: Final report [Penilaian Pasar Kerja: Laporan Akhir]* – Lhokseumawe (Aceh).
- Kepel, et. Al (2000) *Penyusunan Rencana Pengembangan Kawasan Andalan Kepulauan Sangihe Talaud*, Badan Pengkajian dan Penerapan Teknologi, Jakarta
- Kuncoro, Mudrajad dan Hairul Aswandi (2002) *Evaluasi Penetapan Kawasan Andalan: Studi Empiris Di Kalimantan Selatan 1993-1999*, Jurnal Ekonomi dan Bisnis Indonesia, Vol 17, Nomor 1, Tahun 2002 : 27-45, BPFE, Yogyakarta
- Nazara, Suahasil (1998) *Analisis Input-Output*, Lembaga Penerbit FEUI, Jakarta
- Pemerintah Provinsi Nanggroe Aceh Darussalam (2007a) *AGENDA: Pembangunan Ekonomi Provinsi Nanggroe Aceh Darussalam*, edisi awal (Aceh).
- (2007b) *ATLAS: Pembangunan Ekonomi Provinsi Nanggroe Aceh Darussalam*, edisi awal (Aceh).
- (2007c) *ATURAN: Pembangunan Ekonomi Provinsi Nanggroe Aceh Darussalam*, edisi awal (Aceh).
- Porter, M.E (1990) *The Competitive Advantage of Nations*, The Free Press, New York
- Rosenfeld, SA. (1995) *Industrial Strength Strategies: Regional Business Clusters and Public Policy*. Washington DC: Aspen institute. hal 36.
- Sarosa, Wicaksono, (2000), "Menyoroti Sektor Informal Perkotaan," Research and Development Director Urban and Regional Development Institute (URDI) diakses pada 7 Agustus 2004 dari <http://www.urdi.org/urdi/bulletin/volume-12a.php>
- Soemarjadi. (2001). *Pendidikan Keterampilan*. Malang: Universitas Negeri Malang.
- USAID Indonesia. (2007), *Jobs for the 21st century: Indonesia assessment [pekerjaan untuk abad ke 21: penilaian terhadap Indonesia]* (Jakarta).
- Yudha & Rudhyanto. (2005). *Pembelajaran Kooperatif untuk Meningkatkan Ketrampilan*. Depdiknas, Jakarta
- World Bank (2009) *Aceh Growth Diagnostic: Identifying the binding constraints to growth in a post-conflict and post-disaster environment [Diagnostik Pertumbuhan Aceh: Mengidentifikasi kendala-kendala yang mengikat terhadap pertumbuhan di lingkungan pasca konflik dan pasca bencana]* (Jakarta).
- World Bank and Bank Indonesia (2009) *Aceh Economic Update [Kondisi Terkini Perekonomian Aceh]*, Mei 2009 (Aceh).

# Building Product Isolating Advantage and Its Affect on Marketing Performance

<sup>1</sup>Ahmad Hanfan, <sup>2</sup>Ahmad Ikhwan Setiawan

<sup>1</sup>Jl. dr. Setia Budi No. 31 Brebes Indonesia, [ahmadhanfan@yahoo.com](mailto:ahmadhanfan@yahoo.com), 08156531394

<sup>2</sup>Jl. Kutilang No. 144, Cindere Kidul, Surakarta Indonesia, [aikhwansse@yahoo.com](mailto:aikhwansse@yahoo.com), 081393939986

## Abstract

The purpose of this study is to explanation of the contradictory results of research on the role of product development capability enhance marketing performance. The research is expected to explanation of the role of product development capability enhance marketing performance that has been deemed unclear by previous researchers by filling an product isolating advantage variable associations between product development capabilities on improving marketing performance. The problem in this research is that there is some contradiction results of research on the relationship influence product development capability on marketing performance as contained in the research gap, so it is still necessary to discover the of the company's product development capability, which in turn have an impact on improving marketing performance. The research issues raised in this research is: "How to develop a model that is built on product development capability that is owned by the company in an effort to improve marketing performance? ". This study tested with (SEM) Structural Equation Modeling and analyzed using AMOS 16.

The results showed that affect product development capability toward product isolating advantage. Customer sensing does not affect product isolating advantage. Product isolating advantage effect marketing performance. Customer sensing affect marketing performance. Product development capability affect marketing performance. Provide an overview of the theoretical implications of reference used, either reference the problem, modeling, and the results of previous research agenda. From the results of a full analysis of SEM obtained theoretical implications, namely when the company has the goal of improving marketing performance, the company needs to consider how to increase product isolating advantage. While the managerial implication is product isolating advantage have an important role in improving marketing performance (0.36), followed by product development capability (0.42) and customer sensing (0.28).

Originality of this study is that the relationship affect product development capability on performance marketing is still being debated researchers. Therefore, this study seeks to explain the relationship between affect of product development capability on marketing performance by adding mediating variables, namely product isolating advantage.

**Keywords** : *Theory of resource-based view (RBV), product development capability, product isolating advantage, customer sensing, marketing performance.*

## 1.Introduction

The company established to achieve certain goals by involving many people. The company requires adequate and sustainable profits in order to survive and provide benefits to both the owner and employees. Therefore the company is required to be able to compete to beat its competitors and maintain the excellence that has been achieved. To achieve these advantages, management is required to produce a good performance. To maximize organization performance in the long term, the company must continue to build and maintain a profitable working relationship with its customers (Slater and Narver, 1995). The creation of superior value for customers is the company's primary capital to be able to gain a competitive advantage.

The purpose of competitive strategy is to achieve a competitive advantage, competitive strategy, enhance the performance of the company and will be in a competitive advantage (Bharadwaj, et al., 1993). According to Porter (1990), sustained ability is when the advantages of the unique assets of the company is able to withstand competitors strategies. Thus, the value of the underlying asset and competitive advantage of a company should be able to isolate from other companies attempt imitate (Barney, 1991). Competitive advantage is the heart of the company's performance in a competitive market. Competitive advantage basically grew from the value or benefit that can be created company for the buyers more than the cost to be incurred by the company to

create it. If the company is then able to create excellence through one of the three generic strategies, it will get the competitive advantage (Aaker, 1989).

The problem in this study come from two sources, namely problems concerning reseach gap and business phenomenon. Reseach gap in this study concerns the controversial views on the affect of product development capability on marketing performance. (Foss 1999) stated that the perspective of capability of the company starts with Edith Penrose in 1959 in his book "The Theory of the Growth of the Firm". Dosi and Teece In Vesalainen and Hakala (2014) states that the capability is defined as a reflection of the company's capability to organize, manage and coordinate the activities. In his research, (Vesalainen and Hakala, 2014) use the term capability of the company as a concept for organizational attributes. Capability of the company is the ability of a product (functional) is coordinated by the business process (eg delivery and new product development process) and integrate other managerial activities (eg, routine management team and information systems).

Dutta, et al., (1999) suggests that company's product development capability that has a proven high maximum impact on financial performance. Then research on pharmaceutical companies, found that the ability of the product development as a source of enduring competitive advantage (Henderson and Cockburn, 1994). Product development capability is affected directly by enviropreneurial marketing and positive influence on the performance of marketing / market share (Baker and Sinkula, 2005). Aydin, et al., (2007) states new product development is not statistically significant at the performance. One possible explanation is that the budget of the research and companies development in Turkey are not enough compared with firms in other countries. Tomita (2009) states that the company's capability to develop products positive effect on competitive advantage. Tomita find that the effective development of new products is one of the most important processes that must be carried out by the company to achieve competitive advantage. Ramaswami, et al., (2009) also stated that the new product development capability is not significant to marketing performance. Tian, et al., (2010) in his research to support a link between company's capability in the widespread use of information technology with a competitive advantage. His research also presents implications for how to develop the ability of the widespread use of information technology and how to get the business value of information technology investments. Banerjee and Soberman (2013) showed that product development capability has a significant impact on the marketing strategy. Company must adopt in order to launch the product in the market where there is significant heterogeneity with regard to consumers' assessment of product performance.

Acikdilli (2013) showed that product development capability, distribution management, delivery management and sales is positively and significantly affect the export market orientation. Also there is a strong relationship between the export market orientation and export performance (ie, financial performance, strategic performance and satisfaction with the export business). Agboh (2014) concluded that the capability of the company in the development and successful launch of the product in the consumer market Nigeria requires candidates competing manufacturers conduct intelligence research in detail about the company's operating environment. It equally requires manufacturers to continuously monitor and analyze the external influences that affect the choice, consumer needs and expectations of consumers, and also obtain and analyze relevant data on strategies, strengths and weaknesses of competitors. It will help the development of products based on the reality of time, thus promoting a sustainable competitive advantage.

To better clarify receach gap in this study, it will be shown in Table 1.1 below :

**Table1.1  
Differences Research Product Development Capability To Performance Marketing**

researc her	Model	Analyze	Finding
Dutta (1999)	Dutta (1999) describe a model in her research that company's capability consists of marketing capability (product development capability) and R & D capability affect the financial marketing which is mediated by the effect of the demand side. Then R & D capability and operations capability affect the financial performance mediated by the effects of the supply side.	Regression	Company's product development capability which has a proven high maximum impact on performance marketing.
Baker and Sinkula (2005)	Baker and Sinkula (2005) describe a model in which enviropreneurial marketing research is influenced by the environment as an opportunity, as a commitment to the	SEM	Product development capability is affected directly by



	environment and the environment as a truth effect on changes in market share through new product success. Then the market volatility (market turbulence) affect enviropreneurial marketing, the success of new products and changes in market share.		enviropreneurial marketing and positive influence on the performance of marketing.
Azizi (2009)	Azizi (2009) describe a model in research marketing capability (the capability to develop products) affect the marketing performance (financial and non-financial). Then marketing strategy affect on marketing performance (financial and non-financial).	Regression	Strategy of product development capability has positive influence on marketing performance.
Aydin (2007)	Aydin (2007) describe a model in which the performance of marketing research influence performance through new product cycle time, the ability of innovation and product design capabilities. Performance marketing direct effect on organization performance.	Regression	New product development capability is not significant to the organization performance.
Ramaswami (2009)	Ramaswami (2009) describe a model in her research that the intensity of research and development affect the company's financial performance through the performance of new product development, the development of customer controls affect the company's financial performance through the performance of new product development, integration between cross divisi affect the company's financial performance through performance development new product. Customer asset orientation affect the company's financial performance through performance management customers, focus on high value customers affect the company's financial performance through performance management customers, customer response to affect the company's financial performance through performance management customers. Sharing information and decisions affect the company's financial performance through the performance of supply chain management, supply chain leadership affect the company's financial performance through supply chain management performance.	SEM	New product development capability is not significant to marketing performance.

Source: Developed for this research.

Research gap existing, the author tries mediate with variable product isolating advantage. Product isolating advantage is a company's superior to isolate the company's products or ease of replication imitate competitors are doing. This research was also conducted on the basis of a business phenomenon that occurs in the production and sales volume in the salted egg Brebes District. One of the areas in Central Java is famous for its salty egg production is Brebes. Department of Industry and Trade Investment Brebes mention that the salted egg is one of the flagship commodity and Brebes. Salted egg producer in the Brebes district is large enough, the range of 150 manufacturers salted egg. With the amount of average production of 2,000 eggs per manufacturer per month. For salted egg producers who have a medium or large scale, salted egg production can reach 10,000 pcs per month (Salted Egg Cluster District Brebes, 2008). Salted egg marketing is done by selling directly to consumers through the showroom / sales areas along the road or at home salted egg producer. For those who do not have a place of business to sell products directly salted egg, ordinary leave the traders in the market or on other manufacturers who have their own place of sale. Manufacturers also accept orders from customers outside of the city by way of salted egg delivery through a travel agency bus or other transportation fleet. Salted egg industry development in production volume and sales volume in Brebes volatile, as shown in Table 1.1 below.

**Table 1.1  
Volume Production and Sales Volume Salted Egg Brebes 2006 to 2012**

Year	Volume Production (grain)	Sales Volume (Rp.000)
2006	2.566.000	2.566.000,00
2007	4.364.680	4.364.680,00
2008	4.618.400	6.003.920,00
2009	4.618.400	6.003.920,00
2010	4.987.872	6.484.233,00
2011	3.672.000	6.426.000,00
2012	3.672.000	6.426.000,00

Source: Brebes District in Figures, 2006 - 2013.

From Table 1.1 above can be seen the development of production volume and sales volume of salted egg in Brebes District has decreased in 2011 that as many as 4,987,872 of production volume dropped to 3.672 million grains of grain and volume of sales of Rp. 6.484233 billion, - down to Rp. 6.426 billion, -. Then in 2011 and 2012 that the volume of production stagnating total sales volume of 3.672 million grains and also stagnating Rp. 6.426 billion, -. For the data from 2002 to 2005 are not available.

The problem in this research is that there is some contradiction results of research on the relationship influence product development capability on marketing performance as contained in the research gap, so it is still necessary to discover company's product development capability, which in turn have an impact on improving marketing performance. Based on what has been described above, the research problems raised in this research is: "How to develop a model that is built on product development capability that is owned by the company in an effort to improve marketing performance?". In connection with the research issues presented above, the purpose of this study is to provide an explanation of the contradictory results of research on the role of product development capability that is able to boost the performance of marketing. Besides, the research is expected to provide an explanation of the role of product development capability that is able to boost the marketing performance that has been deemed unclear by previous researchers by filing an product isolating advantagr variable associations between product development capability on improving marketing performance.

## **2. Literature Review and Hypothesis Development**

### **2.1 Literature Review**

Ferdinand (2003) stated that the capability refers to the company's capacity to deploy resources, usually in combination with the use of the process - organizational processes to achieve the ultimate goal. Capability is a process that is based on the information, can be tangible or intangible that is typical of the company as a result of development in the long term through a complex interaction of these resources (Amit and Schoemaker, 1993). Ferdinand (2003) deliver that capability consists of know-how, raw materials perception, the perception of customer service, the ability to manage change, the ability to innovate, the ability to learn, the ability to group work.

Some management literature indicates that the company's internal capability, have an important effect on the company's innovation, which refers to the organization's openness to new ideas and a willingness to apply them in products and processes (Hurley and Hult, 1998; Wang and Ahmed, 2004). The company created the building capability is not the same for every company, and therefore the results of the development of different abilities for each company. Company tend to develop his capability as directed by the company's strategy. There are few studies that explore the importance of the ability of the company, ie knowledge management capability, technology capability, innovative capability, dynamic capability and core competency (Lin and Hsu, 2007). In addition, the strategy and the ability to have a relationship like "chicken and egg" and should be mutually supportive of one another. When a company's ability valuable, rare, inimitable perfectly, and without equal strategic substitution, it is said to have the ability strategic potential, thus becoming the core capability with the potential to create competitive advantage (Lin and Hsu, 2007).

Eisenhardt and Martin (2000) takes into account that the dynamic capability can not be a source of sustainable competitive advantage, the only way that they can be a source of competitive advantage is if they are implemented faster, smarter, and more by chance than competitors to make resource company configuration. Dynamic capability is a set of regular activities that do everyday that



enables organizations to respond to environmental changes through value creation strategy (Winter, 2003). Study's Baser and Morgan (2008) concluded that consist of five core capabilities : the capability to commit and engage, the capability to balance, capability to adapt, capability to relate and draw support and capability to carry out the task as well - good. Capability is defined as the capacity of the company to use the resources that are integrated with the aim to achieve the desired goal.

Teece, et al., (1997) showed that the Resource Based View Theory (RBV) to complete the theory of industrial organization, in which the theory of industrial organization take out approach and considers the essence of corporate strategy formulation relating to the environment. According to the theory of industrial organization, companies must find their own best favorable position in an industry so that it can defend itself against competitors or even affect the strength of competitors with strategic actions such as blocking the entry or increase entry barriers (Porter, 1985). While RBV argues inside-out approach is what companies can do is not only a function of the opportunities and threats in the industry, but most importantly, the resources that have a sustainable competitive advantage (Teece, et al., 1997).

Company's capability into the realm of theory RBV. The theory of resource-based view (RBV) is more focused on the internal side of the resource company that is owned by the company. Grant (1991) stated the importance of the resources and capabilities of the company. It is a major source of competitive advantage and will increase the difficulty of imitation efforts of competitors. Proponents RBV using internal resources, competencies and capabilities as an important determinant of strategy. This paradigm argues that the difference in performance of the company can be traced back to the assets and capabilities of heterogeneous owned by the company. RBV assumes that every company has a unique resource capability and the growth of the company subject to the efficiency of resource use and deployment capability (Wernefelt, 1984). RBV states that the resources and company's capability determine the competitive advantage and the company enjoys superior capability compared to their competitors, and the company has a significant advantage over competitors. The resources are productive assets owned by the company, while the ability is company's capability to exploit resources efficiently, to produce a product or developing services to achieve business goals (Peteraf, 1993; Russo and Fouts, 1997; Raphael and Schoemaker, 1993).

Azizi, et al., (2009) states that a theory based on demonstrated company's capability is a combination of resources and capability, and they should continue to invest in unique ways to maintain and expand their marketing capability. Company with high marketing capability will be a pioneer in identifying customer needs and recognizes the factors that influence their purchasing behavior will be able to place their products in the best position compared to its competitors. Azizi, et al., (2009) also found company's product development capability has positive influence on marketing performance. Hsu, et al., (2008) found product development capability and marketing distribution channels is the main priority of resource relationships in which the manufacturing company in Taiwan seeks to build product development capability and the marketing distribution channels.

Study's Li and Huang (2012) found that hand skills that reflect the interaction between exploitation and exploration play the role of mediating a positive relationship between product development capability and performance. Some studies emphasize the importance of hand skills as one of the dimensions of the product development capability to handle the challenges of innovation and improve performance (Cao, et al., 2009; Lubatkin, et al., 2006). Ulrich (1991) stated that in order to build a product or service is better, the price of goods or services that are lower in the competition, or incorporate technological innovations in research and manufacturing operations must be equipped with the company's capability to manage people to gain competitive advantage. To build organizations capacity, businesses must be able to adapt to changing customer and strategic needs by establishing internal structures and processes that affect their members to create organization-specific competencies. There is recognition that market-based capability to contribute to the company's financial performance (Srivastava, et al., 1998). Srivastava, et al., (1999) provide a conceptual framework based on the resource-based view of the firm that connects the ability of the company based on the market with the company's performance using the concept of mediation process performance. According to Srivastava, et al., (1999); Zahay and Handfield (2004), based on the company's capability to create value for the enterprise market in three important categories of the organization, namely: the process of new product development, customer management processes and supply chain management processes. Five dimensions of product development capability by (Ulrich and Eppinger 2004) is the product quality, product cost, product development time, cost of product development and product development capability. While the definition of the product development capability is company's capability to conduct a series of activities starting from the perception of market opportunities and ends with the production, sale and delivery of products. Corporate ownership over scarce resources and are difficult to imitate is not enough to ensure the

company continues to have a competitive advantage. Isolation mechanism to prevent other companies taking part or all of the company's profits. Isolation mechanism useful to protect products or services by preventing impersonation superior product. In addition to significantly inhibit replication, there are other techniques that can be used that are not real. No real barriers can be created indirectly, when the company has created a unique capability. Rumelt (1991) divides the barriers - barriers in the form of causal ambiguity, dependence on historical circumstances and social complexity. Causal ambiguity is a situation where a company with capabilities that are not easily defined and can only imperfectly understood, but still be able to create value for stakeholders. Knowledge and skills (knowledge and knowhow) owned a tacit knowledge, which is the capability that has become one with the owner, but it is difficult to be articulated in the form of formulas, algorithms or rules. Such knowledge is usually obtained from trials and refined through practice and experience, rarely written data or codified in manuals, and can only be proven if practiced directly.

The Company may also not be able to replicate the ability of competitors because of the history and experience. Dependence on the past (Dependence on Historical Circumstances) limit the ability to grow and develop from the new operational needs. Dependence on Historical Circumstances can only be used for short periods. Good relationships of company managers to suppliers and consumers, including the difficult simulated. The company's dependence of causal ambiguity, dependence on the historical and social circumstances complexity cause the company to maintain a competitive advantage. Reed and DeFillippi (1990) proposes three types of management skills to achieve causal ambiguity that tacitness, complexity and specificity. Tacitness, complexity and specificity lead to sustainable competitive advantage.

Product isolating advantage is company superiority to isolate company's products or ease of replication imitate competitors are doing. Product isolating advantage is part of the resource-based theory of view (RBV). The theory of resource-based view (RBV) assumes that each company has a unique resource capability and growth of the company subject to the efficiency of resource use and deployment capability (Wernerfelt, 1984). RBV states that the resources and company's capability determine the competitive advantage and the company enjoys superior capabilities compared to their competitors, and the company has a significant advantage over competitors. The resources are productive assets owned by the company, while the capability is the capability of companies to exploit resources efficiently, to produce a product or developing services to achieve business goals (Peteraf 1993; Russo and Fouts, 1997; Raphael and Schoemaker, 1993).

The theory of resource-based view (RBV) are relatively new in the field of strategic as well as in the field of marketing. Resource-based view (RBV) was first introduced by Wernerfelt in 1984, the concept of resource-based view (RBV) assume that the company's capability to compete is dependent upon the uniqueness of existing resources within the organization (Wernerfelt, 1984). The concept of resource-based view (RBV) assume the view that the company is a collection of resources (Wernerfelt, 1984). Besides, the concept of resource-based view (RBV) also considers that the competitive ability of the organization is a function of the uniqueness and value of resources and capabilities possessed by the organization, besides that this concept also considers that the capability is the main source to achieve a sustainable competitive advantage. The difference in resources and capabilities with a competitor company is a source of competitive advantage (Peteraf, 1993). Then Teece and Shuen (1997); Teece, et al., (1997) said in his research that the resource-based view (RBV) is the approach used by the company in achieving a sustainable competitive advantage based resources. According to the resource-based perspective, the determinant of the company's performance is the capability and assets - assets of specific companies, as well as the mechanism - a protection mechanism position. These include intangible assets, such as skills in the field of technology and managerial (Teece, et al., 1997). Resource-based view (RBV) developed into a highly influential theory in the field of good management in the field of strategic management (Cohen and Levinthal, 1990) and in the field of strategic marketing management (Day, 1994). One strength of resource-based theory view (RBV) is the ability to explain why a company has a competitive advantage with its competitors. Competency-based perspective in strategic management that is rooted in the resource-based view (RBV) shows the integration of approaches - approaches that exist, so as to provide greater clarity on systemic and holistic sustainable competitive advantage. The theory of resource-based view (RBV) is closely linked with the concept of product differentiation in creating competitive advantage.

According to Porter (1985) there are three ways to reach to achieve competitive advantage is cost advantage, differentiation and focus, which in turn will improve marketing performance. Differentiation is the act of designing a set of meaningful difference for contrasted firm offers from competitors' offerings (Kotler, 2002). Kotler (2002) differentiation strategy divides into five types of differentiation, namely: product (features, suitability, durability, reliability, easy to fix, style, design),

services (ease of ordering, delivery, installation, customer training, customer consulting, maintenance and repair, hospitality), personal (ability, trustworthy, reliable, fast, responsive, communicative), channel (range, expertise, performance), imagery (symbol, written and audiovisual media, the atmosphere, the event).

(Porter (1990) states that there are three types of generic strategies, the strategy of cost leadership, differentiation strategy and focus strategy. Differentiation strategy is a strategy of how companies are trying to be different and unique compared to its competitors. Product differentiation can be regarded as a new product. In a study Song and Parry (1997) found a significant positive relationship between the level of success of new products by measurement of product differentiation. The entry of new products into the market will shift the customer's choice of the old product to the new product. Ferdinand (2000) states that the development of marketing strategies through a variety of approaches that focus on the development of differentiation or the creation of various points of differentiation do not manyamai value generated for a competitor for its customers, but to provide more value or superior value. Nowlis and Simonson (1996) found no effect of the new product on the impact of voting behavior. The entry of a new product that has certain characteristics (brand new entry) turns out to have a particular impact. Customers also liked the alternative products that clearly have better attributes and not extreme. According to Pelham (1997), by stressing factors - factors that affect the success rate of new product market opportunities should be used by companies as possible so as to improve marketing performance. It is expected to improve the performance of marketing in the company such as the effectiveness of the company, the growth of assets / portion and profit growth.

## **2.2 Hypotheses Development**

### **a. Product Development Capability with Product Isolating Advantage**

Ulrich (1991) stated that in order to build a product or service is better, the price of goods or services that are lower in the competition, or incorporate technological innovations in research and manufacturing operations must be equipped with the company's ability to manage people to gain competitive advantage. To build the capacity of organizations, businesses must be able to adapt to changing customer and strategic needs by establishing internal structures and processes that affect their members to create organization-specific competencies. Five dimensions of product development capability by (Ulrich and Eppinger, 2004) is the capability to improve product quality, product development capability cost efficiency, time efficiency of product development capability and product development capability. While the definition of the product development capability is the capability of the company to conduct a series of activities starting from the perception of market opportunities and ends with the production, sale and delivery of products. Dimensions of product development capability that is used in this research is the ability to create original products, the capability to modify the products and capabilities enhance the content of the product formula (Ulrich, 1991; Sethi, 2000; Ulrich and Eppinger, 2004; Kotler and Armstrong, 2012).

The existence of the product development team is generally not found in the SME, this is caused by a factor of limited resources and knowledge of SMEs on the product development process and the importance of the quality of the new product. The process of product development lies with the business owner or manager of SMEs (Kusmantini, et al., 2011). Sethi (2000) in his research organization mengidentifikasi four contextual factors that influence the quality of new products that consumer involvement, quality orientation, level of novelty products (product innovativeness) and the pressure time (time pressure). Zahra and Das (1993) describes several types of product innovation is the ability to modify existing products, the ability to develop product lines and menciptakan product that is completely new for the company.

Meanwhile, Kotler and Armstrong (2012) defines the product development as the original product development for the company and the market, improved product / enhance long products, product modifications and new brands through the company's product development efforts of the company. Then research on pharmaceutical companies, found that the ability of the product development as a source of enduring competitive advantage (Henderson and Cockburn 1994). (Baker and Sinkula 1999) states that a process of new product development (NPD) which either must produce a product that is unique and different, enjoy the success of the market and can develop time efficiency. Portfolio organizational capabilities with a high degree of social complexity affect the level of company differentiation advantage (Ferdinand, 2003).

Tomita (2009) states that the company's capability to develop products positive effect on competitive advantage. Tian, et al., (2010) in his research to support a link between the ability of companies in the widespread use of information technology with a competitive advantage. Atkin, et al., (2012) clearly shows a significant difference businesses that use environmental management

system (EMS) as compared to businesses that do not use EMS in cost leadership and differentiation advantages. Businesses that use EMS, it can significantly larger optimize the supply chain and can streamline operational costs than those who do not use EMS. Those who use the EMS can also improve the ability to enter new markets in a much greater rate than that not using EMS.

Furthermore Sun (2010) explains that many companies are trying to develop a new product design by adding "attribute trivial" to differentiate them and attract the attention of consumers as well as to influence their purchasing decisions, such as Procter & Gamble distinguish Folger, an instant coffee, with "coffee crystals are flattened ". Broniarczyk and Gershoff (2003) states that a manager's ability to make use of trivial attribute strategy to create competitive advantage depends on the brand equity and decision context. Agboh (2014) concluded that company's capability in the development and successful launch of the product in the consumer market Nigeria requires candidates competing manufacturers conduct intelligence research in detail about the company's operating environment. It equally requires manufacturers to continuously monitor and analyze the external influences that affect the choice, consumer needs and expectations of consumers and also obtain and analyze relevant data on strategies, strengths and weaknesses of competitors. It will help the development of products based on the reality of time, thus promoting a sustainable competitive advantage.

Thus, the proposed hypothesis is as follows :

Hypothesis 1: Product development capability influence on product isolating advantage.

### **b. Customer Sensing with Product Isolating Advantage**

According to Narver and Slater (1990b), market orientation consists of three elements, namely the behavior of customer orientation, competitor orientation and coordination among functions. In this perspective the market orientation is defined as an organizational culture that is very efficient and effective way to create superior value for buyers, so that will generate superior business performance continuously - constantly. Slater and Narver (1995) found a market oriented organizational culture that puts top priority on creating profits and build superior customer value by taking into account the desire of stakeholders and establish norms - norms associated with behaviors that support the organization and responsiveness to market information. Based on these opinions, market orientation is a concept that is integrated with three components : customer orientation, competitor orientation and coordination among functions. Sensing the customer is a process that generates sensing activities that refer to the information on consumers, competitors and taste in pengambilan decision, referring to the interpretation of the information collected on past experience and knowledge, whereas the response refers to the use of information collected and interpreted in decision making. Dimensions customer sensing used in this research is the search for information from the customer, the customer market environment vision and understanding of the changing tastes of customers (Day, 2002) and (Suherna, 2014).

The key point in the market orientation according to the behavioral approach (Jaworski and Kohli, 1993) lies in the widespread focus on the market of the limited knowledge on consumers, coordination between functions in acquiring knowledge of the market, is more focused on the activities related to the management of information as compared to the effect of activity the. Kohli and Jaworski (1990) considered that the conceptualization of market orientation concentrates on how a company applying specific behavior to market information processing in an organization. Day (1994) suggests that market orientation is a superior ability to understand and satisfy consumers. The key point in this approach include organizational culture guided by the wishes of consumers, the organization's capability to understand the information consumers, competitors and distribution, implementation of coordination between functions to build superior customer value. Olivares and Lado (2003) define market orientation as a competitive strategy that is able to explain the widely behavior can increase the value to the consumer and to guarantee the long-term performance. Furthermore Olivares and Lado (2003), revealed nine-forming aspects of market orientation, which is an analysis of the final consumer, analysis of consumer mediation (distributor), analysis of competitors, analysis of the market environment, a strategy of action against the consumer end, a strategy of action against the consumer mediation, action strategies against competitors, action strategies to the market environment and coordination among functions.

Meanwhile Li and Calantone (1998) suggested that one of the variables of market knowledge competence is management / customer knowledge management. (Li and Calantone 1998) states that the customer knowledge management consists of three dimensions, namely gain knowledge about customers, translating knowledge about customers and combine knowledge of customer knowledge pelanggan. Pengelolaan a sufficient understanding of the target buyers to be able to create superior value for they are kept - constantly and create a more superior performance for the organization (Narver and Slater, 1990). While the leading organization committed to the importance of customer

orientation is management's efforts to create customer value in practice to build awareness of the workers to understand the needs and desires of customers. In this case more quickly in response to complaints that the sooner the consumer needs to change as well as create and maintain a satisfied and loyal customers will be very good (Ferdinand, 2000). Then Brady and Cronin (2001) suggested that customers provide an understanding of knowledge management more organizations to determine the needs and wants of customers. Meanwhile, according to Ferdinand (2000), the best way to produce organization performance in a competitive market is to focus instead on its competitors, but the customers. This means that economic rationality will require management of the organization prefers to focus efforts to bind potential customers by developing customer-oriented strategy. While Foley and Fahy (2004), states that the sensing ability of the market as a way to facilitate the understanding of the creation of a market orientation.

According to Weick, et al., (2005), sensing is the mechanism a set of organizations to continue to acquire, communicate and act on trends and events in an enterprise environment. When the company is equipped with market sensing capability, usually involving the exchange of strategic information competency, strategic complexity and some consideration perspective (Neill, et al., 2007). As for the new product development team members, they through this competency can efficiently integrate different perspectives on market information that can lead them to be more effective in configuring and deploying resources, so get the effect of the resources to serve superior customer value. Folinas and Rabi (2012) in his study on sensing a request stating that the implementation of demand sensing is a key solution that became the backbone of controlling demand, and in doing so significant benefits for many companies CPG (consumer packaged goods), because it will give them a competitive advantage .

Thus, the proposed hypothesis is as follows :

Hypothesis 2: Customer sensing influence on product isolating advantage.

### **c. Product Isolating Advantage with Marketing Performance.**

Product isolating advantage is part of the resource-based theory of view (RBV). The theory of resource-based view (RBV) assumes that each company has a unique resource capability and the growth of the company subject to the efficiency of resource use and deployment capability (Wernefelt, 1984). RBV states that the resources and capabilities of the company determine the competitive advantage and the company enjoys superior capabilities compared to their competitors, and the company has a significant advantage over competitors. The resources are productive assets owned by the company, while the ability is the ability of companies to exploit resources efficiently, to produce a product or developing services to achieve business goals (Peteraf, 1993; Russo and Fouts, 1997; Raphael and Schoemaker, 1993). Corporate ownership over scarce resources and are difficult to imitate is not enough to ensure the company continues to have a competitive advantage. Isolation mechanism to prevent other companies taking part or all of the company's profits. Isolation mechanism useful to protect products or services by preventing impersonation superior product. In addition to significantly inhibit replication, there are other techniques that can be used that are not real. No real barriers can be created indirectly, when the company has created a unique capability. Rumelt (1991) divides these barriers in the form of causal ambiguity, dependence on historical circumstances and social complexity.

Ferdinand and Batu (2013) stated that the program of new product development is the high cost of the program, but the level of success in entering the market is still low. To answer these questions, they propose a concept called architecture isolate marketing capabilities (MAIS-Cap). The company must have some sort of ability in designing the architecture of the platform marketing strategy by isolating or ease of replication to replicate. Architecture isolate marketing capabilities (MAIS-Cap) is a special competence to spread the marketing strategy in a particular way in a manner isolated from the ease of replication, therefore, difficult to imitate and have the potential for success. Bharadwaj, et al., (1993) states that the dimension of competitive advantage is the distinctiveness of products, competitive prices, rare, difficult to imitate and hard to replace. Porter (1985) states that one of the dimensions of competitive advantage is customer focus. Aaker (1989) states that the successful differentiation strategy should be a strategy that is able to generate customer value, led to the perception that a typical and well worth and appear as a different form that is difficult to replicate. Grant (1991) states that the resources are categorized into tangible, intangible and human resources. Real resources are capital resources, equipment, factory and other, whereas intangible resources is the company's reputation, brand image and perceived quality of its products. Intellectual capital or human resources are the skills and knowledge of employees, and knowledge-oriented assets. Product isolating advantage is company's superiority to isolate of the company's products or ease of replication imitate competitors are doing. Dimensions of product isolating advantage in this study is

the extent to product, difficult to imitate and difficult to replace (Rumelt, 1991; Jaworski and Kohli, 1991; Bharadwaj, et al., 1993; Song and Parry, 1997).

Study Song and Parry (1997), found a positive relationship between the level of success of a product with a competitive advantage. Song and Parry (1997) stated that the indicators of competitive advantage, namely product uniqueness, quality products and competitive prices. Jaworski and Kohli (1991) states that the dimension of competitive advantage is innovation, price and time. While Li and Calantone (1998), stated that the indicator of the competitive advantage of the new product consists of quality, resilient, product novelty and uniqueness of the product. The results of the study Li (2000), found a positive effect of competitive advantage with marketing performance as measured by sales volume, the rate of profit, market share and return on investment. Langerak, et al., (2004) states that the product excellence and proficiency in tactics positively related to the launch of new product performance, and it is positively related to organizational performance. Likewise, Newbert (2008) found that competitive advantage is positively related to performance. Mazaira, et al., (2003) in his study found that market-oriented culture, built on a clear definition of target customers and market the concept of the original, will produce a sustainable competitive advantage. Martinette and Leeson (2012) states that the competitive advantage moderate the relationship between learning orientation and business performance in the field of pure services and service organizations. Seogoto (2010) prove that the source of competitive advantage, marketing strategy and positional advantages significant effect on marketing performance. Peters (2007) found that the company's competitive advantage will be even greater if the company's financial performance compared to the average financial performance of the industry is also getting bigger, meaning that the higher the performance, the higher the company's competitive advantage. Martinette and Leeson (2012) in a study stating that the competitive advantage moderate the relationship between learning orientation and performance in the field of pure services and service organizations.

Thus, the proposed hypothesis is as follows :

Hypothesis 3: Product isolating advantage influence on marketing performance.

#### **d. Customer Sensing with Marketing Performance**

Day (2002) and Suherna (2014) states that the market can be divided into two subprocesses, namely sensing and response. Sensing is information to customers, competitors and other groups then the decision is to interpret the information together based on experience and knowledge. The response is an opportunity together and received information and objectives, with the response will be contained suitability of the information and knowledge in accordance with the treatment market. Thomas, et al., (1993) that examines the customer sensing, stated that the ability to scan, interpret, and respond from top managers can be linked to performance. The ability to scan involves environmental companies to identify information that is associated with the organization. Interpret is to understand the information and decide which strategic issues to address organizational issues, responding is responding to the changes that occur in practice that occurs in the organization. Thomas, et al., (1993) defines sensing as reciprocal interaction search information, assumptions and actions.

A perspective capability will facilitate a more meaningful understanding of the development of market orientation. To identify key capabilities, the need to disassemble or describe, following the precedent of decomposition ability to connect customers (Day and Bulte, 2002). Day and Bulte (2002) parse the ability to connect customers into three dimensions, namely information, configuration and orientation. Sinkula, et al., (1997) proposed a market-sensing capability consists of four dimensions, which have particular resonance in the organization's activities, namely the market sensing systems, marketing information, communication and learning orientation. Soliman (2011) explores the theoretical foundations of customer relationship management and its relationship with the marketing performance of the various perspectives found a positive and significant relationship between the customer knowledge management and marketing performance. Reichheld in Thakur (2005), states that the company costs six times more to acquire a new customer than to retain an existing customer. Therefore, many companies pay more attention to maintain and develop relationships with customers, which is likely to increase the willingness of customers to engage in a relationship with the company. The findings of the study Thakur (2005), showed that the willingness of customers to engage in a relationship with the company depends on a firm stance depending on the customer and customer knowledge and beliefs about customer relationship management program of the company.

Namjoyan, et al., (2013) states that affect customer relationship management marketing performance. Research results also showed that the technology-based customer relationship management, knowledge management, customer relationship management organization has a significant positive effect on marketing performance. Furthermore, market orientation culture

contribute to the level of market knowledge competence (Kandemir, 2005). Then the market knowledge competence affect the performance of the company in several ways : First, market knowledge competence improve customer performance. Second, improve the speed of marketing strategy formulation and implementation. Third, market knowledge competence improve learning marketing performance .

Hou and Chien (2010) which explores the impact of market knowledge competence to performance management through dynamic capability perspective on 192 Taiwanese company found an association between dynamic capability, competencies, knowledge management market and business performance. Dynamic capability have a positive impact on market knowledge management competency. Competence and knowledge management market dynamic capability positive effect on business performance and the mediating effect of market knowledge management competence on the relationship between dynamic capability and financial performance. Performance marketing is a concept to measure the impact of the strategy applied by the company as a reflection of the existing market activities include an increase in sales volume, market share and profits. Ferdinand (2000) states that the company's strategy has always aimed to produce marketing performance (sales volume), market share and sales growth rates and financial performance. According to Voss and Voss (2000), is defined as a business marketing performance measurement performance levels include sales turnover, the number of buyers, profits and sales growth. Dimensional marketing performance used in this study is sales growth, sales volume and sales gains.

Thus, the proposed hypothesis is as follows :

Hypothesis 4: Customer sensing influence on marketing performance.

#### **e. Product Development Capability with Marketing Performance**

Ulrich (1991) stated that in order to build a product or service is better, the price of goods or services that are lower in the competition, or incorporate technological innovations in research and manufacturing operations must be equipped with the company's ability to manage people to gain competitive advantage. To build the capacity of organizations, businesses must be able to adapt to changing customer and strategic needs by establishing internal structures and processes that affect their members to create organization-specific competencies. There is recognition that market-based capabilities to contribute to the company's financial performance (Srivastava, et al., 1998). Srivastava, et al., (1999) provide a conceptual framework based on the resource-based view of the firm that connects the ability of the company based on the market with the company's performance using the concept of mediation process performance. According to Srivastava, et al., (1999); Zahay and Handfield (2004) stated that based on the company's capability to create value for the enterprise market in three important categories of the organization that is the process of new product development, customer management processes and supply chain management processes.

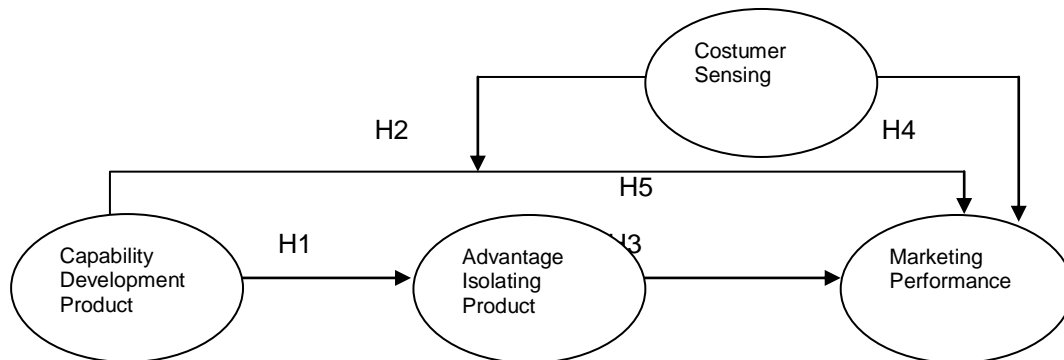
Dutta, et al., (1999) suggests that company's product development capability that has a proven high maximum impact on the financial marketing. Then the ability of the product development is influenced directly by enviropreneurial marketing and positive influence on marketing performance / market share (Baker and Sinkula, 2005). Aydin, et al., (2007) states that the development of new products are not statistically significant at the performance. One possible explanation is that the budget of the research and development companies in Turkey are not enough compared with companies in the country - other countries. Likewise Tooksoon and Mohamad (2010), which examined the relationship between marketing capability and export performance and the moderating effects of dependence on exports. Thai Agro's marketing capability -based export company can be classified into four dimensions, namely the product development capability, distribution capability, price capability and promotion capability. Among the four dimensions of marketing capability, only price capability and promotion capability significantly and positively related to performance marketing / export (dimensions: profit margins, sales growth), while product development capability and distribution capability are not positively related to performance. Banerjee and Soberman (2013) showed that product development capability has a significant impact on the marketing strategy. The company must adopting to launch the product in the market where there is significant heterogeneity with regard to consumers' assessment of the performance of the product. Acikdilli (2013) showed that product development capability, channel management, delivery management and sales is positively and significantly affect the export market orientation. Also there is a strong relationship between the export market orientation and export performance (ie, financial performance, strategic performance and satisfaction with the export business).

Thus, the proposed hypothesis is as follows:

Hypothesis 5: product development capability influence on marketing performance.

To refine the above, then further research study conducted to deliver the following empirical research model (Figure 1).

**Gambar 1  
Empirical Model**



Source: Developed for this research.

### 3. Research Methods

#### 3.1 Types and Sources of Data

This study uses primary data, ie data obtained by questionnaire-based interviews to a number of respondents were selected for this study. The research design used in this research is descriptive research design. Data collected by survey method through a structured questionnaire with a ten-point grading scale. Questionnaires were processed and analyzed using Structural Equation Modeling using AMOS 16.

#### 3.2 Population and Sample

This study was conducted with a population of 352 companies MSMEs (Micro, Small and Medium Enterprises) in a typical food industry that is transparent salt industry in Bradford district, Central Java Province. The samples used as much as 115 respondents, this number meets the minimum criteria of the standard samples suggested by Hair et al., (2010), which states that the number of samples is 5 times the number of indicators. This study indicator number 12, the number of samples used in this study was  $5 \times 12 = 60$  samples. Then the recommended sample size from 100 to 200 companies. By using a sample of 115 respondents, sample size requirements can be met.

#### 3.3 Sources of Data

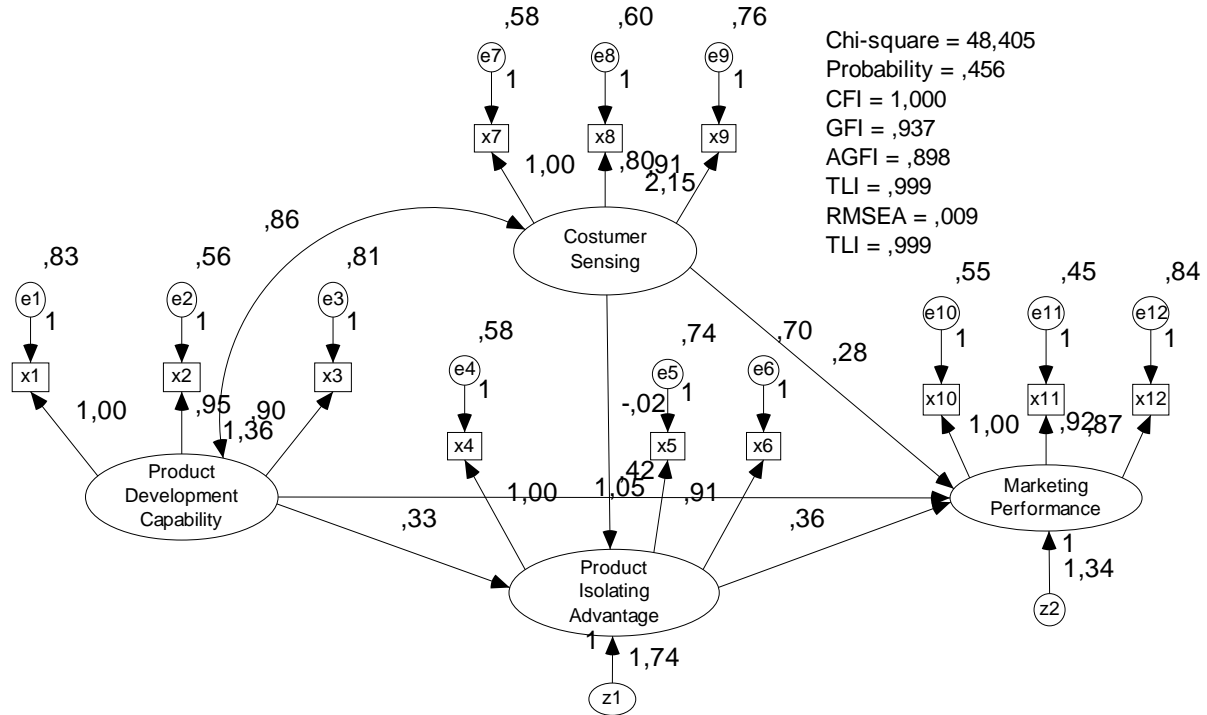
The sampling technique is based on a sample random sampling because sampling is done at random members of the population regardless of the strata in the population. Sampling is done in a way that will ensure that the selection of the element - the element to be investigated based on objectivity, not subjectivity. This study uses primary data obtained from the questionnaires were distributed directly to 115 manager / owner of MSMEs (Micro, Small and Medium Enterprises) food and beverages in the district of Bradford. Data collected through the survey, which is conducted by asking respondents. Research methods in the survey was conducted using research instruments such as questionnaires with open questions consist of items that represent the independent variables and the dependent variable. Questionnaires were distributed to respondents directly, so that respondents can provide value and short answer open questions available. This questionnaire was developed by assigning weights to the value of the answer (1) Strongly Disagree to (10) Strongly Agree. This section describes the basic measurements of the most important variables for this study.



#### 4. Results and Discussion

##### 4.1 Hypothesis Testing

From the hypothesis, then the hypothesis is tested using AMOS 16.



##### Goodness of Fit

Goodness of Fit Index	Cut-Off Value	Analysis Result	Model Evaluation
Chi-Square	expected small	48,405	Good
Probability	≥0.05	0,456	Good
RMSEA	≤0.08	0,009	Good
GFI	≥0.90	0,937	Good
AGFI	≥0.90	0,898	Marginal
TLI	≥0.95	0,999	Good
CFI	≥0.95	1,000	Good

Source: Primary data were processed, 2015.

##### Regression Weights: (Group number 1 - Default model)

		Estimate	S.E.	C.R.	P	Label
Product_Isolating_Advantage	<-- Product_Development_Capability	,326	,152	2,146	,032	
Product_Isolating_Advantage	<-- Customer_Sensing	-,024	,115	-,211	,833	
Marketing_Performance	<-- Product_Isolating_Advantage	,364	,101	3,613	***	
Marketing_Performance	<-- Customer_Sensing	,278	,107	2,609	,009	
Marketing_Performance	<-- Product_Development_Capability	,422	,146	2,895	,004	
x1	<-- Product_Development_Capability	1,000				
x2	<-- Product_Development_Capability	,948	,113	8,394	***	

		Estimate	S.E.	C.R.	P	Label
x3	- bility <-- Product_Development_Capability -	,896	,114	7,887	***	
x7	<-- Costumer_Sensing -	1,000				
x8	<-- Costumer_Sensing -	,801	,073	10,921	***	
x9	<-- Costumer_Sensing -	,913	,083	10,964	***	
x4	<-- Product_Isolating_Advantage -	1,000				
x5	<-- Product_Isolating_Advantage -	1,047	,096	10,953	***	
x6	<-- Product_Isolating_Advantage -	,909	,086	10,571	***	
x10	<-- Marketing_Performance -	1,000				
x11	<-- Marketing_Performance -	,925	,068	13,655	***	
x12	<-- Marketing_Performance -	,873	,074	11,767	***	

From the results of data processing using AMOS analysis tools 16 sbagai following results are obtained: the goodness of fit as a chi-square value with Chi-Square = 48.405, probability = 0.456 indicates that the model fits the empirical data. It is also supported by other fit criteria such as GFI = 0.937; TLI = 0.999; CFI = 1.000; RMSEA = 0.009 which all meet the criteria of fit as recommended (Ghozali, 2011). Hypothesis testing showed significant results with the value of CR = 2.146 > 1.96 with probability = 0.032, the probability of testing to qualify under 0.05. Thus H1 accepted in this study. Estimation of the parameters of the relationship between the two variables was obtained for 0.362. Tests showed no significant results with the value of CR = -0.211 > 1.96 with probability = 0.833, the probability of testing does not qualify under 0.05. Thus H2 in this study can not be accepted. Estimation of the parameters of the relationship between the two variables was obtained for -0,024. Tests showed significant results with the value of CR = 3.613 > 1.96 with probability = 0.000, the probability of testing to qualify under 0.05. Thus H3 in this study may be accepted. Estimation of the parameters of the relationship between the two variables was obtained for 0.364. Tests showed significant results with the value of CR = 2.609 > 1.96 with probability = 0.009 probability of testing to qualify under 0.05. Estimation of the parameters of the relationship between the two variables was obtained for 0.278. So H4 in this study may be accepted. Tests showed significant results with the value of CR = 2.895 > 1.96 with probability = 0.004 probability of testing to qualify under 0.05. Estimation of the parameters of the relationship between the two variables was obtained for 0.422. So H5 in this study may be accepted. So the hypothesis 1,3,4,5 is accepted, while the second hypothesis is not accepted.

#### 4.2 Theoretical Implications

Provide an overview of the theoretical implications of the references used in this study, both the referral problem, modeling, results and previous research agenda. The theoretical implication is a reflection for each study. From the results of a full analysis of SEM obtained theoretical implications, namely when the company has the goal of improving marketing performance, the company needs to consider how to increase product isolating advantage.

#### 4.3 Managerial Implications

Based on the research results, product isolating advantage in a positive and significant effect on marketing performance. In order to improve marketing performance, product isolating advantage is influenced positively by product development capability. The test results show that the advantages of full SEM insulation products have an important role in improving the marketing performance(0.36),

followed by product development capability (0.42) and customer sensing (0.28).

## **5. Conclusion, Research Limitations and Future Research**

### **5.1. Conclusion**

From the above data analysis, hypothesis testing 1 shows the significant results with the value of  $CR = 2.146 > 1.96$  with probability = 0.032, the probability of testing to qualify under 0.05. Thus H1 accepted in this study, effect product development capability on product isolating advantage. Testing Hypothesis 2 shows the results were not significant with a value of  $CR = -0.211 > 1.96$  with probability = 0.833, the probability of testing does not qualify under 0.05. Thus H2 in this study can not be accepted, that is customer sensing does not affect on product isolating advantage. Non-acceptance of the hypothesis 2, probably due to the variable should be replaced with a variable containing the company's capability, because associated with product excellence, for example, variable product imaging capability. 3 hypothesis testing showed significant results with the value of  $CR = 3.613 > 1.96$  with probability = 0.000, the probability of testing to qualify under 0.05. Thus H3 in this research is acceptable, ie customer sensing affect on marketing performance. Testing Hypothesis 4 shows the significant results with the value of  $CR = 2.609 > 1.96$  with probability = 0,009 probability of testing to qualify under 0.05. So H4 acceptable in this study, namely customer sensing affect on marketing performance. Testing the hypothesis 5 showed significant results with the value of  $CR = 2.895 > 1.96$  with probability = 0.004, the probability of testing to qualify under 0.05. So Hypothesis 5 in this study may be accepted, which affect product development capability on marketing performance.

### **5.2 Limitations of Research**

The author is aware of the limitations in this study. This limitation involves several things such as the model and the number of survey respondents. Conceptual limitations in this study lies in the test model is simple. Non-acceptance of the hypothesis 2, probably due to the variable should be replaced with a variable containing company's capability, because associated with product excellence, for example, variable product imaging capability. This is explained Wang and Ahmed (2004) which states that we improve understanding of the competitive value of market orientation on dynamic capability perspective. A perspective capability will facilitate a more meaningful understanding of the development of market orientation. To identify key capability, the need to disassemble or describe, following the precedent of decomposition ability to connect customers (Day and Bulte, 2002). Understanding of the nature of marketing knowledge, Olavarrieta and Friedmann (1996) states that the market orientation affects the market sensing capability, innovation capability and capability to imitate. Menguc and Auh (2006) in a study to develop a conceptual model that explains how market orientation can be converted into a dynamic capability when equipped with variable transformational / reconfiguration as innovation. The next limitation is the number of respondents who are still limited so as not to be able to dig deep to each variable studied. There are limitations to this study, expected in the next research in order to develop further the use of the model and the number of respondents in order to better study the resulting research more efficient.

### **5.3 Future Research**

Limitations of the model in this study is not equipped with a variable that can be creative product. With the limitations of the research model, the authors suggest in future research to add a variable that can introduce products such as variable product imaging capability.

## References

- Aaker, D. A. 1989. Managing Assets And Skills: The Key To A Sustainable Competitive Advantage. *California Management Review* 31 (2):91.
- Acikdilli, G. 2013. The Effect of Marketing Capabilities and Export Market Orientation on Export Performance. *INTERDISCIPLINARY JOURNAL OF CONTEMPORARY RESEARCH IN BUSINESS* 5 (6):30-59.
- Agboh, I. C. 2014. COMPETITIVE INTELLIGENCE FRAMEWORK FOR PRODUCT DEVELOPMENT: AN ANTIDOTE TO MANUFACTURERS' PENETRATION OF NIGERIAN CONSUMER MARKET. *Global Conference on Business and Finance Proceedings* 9 (2):28-36.
- Amit, R., and P. J. H. Schoemaker. 1993. STRATEGIC ASSETS AND ORGANIZATIONAL RENT. *Strategic Management Journal* 14:33-46.
- Atkin, T., A. G. Jr., and S. K. Newton. 2012. Environmental strategy: does it lead to competitive advantage in the US wine industry? *International Journal of Wine Business Research* 24 (2):115-133.
- Aydin, S., A. T. Cetin, and G. Ozer. 2007. THE RELATIONSHIP BETWEEN MARKETING AND PRODUCT DEVELOPMENT PROCESS AND THEIR EFFECTS ON FIRM PERFORMANCE. *Academy of Marketing Studies Journal* 11 (1):53-68.
- Azizi, S., S. A. Movahed, and M. H. Khah. 2009. The effect of marketing strategy and marketing capability on business performance. Case study: Iran's medical equipment sector. *Journal of Medical Marketing* 9: 309 – 317.
- Baker, W. E., and J. M. Sinkula. 1999. The synergistic effect of market orientation and learning orientation on organizational performance. *Journal of Academy of Marketing Science* 27 (4):411-427.
- . 2005. Environmental Marketing Strategy and Firm Performance: Effects on New Product Performance and Market Share. *Academy of Marketing Science* 33 (4):461-475.
- Banerjee, S., and D. A. Soberman. 2013. Product development capability and marketing strategy for new durable products. *Intern. J. of Research in Marketing* 30:276–291.
- Barney, J. 1991. Firm Resources and Sustained Competitive Advantage. *Journal of Management* Vol. 17 (1):pp. 99 – 120.
- Baser, H., and P. Morgan. 2008. Capacity, Change and Performance : Study Report. In *European Centre for Development Policy Management*, 1-157.
- Bharadwaj, S. G., P. R. Varadarajan, and J. Fahy. 1993. Sustainable competitive advantage in service industries: A Conceptual Mode and Reseach Propositions. *Journal of Marketing; Oct 1993; 57, 4; 57 (4):83-99.*
- Brady, M. K., and J. J. Joseph Cronin. 2001. Customer Orientation Effects on Customer Service Perceptions and Outcome Behaviors. *Journal of Service Research* 3 (3):241-251.
- Broniarczyk, S. M., and A. D. Gershoff. 2003. The Reciprocal Effects of Brand Equity and Trivial Attributes. *Journal of Marketing Research* XL:161–175.
- Cao, Q., E. Gedajlovic, and H. Zhang. 2009. Unpacking Organizational Ambidexterity: Dimensions, Contingencies, and Synergistic Effects. *Organization Science* 20 (4):781–796.
- Cohen, W. M., and D. A. Levinthal. 1990a. Absorptive Capacity : A New Perspective on Learning and Innovation. *Administrative Science Quarterly* 35 (Technology, Organizations, and Innovation):128-152.
- Day, G. S. 1994. The capabilities of market-driven organizations. *Journal of Marketing* 58 (2):37-52.
- . 2002. Managing the market learning process. *The Journal of Business & Industrial Marketing* 17 (4):240-252.
- Day, G. S., and C. V. d. Bulte. 2002. Superiority in customer relationship management: consequences for competitive advantage and performance. In *Report No. 01–123, Cambridge, MA: Marketing Science Institute.*
- Dutta, S., O. Narasimhan, and S. Rajiv. 1999. Success in high-technology markets: Is marketing capability critical? *Marketing Science* 18 (4):547-568.
- Eisenhardt, K. M., and J. A. Martin. 2000. Dynamic capabilities: What are they? *Strategic Management Journal* 21 (10/11):1105-1121.
- Esteban, A., A. Millan, A. Molina, and D. M. Consuegra. 2002. Market Orientation in Service : Areview and Analysis *European Journal of Marketing* 36 (9/10):1003– 1021.
- Ferdinand, A. T. 2000. Manajemen Pemasaran : Sebuah Pendekatan Strategik. *Research Paper Series* 01 (Mark/01):1-55.

- . 2003. *Sustainable Competitive Advantage : Sebuah Eksplorasi Model Konseptual*. edited by S. P. M. N. M. Reseach Paper Series. Fakultas Ekonomi Universitas Diponegoro, Semarang.
- Ferdinand, A. T., and K. L. Batu. 2013. MAIsCAP-Marketing Architectural Isolating Capability As Antecedents For Success Of New Product Development. *Journal of Economics, Business and Accountancy Ventura* 16 (3):487 – 502.
- Foley, A., and J. Fahy. 2004. Towards a further understanding of the development of market orientation in the firm: a conceptual framework based on the market-sensing capability. *Journal Of Strategic Marketing* 12:219–230.
- Folinas, D., and S. Rabi. 2012. Estimating benefits of Demand Sensing for consumer goods Organisations. *Journal of Database Marketing & Customer Strategy Management* 19: 245 – 261.
- Foss, N. J. 1999. Networks, capabilities and competitive advantage. *Scandinavian Journal of Management* 15:1-15.
- Ghozali, I. 2011. *Model Persamaan Struktural : Konsep dan Aplikasi dengan Program AMOS 19.0* edited by IV. Semarang: Program S3 Ilmu Ekonomi Universitas Diponegoro.
- Hair, J. F., W. C. Black, B. J. Babin, and R. E. Anderson. 2010. *Multivariate Data Analysis*. edited by S. Edition: Pearson Prentice Hall.
- Henderson, R., and I. Cockburn. 1994. Measuring Competence? Exploring Firm Effects in Pharmaceutical Research. *Strategic Management Journal* 3712 (94):1-36.
- Hou, J.-J., and Y.-T. Chien. 2010. THE EFFECT OF MARKET KNOWLEDGE MANAGEMENT COMPETENCE ON BUSINESS PERFORMANCE: A DYNAMIC CAPABILITIES PERSPECTIVE. *International Journal of Electronic Business Management* 8 (2):96-109.
- Hsu, C.-W., H. Chen, and L. Jen. 2008. Resource linkages and capability development. *Industrial Marketing Management* 37:677–685.
- Hurley, R. F., and G. T. M. Hult. 1998. Innovation, Market Orientation, and Organizational Learning: An Integration and Empirical Examination. *Journal of Marketing* 62 (3):42-54.
- Jaworski, B. J., and A. K. Kohli. 1991. Supervisory Feedback : Alternative and Their Impact on Sales people's Performance and Satisfaction. *Journal of Marketing Research* 28 (2):190-201.
- . 1993. Market Orientation : Antecedents and Consequences. *Journal of Marketing* 57:53-70.
- Kandemir, D. 2005. A STUDY OF MARKET KNOWLEDGE COMPETENCE AS A SOURCE OF SBU PERFORMANCE, A DISSERTATION Submitted to Michigan State University in partial fulfillment of the requirements for the degree of DOCTOR OF PHILOSOPHY Department of Marketing and Supply Chain Management.
- Kohli, A. K., and B. J. Jaworski. 1990. Market Orientation: The Construct, Research Propositions, and Managerial Implications. *Journal of Marketing* 54:1-18.
- Komoditas Andalan dan Unggulan Kabupaten Brebes.
- Kotler, P. 2002. *Marketing Management, Millenium Edition*. Tenth Edition ed. New Jersey: Prentice-Hall, Inc.
- Kotler, P., and G. Armstrong. 2012. *Principles of Marketing*. edited by P. P. H. 14th ed, New Jersey.
- Kusmantini, T., Y. Utami, and T. Wahyuningsih. 2011. Analisis Faktor-Faktor Kontekstual Proses Pengembangan Produk dan Dampaknya pada Kualitas Produk Baru. *Karisma* 5 (2):116-128.
- Langerak, F., E. J. Hultink, and H. S. J. Robben. 2004. The Impact of Market Orientation, Product Advantage, and Launch Proficiency on New Product Performance and Organizational Performance. *J PROD INNOV MANAG* 21:79–94.
- Li, L. X. 2000. An Analysis of Sources of Competitiveness and Performance of Chinese Manufacturers. *International Journal of Operation and Production Management* 20 (3):299-315.
- Li, T., and R. J. Calantone. 1998. The impact of market knowledge competence on new product advantage: Conceptualization and empirical examination. *Journal of Marketing* 62 (4):13-29.
- Li, Y.-H., and J.-W. Huang. 2012. Ambidexterity's mediating impact on product development proficiency and new product performance. *Industrial Marketing Management* 41:1125–1132.
- Lin, C., and M.-L. Hsu. 2007. A GDSS FOR RANKING A FIRM'S CORE CAPABILITY STRATEGIES. *The Journal of Computer Information Systems* 47 (4):111-130.
- Lubatkin, M. H., Z. Simsek, Y. Ling, and J. F. Veiga. 2006. Ambidexterity and Performance in Small - to Medium-Sized Firms: The Pivotal Role of Top Management Team Behavioral Integration. *Journal of Management* 32 (5):646-672.
- MartINETTE, L. A., and A. Obenchain-Leeson. 2012. The Relationship Between Learning Orientation And Business Performance And The Moderating Effect Of Competitive Advantage : A Service Organization Perspective. *Journal of Service Science* 5 (1):43-58.

- Maydeu-Olivares, A., and N. Lado. 2003. Market orientation and business economic performance : A mediated model. *International Journal of Service Industry Management* 14 (3):284-309.
- Mazaira, A., E. Gonzalez, and R. Avendano. 2003. The role of market orientation on company performance through the development of sustainable competitive advantage: The Inditex-Zara case. *Marketing Intelligence & Planning* 21 (4/5):220-229.
- Menguc, B., and S. Auh. 2006. Creating a Firm-Level Dynamic Capability through Capitalizing on Market Orientation and Innovativeness. *Journal of the Academy of Marketing Science* 34 (1):63-73.
- Namjoyan, M., D. A. N. Esfahani, and D. F. A. Haery. 2013. Studying the Effects of Customer Relationship Management on the Marketing Performance (Isfahan Saderat Bank as a case Study). *International Journal of Academic Research in Business and Social Sciences* 3 (9):302-314.
- Narver, J. C., and S. F. Slater. 1990a. The Effect of a Market Orientation on Business Profitability. *Journal of Marketing* 54 (4):20-35.
- Neill, S., D. McKee, and G. M. Rose. 2007. Developing the organization's sensemaking capability: precursor to an adaptive strategic marketing response. *Industrial Marketing Management* 36 (6):31-44.
- Newbert, S. L. 2008. VALUE, RARENESS, COMPETITIVE ADVANTAGE, AND PERFORMANCE: A CONCEPTUAL-LEVEL EMPIRICAL INVESTIGATION OF THE RESOURCE-BASED VIEW OF THE FIRM. *Strategic Management Journal* 29:745-768.
- Nowlis, S. M., and I. Simonson. 1996. The effect of new product features on brand choice. *Journal of Marketing Research* 33 (1):36.
- Olavarrieta, S., and R. Friedmann. 1996. Market orientation, knowledge-related resources and firm performance. *J Manag Stud* 33:429-451.
- Pelham, A. M. 1997. Mediating influences on the relationship between market orientation and profitability in small industrial firms. *Journal of Marketing Theory and Practice* 5 (3):55.
- Peteraf, M. A. 1993. The Cornerstones of Competitive Advantage : A Resource Based View. *Strategic Management Journal* 14, No. 3:179-191.
- Peters, R. C. 2007. CORPORATE SOCIAL RESPONSIBILITY AND STRATEGIC PERFORMANCE: REALIZING A COMPETITIVE ADVANTAGE THROUGH CORPORATE SOCIAL REPUTATION AND A STAKEHOLDER NETWORK APPROACH, A Dissertation submitted to the Faculty of The College of Business in Partial Fulfillment of the Requirements for the Degree of Doctor of Philosophy, Florida Atlantic University, Boca Raton, FL.
- Porter, M. E. 1985. *Competitive advantage: Creating and sustaining superior performance*. edited by N. Y. F. Press.
- . 1990. *Competitive Advantage*. New York: The Free Press.
- Ramaswami, S. N., R. K. Srivastava, and M. Bhargava. 2009. Market-based capabilities and financial performance of firms: insights into marketing's contribution to firm value. *J. of the Acad. Mark. Sci.* 37:97-116.
- Raphael, A., and P. J. Schoemaker. 1993. Strategic Asset and Organizational Rent. *Strategic Management Journal* 14, 1:33.
- Reed, R., and R. J. DeFillippi. 1990. Causal Ambiguity, Barriers to Imitation, and Sustainable Competitive Advantage. *The Academy of Management Review* 15 (1):88-102.
- Robert M., G. 1991. The Resourced – Based Theory of Competitive Advantage : Implications for Strategy Formulation. *California Management Review, Vol. 33, pp. 114. 33:114.*
- Rumelt, R. P. 1991. How Much Does Industry Matter. *Strategic Management Journal* 12:167-185.
- Russo, M. V., and P. A. Fouts. 1997. A resource-based perspective on corporate environmental performance and profitability. *Academy of Management Journal* 40 (3):534-559.
- Seogoto, E. S. 2010. SUMBER KEUNGGULAN BERSAING, STRATEGI PEMASARAN PENGARUHNYA TERHADAP KEUNGGULAN POSISIONAL DAN KINERJA PEMASARAN PTS. *Majalah Ilmiah UNIKOM* 11 (1):3-14.
- Sethi, R. 2000. New product quality and product development teams. *Journal of Marketing* 64 (2):1-14.
- Shahrokh, Z. D., J. S. Sedghiani, and V. Ghasemi. 2012. Analyzing the influence of customer attitude toward brand extension on attitude toward parent brand. *INTERDISCIPLINARY JOURNAL OF CONTEMPORARY RESEARCH IN BUSINESS* 3 (9):1133-1148.
- Sinkula, J. M., W. E. Baker, and T. Noordewier. 1997. A framework for market-based organizational learning: Linking values, knowledge, and behavior. *Journal Academy of Marketing Science* 25 (4):305-318.

- Slater, S. F., and J. C. Narver. 1995. Market orientation and the learning organization. *Journal of Marketing* 59 (3):63.
- Soliman, H. S. 2011. Customer Relationship Management and Its Relationship to the Marketing Performance. *International Journal of Business and Social Science* 2 (10):166-182.
- Song, X. M., and M. E. Parry. 1997. A cross-national comparative study of new product development processes: Japan and the United States. *Journal of Marketing* 61 (2):1.
- Srivastava, R. K., T. A. Shervani, and L. Fahey. 1998. Market-Based Assets and Shareholder Value: A Framework for Analysis. *Journal of Marketing* 62:2-18.
- Srivastava, R. K., T. A. Shervani, and L. Fahey. 1999. Marketing, Business Processes, and Shareholder Value: An Organizationally Embedded View of Marketing Activities and the Discipline of Marketing. *Journal of Marketing* 63:168-179.
- Suherna. 2014. Membangun Kapabilitas Penetrasi Pasar Berkarakter Familiaritas Untuk Meningkatkan Kinerja Pemasaran, Program Studi Doktor Ilmu Ekonomi, Universitas Diponegoro, Semarang.
- Sun, P.-C. 2010. Differentiating high involved product by trivial attributes for product line extension strategy. *European Journal of Marketing* 44 (11/12):1557-1575.
- Teece, D. J., G. Pisano, and A. Shuen. 1997. Dynamic Capabilities and Strategic Management. *Strategic Management Journal* 18 No.7: 509-533.
- Thakur, R. 2005. CUSTOMER SATISFACTION, BEHAVIOR INTENTION, ATTITUDE, AND KNOWLEDGE: FOCUS ON THE ANTECEDENTS OF RELATIONSHIP SHARE IN THE CONTEXT OF CUSTOMER RELATIONSHIP MANAGEMENT (CRM), A Dissertation Submitted in Partial Fulfillment of the Requirements for the Doctor of Philosophy Degree Department of Marketing in the Graduate School Southern Illinois University Carbondale.
- Thomas, J. B., S. M. Clark, and D. A. Gioia. 1993. Strategic sensemaking and organizational performance: Linkages among scanning, interpretation, action, and outcomes. *Academy of Management Journal* 36 (2):239-270.
- Tian, J., K. Wang, Y. Chen, and B. Johansson. 2010. From IT deployment capabilities to competitive advantage: An exploratory study in China. *Inf Syst Front* 12:239–255.
- Tomita, J. 2009. New Product Development and Evaluating Capabilities: The Case of the Material Industry. *Annals of Business Administrative Science* 8: 43–54.
- Tooksoon, P., and O. Mohamad. 2010. Marketing Capability and Export Performance: the Moderating Effect of Export Dependence. *THE SOUTH EAST ASIAN JOURNAL OF MANAGEMENT* IV (1):39-52.
- Ulrich, D. 1991. Organizational Capability: Creating Competitive Advantage. *The Executive* 5 (1):77-92.
- Ulrich, K. T., and S. D. Eppinger. 2004. *Product Design and Development* edited by M. H. 3rd Edition.
- Vesalainen, J., and H. Hakala. 2014. Strategic capability architecture: The role of network capability. *Industrial Marketing Management* 43:938–950.
- Voss, G. B., and Z. G. Voss. 2000. Strategic Orientation and Firm Performance in an Artistic Environment. *Journal of Marketing* 64: 67-83
- Wang, C. L., and P. K. Ahmed. 2004. The development and validation of the organisational innovativeness construct using confirmatory factor analysis. *European Journal of Innovation Management* 7 (4):303-313.
- Weick, K. E., K. M. Sutcliffe, and D. Obstfeld. 2005. Organizing and the Process of Sensemaking. *Organization Science* 16 (4):409–421.
- Wernefelt, B. 1984. A Resourced Based View of The Firm. *Strategic Management Journal* 5:171-180.
- Winter, S. G. 2003. Understanding dynamic capabilities. *Strategic Management Journal* 24 (10):991-995.
- Zahay, D. L., and R. B. Handfield. 2004. The role of learning and technical capabilities in predicting adoption of B2B technologies. *Industrial Marketing Management* 33:627– 641.
- Zahra, S. A., and S. S. Das. 1993. Innovation Strategy and Financial Performance in Manufacturing Companies: an Empirical Study. *Production and Operation Management* 2 (1):15-37.

## Green Chittagong, Clean Chittagong: How collaboration of Government & Business can create a better place for all

Jalil, Mehedi Shahnewaz \*

\* Lecturer, Department of Business Administration, Southern University Bangladesh, Chittagong  
E-Mail address: [msjalil298@gmail.com](mailto:msjalil298@gmail.com) ; Phone: (+880) 1716 303131, (+880) 1972 303131

### Abstract

Government and Businesses are related to each other for proper maintenance of business environment in a country. It creates new opportunities for the businesses and government. Sometimes campaigns initiated by the government organizations create a positive impact in the society as businesses and people get a favorable business environment and aware about their own social responsibilities. This paper tries to explain the situation with the message: Green Chittagong, Clean Chittagong of the port city of Bangladesh. The initiative was taken by Chittagong Metropolitan Police (CMP) with dynamic coordination of the Police Commissioner Abdul Jalil Mondal and carried out by other government organizations, mass people and the business organizations. The initiatives are: cleaning footpaths, roads & drains of the city; clearing footpaths from unwanted usurpers & rehabilitating them in other places; ensuring an Organized and Systematic Management of Wastes (OSMW); ensuring Flood Management System (FMS) and motivating the business organizations to beautify the city. Main goal of this initiative is to engage mass people into the development activities, businesses to ensure corporate social responsibilities (CSR) and to ensure a healthy living environment for all. This initiative can create collaboration with the government and businesses in an effective way of doing things.

**Keywords:** *Government & Businesses, Private-Public Partnership, Corporate Social Responsibility*

### 1. Introduction

Government and businesses plays an integral part in the development of a country. Government is in charge of establishing rules and regulations to ensure a smooth way of doing business in both home and abroad; while businesses can take advantage from the governments in running their operations. This mutual partnership works in a win-win situation for both of the parties. This joint cooperation is known as Public-Private Partnership (PPP) in many countries. Recently, it has been seen that if government and businesses can work together it can reap benefits for a country as shown by J.A. Gómez-Ibáñez and J.R. Meyer (1993) who found that Countries worldwide with PPP experience include Australia, Germany, Hungary, Italy, Japan, Korea, Spain, the USA, and the UK. Between 1985 and 2004, there were a total of 2,096 PPP projects worldwide with a total capital value of nearly US \$887 billion (AECOM Consultant Inc. 2005). For Bangladesh, Public-Private-Partnership is relatively a new concept. During its first forty years, the country has gone through rigorous nationalization followed by vigorous privatization. Now the country is scoring positive results and was able to meet most of the Millennium Development Goals (MDG) set by the United Nations that expires this year. The country was included in the Next 11 powerful economies of the world predicted by Goldman Sachs back in the year 2005. Now various reports also suggests positive goals to be attained by the country as it seeks to become one of the developed nations by the year 2041 as stated by the Prime Minister in her speech in the National Parliament. The country is working towards the goal. But this goal can be attained only if businesses and government both play their role effectively in each of their sectors and work together. In Chittagong, the port city and the business capital of the country this dimension is working like magic and Chittagong is becoming a role model for other cities to follow. The plot is simple, in order to do business effectively and ensuring environmental sustainability both government and businesses should work closely. In Chittagong, Chittagong City Corporation (CCC), Chittagong Development Agency (CDA), and Chittagong Metropolitan Police (CMP) are working altogether to create a better place for all. This joint cooperation from the government agencies and with the help of the business magnet in the city is creating all sorts of changes in the city. Starting only last year after Chittagong Metropolitan Police came aside their regular duties as enforcing law and order situation and took the initiative to ensure a clean Chittagong led by their new dynamic Commissioner Abdul Jalil Mondal; the city is going in some positive change as societies and communities all following the initiative.



## **2. Background of the Study**

### **2.1 Statement of the Problem**

Bangladesh was a war torn country. In 1971 Bangladesh became independent from the rulers of West Pakistan and formed an independent nation. Situated in the South Asian region the country has a rich history of culture and business. The 1, 47, 570 square kilometer country had wealth and a powerful economy and was one of the 6<sup>th</sup> largest economy in its prime back in the 14<sup>th</sup> and 15<sup>th</sup> century. The way to enter Bangladesh was through the City of Chittagong. Thus the city is also called the gate to enter Bangladesh. Once ruled by the Arakans the city was extended in the Burma presently known as Myanmar. The history of business here is old as the country used to do business through the port. Chittagong is also a hilly area and holds various beauties itself. The city is historically important and was approached by various Muslim preachers. The city thus is called “city of 360 aulias (preachers).” The city is also the second largest in size and economy after the capital Dhaka.

The city in recent years has been developed a lot. But with increasing number of population is facing challenges. The sanitation, waste management, flood management and crime problems is some of the challenges that the city has faced in the past few years. In order to bring a positive change and development in the city the officials are working together closely. There are government organizations working to develop the city known as Chittagong City Corporation (CCC), Chittagong Development Agency (CDA). To ensure law and order enforcement Chittagong Metropolitan Police (CMP) is also there. To attract businesses the government agencies role is vital. In Chittagong, a number of large corporations operating in Bangladesh have their factories and offices like: M.M. Ispahani, PHP Group, BSRM, KSRM, RSRM all steel mills, ship breaking yards, Glaxo Smith-Kline and so on. So with the existing problem in hand these government organizations must work together with the businesses if they want to ensure a quality and sustainable environment in the city.

### **2.2 Objective of the Study**

This study follows the following objectives:

- (a) To analyze Policies taken in the previous years in the development of the city of Chittagong
- (b) To illustrate the current situation of development in the Chittagong city with its slogan: Clean Chittagong, Green Chittagong
- (c) To critically analyze the steps taken by the government agencies and businesses to develop the city with environmental sustainability and better business environment
- (d) To suggest new opportunities and challenges in light of the recent developments

### **2.3 Literature Review**

The literature followed in this study circles within the business environment, environmental sustainability, green business and Corporate Social Responsibility.

#### **2.3.1 Environmental Sustainability:**

As stated, the process of economic growth must be equitable as well as environmentally sustainable. The environmental efficacy deteriorates when the environment is degraded and the environmental balance disturbed through overuse, pollution, deforestation, and the consequences of greenhouse gas emissions. Environmentally sound development calls for actions to restore and maintain environmental health while pursuing socio-economic development. Internationally, there is broad consensus that the environment and production systems should be tailored to minimize damage to the environment to ensure the sustainability of development. Sound environment is a multisectoral concern and it contributes towards capacity building of other sectors and helps to facilitate effective coordination among sectors. Such an integrated pathway is crucial from the perspective of longer term development sustainability and for leaving the environment, as inter-generational equity considerations demand, in such a state that the future generations can meet their needs. (Perspective Plan of Bangladesh 2010-2021, Government of Bangladesh)

### 2.3.2 Corporate Social Responsibility

From the business perspective these issues had been met time to time from various philanthropists; operating their businesses both in the country and abroad. Bangladesh has a long history of philanthropic activities from time immemorial. These philanthropic activities included donations to different charitable organizations, poor people and religious institutions [Miyan 2006]. The term popularly known in today's world as Corporate Social Responsibility (CSR). The CSR World Wide portal conclude that, in Bangladesh Civil society, businesspeople and politicians view CSR in terms of philanthropy, particularly in the schools and the healthcare sector. This focus is also rooted in the country's Islamic tradition of calling upon those with more resources to help the disadvantaged. Accordingly, companies are expected, most of all, to engage in charitable works, for example by providing donations or in-company training programs [The CSR World Wide portal, 2012].

Though CSR is a relatively new concept in Bangladeshi corporate culture, awareness of corporate social reporting has rapidly increased. All companies need to consider their CSR for two basic reasons. Firstly, there is intensifying pressure from stakeholders to do so [Belal, 2001 cited Azim 2011]. Any company that does not develop and promote its CSR policy to all stakeholders will face increasing threats to its reputation. Secondly, because it makes sound business sense, CSR enhances the reputation of an organization, brings in new business and improves stakeholder return [Kabir, 2003 cited Azim 2011]. In recent years there is considerable pressure from various agencies for companies to act responsibly and be accountable for the impacts they have on social, political and ecological environments. Companies are also expected to participate in solving social problems, such as poverty and infrastructure. These motivations also influence businesses to engage in joint cooperation with the government to develop the society and environment in which people live in.

### 2.3.3 Green Business

The third literature brings Green Business or Sustainable business, is an enterprise that has minimal negative impact on the global or local environment, community, society, or economy—a business that strives to meet the triple bottom line. Often, sustainable businesses have progressive environmental and human rights policies. In general, business is described as green if it matches the following four criteria:

- a) It incorporates principles of sustainability into each of its business decisions.
- b) It supplies environmentally friendly products or services that replaces demand for nongreen products and/or services.
- c) It is greener than traditional competition.
- d) It has made an enduring commitment to environmental principles in its business operations.

[Cooney, S. 2009]

Corporate sustainability strategies can aim to take advantage of sustainable revenue opportunities, while protecting the value of business against increasing energy costs, the costs of meeting regulatory requirements, changes in the way customers perceive brands and products, and the volatile price of resources. Not all eco-strategies can be incorporated into a company's Eco-portfolio immediately. The widely practiced strategies include: Innovation, Collaboration, Process Improvement and Sustainability reporting.

- a) Innovation & Technology: This introverted method of sustainable corporate practices focuses on a company's ability to change its products and services towards less waste production and sustainable best practices.
- b) Collaboration: The formation of networks with similar or partner companies facilitates knowledge sharing and propels innovation.
- c) Process Improvement: Continuous process surveying and improvement is essential to reduction in waste. Employee awareness of company-wide sustainability plan further aids the integration of new and improved processes.
- d) Sustainability Reporting: Periodic reporting of company performance in relation to goals; these goals are often incorporated in to the corporate mission. [Wikipedia, 2015]

For this study the collaboration strategy is mainly shown.

## **2.4 Methodology**

This study has been prepared on the basis of primary as well as secondary data and thus is a qualitative research. Primary data was gathered through face to face conversation and interview with government officials of Bangladesh, various CEOs and Chairpersons from various business & corporate affiliations. Besides this, information has been gathered by talking to a number of people from the grass root level. The pertinent secondary information was accumulated from relevant articles, newspapers, different position papers and action plans of the government, and relevant websites. This is an exploratory research in nature and a significant portion of the information has been gathered from literature review.

## **2.5 Limitations**

As this study has been conducted on the basis of mostly the secondary data, it poses a limitation. Besides, interviews conducted with various professionals may include their emotions. Some commented from a neutral point of view but to get the true nature of the respondents more in depth analysis would have been needed. The time frame on which the study is conducted is only of 6 months. The idea that is presented is also has the same duration. Consistency will ensure that the idea is working properly. Finally, limitations of researcher and the research design are also present. No advanced statistical tools are being used and the research is qualitative in nature. This study has the potential to be more significant if an in-depth quantitative research is being conducted.

## **3. Analysis**

### **3.1 Private-Public Partnership (PPP)**

PPP is a contractual agreement formed between public agency and private sector entity to meet public demand for goods and services, where public sector maintains an oversight and quality assessment role and private sector is involved in delivery of service or project. In PPP Risks, Rewards and Responsibilities (the 3Rs) are shared judiciously, according to their competence, by both public and private sectors.

#### *3.1.1 Types of Private Public Partnership*

The possibility of Public-Private partnership is wide. A wide range of projects may be undertaken under PPP. Some of the infrastructure business projects and social projects that can work well in PPP are:

- a) Telecommunication
- b) Power
- c) Port development
- d) Highways and expressways
- e) Oil and gas
- f) Airports, terminals
- g) Tourism
- h) Water supply, sewerage and drainage
- i) Industrial estates and parks, city and property development
- j) Land reclamation, dredging, etc
- k) Service sectors e.g. health and educational facilities
- l) Environmental, industrial and solid waste management
- m) Railways
- n) Other urban, municipal and rural infrastructure; and any other infrastructure Project of similar nature.

#### *3.1.2 Rationale for Private Public Partnership*

The rationales for undertaking development project on PPP mode and the advantages of undertaking social and development project on PPP mode are the following:

- a) Increased access to (private) capital investments, and effective use of capital
- b) Access to increased technical and managerial capabilities in the sector

- c) Increasing operating efficiency
- d) Increasing customer focus
- e) Reducing the need for subsidies

### 3.1.3 Risks of Private Public Partnership

General restraints on PPP in the water sector, from a private sector point of view, are the following and these are to be addressed by the government for its success:

- a) Country risk, particularly credit risk and political risks
- b) Lack of appropriate legal framework
- c) Commercial risk (Inability to pay by the customers, people or the government)
- d) Social opposition and resistance to private sector involvement
- e) Lack of track record of PSP of the country

[Islam, A.K.M.R. 2009]

## 3.2 An overview of the City of Chittagong

Chittagong is a port city situated in the southern region of Bangladesh. The city is surrounded by hills to the east and the Bay of Bengal in the south - west. One of the most beautiful rivers in Bangladesh, the Karnaphuli River flows into the Bay of Bengal through this city. Chittagong Municipality was upgraded to City Corporation in July 1990. It is the second largest city corporation with an area of 168.07 sq. km. The 2001 national census determined that the Chittagong statistical metropolitan area had a population of approximately 3.2 million in approximately 430,000 households. According to the 2001 census about 55 percent of the population is male. Literacy rate (more than 7 years old) according to the 2001 census is 65 percent. The average household size is 4.

Chittagong's status as a port city has attracted significant industrial development. Most of the industries have been built near the Bay of Bengal and the Karnaphuli River. Industries include ship - breaking, steel production, food processing, textiles, petroleum products, chemical manufacturing and many others. Bangladesh's only oil refinery (Eastern Refinery of Bangladesh) Station is also located in Chittagong.

## 3.3 Ongoing Development Policies

The two government organizations that are in charge of the development of Chittagong are Chittagong City Corporation (CCC) and Chittagong Development Authority (CDA). These two organizations have plans and projects under them and working side by side for the development of structural, transportation and other areas of the city.

### 3.3.1 Chittagong City Corporation

Chittagong City Corporation (CCC) is a self-governing organisation which governs the municipal areas of Chittagong and some adjoining areas of south-eastern Bangladesh. Chittagong City Corporation descended from the name of Chittagong Municipality which was founded on June 22, 1863. Currently the City Corporation area is divided into 41 wards. Alhaj M. Manjur Alam was elected in the last City Corporation election held in 2010 although he left his post in March, 2015 and a new election will be held next month. The activities and development initiatives of the corporation are as follows:

- a) University Managed by City Corporation: With a view to the demand of time and ensure people's participation to realize the goal of right to education Chittagong City Corporation has taken- the basic and exceptional program of expansion and qualitative improvement of the education. It's established Premier University is one of the popular universities in Chittagong.
- b) Health care: One of the multifarious programs undertaken for building a Healthy nation and ensuring medical services to the city dwellers. In order to take these service-oriented programs to the doorsteps of the City dwellers, Chittagong City Corporation has been implementing programs to ensure maternal and child health care. Besides giving outdoor services to the patients, Chittagong City Corporation runs 22 no. Charitable dispensaries and primary health care centers.
- c) Street Lighting: Chittagong City Corporation also provides the lighting services for the Chittagong City. They also maintain all traffic signal lights and to keep in order by supplying required materials.

- d) City Beautification: Chittagong City Corporation also works to beautify the city with roadside gardens, wall graffiti, and decoration on special occasions such as World Cup event in Bangladesh.
- e) Mortuary: Chittagong City Corporation provides some special type of vehicle to carry the dead body and established two separate Incineration plant with modern gas burner for dispose-up Hindu and Buddhist dead body.
- f) Birth, Death & Nationality Certificate: Chittagong City Corporation is the only organization in the City where all Births and Deaths are registered.
- g) Trade License and Tax: Chittagong City Corporation also collects taxes and gives out trade licenses to business organizations.

Besides these regular works; urban primary healthcare, solid waste management are the ongoing projects. The city corporation also plans on projects of elevated expressway, marine driveways, two level highways, five star hotels, 10 megawatt power generation plant, high rise dormitories, development of garments village, resort facilities, satellite town projects, observation tower, liberation monument, and city disaster prepare plan. [Chittagong City Corporation Website, 2015]

### 3.3.2 Chittagong Development Authority

Chittagong Development Authority (CDA) is the statutory planning and development authority for the Chittagong Metropolitan Area (CMA), was created in 1959 under the provision of the CDA Ordinance 1959, established by Bangladesh Government in order to ensure the planned and systematic growth of the city. The development of Chittagong has substantial impact on the overall development of Bangladesh. The Chittagong Development Authority (CDA) was established to provide Development; Improvement and Expansion of the town of Chittagong and certain areas in its vicinity. Major Role of CDA includes development control, development promotion and development permission.

The major functions of this authority are as follows:

- a) Preparation of master plan for Chittagong city and the area in the vicinity and its continuous review
- b) Preparation of short term and long-term development programs for improvement and expansion of Chittagong city. This includes construction of new roads, widening and improvement of major city roads, construction of shopping complex, development of industrial and residential estates and commercial plots and other necessary urban developments
- c) Exercising planning control over the structure plan as per provision of CDA Ordinance and Govt. approved Master Plan
- d) Development control within the preview of Bangladesh Building Construction Acts, 1952 with its subsequent revisions

The major components of the authority are as follows:

- a) Structure Plan (1995-2015)
- b) Urban Development Plan (1995-2005)
- c) Detailed Area Plan (Up to 2015 )
- d) Long Term Development Strategy for Traffic and Transportation for Chittagong (1995-2015)
- e) Storm Water and Drainage Master Plan (1995-2015)

Besides these, the authority also works on infrastructure development, roads & traffic congestion control, residential/housing facility, commercial zone development and tourism.

[Chittagong Development Authority Website, 2015]

### 3.3.3 Other organizations

Besides these two main development organizations operated by the government in Chittagong there are other government organizations also working such as: Chittagong Metropolitan Police (CMP), Water and Sewerage Authority (WASA), Chittagong Port Authority (CPA) etc.

### **3.4 Clean Chittagong, Green Chittagong – A new leash**

People want change; but if they're being told that they have to change themselves then they don't always agree. Telling somebody to change is easy but changing the inner self is difficult. It's easy to blame the people for not doing something, but doing it on their own is always difficult. But in order to encourage the community spirit this is essential. The clean Chittagong initiative came from this concept. It's the concept that tells people to change their motives, their attitudes and their spirit to create a better environment. If the city is clean then people will have a fresh mind, they will refrain from doing bad things and eventually will create a more favorable environment for all. This simple message was carried out by the Chittagong Metropolitan Police on October 24<sup>th</sup> 2014 when a number of Police members came out of their regular duties of law enforcement and took broomsticks in their hands and cleaned the city on their own led by the new dynamic police commissioner Abdul Jalil Mondal. On that day he urged the people of Chittagong to enhance their community spirit and arrange to clean their places by themselves. While attending the campaign the CMP Commissioner said, "CMP took the initiative in a bid to create awareness among the people on community efforts and it is also our duty. We always admit that government and city corporations are only responsible to clean the garbage dumps lying all over the city. But it would be better for all of us if people came up with their responsibilities and dump their wastes in dustbins." [Dhaka Tribune, 2014] His voice received positively by the people and since then Chittagong is going through a lot of positive changes. It's not all. Chittagong Metropolitan Police is also taking other steps to ensure a better Chittagong. These are:



Image 1: Commissioner with his associates cleans the streets

#### *3.4.1 Rescuing the roadsides from unwanted usurpers*

The road from Chittagong International Airport to the main city had a number of roadside shops which sat everyday from morning to night creating a huge traffic jam. Police Commissioner wanted to free the road. So he went there and had a meeting with the people. Local people placed their demands and he also told what he wants from them. He gave people one week to leave the road and reassigned them in other places and weekend markets. People listened and within one week the roads are cleared of the unwanted usurpers and traffic jam became less intense. Before it almost took 90 to 120 minutes to reach airport from the city but now it only takes 60 minutes because of less traffic congestion in the area.

#### *3.4.2 Community Development Program*

Chittagong Metropolitan Police encouraged community development program thinking from two perspectives. One is to encourage people to clean the place of their living by themselves; and another is to ensure that no drug, gambling and other illegal events can take place. People responded well. Police had been given an extra duty beside their normal duty. When they patrol they will look for any wastes in the roadsides or in front of the shops. If they find any, they'll notify the house owner or shop owner immediately to clean it up. Nobody went outside of the voice raised by their commissioner and cleaned it up themselves. From the petty shopper to owner of the multistoried apartment everybody cleaned on their own. The second encouragement was to stop any illegal activities in the community. People gave information about the illegal activities and they're rewarded with it. The accused are



arrested and taken to the custody. Bangladesh has facing a political unrest since the beginning of this year. Almost all the country is affected but the city of Chittagong is not one of them. Instead, a number of criminals who have done unlawful activities are being handed to the police by the mass people. Law and order situation in Chittagong is also tolerable and people can move freely whenever they want and wherever they want. Political parties also accepted the way of the new commissioner and listen to his initiatives.

### *3.4.3 Removing illegal billboards*

There are 422 illegal billboards in the Chittagong city alone. [Bangladesh Observer, 2015] Chittagong Metropolitan Police along with the help of the Chittagong City Corporation has taken the initiative to remove these billboards from the city. The work was laid down previously last year in the month of November but the work has been rejuvenated this year's January. The commissioner was personally present in the removal of the billboards. The initiative was positively received by the mass people. There are a number of people who came to stop the initiative but they're later charged with obstructing Police work and been taken into custody. Some business people were unhappy with the decision but a large number of businesses appreciate the initiative.



Image 2: Removal of a billboard from a prime point of Chittagong City

### *3.4.4 Rehabilitating Roadside businesses*

In the industrial areas of Kalurghat, Chittagong, there are a number of shops that are situated just besides roads. This creates a harmful situation for the vehicles and the area was more prone to road accidents. Police Commissioner went there and held meeting with the industrialists. Then he held meeting with the shop owners and promised them to build a separate complex with the help of the industrialists. Industrialists agreed and the work is almost finished. If the project is completed then this will rehabilitate more than 400 petty shopkeepers.

### *3.4.5 Awareness campaigns*

Chittagong Metropolitan Police Commissioner also became involved in various awareness raising campaigns. He went in ward to ward of the city corporation and held meetings with people, encouraged them to help police. He also went to mosques, temples and urged people to become ideal person for the society. In his doing he encouraged people to adapt cleanliness, improve personality and work hard. He became very popular to all kinds of people, from business persons, to students and the mass people for this. Everybody in Chittagong knows him by his name and likes him a lot.



Image 3: Awareness campaign by Commissioner

#### *3.4.6 City Beautification*

Chittagong Metropolitan Police has also initiated city beautification in a new way involving business organizations into it. Roadside gardens and isles become more beautiful because of it. Police commissioner motivates the tiles businesspersons to beautify the cities and they responded well. Most of the isles of the cities are covered in tiles now. Also people are taking initiatives themselves to raise gardens in it.

#### *3.4.7 Self Development programs for Police Officials*

Chittagong Metropolitan Police has taken initiative to develop the state of the police officials from the top to bottom. For that reason, weekly meditation and discussion session has been conducted every Friday evening chaired by the Chairperson of Police Female Welfare Association Shahida Jalil. The program is organized by Quantum Foundation, a non-profit organization operating in Bangladesh which is working to promote self and societal development of a human being since 1993.

#### *3.4.8 Night Patrol from high officials*

Just like Khalifa Umar (R) used to patrol in disguise at night to see how his subjects are doing and what is their condition, Police Commissioner also started to patrol one evening in disguise. He went to different places, talked to different people, went to police officials and evaluated their activities. Purely from the service point of view these kinds of initiative attracted eyes of the general people and they also helped the Commissioner with his promise: to keep the city clean. [CTG News, 2015]

#### *3.4.9 Dredging the canals with joint cooperation of Chittagong City Corporation and Chittagong Development Authority*

Almost every year Chittagong faces flood due to improper drainage system. The canals are not properly dredged and the aftermath is rise of water during rainy season starting in April. This term the works of Metropolitan Police Commissioner has attracted eyes of others and the commissioner also vows to work in favor of the problem and wants to remove it. Thus the other 2 organizations are now working closely together to remove the problem once it for all. The work is ongoing and the results will be visible during the rainy season starting next month.

#### *3.4.10 Result of the efforts*

The initiatives have reached its 6<sup>th</sup> month since last October. The first wave was a bit challenging. People are not accustomed with changing on their own; but motivation speeches in different wards and areas made people concern about their own responsibilities. This in turn has created a positive uplift of the mass people. The commissioner is a person who related his speeches to every religion, every sect, and every occupation. He urged everyone to join the cause: to ensure a better living environment. From businesses to households everybody took him positively. Everybody understood that this man wants to build a community appeal and this man does what he says.

Cycle seller Hasan says,

***“The new Commissioner Mondal has us all concerned. Now we know we can’t leave any wastes outside our cycle store. He lets his patrol out here at any time. It’s a good thing; at least we are not alone doing it; everybody’s doing it.”***

Police Sub Inspector Ruhul Amin says,



***“The new commissioner has put the name of Police in a different dimension. Everybody respects us now. His work is cheered by all when people talk to us. Personally I feel him a lot and want to work with him.”***

2<sup>nd</sup> Grade Student Sadati says,

***“Our commissioner Mondal is awesome. When I grow young I want to be just like him!”***

Chairman of Pacific Jeans Mr. Nasir Ahmed says,

***“Mr. Mondal is doing great things in Chittagong. People love him, we love him. It’s also affecting our business. Foreign buyers are coming in such a difficult situation of the country when we told them Chittagong is free from this because we have a dynamic leader now.”***

Managing Director of M.N. Group Mohiuddin Ahmed Minto says,

***“Don’t get it as I am saying something extraordinary, but what Mr. Mondal does here is truly great. My workers are happy, the environment is good, people feel safer. They can count on the commissioner. This is something that you don’t always get. I salute him for his efforts.”***

Lecturer of East Delta University Shehrin Ahmed says,

***“In this difficult situation when every other area is somehow affected in political violence our Chittagong is much safer. It really is good for the city and its people.”***

Like these professionals people from all sects, all religions and all occupation has a positive mindset about the new commissioner and his works. Due to research purpose only a handful of comments has been presented in this case.

#### *3.4.11 Business Impact*

Businesses have accepting the new trend of doing business in Chittagong now. The government development organizations namely Chittagong City Corporation, Chittagong Development Authority and Chittagong Metropolitan Police are working altogether and the work is ongoing. Thus the businesses are becoming more environmentally conscious and had a real belief that change is coming. Businesses are doing more CSR activities than before and new business opportunities are being created. New innovative type of businesses, green business practices and entrepreneurship opportunities are being created. Most of these businesses have a real faith in the new dynamic leadership of Police Commissioner as the commissioner himself has a good relationship with the business organizations as well as mass people. The foreign buyers are also becoming more interested in new opportunities it creates. The business in Chittagong is thus booming.

## **4. Challenges and Opportunities**

As stated before, Chittagong is a port city of Bangladesh and the most prime spot of doing business after the capital Dhaka, the opportunities lie in every sphere of the city. It has been said that in Chittagong money flies, if you can catch them. The big industrialists, business persons, rich people all live in Chittagong. The opportunities that lie in front of Chittagong are:

- a) Chittagong is a big city with top business magnets of Bangladesh. They can pose to be a great chance of doing businesses with.
- b) Chittagong is developing, a number of flyovers have been constructed recently and work is ongoing on three more. This can create easy movement between the parts of the city and make businesses more effective.

- c) In Chittagong number of private organizations is increasing. Banks, financial institutions, and other organizations opening their branches in Chittagong more. Real estate developments are also solid in Chittagong. Main 3 players in this industry in Chittagong are Sanmar, Equity and Epic Builders. But new land development opportunities are also on a high.
- d) Crude oil extracts are also becoming available in Chittagong as new players are stepping into this industry. One notable organization is CVO Petrochemicals (formerly known as Chittagong Vegetable Oil Petrochemicals). CVO petrochemicals have already started its production of oil extracts and if the product comes in the market it will be able to meet the internal demands of oil.
- e) New universities are being formed in Chittagong and currently it has 8 private universities. Schools and colleges are also large in numbers. These students hangout more often in places and new hangout places are being opened. There are a number of world class restaurants that are operating in Chittagong namely; Baskin and Robbins, Rio Coffee, Pizza Hut, Broast etc.
- f) Previously only one 4 star hotel was situated in Chittagong named Hotel Agrabad. Now there are 3. Hotel Peninsula has been operating for quite some time and only this March 2015 Hotel Radisson Blu: Bay view has been opened. This creates new opportunities for business.
- g) Number of crime has been reported low from the year 2014 and within a tense political situation that is still ongoing, Chittagong is almost free from it. In 2015 a handful of big political violence that has been reported in Chittagong. Whoever did those incidents brought into hands of justice very soon and had been taken into custody. People are safer than before and it is felt as well as people say about it.
- h) New plans for development have been initiated by Chittagong Development Authority. These include International Conference Center, Nilachol residential area, IT tower, Elevated expressway, Satellite Town, Underground tunnel under Karnaphuli River and many more. These projects will bring in lots of investments in Chittagong and will create a huge number of jobs.
- i) Bangladesh hasn't been hit by the economic recession back in the year 2008. While all the neighboring countries had some effects Bangladesh maintained a steady growth of its GDP. Growth rate of Bangladesh is also positive in light of the recent years and so does the inflation rate. From the staggering rate of 10% in the year 2008 the inflation rate is now at 6.14% for February, 2015 [Source: Bangladesh Bank website] besides that government pay scale is going to be increased. It will ensure people will have more purchasing power which will be a positive indicator for economy.
- j) Government of Bangladesh has set target of 2021 as the year the country will reach the next level of development. The year is significant because that will be 50<sup>th</sup> year of independence of Bangladesh. Digital Bangladesh is one of the promises that are going on a full swing. Digital Bangladesh means digitization of every work in governmental as well as private organizations. Government has set another vision for 2041 to take Bangladesh as one of the developed nations of the world. As a nation, these initiatives set a positive goal for everyone to follow.

Although these are the current opportunities that Chittagong has in front of them, still there are some challenges, some issues that stands in the way of proper development, these are:

- a) Political unrest is the most challenging issue of the recent times. From the beginning of this year some political parties tried to halt the internal operations of the country and are doing everything possible against the will of the people. The political party in power is also trying their level best to tackle the situation and so far has done well. But the consequences are harsh as more than 100 people died in the aftermath. The political situation has to be controlled in order to develop a nation. Political parties have to understand that development of country is above any personal interest and they should all play their parts in it. As the

country has a goal in front of them now they should act accordingly to accomplish them. But as political parties stay in power for only 5 years, and everyone has their own idea of development it's hard to carry on a single development alternative.

- b) Intentions of change are essential. In today's globalized world where information technology makes everything available to everyone, everybody knows what they're doing and how. As they know everything, some wants to change, some don't. In order to change something in grand scale everyone must work accordingly in their own individual sectors. This reluctance to change and also changing mentality is a big challenge in front of development.
- c) The person who came ahead with the spirit is from the government. People possess some negative attitude towards government employees as they're bound to do what government does. Although the new commissioner is trying his level best to do things from a neutral point of view not everybody see him favorably as opposites will always fear him and will not cooperate. Gathering everyone under one umbrella with a farsighted approach is always challenging and Chittagong will face that as well. Besides, he is just one man. Society must take his side if it wants to change the way everything goes.
- d) Governmental organizations still didn't quite free from the bureaucratic approach that has been running for almost half a century. In order to ensure a proper development one stop service is quite essential which is absent in many cases in governmental organizations. Another thing is the trust issue. Governmental organizations don't always get trusted by the public because they don't do what they say. This is one of the major issues in front of the development of Private Public Partnership and government private collaborations.
- e) Private organizations in Bangladesh are also reluctant to change. There are reports that not all private organizations follow the ethical and environmental standards set by the government. Also they don't follow proper tax guidelines. As public don't watch government favorably, government also don't watch private organizations favorably. The trust issue is there as well, only in reverse. It's also one of the challenges in the way of development.
- f) Although governmental development organizations are working together, there are some anti-parties in all of them. Some don't wants to change. It was apparent during the billboard take down as many governmental party cadres came to stop the campaign. To remove the big billboards, cranes are needed. When Police went to bring on cranes, the crane operators tried to procrastinate. Some refused to remove the billboards as well. It was against all odds that under the dynamic and strong leadership of the commissioner they couldn't do anything serious, but it shows that not all the people wants change and they'll do it all to stop them. It poses a serious challenge for development.
- g) The environment is also one of the challenges. Chittagong is a port city. There are ample scopes of environmental disaster due to global warming. Besides, floods are one of the major issues recently and this is a serious problem in the rainy season.
- h) One of the most serious and final challenge is the consistency of the work. Although people are appreciating the change, it is difficult whether they will adapt it or not. Some people likes change and they do it. Bangladesh is a country of emotions. People want to get things done more emotionally than rationally. They use their judgment less often and always try to put everything on external and environmental factors. In order to develop consistency will be essential for both a person and the nation as whole.

## **5. Suggestions and Recommendations**

What's next? Where the City of Chittagong will go from here? On April Chittagong City Corporation will have an election determining a new mayor for the next 4 years. There are existing challenges that needs to be met. But in order to truly build a green city there are some things still to be done:

- (a) Green business policy should be implemented so that each and every business can follow the specific rules and regulations regarding the society and environment. It is not a national issue

but an international one. Countries around the world are doing it and Bangladesh should also do it.

- (b) Every business organizations should come together in the development of the city from each other's side. They don't necessarily need to build an association for it. Just they have to work on their own respective sectors and think for the existing environment. There are some cement factories that dumps the wastes in the Karnaphuli River and gets away with it as they are big in size and contribute significantly for the country. They must understand in order to build a green city the ecology should also be up to the standard. These people are getting aware now. But they should be more aware in order to stop the environmental pollution and truly contribute to the society at large.
- (c) Governmental organizations should also come forward from each of their side. They also don't necessarily need to work jointly. But they can work closely with each other, doing their job more efficiently and honestly. The trust issues arise because within them trust is not present. In order to build big things, small things must be taken care of. The people who run these organizations are honest enough. The current chairman of Chittagong Development Authority Mr. Abdus Salam is one of them. Current Police Commissioner Abdul Jalil Mondal is a man of his words. The ex-mayor was also an honest man. These people can really make a difference with their personality, attitude and work. So far they're working their level best and they should work more hard to attain the best for the city.
- (d) Political parties should get along with each other for a common interest for the country. It has to be understood that their ideology might be different, their styles might be different but the interest should be for the common welfare of the country and not on personal only.
- (e) Engaging mass people in development effort is essential for development. New commissioner always tries to raise the community spirit in them. It has time people return their faith too. The thing that people need to understand that government is responsible for their duties and responsibilities but they can't work alone. People need to come in front with their own individual efforts too. If every person living in the city can think this is my city and I have the responsibility to keep it clean and safe for others then change is possible. Good thing is people are doing this now. Almost everywhere in Bangladesh people are becoming conscious about their rights. Teachers, media, politicians, religious leaders all are urging people to be aware and do their jobs accordingly. Besides that a huge number of people of the population are young. They have great potential to do great things. Young generation is always the catalyst of change. They are getting together. These people, good people must get along if a positive change has to be made in the society and environment.
- (f) People of Bangladesh use their heart more than their brain. They are emotional in nature and wants change rapidly. But in order to ensure sustainable development they have to use more brainpower. They need to follow rules and work calmly. A professional minded approach is essential in this case. Its 44 years since independence now and the country has understood it's potential. Now to get to its goal people just need to work their way as it is and in no time Bangladesh can be one of the developed nations in the world.

## **6. Conclusion**

In 2000 United Nations set Millennium Development Goals (MDG) prior to the new millennia that will be expired this year. Remarkably Bangladesh was being able to meet most of its goals in according to the resolution and set exemplary achievements in front of the other developing countries. The 7<sup>th</sup> goal was environmental sustainability and Bangladesh is also doing well in this sector. The nation is working its way up. The new Sustainable Development Goals (SDG) which will be announced this year will also be one of the avenues on which Bangladesh will set its standards. The ongoing development initiative in Chittagong is one of those things that Bangladesh wants to achieve says the current police commissioner along with the help of the society and its people. It has to be kept in mind that initiative without the involvement of mass people is unattainable. Government alone can't solve all the problems and businesses alone can't run a fair development in the country. In order to do so

collaborations are also needed. For proper development each component that builds up the society has to work together. Success will come to those who want to change and works for it. People want change now and are working. To see the success in grand scale maybe it has to wait but the revolution has already begun and result is on the way. Slowly but surely a steady development is on the cards.

## **Acknowledgements**

First of all thanks to the almighty creator who has created everyone and everything. Without the authority of whom this paper wouldn't be prepared.

Then the thanks go to the Police Commissioner of Chittagong Metropolitan Police Md. Abdul Jalil Mondal. His tremendous work among the people has brought a new dimension and era in Chittagong. His contribution and assistance in preparing this report was vital. He helped researcher from time to time with information about his work and attitude in order to get a true nature of his work. His Staff Officer Mr. Asif Ahmed has also assisted with giving information about the nature of work of the Police Commissioner.

There are other people who deserve thanks namely; the chairman of Chittagong Development Authority (CDA) Md. Abdus Salam, the ex-mayor of Chittagong City Corporation Alhaj M. Manjur Alam, the owner and chairperson of Pacific Jeans Mr. Nasir Ahmed, Managing Director of M N Group Mohiuddin Ahmed Minto are among them.

Other professionals and the academicians who assisted researcher to make the report also deserve huge thanks because without their contributions the report wouldn't be made.

## **References**

- AECOM Consult, Inc., (2005), Synthesis of Public-Private Partnership Projects for Roads, Bridges and Tunnels from Around the World. 1985-2004, Washington D.C.: United States Department of Transportation.
- Bangladesh Bank Official Website (2015), Current Inflation Rate in Bangladesh, retrieved from: <http://www.bangladesh-bank.org/Economic data/Economic statistics>
- Bangladesh Observer (2014), CMP brings down Illegal Billboards, retrieved from: <http://www.observerbd.com/2014/11/17/55227.php>
- Belal, A. T. (2001), A study of corporate social disclosures in Bangladesh. Management Auditing Journal 16 (5), 274-289
- Chittagong City Corporation Official Website (2015), History, Services & Project, retrieved from: <http://www.ccc.org.bd/>
- Chittagong Development Authority Official Website (2015), CDA at a Glance, Projects, retrieved from: <http://www.portal.cda.gov.bd/>
- CTG News (2015), Commissioner went out in disguise to see the condition of the local people, retrieved from: <http://ctgnews.com/leadnews/99256.php>
- Cooney, S. (2009), "Build A Green Small Business: Profitable ways to become an ecopreneur."
- Dhaka Tribune (2014), CMP Conducts Cleanliness Campaign. Retrieved from: <http://www.dhakatribune.com/bangladesh/2014/oct/24/cmp-conducts-cleanliness-campaign-chittagong>
- Gómez-Ibáñez, J.A., Meyer, J.R., (1993), Going Private: The International Experience with Transport Privatization. Washington, D.C.: The Brookings Institution, November.
- Hassan M.R. (2012), PPP in Bangladesh: Reality and Prospect. ASA University Review, Vol. 6 No. 1, January–June
- Hoessle, U. (2013), Ten Steps toward a Sustainable Business, Walla Walla Solutions Series 1, Seattle, ISBN 978-0-9898270-0-3

Islam, A. K. M. R. (2009), Report on Prospects of PPP in Water Supply & Sanitation (WSS) Sector in Bangladesh. Report for DEVCON-BETS CONSORTIUM. December Conference

Miyan M. A. (2006), Dynamics of Corporate Social Responsibility-Bangladesh Context. Journal of AIUB Bangladesh, August, Vol.3, No. 1, 13-32

Planning Commission of Government of the People's Republic of Bangladesh (2012), Perspective Plan of Bangladesh 2010-2021. April Edition

Wikipedia (2015), Definition, Strategy of Sustainable Business, Green Business. Retrieved from: [http://en.wikipedia.org/wiki/Green\\_business](http://en.wikipedia.org/wiki/Green_business)

# **RISK, EFFICIENCY AND PERFORMANCE OF ISLAMIC BANKING: Empirical Study on Islamic Bank in Indonesia**

SUTRISNO  
Magister Manajemen Program – Economics Faculty  
Universitas Islam Indonesia  
sutrisno\_uui@yahoo.com

## ABSTRACT

*Banking is an institution that is very regulated company, both of capital, funding, and liquidity. Bank management must be able to control the risks and efficiency in order to improve its performance. The purpose of this study is to examine the effect of risk and efficiency on the performance of Islamic banking. Risk consists of the financing risk that is proxied by non performing loan (NPF), capital risk that measured by capital adequacy ratio (CAR) and liquidity risk is proxied by financing to deposit ratio (FDR) and the minimum reserve requirement (RR). The efficiency is measured by operating expenses to operating income ratio (BOPO). While Islamic banking performance measured by return on assets (ROA) and net profit margin (NPM). The samples in this study were 8 Islamic banks in Indonesia with quarterly data and processed using multiple regression analysis. The results showed that FDR, CAR, BOPO and Size are significantly affect the performance of Islamic banking. While the RR and NPF no effect significantly to the performance of Islamic banking.*

*Key word: Financing to Deposit Ratio, Non Performing Financing, Return on Asset, Net Profit Margin*

## **1. Introduction**

Banking is one of the pillars that sustain the economy of a country. Banking is very important for public to save their money and also to seek source of finance for people in need funds. Banks have a function as a financial intermediary of a society that excess funds to communities in need of funds. Similarly, the Islamic banking which in recent years began to grow rapidly, it also serves as a financial intermediary. Which distinguishes with the conventional banking is the instrument used. Conventional banks use interest instruments while Islamic banks are not permitted to use the instrument of interest.

Bank is a business that is highly regulated by the government. This is because the source of banking funds mostly come from the public. If there is a bank that failed and liquidated then the impact would be detrimental to the community moreover it could even affect the stability of the economy if the the bank failure has systemic impact . Therefore, the bank's operations are highly regulated by the government through the role of Bank Indonesia. For example, banks are required to provide cash as a minimum giro requirement (RR) at least 5% of the total liabilities immediately payable, financing granted may not exceed 110% of public funds. Financing problems should not exceed 5%, the minimum capital adequacy ratio of 8%, and other rules.

The bank's management is required to manage the risks well without breaking the bank established rules. Muhammad (2011) suggested that Islamic banking is a risky bank because in many operations related to products containing such risks of mudharaba and musharaka financing. The products were prone to dishonesty or fraud risk clients in the transaction. Bank Indonesia through circulars SE No. 5/21 / DPNP / 2003 are updated to SE No. 13/23 / DNDP in 2011 to encourage the application of risk management to credit risk, capital risk, operating risk, and other non-financial risks. Ahmed et al (2011) examined the risk of using three variables namely risk financing risk, liquidity risk and operational risk. While Muhammad (2011) divides risks into four categories namely credit risk, liquidity risk (liquidity ratio), capital risk , and operating risks.

The bank's business is trust, to maintain the trust of banks, the bank should be able to maintain liquidity which provides funding at any time if customers withdraw their funds. The bank also the bank should be able to provide funds to meet the agreed financing commitments. Liquidity is a key element (Mohammed et al, 2013) so that Bank Indonesia set a minimum threshold of liquidity referred

to statutory reserve of 5%. Liquidity of the bank should be enough, should not be too small and should not be too big. If too large it can impact on many funds of the banks which are idle which are resulting the lesser opportunities to generate the profit.

Bank Indonesia also regulates bank capital according to international regulations Bank International Settlement (BIS). Bank capital is a very important factor, because if the bank is bankrupt, it can cover the loose. In accordance with BIS, capital adequacy ratio serves to mitigate the risk of loss. The bank's capital will be used for capital (CAR) is a minimum of 8%. Haron (1996) and Srairi (2009) found a significant relationship between capital adequacy ratio and the performance of Islamic banking

The major of Islamic banks income derived from financing provided. The higher financing given the opportunity to make a profit is also higher. However, the provision of financing must be careful, because it also can lead to many problems. Financing risk is measured by the amount of financing that Non Performing Financing (NPF). The higher NPF cause lesser bank profits because banks should provide more reserves for receivables.

Bank profits earned from bank income reduced by banks' operating costs. According to Qureshi and Shaikh (2012) one way to measure the efficiency is the ratio of operating expenses and operating income (BOPO) of the bank. The higher the BOPO shows the bank's operations getting more inefficient.

Islamic banks in Indonesia which is still comparatively short, have a sharp variation in terms of total assets. Ahmed et al (2011) found a positive effect of the size of the bank and total assets of and proxy performance of Islamic banks. The larger banks are increasingly trusted by the public, both for the purposes of saving money and financing.

## **2. Theoretical Review And Hypothesis**

### **2.1. Liquidity Risk and performance of Islamic banks**

Mohammed et al (2013) revealed the bank liquidity is an important and a key element in managing the bank's assets. According to Arifin (2012) liquidity management is one of the highest priorities in the financial institution. Good Liquidity Management will be able to meet the funding requirements for both customers who will take their funds at any time and provide funds to meet financial commitments. According to Bank Indonesia Regulation No. 13/23 / PBI / 2011 on the application of risk management for Islamic banks and Islamic business units, bank liquidity is measured by the minimum reserve requirement (RR) and financing to deposit ratio (FDR). RR is intended to maintain daily liquidity, while FDR was granted financing compared with public funds. The higher reserve requirement showed the higher the security of public funds, but on the other hand with the increasing amount of the reserve requirement, the greater the number of idle funds, thus reducing the opportunity for gain. Meanwhile, the higher the FDR showed the greater amount lent, but greater liquidity risk due to the loaned funds can not be withdrawn at any time.

Mohammed et al (2013) revealed the bank liquidity is an important and a key element in managing the bank's assets. According to Arifin (2012) liquidity management is one of the highest priorities in the financial institution. Good Liquidity Management will be able to meet the funding requirements for both customers who will take their funds at any time and provide funds to meet financial commitments. According to Bank Indonesia Regulation No. 13/23 / PBI / 2011 on the application of risk management for Islamic banks and Islamic business units, bank liquidity is measured by the minimum reserve requirement (RR) and financing to deposit ratio (FDR). RR is intended to maintain daily liquidity, while FDR was granted financing compared with public funds. The higher reserve requirement showed the higher the security of public funds, but on the other hand with the increasing amount of the reserve requirement, the greater the number of idle funds, thus reducing the opportunity for gain. Meanwhile, the higher the FDR showed the greater amount lent, but greater liquidity risk due to the loaned funds can not be withdrawn at any time.

Ani et al (2012) found a significant relationship between the loan and total assets and profitability, while Srairi (2009) found no difference in liquidity between Islamic banks and conventional banks. Ruslim (2012) and Ariyani (2010) who studied in Islamic banking in Indonesia find the influence of the LDR and profitability.

*H<sub>1</sub>: Reserve Requirement (RR) negatively affect the performance of Islamic banks*

*H<sub>2</sub>: Financing to deposit ratio (FDR) has positive influence on the performance of Islamic banks*

### **2.2. Financing risk and performance of Islamic banks**



Banks including Islamic banks established the ultimate goal is for profit, and the profits can be used to pay for the results to clients penabungnya and profits for their owners. The main sources of Islamic banks profits derived from the financing provided, so that the greater the financing provided has a great opportunity to obtain greater profits. On the other hand, with the increasing amount of Financing risk also raises the potential losses due to Financing risk problems. Management of Islamic banks is expected to provide Financing risk to the principle of caution in order to control the financing risk. Financing problems in Islamic banking is often called non-performing financing (NPF). The higher NPF showed greater funding problems and the greater reserve should be provided for the elimination of receivables, which is still could potentially reduce the level of profit.

Akhtar et al (2011) which is still conducted research on Islamic banking in Pakistan found a significant effect of NPL and banking performance. Similarly and Srairi (2009) who studied Islamic banking in the Gulf countries also found a significant pengaruh. Ruslim (2012) found a significant and negative influences between the NPF and the performance of Islamic banks in Indonesia.

*H<sub>3</sub>: Non Performing Finance (NPF) negatively affects the performance of Islamic banks*

### 2.3. Capital risk and the performance of Islamic banks

For each company, capital is very important in order to develop the business. For the banking capital is also very important, because the function of capital only used reserves to cover losses, bank capital is also one measure of bank soundness. The higher capital owned by the bank showed the better health of banks. Bank capital set by Bank Indonesia with reference to international regulations 'Bank of International Settlement' which is a minimum of 8%. Measured by bank capital adequacy ratio of capital or capital adequacy ratio (CAR), which is the ratio between equity capital held by banks with risk-weighted assets. Management of the bank should be able to manage that amount sufficient capital means not too small but not too big. If the CAR of banks too big, in terms of the bank's good health but with too magnitude CAR showed a lot of funds are unemployed because many funds are stored in the capital. Therefore, the greater the CAR will reduce opportunities for gains.

Akhtar et al (2011) found a significant negative effect between the CAR and the performance of Islamic banks. Srairi (2009) also found the same thing that CAR negatively affects the profitability of Islamic banks. However, Idris et al (2011) found insignificant effect of CAR and the performance of Islamic banks in Malaysia. Similarly and Ruslim (2012) found no significant effect of CAR and the performance of Islamic banks in Indonesia.

*H<sub>4</sub>: Capital Adequacy Ratio (CAR) negatively affects the performance of Islamic banks*

### 2.4. Efficiency and performance of Islamic banks

The size of the operational efficiency of Islamic banking can use the ratio of operating expenses to operating income (Mohammed, 2011). Corporate profits derived from revenue minus costs, so if the cost can be reduced expected to increase profits. BOPO with a large rate show that Islamic banking is less efficient in beroperasi, thereby decreasing the rate of profit. Ariyani (2010) find a negative pengaruh significantly between BOPO and profitability.

*H<sub>5</sub>: The ratio of operating expenses to operating income (BOPO) negatively affects the performance of Islamic banks*

### 2.5. The size of the company and the performance of Islamic banks

Company size indicated by the number of assets also affect banks in profit. The greater the greater the ability of banks to provide Financing risk, because they have more funds to provide Financing risk. Akhtar et al (2011) use firm size as control variables which is still affect profitability. Zeitun (2012), Idris et. al (2011) and Srairi (2009) using size as a variable affecting profitability. The next hypothesis is:

*H<sub>6</sub>: Firm size (SIZE) has positive influence on the performance of Islamic banks*

## 3. Research Framework

After discussing the background of the problem, theoretical studies and the development of hypotheses, the research concept can be described as follows:

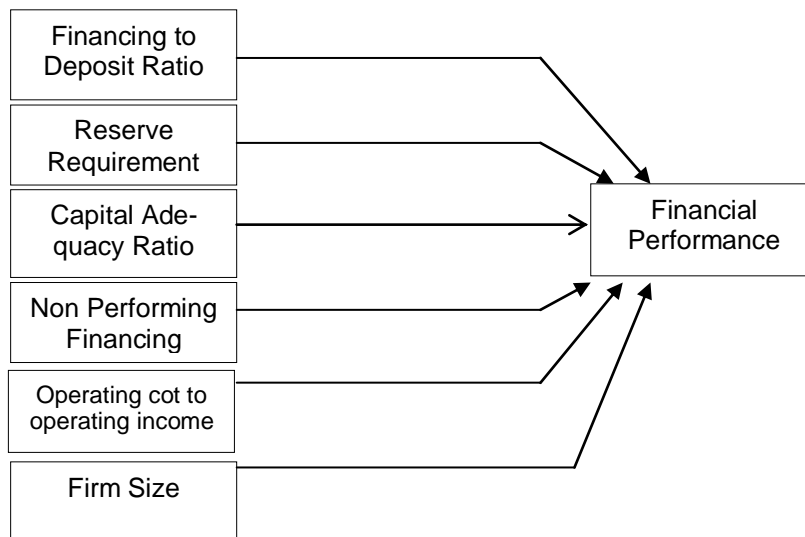


Figure 1  
Research Framework

## 4. Research Method

### 4.1. Population and Sample

The population in this research are all Islamic banks operating in Indonesia, which currently is 11 Islamic banks. From the 11 Islamic banks there are some new banks, so it is not included in the study, so this research will take a sample of eight Islamic banks which is established earlier. The data taken is in the form of data quarterly. Here is a list of banks which is still will be studied:

Table 1: List of Samples

No	Banks Name
1	PT. Bank Muamalat Indonesia
2	PT. Bank Syariah Mandiri
3	PT. Bank Mega Syariah
4	PT. Bank BRI Syariah
5	PT. Bank Bukopin Syariah
6	PT. Bank Panin Syariah
7	PT. Bank BCA Syariah
8	PT. Bank BNI Syariah

Source: Sharia bank statistic, September 2012 (Bank Indonesia)

### 4.2. Research Variables

In accordance to the conceptual framework of research in the future, then in this study, there are two dependent variables, five independent varabel and one control variable, and variable measurements as follows:

Table 2: Measurement of Variables

No	Variable	Notation	Measurement
1	Return on Assets	ROA	Income/Assets Average
2	Net Profit Margin	NPM	EAT/Operational Income
3	Financing to Deposit Ratio	FDR	Total Pembiayaan/Dana Masyarakat
4	Reserve Requirement	RR	Cash + BI Saldo/Obligation soon to be paid

5	Capital Adequacy Ratio	CAR	Owned Capital/Activa Measured according to total risk
6	Non Performing Financing	NPF	Financing Problems / Total Financing
7	Operating Cost to Operating Income	BOPO	Operational Cost/Operational Income
8	Firm Size	SIZE	Loan Total Assets

#### 4.3. Data Analysis

In order to explain the influence of the independent variables on the dependent variable, will be used multiple regression statistical analysis. Multiple regressions is a regression technique which is still describes the influence of the dependent variable with the independent variable. The multiple regression equation is as follows:

$$ROA = \beta_0 + \beta_1 FDR + \beta_2 NPF + \beta_3 CAR + \beta_4 BOPO + \beta_5 RR + \beta_6 SIZE \quad (1)$$

$$NPM = \beta_0 + \beta_1 FDR + \beta_2 NPF + \beta_3 CAR + \beta_4 BOPO + \beta_5 RR + \beta_6 SIZE \quad (2)$$

Which:

ROA = Return On Assets

NPM = Net Profit Margin

FDR = Financing to Deposit Ratio

NPF = Non Performing Financing

CAR = Capital Adequacy Ratio

BOPO = Rasio Biaya Operasi terhadap Pebdapatan Operasi

RR = Reserve requirement

SIZE = Fiem size

## 5. Result and Discussion

### 5.1. Descriptive statistic

From the results of the data with the help of the program E-views obtained descriptive statistics as follows:

Table 3: Descriptive Statistic

	Mean	Median	Maximum	Minimum	Std. Dev.
ROA	1.28	1.53	4.25	-12.02	1.7832
NPM	7.41	7.15	16.14	-8.72	4.0977
BOPO	88.17	86.57	183.34	50.79	20.5589
FDR	97.6	91.87	205.31	35.43	20.325
CAR	21.78	13.93	91.23	9.04	16.652
RR	6.33	5.25	26.55	5.02	16.652
NPF	3.32	2.96	8.46	0	6.4132
SIZE	15.61	15.67	17.88	11.99	1.3141

Source: Data processed

Islamic banking performance which is measured by return on assets (ROA) shows the average is relatively low but positive by 1.28%. Highest ROA of 4.25% achieved by Bank Mega Syariah at the beginning of its establishment in 2010, while the lowest ROA of -12.02% was obtained by BNI Syariah at the beginning of the bank's operations in 2010. Judging from the net profit margin (NPM) showed an average of 7.41% with a maximum of 16:14 NPM% acquired by Bank Mega Syariah in the second quarter of 2011. While the lowest NPM by -8.72% experienced by Panin Bank Syariah the beginning of the operation of the first quarter of 2010.

The level of bank efficiency Islamic banking performance which is measured by return on assets (ROA) shows the average is relatively low but positive by 1.28%. Highest ROA of 4.25% achieved by Bank Mega Syariah at the beginning of its establishment in 2010, while the lowest ROA

of -12.02% was obtained by BNI Syariah at the beginning of the bank's operations in 2010. Judging from the net profit margin (NPM) showed an average of 7.41% with a maximum of 16:14 NPM% acquired by Bank Mega Syariah in the second quarter of 2011. While the lowest NPM by -8.72% experienced by Panin Bank Syariah the beginning of the operation of the first quarter of 2010.

The level of bank efficiency Islamic banking performance which is measured by return on assets (ROA) shows the average is relatively low but positive by 1.28%. Highest ROA of 4.25% achieved by Bank Mega Syariah at the beginning of its establishment in 2010, while the lowest ROA of -12.02% was obtained by BNI Syariah at the beginning of the bank's operations in 2010. Judging from the net profit margin (NPM) showed an average of 7.41% with a maximum of 16:14 NPM% acquired by Bank Mega Syariah in the second quarter of 2011. While the lowest NPM by -8.72% experienced by Panin Bank Syariah the beginning of the operation of the first quarter of 2010.

The level of bank efficiency as measured by operating costs compared with operating income (ROA) showed an average of 88.17%. BOPO high of 183.34% was obtained by Panin Bank Syariah at the beginning of the operation of the 2nd half of 2010, while the lowest was 50.79% ROA on Panin Bank Syariah the end of 2012.

CAR capital ratio shows the average number of 21.79% higher with the highest CAR of 91.23% of BCA Syariah at the beginning of the operation. CAR for it demonstrates the ability of banks to disburse very low, so many unemployed equity. While CAR low of 9.04 produced by the Bank Syariah Bukopin in 2009.

The ratio of a bank's ability to channel financing compared with public funds as measured by the financing to deposit ratio (FDR) by an average of 97.60%. FDR high of 205.31% obtained by Panin Bank Syariah the middle of 2011, while the lowest was 35.43% FDR of Panin Bank Syariah in 2009 when the initial operation of the bank. Liquidity in the form of the provision of the minimum reserve requirement (RR) averaging 6.33% with a value of 26.55% and a centipede minimum of 5:02%

Financing risk Islamic banking performance which is measured by return on assets (ROA) shows the average is relatively low but positive by 1.28%. Highest ROA of 4.25% achieved by Bank Mega Syariah at the beginning of its establishment in 2010, while the lowest ROA of -12.02% was obtained by BNI Syariah at the beginning of the bank's operations in 2010. Judging from the net profit margin (NPM) showed an average of 7.41% with a maximum of 16:14 NPM% acquired by Bank Mega Syariah in the second quarter of 2011. While the lowest NPM by -8.72% experienced by Panin Bank Syariah the beginning of the operation of the first quarter of 2010.

The level of bank efficiency as measured by operating costs compared with operating income (ROA) showed an average of 88.17%. BOPO high of 183.34% was obtained by Panin Bank Syariah at the beginning of the operation of the 2nd half of 2010, while the lowest was 50.79% ROA on Panin Bank Syariah the end of 2012.

CAR capital ratio shows the average number of 21.79% higher with the highest CAR of 91.23% of BCA Syariah at the beginning of the operation. CAR for it demonstrates the ability of banks to disburse very low, so many unemployed equity. While CAR low of 9.04 produced by the Bank Syariah Bukopin in 2009.

The ratio of a bank's ability to channel financing compared with public funds as measured by the financing to deposit ratio (FDR) by an average of 97.60%. FDR high of 205.31% obtained by Panin Bank Syariah the middle of 2011, while the lowest was 35.43% FDR of Panin Bank Syariah in 2009 when the initial operation of the bank. Liquidity in the form of the provision of the minimum reserve requirement (RR) averaging 6.33% with a value of 26.55% and a centipede minimum of 5:02%

Financing risk Islamic banking performance which is measured by return on assets (ROA) shows the average is relatively low but positive by 1.28%. Highest ROA of 4.25% achieved by Bank Mega Syariah at the beginning of its establishment in 2010, while the lowest ROA of -12.02% was obtained by BNI Syariah at the beginning of the bank's operations in 2010. Judging from the net profit margin (NPM) showed an average of 7.41% with a maximum of 16:14 NPM% acquired by Bank Mega Syariah in the second quarter of 2011. While the lowest NPM by -8.72% experienced by Panin Bank Syariah the beginning of the operation of the first quarter of 2010.

The level of bank efficiency as measured by operating costs compared with operating income (ROA) showed an average of 88.17%. BOPO high of 183.34% was obtained by Panin Bank Syariah at the beginning of the operation of the 2nd half of 2010, while the lowest was 50.79% ROA on Panin Bank Syariah the end of 2012.

CAR capital ratio shows the average number of 21.79% higher with the highest CAR of 91.23% of BCA Syariah at the beginning of the operation. CAR for it demonstrates the ability of banks

to disburse very low, so many unemployed equity. While CAR low of 9.04 produced by the Bank Syariah Bukopin in 2009.

The ratio of a bank's ability to channel financing compared with public funds as measured by the financing to deposit ratio (FDR) by an average of 97.60%. FDR high of 205.31% obtained by Panin Bank Syariah the middle of 2011, while the lowest was 35.43% FDR of Panin Bank Syariah in 2009 when the initial operation of the bank. Liquidity in the form of the provision of the minimum reserve requirement (RR) averaging 6.33% with a value of 26.55% and a centipede minimum of 5:02%

Financing risk Islamic banking performance which is measured by return on assets (ROA) shows the average is relatively low but positive by 1.28%. Highest ROA of 4.25% achieved by Bank Mega Syariah at the beginning of its establishment in 2010, while the lowest ROA of -12.02% was obtained by BNI Syariah at the beginning of the bank's operations in 2010. Judging from the net profit margin (NPM) showed an average of 7.41% with a maximum of 16:14 NPM% acquired by Bank Mega Syariah in the second quarter of 2011. While the lowest NPM by -8.72% experienced by Panin Bank Syariah the beginning of the operation of the first quarter of 2010.

The level of bank efficiency as measured by operating costs compared with operating income (ROA) showed an average of 88.17%. BOPO high of 183.34% was obtained by Panin Bank Syariah at the beginning of the operation of the 2nd half of 2010, while the lowest was 50.79% ROA on Panin Bank Syariah the end of 2012.

CAR capital ratio shows the average number of 21.79% higher with the highest CAR of 91.23% of BCA Syariah at the beginning of the operation. CAR for it demonstrates the ability of banks to disburse very low, so many unemployed equity. While CAR low of 9.04 produced by the Bank Syariah Bukopin in 2009.

The ratio of a bank's ability to channel financing compared with public funds as measured by the financing to deposit ratio (FDR) by an average of 97.60%. FDR high of 205.31% obtained by Panin Bank Syariah the middle of 2011, while the lowest was 35.43% FDR of Panin Bank Syariah in 2009 when the initial operation of the bank. Liquidity in the form of the provision of the minimum reserve requirement (RR) averaging 6.33% with a value of 26.55% and a centipede minimum of 5:02%

Financing risk which is measured by the NPF shows the average number of relatively small, amounting to 3:32%, with a minimum of 0.00% and a maximum of 8:46% experienced BNI Syariah in the 1st half of 2012. This shows the problematic financing (NPF) on Islamic banking is still controlled because the maximum limit of 5%. measured by the NPF shows the average number of relatively small, amounting to 3:32%, with a minimum of 0.00% and a maximum of 8:46% experienced BNI Syariah in the 1st half of 2012. This shows the problematic financing (NPF) on Islamic banking is still controlled because the maximum limit of 5%. measured by the NPF shows the average number of relatively small, amounting to 3:32%, with a minimum of 0.00% and a maximum of 8:46% experienced BNI Syariah in the 1st half of 2012. This shows the problematic financing (NPF) on Islamic banking is still controlled because the maximum limit of 5%. NPF measured shows the average number of relatively small, amounting to 3:32%, with a minimum of 0.00% and a maximum of 8:46% experienced BNI Syariah in the 1st half of 2012. This shows the problematic financing (NPF) on Islamic banking is still controlled because the maximum limit of 5%. measured by operating costs compared with operating income (ROA) showed an average of 88.17%. BOPO high of 183.34% was obtained by Panin Bank Syariah at the beginning of the operation of the 2nd half of 2010, while the lowest was 50.79% ROA on Panin Bank Syariah the end of 2012.

CAR capital ratio shows the average number of 21.79% higher with the highest CAR of 91.23% of BCA Syariah at the beginning of the operation. CAR for it demonstrates the ability of banks to disburse very low, so many unemployed equity. While CAR low of 9.04 produced by the Bank Syariah Bukopin in 2009.

The ratio of a bank's ability to channel financing compared with public funds as measured by the financing to deposit ratio (FDR) by an average of 97.60%. FDR high of 205.31% obtained by Panin Bank Syariah the middle of 2011, while the lowest was 35.43% FDR of Panin Bank Syariah in 2009 when the initial operation of the bank. Liquidity in the form of the provision of the minimum reserve requirement (RR) averaging 6.33% with a value of 26.55% and a centipede minimum of 5:02%

Financing risk as measured by the NPF shows the average number of relatively small, amounting to 3:32%, with a minimum of 0.00% and a maximum of 8:46% experienced BNI Syariah in the 1st half of 2012. This shows the problematic financing (NPF) on Islamic banking is still controlled because the maximum limit of 5%. measured by operating costs compared with operating income (ROA) showed an average of 88.17%. BOPO high of 183.34% was obtained by Panin Bank Syariah

at the beginning of the operation of the 2nd half of 2010, while the lowest was 50.79% ROA on Panin Bank Syariah the end of 2012.

CAR capital ratio shows the average number of 21.79% higher with the highest CAR of 91.23% of BCA Syariah at the beginning of the operation. CAR for it demonstrates the ability of banks to disburse very low, so many unemployed equity. While CAR low of 9.04 produced by the Bank Syariah Bukopin in 2009.

The ratio of a bank's ability to channel financing compared with public funds as measured by the financing to deposit ratio (FDR) by an average of 97.60%. FDR high of 205.31% obtained by Panin Bank Syariah the middle of 2011, while the lowest was 35.43% FDR of Panin Bank Syariah in 2009 when the initial operation of the bank. Liquidity in the form of the provision of the minimum reserve requirement (RR) averaging 6.33% with a value of 26.55% and a centipede minimum of 5:02%

Financing risk as measured by the NPF shows the average number of relatively small, amounting to 3:32%, with a minimum of 0.00% and a maximum of 8:46% experienced BNI Syariah in the 1st half of 2012. This shows the problematic financing (NPF) on Islamic banking is still controlled because the maximum limit of 5%.

## 5.2. Hypothesis Test Results and Discussion

The results of hypothesis testing with the dependent variable consists of return on assets (ROA) and net profit margin (NPM) as follows:

Table 4: Hypothesis Test Results

Variables	ROA		NPM	
	t-statistic	Prob	t-statistic	prob
FDR	1.180215	0.024	3.115036	0.0023
RR	0.595167	0.5527	-3.697186	0.0003
NPF	-0.451899	0.6521	-0.591225	0.5554
CAR	-1.063765	0.0294	-2.766312	0.0065
BOPO	-6.431144	0.0000	-7.777839	0.0000
SIZE	0.238665	0.0117	4.640731	0.0000

### 5.2.1. Liquidity Risk

Liquidity is the ability of banks to meet withdrawals at any time and meet the financing commitments (Siamat, 2005). Likuidits measured by two variables financing to deposit ratio (FDR) and the minimum reserve requirement (RR). From the results of hypothesis testing with ROA as the dependent variable with FDR as independent variables, the t-statistic values obtained positive with proabilitas singnifikansi of 0.0240. It shows that the FDR is significantly and positively with ROA as the significance value is smaller than the significance level disyaratkan 0:05. Similarly, when the NPM as the dependent variable, the t-statistic figures obtained positive with 0.0023 significance level less than the level of significance required. It can thus be concluded that the hypothesis is proven, meaning that the higher financing given the higher keuntuangan given. Heightened FDR showed that given the higher financing, thus providing an opportunity to obtain greater profits. While the results of hypothesis liquidity as measured by the reserve requirement on ROA, it turns out the effect is not significant because of greater significance level 0.5527 0:05. This suggests that the size of the reserve has no effect on ROA. While the influence of the NPM, RR has a negative and significant effect characterized by the probability value of 0.0003 is smaller than the required level of significance. Indicates the greater the magnitude of reserve funds for liquidity reserves, so the greater the more reserve funds which resulted in increasingly smaller idle funds for financing, thereby reducing the performance of the bank. Bukhari and Qudus (2012) also found a significant relationship between the financing to profitability. Ariyani (2010) also find a positive effect LDR with ROA that supported by Ruslim (2012).

### 5.2.2. Financing Risk

Financing risk is the amount of financing problems faced by Islamic banks are measured with no performing financing (NPF). Hypothesis test results showed the NPF has a value of t-statistic significant negative and not good with the dependent variable ROA mapun NPM. Significance value of 0.6521 to 0.5554 against the NPM ROA and higher than the required level of significance. Thus the financing risk as measured by the NPF has no effect on the performance of Islamic banks. This is likely due to the NPF Islamic banks are relatively small, as indicated by the average of the NPF at 3:32%, the highest and the lowest 8.46% 0.00%. Indicating a high NPF financing risk management is good enough. Ariyanti and Muharram (2012) supports these results. However Akhtar et al (2011) and Idris et al (2011) found a significant relationship between the NPF with the performance of Islamic banks. Likewise with Rahman and Rochmanika (2012) also found a significant effect.

#### 5.2.3. Capital Risk

The results of hypothesis test bank capital adequacy as measured by CAR showed a negative influence and exhibited significantly better performance as measured by ROA and NPM, which is still indicated by a negative value of t-statistics and with significance value for ROA of 0.0294 and 0.0065 for the NPM is smaller than the level 0:05 significance. These results are consistent with the hypothesis proposed and could mean that the higher the CAR will further degrade the performance of Islamic banks. CAR high, then the funds much absorbed into the capital, thus reducing the chance to be played in the financing, resulting in decreased profitability.

These results are consistent with the findings of Akhtar et al (2011), Srairi (2009), Ani et al (2012). Similarly, the findings Ariyani (2010) and Ruslim (2012) who found a significant effect of CAR with the performance of Islamic banks in Indonesia.

#### 5.2.4. Efficiency

Bank efficiency is measured by the ratio of operating expenses with operating income (BOPO). From the results of hypothesis testing, t-values obtained on ROA and BOPO Statistically significant negative NPM, because the significance value is smaller than which is still required by 0:05. This result can be said that the level of efficiency as measured by BOPO has a significant and negative effect, meaning that the higher the BOPO resulted in decreased performance of Islamic banks. The high BOPO indicates banks are increasingly inefficient in managing their assets so as to lower the rate of profit.

Syafri (2012), srairi (2009) and Akhtar et al (2011) also found a significant relationship between BOPO with profitability. Similarly with Ariyani (2010) and Ruslim (2012) who study Islamic banks in Indonesia also found a significant effect.

#### 5.2.5. Company Size

Banks which have a large assets are more likely to obtain the number of larger customers, because the people have more confidence both in store and Untuk obtain Financing risk funds. The results show the effect of firm size hypothesis (size) with the performance of the bank (ROA and NPM) has a value of t-statistic significant positive and marked with significance value of 0.0117 on ROA and 0000 to NPM. Thus the size of the company has a significant and positive effect on the performance of Islamic banks.

These results issimilar with the findings of Idris et al (2011) which is still conducted research on that Islamic banking in Malaysia. Syafri (2012), and Ahmed et al (2011) also found a positive effect between firm size and performance. While Ani et al (2012) and Akhtar et al (2011) found no significant relationship between firm size and performance..

## 6. Closing

From the analysis and discussion, it can be concluded that the liquidity risk of the which is measured by the financing to deposit ratio (FDR) has a significant positive effect, so expect the management to manage FDR well without ignoring the risk of financing (NPF). Whereas when measured with the minimum reserve requirement (RR) has a significant negative effect on the performance of Islamic banking. Therefore, management of Islamic banks should be able to manage the reserve as well, meaning not too high so as not a lot of idle funds.

Risk financing (NPF) has no significant impact on financial performance. While risk capital (CAR) significant and negative effect on the performance of Islamic banks, so that management needs to manage the CAR that is not too high. ROA also has a significant negative effect means higher ROA indicates inefficient banks thus reducing the bank's performance. While the positive effect of firm size and exhibited significantly terdapat performance of Islamic banks.

## 7. References

- Ahmed, Naveed., Muhammad Farhan Akhtar and Muhammad Usman, 2011, Risk Management Practices and Islamic Banks: An Empirical Investigation from Pakistan, *Interdisciplinary Journal of Research in Business*, Vol. 1(6), 50-57
- Akhtar, Muhammad Farhan., Khizer Ali, and Shama Sadaqat., (2011), Factors Influencing the Profitability of Islamic Bank of Pakistan, *International Research Journal of Finance and Economics*, 66, 125-132
- Ani, W.U., Ugwunta D.O, Ezendu I.J, dan Ugwuanyi G.O., (2012), An Empirical Assessment of the Determinant on Bank Profitability in Nigeria: Bank Characteristics Panel Evidence, *Journal of Accounting and Taxation*, 4(3), 38-43.
- Arianti N. P, Wuri and Harjum Muharam, (2012), Analisis Pengaruh Dana Pihak Ketiga (DPK), Capital Adequacy Ratio (CAR), Non Performance Financing (NPF), dan Return on Asset (ROA) terhadap Pembiayaan pada Perbankan Syariah, *Working Paper*, eprint.undip.ac.id/32445/jurnal\_wuri
- Ariffin, Noraini Mohd., 2012, Liquidity Risk Management And Financial Performance In Malaysia: Empirical Evidence From Islamic Banks, *Aceh International Journal of Social Sciences*, 1 (2): 68-75
- Ariyani, Desi, 2010, Analisis Pengaruh Car, NPL, Bopo dan LDR Terhadap Roa Pada Bank Devisa di Indonesia Tahun 2003-2006, *Skripsi*, Fakultas Ekonomi Universitas Diponegoro, Semarang
- Bank Indonesia, 2011, Surat Edaran SE No.13/23/DPNP tahun 2011 tentang Perubahan SE No. 5/21/DNDP/ 2003 perihal Penerapan Manajemen Risiko bagi Bank Umum
- , 2011, Peraturan Bank Indonesia Nomor 13/23/PBI/2011 Tentang Penerapan Manajemen Risiko Bagi Bank Umum Syariah Dan Unit Usaha Syariah
- Bukhari, Syeda Anum Javed., and Rana Abdul Qudous, (2012), Internal and External Determinant of Profitability of Banks: Evidence from Pakistan, *Interdisciplinary Journal of Contemporary Research in Business*, 3(9), 1037-1058
- Haron, Sudin, (1996), The Effect of Management Policy on The Performance of Islamic Banks, *Asia Pacific Journal of Management*, 13(2), 63-76
- Idris, Asma' Rashidah., Fadli Fizari Abu Hassan Asari, Noor Asilah Abdullah Taufik, Nor Jana Salim, Rajmi Mustafa and Kamaruzaman Jusoff., (2011), Determinant of Islamic Banking Institutions' Profitability in Malaysia, *World Applied Journal*, 12 (special issue).
- Mohammad, Ahmad Azam Sulaiman., Mohammad Taqiuddin Mohamad, and Muham-mad Lukman Samsudin, 2013, How Islamic Banksof Malaysia Managing Liquidity? An Emphasis on Confronting Economic Cycles, *International Journal of Business and Social Science*, Vol. 4 (7), 253-263
- Muhammad, (2011), Manajemen Bank Syariah, UPP AMP YKPN, Yogyakarta
- Qureshi, Muhammad Azeem dan Madeeha Shaikh, 2012, Efficiency of Islamic and Conventional Banks in Pakistan: A Non-parametric Approach, *International Journal of Business and Management*, Vol. 7(7)
- Rahman, Aulia Fuad and Ridha Rochmanika., (2012), Pengaruh Pembiayaan Jual Beli, Pembiayaan Bagi Hasil, dan Ratio Non Performance Financing terhadap Profitabilitas Bank Umum Syariah di Indonesia, *ejournal.uin-malang.ac.id/index.php/.../1768/pdf*
- Ruslim, 2012, Analisis Pengaruh *Capital Adequacy Ratio* (CAR), *Non Performing Loan* (NPL), Dan *Loan To Deposit Ratio* (LDR) Terhadap *Return On Asset* (ROA) pada Bank Umum Syariah Yang Terdaftar di Bank Indonesia, *Skripsi*, Fakultas Ekonomi Dan Bisnis Universitas Hasanuddin, Makassar
- Siamat, Dahlan., (2005), *Manajemen Lembaga Keuangan: Kebijakan Moneter dan Perbankan*, Lembaga Penerbit Fakultas Ekonomi Universitas Indonesia, Jakarta
- Srairi, Samir Abderrazek., Faccotrs Influencing the Profitability of Conventional and Islamic Banks in GCC Countries, *Review of Islamic Economics*, 11(1), 5-30
- Syafri, (2012), Factors Affecting Bank Profitability in Indonesia, *Paper: The 2012 International Conference on Business and Management*, Thailand



Zeitun, Rami., (2012), Determinant of Islamic and Conventional Banks Performance in GCC Countries Using Panel data Analysis, *Global Economy and Finance Journal*, 5(1), 53-72

# The Impact of Stress Source on The Worker's Work Spirit On Employee of BPR Mustakim Bank Banda Aceh

<sup>1</sup>Hamdi Harmen, <sup>2</sup>Iqbal Muhammad

<sup>1</sup>Management Department, Economics Faculty of Syiah Kuala University  
Darussalam, Banda Aceh  
Indonesia  
Email: hamdi\_harmen89@yahoo.com

<sup>1</sup>Ph.D. Student of Economics and Business Faculty  
Padjadjaran University  
Bandung, Indonesia  
Email: hamdi13002@student.unpad.ac.id

<sup>2</sup>Master Student of Economics Faculty  
Chung Hua University  
Hsin-Chu, Taiwan  
Email: tunjonge25@gmail.com

## Abstract

The purpose of this study was to examine the effect of sources of stress variables from environmental, individual, and organizational factors on employee morale. A sample of 40 respondents including all employees and the management participated in this study, and a multiple linear regression method was administered. The results indicated that stress variables from environmental, individual, and organizational factors simultaneously significant affect and closely related to the morale variables. The findings add new knowledge that may inform the organization on how to deal with stress sources and level of stress of their employees.

**Keywords:** *Employee achievement, Morale, Sources of stress.*

## 1. Introduction

The era of progress in all fields, has made the Human Resources as one asset that his role is very important, especially for the service organization. Inside the organization, the human is an active corporate planner, perpetrators and determine the realization of organizational goals.

Given the importance of human resources at the top, human resources need attention within an organization. It is known that an organization will only be effective if the organization's goals can be achieved in ways that better and more efficient. Thus the effectiveness of an organization is a requirement to achieve organizational goals and one way to find out the effectiveness of the organization referred to, can be seen from the productivity of work.

Increase or decrease in employee morale within an organization is strongly influenced by various factors, both internal factors and external factors, both at the employee's own self as well as factors arising in the respective organization. Hence the emergence of morale in the employees differ between employees with one another, the differences were not only among employees who have a different job or position, but also among employees working in the field/the same part.

Stress is one of the factors that affect employee morale with the consequences can be positive or negative role certainly will reduce the productivity of the company to achieve maximum revenue through individual work performance, stress arising from various causes which may arise from the length and intensity, and the company is highly dependent on how long the cause of progress, how much strength, and how much the employee the ability to face it.

Stress happens to the employees often result in decreased performance of the employee or in other words, performance that is incompatible with the desired expectations as to the existence of transportation interruption or delay distribution of basic commodities, this would make the employee's performance will decline seen in the level of attendance, assessment time in completing tasks or time

periods that must be completed, responsibility and understanding of the tasks assigned and so forth. So choose a new polemic in the employees, because each individual has contributed to the success of the company.

The one factor that should not be ignored in improving employee morale is states that is often experienced by every employee in the normal or behave less unstable or with other terms is stressed. This situation can lower employee morale in the work.

State of stress experienced by each employee will affect employee morale declines, which in this case the employees perform their work less seriously because of the declining morale means a profound pleasure to work do not arise in the hearts of employees. This situation can all be characterized by high levels of absenteeism that occurred, less discipline in their work, irritability/emotional, no their ability to get the job done properly and correctly and others.

Stress is a condition affecting the emotional tension, the mind and physical condition. On the other hand stress is also not necessarily being bad, although stress is usually discussed in a negative context, stress also has a positive value. Stress is an opportunity when the stress it offers a potential acquisition. More commonly, stress is associated with the constraints and demands which are first to prevent someone to do what is desired and the second refers to the loss of something very desirable. Thus, all the people in carrying out this life never escape from the stress phenomenon. Where the cause of stress is influenced by many factors such as environmental factors, organizational, and individual factors are also psychological factors.

BPR Mustakim Bank is one of the financial institutions that are professional enough in the country, certainly in terms of improving work performance should be given special attention, with a capital asset and that is strong enough. Jewel is currently working to improve knowledge and skills of employees in order to prepare the intellectual capital or human capital through management training. Training will be undertaken aimed to prepare the human resources that have solid intellectual capabilities in the banking business. They can be a powerful banker, coupled with a firm mental and spiritual.

The problem that occurs in BPR Mustakim Bank today as long turnover with new employees and turnover of positions within a short time frame, this will cause each employee unable to perform optimally. As a result of frequent change of position, causing employee stress and declining morale. These factors become very important and must be considered by the leadership so that employees actually perform.

Other phenomena that occur on the employees of BPR Mustakim Bank, among others, there are many employees who lack discipline in work, sensitive and emotional and less able to complete the job properly, quickly and correctly. It is estimated that a party of employees behave that way was caused by stress.

The problem in this research is how much influence the source of stress on employee morale BPR Mustakim Bank.

As for the objectives in this research is to investigate the influence of sources of stress on employee morale BPR Mustakim Bank.

- a. As scientific input, thought and consideration for BPR Mustakim Bank in taking policy decisions and future organizational development.
- b. It is expected that this research can be useful and become one of the guidelines for subsequent research

## **2. Review of Literature**

As a theoretical foundation and respect will be discussed it some problems as proposed on the background of the problem, it would need some authors propose in advance the understanding of stress itself.

According to the Ministry of Health (2006) states that stress is a condition manifested by a syndrome that consists of all the changes caused by nonspecific in a biological system. Thus, stress has its own characteristic form and composition, but does not have a specific reason. The elements of shape are the change that can be seen which is caused by stress, whatever the reason.

Sonda (2005) defines that stress is a "condition of tension which affects the emotions, mind and physical condition." While the book Management of Organizational Behavior in AJB Bumiputera 1912 (2002), says that stress is "a consequence or a response to the actions of a person, situation or push the lead to prosecutions or physical burden, psychological or both to someone".

According to Robbins (2008), stress is "a dynamic condition in which an individual is confronted with an opportunity, constraint (constraints) or demands (demands) are associated with what is desirable and the results are perceived as uncertain and important".

Robbins also explained that the stress does not by itself be bad, although stress is usually discussed in a negative context; stress also has a positive value. Stress is an opportunity when the stress it offers a potential acquisition. More commonly, stress is associated with the constraints and demands which are first to prevent someone to do what is desired and the second refers to the loss of something very desirable.

The uncertainty about the results or outputs and outcomes must be important. No matter the circumstances, only when there is doubt or uncertainty about whether that opportunity will be achieved, obstacles will be removed, or loss will be avoided then there is stress. That is, the highest stress for individuals who are not sure whether they lose or win, and lowest for individuals who think that winning or losing is a certainty. If you win or lose is an outcome that is not important it can be said there is no stress.

Hawari (2001), stress is defined as response / body's reaction to the various demands or burden on it that causes a change in one's life. When demand exceeds the ability of a person, then the condition is called stress.

According to Lazarus (1966) and Seyle (1980), cited Calhoun (2002) said that stress as feeling threatened, accompanied by efforts aimed at reducing the threat.

Sonda (2000) reveals that stress is defined as:

"A series of conditions in which a person is, but cannot provide proper and adequate response to environmental stimuli that it faces, or even if he can respond, he will pay a heavy price, for example in the form of chronic fatigue, tension, anxiety, pain, hopelessness, loss of self-esteem and other negative conditions of the like ".

According to Gibson (2006), this defines stress in four different definitions, namely:

- Definition of stimuli that mention or stress is the force that drives the individual stimulus resulting in a response to tension, where tension is in the physical sense, changing its form.
- The definition of the concluding stress response is a response to someone psychological or psychological pressure on the environment (stressors), where the pressure is external event or situation that is potentially disruptive.
- Response-Stimulus definition states that stress is the result of a good interaction between stimulus conditions in the environment and the tendency of individuals to respond in a certain way.
- Definition of states of stress as an adaptive response, mediated by individual differences and / or psychological process that is a consequence of any activity (environment), external circumstances or events that burden of psychological or physical demands excessive for someone.

Judging from the sources of stress, stress appearance could be caused by a variety of working conditions in which these conditions is called stressor. According to Davis & Newstrom (2001), almost every condition of employment can cause stress. But there are a number of working conditions that often cause stress for employees. These conditions are: excessive workload, pressure of time pressure, poor quality of the supervisor, the political climate of insecurity, inadequate authority to carry out responsibilities, conflict and compulsion role, the difference between the value of the company and employees, changes in type, frustrating.

The difference between the company and employees is also a condition that can cause stress, meaning that the differences that arise can affect employees with mental distress at some time attempts were made to meet the needs of companies and employees. Achievement-oriented employees can also cause stress impetus by setting their own values and goals beyond what they could do the job.

Cause next is change the type or change a job that is widely known as a common cause of stress, because it requires an adjustment of the employee. The changes tend to cause greater stress when changes are important and not uncommon.

As a result of the causes of stress is frustration, which is result of motivation (drive) that hampered that prevents someone from reaching their desired goals. This situation can cause emotional disturbances that interfere with a person's ability to function effectively, which in turn cause stress on a person.

Robbins (2008) identifies potential sources of stress into three categories, namely;

- Environmental Factors  
Environmental uncertainty will affect the design of organizational structure and also influence the level of stress on employees within the organization.  
Economic uncertainties may include uncertainties of economic, technological and organizational. Economic Uncertainty can be a change in the business cycle and also the

state of recession which will increase stress levels which would give effect to the organization.

Influence can be a reduction in manpower, while the mass dismissal, salaries reduced, and so forth.

Political uncertainty in the form of threats of political change can cause stress for employees or employees of an organization. Technological uncertainties are environmental factors that cause stress. The emergence of new technological innovations are a threat to employee that cause stress in which new innovations can make a person's skills and experience of employees obsolete within a very short time.

- **Organizational Factors**

The sources of this stress categorized into several factors: task demands, role demands and interpersonal demands, organizational structure, leadership, organization and level of organization of life itself.

Task demands is a factor associated in the work of someone with whom these factors include the design of individual work (autonomy, diversity of tasks, level of automation), working conditions and layout of the work was physically. Demands of the role of the relationship with the pressure exerted on a person as a function of which played a certain role in an organization. Stress can arise when an employee is experiencing role overload, so he made the role more than that allowed by time. In addition, role ambiguity can also cause stress which the expectations of the role is not clearly understood and employees are uncertain about what to do.

Interpersonal demands is the pressure created by another employee, means a lack of social support from colleagues and poor interpersonal relationships can cause considerable stress.

The organizational structure determines the level of differential (difference) in the organization, the level of rules and regulation and where decisions are taken. Excessive rules and lack of participation in decision-making regarding an employee is a potential source of stress.

Organizational leadership can lead to stress through a managerial style that is applied so as to create a different problem and pressure for employees.

States that stress can be avoided by "taking distance" with the sources of the stressor or the things that cause stress, but not all types of sources of stress are to be shunned.

Here are presented several types of sources of stress (stressors) that should be avoided, it looks like does not feel appreciated, do not have goals, family problems, unmet needs, lack of time, boredom, frequent changes occur, insecurity and conflict with people other. Dessler (2007), says that an important source of job stress and personal environment. Environmental factors that can lead to the occurrence of stress include work schedules, work pace, job security, and travel to and from work, the number and nature of the customer or client. Personal factors include people who are addicted to work, tolerance of uncertainty, patience, self-dignity, health patterns, exercise, work and sleep.

Every individual has a different reaction to the stressors encountered that can be physical or mental disorders.

By considering the understanding of stress and stress causes mentioned above, it is necessary to also determine how stress reactions or symptoms of an employee to stress. The symptoms are a reaction to stress that one's various self-control depends on the ability of the individuals concerned.

There are some symptoms of stress that is to become nervous and feel the anxiety in chronic, irritable, aggressive, not relaxed or an uncooperative attitude and so forth.

Robbins (2008) divides the symptoms of stress in three general categories, namely:

- Physiological symptoms. In these symptoms of stress can create changes in the metabolism to increase heart rate and respiratory rate, increased blood pressure, cause headaches, and cause a heart attack.
- Psychological symptoms. Stress on these symptoms can lead to dissatisfaction and job-related stress can appear in other psychological conditions, such as: tension, anxiety, irritability, boredom and procrastinator.
- Symptoms of behavior. Symptoms of stress are associated with behaviors that include changes in productivity, absenteeism, and employee exit rate, as well as changes in eating habits, increased smoking and alcohol consumption, rapid speech, restlessness, sleep disturbances.

Gibson et al (2006), explains that the effects of stress are many and varied. Positive impacts may include self-motivation, stimulus to work hard, improve inspiration to enjoy a better life and so forth.

**Table 1  
Similarities and Differences of Previous research**

<b>Title</b>	<b>Difference</b>	<b>Equation</b>	<b>Results</b>
Analysis of Work Stress on Morale (Roziana, 2006)	Differences on the object under study: - Previous research conducted at PT. Petro Kimia Gresik - Research now being done in BPR Mustakim Bank	Using multiple linear regression model	There are variables significantly influence of stress on employee morale
The effect of Work Stress of Work Motivation (Novitasari, 2005)	Differences on the object under study: - Previous research that serves as the independent variable is the variable of job stress and work motivation as the dependent variable - Research is now acting as an independent variable is the variable organizational design and job stress as the dependent variable	Using multiple linear regression model	There are variables significantly influence the stress of work motivation

## 2.1. Hypothesis

Based on the above research, a hypothesis that can be drawn:

Ha1: Stress caused by environmental factors significantly influence employee morale BPR Mustakim Bank.

Ha2: Stress is due to individual factors significantly influence employee morale BPR Mustakim Bank.

Ha3: Stress due to organizational factors significantly influence employee morale BPR Mustakim Bank.

## 3. Research Method

This research was conducted in BPR Mustakim Bank Banda Aceh with the object of research is stress and morale.

The population in this study was all employees of BPR Mustakim Bank. The sampling technique was conducted using census, all respondents as the sample given the limited amount thus respondents in this study were all employees and the management of BPR Mustakim Bank with a total number of employees 40 people.

### 3.1. Data Analysis Tools

To see the effect of stress on employee morale BPR Mustakim Bank used multiple linear regression method. The mathematical form of multiple linear regression formula is as follows:

$$Y = a + b_1X_1 + b_2X_2 + b_3X_3 + e \quad (1)$$

Description:

Y = Morale

a = Constant

b<sub>1</sub> = regression coefficient of environmental variables

b<sub>2</sub> = regression coefficient of variable individual factors

b<sub>3</sub> = regression coefficient of variable organizational factors

X<sub>1</sub> = variable environment

X2 = variable individual factors  
X3 = variable organizational factors  
e= Error terms

### 3.2. Hypothesis Testing

- Ho1: Stress caused by environmental factors, no significant effect on employee morale BPR Mustakim Bank.  
Ha1: Stress caused by environmental factors significantly influence employee morale BPR Mustakim Bank.  
Ho2: Stress is due to individual factors no significant effect on employee morale BPR Mustakim Bank.  
Ha2: Stress is due to individual factors significantly influence employee morale BPR Mustakim Bank.  
Ho3: Stress due to organizational factors no significant effect on employee morale BPR Mustakim Bank.  
Ha3: Stress due to organizational factors significantly influence employee morale BPR Mustakim Bank.

### 3.3. Operational Variables

The operational variables in this study are as follows:

**Table 2**  
**Operational variables**

No.	Variable	Operational Definition	Indicators	Measuring scale	Scale	Item Question
<b>Dependent</b>						
1.	Morale	Robbins (2008), morale is a mental condition or behavior of individual workers and groups that create a deep pleasure in self-employment to work diligently in meeting goals set by the company.	Timely	1-5	Interval	A1
			Working better	1-5	Interval	A2
			Condition	1-5	Interval	A3
			Like	1-5	Interval	A4
<b>Independent</b>						
2.	Environmental Factors	as seen from the economic discontent, political dissatisfaction, the uncertainty of technology in the workplace that cause stress (Robbins, 2008)	Relations with superiors	1-5	Interval	B1
			Technology	1-5	Interval	B2
			The workplace	1-5	Interval	B3
			Working equipment	1-5	Interval	B4
			Layout	1-5	Interval	B5
3.	Individual Factors	as seen from problems within the family, economic problems are not enough and versatile personality who quickly get bored or stress (Robbins, 2008)	Problem	1-5	Interval	C1
			Economic Issues	1-5	Interval	C2
			Personality	1-5	Interval	C3

4.	Organizational Factors	as seen from the higher task demands in the workplace, the nature of authoritarian leadership, the relationship between subordinates with superiors is not good that trigger stress levels at work (Robbins, 2008)	Demand	1-5	Interval	D1
			Discipline	1-5	Interval	D2
			Leadership style	1-5	Interval	D3

### 3.4. Test Reliability

Reliability testing is intended to test the extent to which measurement results can be trusted. High and low reliability coefficient of reliability is described through a certain number. In reliability testing is used test the internal consistency of the test system against a particular group, then counted in test scores and consistency of the various items that exist in the group. According to Malhotra (2007) the minimum acceptable coefficient above.

### 3.5. Validity

Validity test intended to measure the extent to which the instrument used actually measure what it should be measured. To determine whether the instrument has been developed has validity or not, so the instrument is expected to be consistent. Validity test in this study was using Test Product Movement Person Coefficient of Correlation with the help of SPSS (Statistical Product and Service Solution).

## 4. Result and Discussion Research

Effect of Source of Stress on Employee Morale Increase / decrease in employee morale in the work must have been influenced by various factors, such as stress factors experienced by either of the environment, individuals, and organizations. In addition, influenced by other factors such as motivation, education and training and is also influenced by the procedures and work rules are defined.

Each organization will always strive for their employees have high morale, because with high morale are expected to increase work performance and automatically targets of the organization will be achieved.

From the research it can be obtained from the final equation estimator is as follows:

$$Y = 3,044 + 0,606X_1 + 0,249X_2 + 0,274X_3$$

The coefficient of determination (R<sup>2</sup>) value 0.867 or 86.7 percent indicate that stress from environmental factors, individual factors, and organizational factors can affect the morale of 86.7 percent, and the remaining 13.3 percent is influenced by other variables such as motivation, discipline work and others. Correlation coefficient (R) of 93.1 percent described the stress variables visits from environmental factors, individual factors, and organizational factors are very closely related to the morale variable that is equal to 93.1 percent.

### 4.1. Hypothesis Proof

To test the hypothesis in this study the author uses the F test and t test that is at the level of confidence (confidence interval 95%) or error of 0.05.α rate (alpha) T test done to see how the influence of explanatory variables on the dependent variable in a partial, whereas the F test performed to see how the influence of explanatory variables on the dependent variable simultaneously on the dependent variable.



This illustrates that the stress variables visits from environmental factors, individual factors, simultaneously significant effect on employee morale at the BPR Mustakim Bank. From the test hypothesis above we can conclude that the  $H_a$  in this study received while  $H_o$  was rejected.

## **4.2. Conclusions and Suggestions**

The study, which has done so, can take the conclusion as follows:

1. The results obtained determinant coefficient ( $R^2$ ) value of 0.867 or 86.7 percent indicate that stress from environmental factors, individual factors, and organizational factors can affect the morale of 86.7 percent, and the remaining 13.3 percent is influenced by other variables such as motivation, work discipline and others.
2. Correlation coefficient (R) of 93.1 percent described the stress variables visits from environmental factors, individual factors, and organizational factors are very closely related to the morale variable that is equal to 93.1 percent.
3. Tests conducted by using t test turns out to all independent variables in this study partially significant effect on employee morale BPR Mustakim Bank.

As with knowing that the factor of stress experienced by employees in BPR Mustakim Bank, which is caused by environmental factors, individuals, and organizations, so in this case are some suggestions made for authors who want to improve morale employee, that is:

1. To avoid and deal with employee stress caused by environmental factors such as lack of control technologies such as computers, internet and Chairman of BPR Mustakim Bank so should can do a more intensive training and involving employees from all groups. Even better would be if the employee recruitment skills possessed by potential employees were also considered so that employees are all employees received a ready to use.
2. Employees are also expected to continue to develop themselves in various sciences and to manage the stress experienced by both is essential. Where the level of stress in certain limits can still be tolerated and sometimes to further improve the morale of an employee.

## **5. References**

- As'ad, Mohd. 2000. *Industrial Psychology*. Liberty Press.
- Calhoun. 2002. *Organizational Behavior*. New York: McGraw-Hill.
- Davis, Keith & Newstrom WJ. 2001. *Organizational Behavior*, New York: McGraw-Hill.
- Dessler, G. 2007. *Human Resource Management*. 8th edition. New Jersey: Prentice-Hall, Inc.
- Gibson, Ivancevich & Donnelly. 2005. *Organizations : Behavior, Structure, Processes*, Irwin, Inc.
- Gujarati, Damodar. 2004. *Basic Econometrics*. 4th edition, Tata McGraw-Hill.
- Hawari, D. 2001. *Al-Quran: Science Psychiatry and Sanity*. Grafika Press.
- LPPM. 2002. In *Organizational Behavior Management*. AJB Bumi Putera 1912 Jakarta.
- Malhotra, Naresh K. 2007. *Review of Marketing Research*. M.E. Sharpe. ISSN 1548-6435
- Novitasari. 2005. *The effect of Work Stress of Work Motivation*. Journal of University C.Petra.
- Robbins, S. P. 2008. *Organizational Behavior*. USA : Pearson Education, Inc. Publishing Prentice Hall.
- Roziana. 2006. *Analysis of Work Stress on Morale*. Journal of Social Science, Volume 12 No.1.
- Sonda, P. 2005. *Human Approach and Organization of Personnel Development*. G. A. Press.

## **Route Determination and Scheduling Distribution of Raw Materials in Fast Food Franchise Restaurant**

Abstract

[kimberlyfebrina@yahoo.co.id](mailto:kimberlyfebrina@yahoo.co.id)

Study Program Industry Engineering Al Azhar University Medan  
Jl.Pintu Air IV No.214 Medan

PT. Fast Food Indonesia, Medan branch is one of the fast food franchise restaurant franchises of Kentucky Fried Chicken distributing raw materials through the distribution center (DC) to each area retail outlet (RO). Transportation and distribution method is a method that aims to find the shortest route to maximize the distribution function with on time, in the right amount, and good condition (in this case) the physical condition of raw chicken and fried chicken seasoning. The objective of this study is to seek out solutions through Logware program by proposing them provement of distribution and scheduling deliveries of raw materials (chicken and spices) that minimize distribution costs and maximize distribution of raw materials using LOGWARE software version 5.0. Logware is a collection of selected software programs that is useful for analyzing a variety of logistics/supply chain problems and case studies Recently, the distribution system is done on the basis of the proximity of the consumer, regardless of the ratio of the number of requests to the vehicle capacity. This study used a survey method. These results showed that the proposed distribution of raw materials resulting in cost savings, eliminate redundancy visits, and optimize travel time and mileage Settlement with Vehicle Routing Problem (VRP) dan its related variants is at the heart of scientific research for optimizing logistic planning. One important variant of the VRP is the Vehicle Routing Problem with Time Windows (VRPTW), where it is assumed that a number of clients must be served by a fleet of vehicles operating from a central depot. Solving this problem requires finding a set of minimum cost routes for the vehicles, while observing a number of pre-defined problem constraints.

**Key words : Ruote, Logware, Franchise**

### **INTRODUCTION**

Routes and scheduling of vehicles is an important component in the distribution and transportation systems in a fast-food restaurant franchise industry. The problem is the vehicle routing by considering the combinatorics of significant economic value in the logistics system, known as the Vehicle Routing Problem (VRP). Distribution system, is one important part of supply chain management. The guarantee of the availability of products intime and sufficient quantity is determined by a good distribution system. Improper adjustment of the distribution system will cause uncontrolled stocks of raw materials and the condition of the warehouse, inefficiency in time delivery, fleet scheduling and driver as well as a variety of other things that have an impact on profits and reduced competitiveness. Franchising is a partnership between the giver pattern franchisee (franchisor) and a recipient of the franchise which gives the advantage of the existence of alternative sources of funding, capital savings and efficiency (Soetawi, 2002). Method of franchise supply chain management approach which is related to the management of information flow, product flow, and the flow of money in its core activities of inventory, or the so-called inventory (Indrajit and Djokopranoto, 2002). Supply chain management products focuses on product flow between the company, since most upstream to the most downstream, where the flow of these products rely on the function of inventory management (inventory). Managing the flow of products to the right is one of the main objectives of supply chain management.

The location of the study is one of the fast food franchise companies with has 14 retail outlets (RO) and scattered in the city of Medan and have 1(one) as the central distribution warehouse (distribution center /DC) located in District Tembung Medan and 15-wheelers 4 (freezer and non freezer) in the implementation of its activities, the distribution of raw materials only based on estimates only and are more focused on the allocation of vehicles to RO in the same area so that excess vehicle capacity sexing occurs in the absence of standards in the grouping. This excess capacity should be utilized for other RO in distributing to not only be in one area alone. In addition, the grouping of these areas do not produce these solutions. These will be pursued only be determined by trial and error driver. However, the large number of distribution points(RO) are scattered in the city of Medan and surrounding areas making it difficult for the driver to determine the order of the route to be taken. This will result in one of them is a long distance, so if this continues it will lead to costs incurred by the company to distribute the goods to be great (inefficiency). In addition, the problem encountered in the field are delays in delivery of raw materials, the presence of defective raw materials during delivery and lack of supervision by the franchisee quantity of raw materials in RO, deliveries are made on request of the respective RO regardless of the composition of the raw materials required (batch). This can lead to inefficiencies in scheduling a vehicle and the driver as well as the inventory control of raw materials. Route determination is an issue that should be resolved as long as it is still manual only based on intuition and estimates of the warehouse (DC) and is based on the proximity between RO existence of supply chain management can reduce the accumulation of raw materials in the warehouse so that the franchisee incurred costs to a minimum. During consideration of the only companies in managing capacity constraints, the weight of goods transported and the location, did not consider whether the route mileage has been minimal or not so the fuel costs incurred are also not necessarily minimal. In general overview distribution system version company can be seen Figure 1.

The problem often encountered is related to the distribution to make decisions regarding the routes that can optimize mileage or travel costs, travel time, number of operated vehicles and other resources available. Optimization problems can be formulated distribution of goods mathematically as a Vehicle Routing Problem (VRP).

The problem of transportation and distribution of raw materials and products can be modeled as the Vehicle Routing Problem (VRP). VRP models will result in the number of vehicles for each customer visit. Each route starts and ends at the same place called depot. In addition VRP models also ensure that the total demand on a route does not exceed the capacity of the vehicle operating. The use of VRP models are expected to minimize the total distance traveled and the number of vehicles. Time constraints on the model of VRP is a complicated issue. In such problems, the only manufacturer to ship the product at certain intervals each day. To solve this problem used Vehicle Routing Problem Time Windows (VRPTW) is a model of VRP by adding time constraints. VRP formulation is intended to form a number of routes with minimum cost or distance, such that (1) each route begins and ends at a place called the depot, (2) each customer visited exactly once by one particular vehicle, (3) the total demand each route does not exceed the capacity of the vehicle, (4) the total duration of each route (including travel time and service time) does not exceed a certain time limit. An additional constraint VRP with a presence service interval (time windows) on each customer, named VRP time windows (VRPTW). In this study, heuristic methods will be used to find solutions of the model VRPTW faced. The solution can be searched with the help of software Logware version 5.0. One method is the completion VRPTW heuristic method is the method of approach. Unlike the exact methods such as branch and bound, this method is more advantageous because it can solve large problems with small computational time. Some research on heuristic methods for the settlement of VRPTW was conducted among others by Laporte and Semet (2002), Cordeau et al. (2002) and Braysy and Gendreau (2005). This study aims to analyze a number of

routes to the cost or the distance and number of vehicles to a minimum and maximize the number of goods under also determines the shortest route for each vehicle in the fast-food franchise companies in the city of Medan in order to provide solutions to management in order to improve supply chain there. There fore, researchers want to conduct research in order to find solutions to optimize the delivery schedule and used vehicles and warehouses (DC) which ensures the availability of raw materials at each outlet (RO). It is necessary for determining the route and scheduling delivery of raw materials that can overcome the above problems by optimizing all available resources in order to obtain a solution that can minimize the total cost of transportation.

### **Problems Limitations**

In effort to produce effective results, then use the boundary problem for the channel distribution RO process in Medan and its surrounding areas Channels RO chosen because the largest amount in comparison with other existing channels. Then the RO channel is the channel that has the shortest distribution chain compared with other existing channel:

1. There is only one depot (warehouse) or DC.
2. The calculation of distance is directly based on the calculation of the Google Maps website and symmetrically determines the coordinates X and Y.
3. The capacity of all cars transporter 3(freezer) are the same
4. Each place is only visited once.
5. Goods should not be returned.
6. The demand when the vehicle is running does not affect old planning. The demand will be included as further travel plans
7. It is not influenced by external factors such as the state of nature, strikes, traffic jams and etc.
8. Request is fulfilled only one visit in 2 days (safety stock 3days). Because cycle 1 x 2 day delivery, and so that more safe then plus 1day and vehicles carrying raw materials every2 days to the same RO.
9. The number of vehicles needed by warehouse (DC) for the distribution of goods is assumed always available with a capacity that is uniform for the same type of goods at eachRO.
10. The speed of vehicle is constant.
11. RO data request has been determined before hand.
12. Without discussing the optimization time.
13. Distance is directly proportional to the cost incurred, so that the minimum distance presents the minimum cost.
14. Stock of raw materials (chicken and frozen raw materials) is assumed for 3 days.

### **2. Review of Literature**

According to the Council of Logistics Management (CLM) in the Ballou (1998) logistics is a process of designing, implementing and controlling the efficient, cost flow and storage of raw materials, storage of goods in process, finished products and other information related to the starting point to the end point of a production process to meet the needs of consumers. In particular logistics system performance level to be achieved is a balance between quality of service expected by the customer with costs incurred to achieve company goals. Logistics system performance is affected by two factors, namely a number of factors related to the service level of service provided to customers, and cost factors related to the magnitude of cost incurred by the company in connection with the level of service provided to customers. One of the most influential factors in the improvement of customer service is on time delivery. In these cases associated with enterprise distribution system.

## Vehicle Routing Problems (VRP)

Vehicle Routing Problem (VRP) is a search solution that includes determining the number of routes, each route traveled by a vehicle that starts and ends at the depot of origin, in order to serve all customers while still meeting operational constraints that exist, and also to minimize the cost transportation. In Figure 2 below shows where there is a distribution depot should carry the goods to the consumer. In Figure 2 there are 12 consumers look scattered with distance and the coordinates are different. While in Figure 3 can be seen that there is a line that connects the consumer or the consumer called the depot route of the vehicle. From figure 3 it can be seen how in the distribution of vehicles forming a specific route, namely 14 consumers reached by sending the products based on a predetermined route.

## RESEARCH METHODOLOGY

### Research Location

The study was conducted at the Distribution Center (DC) KFC Franchise is at the center of Medan (warehouse) the distribution of raw materials for the purposes of operational activities at each RO as aslap-food restaurant franchise that produces KFC fried chicken in the field, specifically in the field Kecamaran-Tembung and at the head office of PT. FastFood Indonesia as a franchise branch of Medan, Jl. Mataram Medan.

### Research Methods

This study used a survey method and in-depth interviews with relevant parties. The method used to form the route so as to minimize the objective function is a heuristic algorithm. Route determination is carried out in two phases: initialization to construct the initial solution and improvement phase to improve solutions a available.

### Data Collection Techniques

The collected data are in the form of secondary data and primary rehabilitated and reconstructed interviews and in-dept interview with related parties understood the distribution process at the company. Coverage is limited to the discussion in the research process for the distribution channel retail/outlet (RO) which only includes the working area of Medan and surrounding are as consisting of 14 RO and 1DC, can be seen in Table 1 below. RO channels elected because the largest amount in comparison with other existing channels.

**Table 1. Outlet and DC KFC in Medan City**

No	Name	Code Rate	Address	Coordinate	
				X	Y
1	Mataram	MTR	Jl. Mataram	3.584	98.664
2	Adam Malik	ADM	Jl. H. Adam Malik	3.594	98.668
3	Medan Mall	MML	Jl. MT. Haryono	3.588	98.686
4	Marelan	MRL	Jl. Medan-Marelan	3.628	98.663
5	Walikota	WLK	Jl. Walikota	3.571	98.672
6	Sutomo	STM	Jl. Sutomo	3.598	98.681
7	Sun Plaza	SNP	Jl. H. Zainal Arifin	3.583	98.672
8	Teladan	TLD	Jl. Sisingamangaraj a XII	3.565	98.692
9	Katamso	KTS	Jl. Brigjen Katamso	3.549	98.688
10	Medan Fair	MFR	Jl. Gatot Subroto	3.592	98.663
11	Millenium	MML	Jl. Kapten Muslim	3.599	98.644
12	Imam Bonjol	PLN	Jl. Imam Bonjol	3.569	98.678
13	Asia Mega Mas	AMM	Jl. Asia	3.586	98.705

14	Home Centre DC	HCR	Jl. Gagak Hitam Tembung	3.567 3.597	98.626 98.748
----	-------------------	-----	----------------------------	----------------	------------------

### Data Processing Method

Once all the information and data obtained, it is followed by formulating the problem of data processing existing distribution as a model of VRP. Then proceed Logware soft ware programs that run in the 5.0 version of the Microsoft Office XP 2007 as a tool to seek a solution of the VRP models encountered. Data obtained as: layout RO, ROquery, loading and unloading time at the RO. Timing to shed the uniform at RO is 8:00 to 16:00 pm, which is assumed as 0 at 8.00 and at 16.00 and 1 vehicle freezer capable of loading up to 48 containers of raw materials with the composition of 4x4x3 (3 layers). Stock of raw materials (chicken and frozen raw materials) is assumed for 3 days. Vehicle carrying the raw material every 2 days to the same RO. Specified safety stock 3 days for cycle 1x2-day delivery, and so that more safety then added 1 day. Then another assumption, namely for 1 chicken assumed to average 1.2 kg (8 pieces). The composition of herbs per piece 30% per piece (0.045 g). The number of chickens per batch is 100 pieces (piece).

## RESULT AND DISCUSSION

### 1. Problem Analysis

Company engaged in fast food holder franchise KFC franchise is a trade mark of Yum! Brands, Inc., head quartered in Louisville, Kentucky, United States. Company in running its activities in the field has 14 RO and 1 DC and 7 truck wheels 4. The discussion in this study is limited only to the distribution of raw materials (chicken and raw material frozen) from DC to each RO in Medan. Chicken distribution channel chosen because it is the channel that has the most short-chain distribution in comparison with other existing channels. Data used in the calculation of the distribution of the 14 RO performed based on the data requirements (demand) on average per day in each RO is determined from the average product sales per day, which has been converted in to units of the group (batch). Distribution activities to each RO conducted from the DC warehouse using container (plastic box) for each batch its done every day at 07.30-14pm. Beside delivering the raw material, driver and helper also do loading and overhaul on the determined place. The schedule of distribution for the material is determined by manager of DC and related to route scheduling, each driver distribute into the available RO. The capacity of truck freezer for 1100 chicken and usually in one delivery there is also other material. In table 2, it is assumed that average wage of each chicken = 1,2 kg = 8 piece and 1 batch = 100 piece = 150 gr/piece.

**Table 2. The Need of Chicken Raw Material**

No	Name of RO	The Need of Chicken Raw Material (piece)
1	Mataram	1000
2	Adam Malik	800
3	Medan Mall	650
4	Marelan	650
5	Walikota	550
6	Sutomo	600
7	Sun Plaza	620
8	Teladan	650
9	Katamso	420
10	Medan Fair	900
11	Millenium	770
12	Imam Bonjol	750
13	Asia Mega Mas	800
14	Home Centre	950

Source : the data is processed (2014)

Based on the calculation result using Logware version 5.0, the distribution of raw material into RO using 2 freezer vehicles with 4 (four routes) of the delivery for 2 day, with total distance 656 km, and the cost for fuel Rp 721,100 (Table 3).

**Table 3. Result of Data Processing with Logware 5,0**

Route	Vehicle	Start Time	Return Time	No of Stops	No of Batch	Route Dist (km)	Route Cost (Rp)	Stop Description
1	A	08:00 AM	03:40 PM	3	42	203	223.111	Mataram, Home Centra, Millenium
2	A	08:28 AM	03:05 PM	4	38	171	187.605	Sutomo, Katams o, Walikota, Imam Bonjol
3	B	08:13 AM	02:52 PM	4	48	167	183.964	SunPlaza, Adam Malik, Medan Fair, Marelan
4	B	08:58 AM	01:32 PM	3	34	115	126.418	Asia Mega Mas, Medan Mall, Sm Raja
////////////////////				<b>14</b>	<b>162</b>	<b>656</b>	<b>721.100</b>	

Based on Table 3, it can be seen that the vehicle A, will serve seven (7) outlets (Mataram, Home Centra, Millennium, Sutomo, Katamso, Walikota, Imam Bonjol) for 2 (days) with operating costs (fuel) of Rp. 410 716 and load 80 batch of raw materials. As for the vehicle B, will serve seven (7) outlets (Sun Plaza, Adam Malik, Medan Fair, Marelan, Asia MegaMas, Medan Mall, Smraja) for 2(days) with operating costs (fuel) Rp. 310 382 and 82 batches of raw materials. On the existing condition, the company will operate with 7 cars and average fuel cost for Rp 1,400,000. Compared with Logware version calculation, the efficiency of fuel is for Rp 1,200,000 – Rp 721,000/2 days/2 vehicles and the number of freezer vehicle only for 2 units compared to the calculation version company for 7 units.

## 2. Analysis of Route

### A. Route version Existing Condition company.

In Figure1, it canbe seen the initial distribution route (method companies (prior to any offer of a given solution (before).

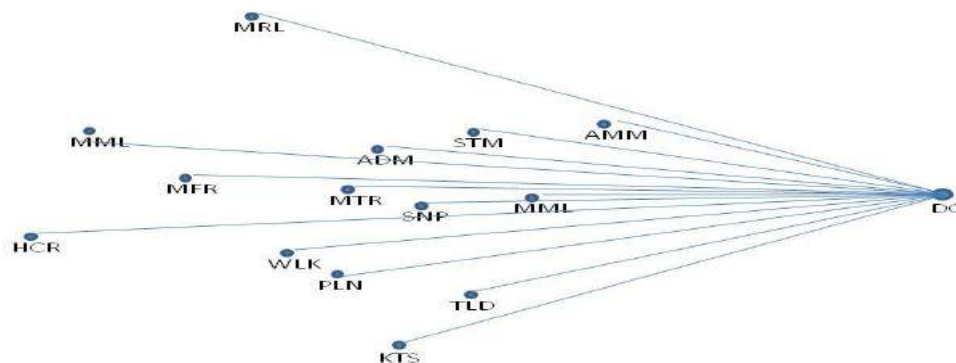


Figure 1. Route of products delivery distribution (before solution)

From Figure 1 it can be seen that the distribution of raw materials will lead to inefficiencies in the procurement of vehicles and drivers as well as in materials inventory control. The Company distributes raw materials to every RO based stock control (manual) without taking in to account mileage and routes.

### B. Solutions (Improving Route) with Logware5.0

In this research, a solution to the distribution activities used Logware version 5.0 from DC to RO which is divided in to 4 routes. The four route can be seen in Figure 2, 3, 4 and 5 (as a solution).

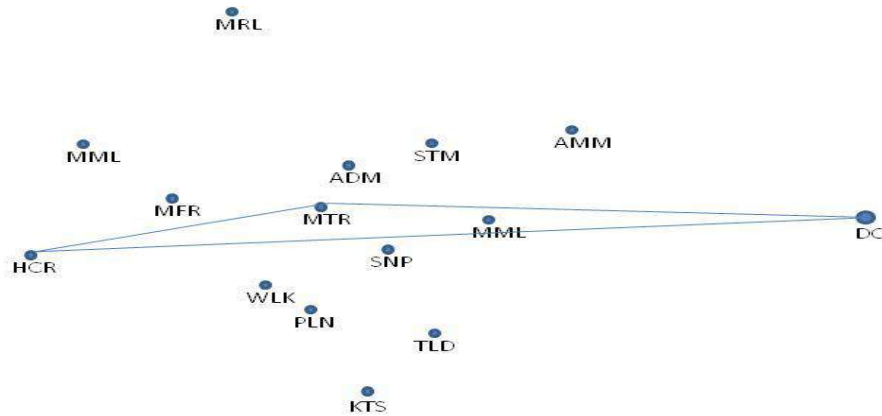


Figure2 (Route 1-1)

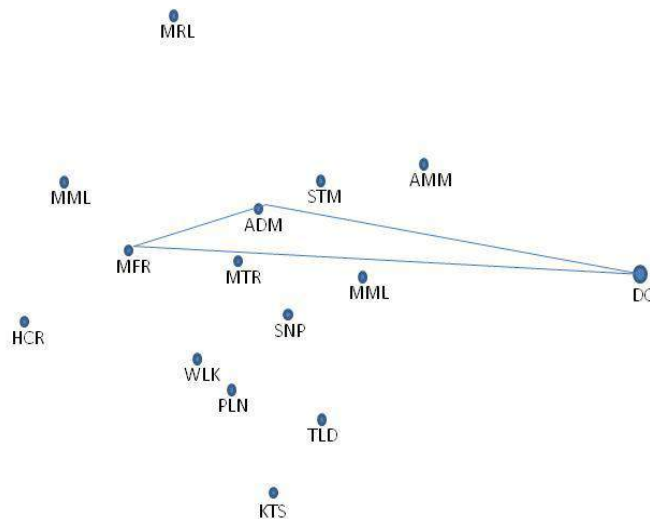
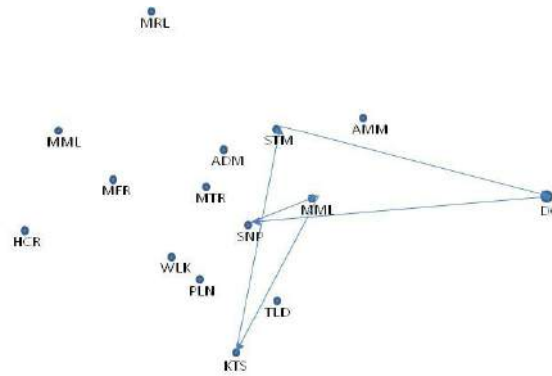
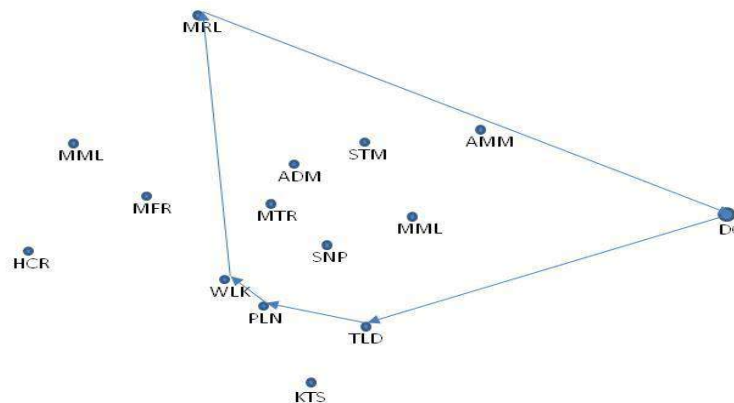


Figure3 (Route 1-2)





**Figure 4 (Route 2-1)**



**Figure 5 ( Route 2-2)**

## Conclusion

Based on the research results of the determination of the distribution of raw materials by using Logware, it generated as follows:

1. Distribution of raw materials from DC needed to RO 2 vehicles with a total mileage of 656 km and the cost of fuel (gasoline) to Rp721,100, -While the result ingmileage of enterprise methods is 1945 km, meaning with Logware program can deliver results better (efficient) and methods of the company by reducing the distance of 189 km.
2. Time distribution can be used because of the shorter distance.
3. The first vehicle (A) serve 7 RO ie: Mataram, Home Centra, Millennium, Sutomo, Katamso, Walikota, Imam Bonjol) for 2 (days) with operating costs (fuel) of 80 batches of Rp410 716 and contains material balm. Where as for vehicle B, it will serve seven (7) outlets (Sun Plaza, Adam Malik, Medan Fair, Marelana, AsiaMegaMas, MedanMall, SmRaja) for 2(days) with operating costs (fuel) of Rp. 310. 382 and contains 82 batches of raw materials.
4. Distribution costs of raw materials (postage) is cheaper by 20% compared with the calculation of the enterprise version..
5. Distribution system that scheduled the amount of stock on each outlet can be controlled.
6. Rate guarantee availability of raw materials will be met.
7. The efficiency of the use of the ware house floor at each out let will be optimized for stock control.

## Suggestion

1. Safety stock should be forced minimum 3 days as there is once delivery within 2 days.
2. Arranging drivers schedule and a ware house clerk schedules DC outlet and ware house personnel should be integrated in accordance with a predefined operating hours.

3. The company should rearrange the route to minimize efficiency and effectivity using the freezer vehicle.

## REFERENCES

- Ahuja RK, Magnanti TL, Orlin JB. 1993. *Network Flow: Theory, Algorithms and Applications*. New Jersey: Prentice Hall.
- Ballou, R.H., Business Logistics Management: *Planning, Organizing and Controlling The Supply Chain*, Fourth Edition, Prentice Hall, Inc. New Jersey, 1998.
- Ballou, R.H., (C) Copyright 1992-2004 *Selected Computer Programs For Logistics/Supply Chain Planning*. LOGWARE Version 5.0. Weatherhead School of Management Case Western Reserve University. All rights reserved
- Cordeau J-F, Gendreau M, Laporte G, Potvin JY, Semet F. 2002. A guide to vehicle routing heuristics. *Journal of the Operational Research Society* 53: 512-522.
- Indrajit, R and Richardus Djokopranoto. 2002. *Konsep Manajemen Supply Chain: Cara Baru Memandang Mata Rantai Penyediaan Barang*. PT Gramedia Widiasarana Indonesia. Jakarta
- Kallehauge B, Larsen J, Madsen OBG, Solomon MM. 2005. *Vehicle routing with time windows*. Di dalam Desaulniers G *et al.*, editor. *Column Generation*. New York: Springer. 67-98.
- Laporte G, Semet, F. 2002. *Classical heuristics for the capacitated VRP*. In Toth P, Vigo D, editor. *The Vehicle Routing Problem*. Philadelphia: Siam. 109-128.
- Larsen J. 2001. *Parallelization of the vehicle routing with time windows*. [Ph. D Thesis]. Denmark: Department of Mathematical Modeling. Lyng by: University of Denmark.
- Logware version 5.0. 2004. R.H. Balliou. All Right Reserve.
- Mendelsohn, Martin. 1993. *Franchising: Practise Guidance For Franchisor and Franchisee*. Pustaka Binaman Pressindo. Jakarta.
- Pujawan, N. 2005. *Supply Chain Management*. Guna Widya. Surabaya.
- Purnadi, R. 2009. *Cepat Saji Eksis* di Ibukota. [www.swa.co.id](http://www.swa.co.id). 5 Oktober 2009.
- Soetawi. 2002. *Manajemen Agribisnis*. Bayu Media dan UMM Press. Malang
- Widjaja, G. Waralaba, cetakan.1, PT Raja Grafindo Persada, Jakarta, 2001

# ANALYSIS OF UNCONTROLABLE INFLUENCE FACTORS TO STOCK RETURN IN MANUFACTURING COMPANY USING DATA PANEL METHOD

<sup>1</sup>Seno Hadi Saputro

<sup>1</sup> STMIK Atma Luhur, seno.hadi@atmaluhur.ac.id, 081918961754

## ABSTRACT

This research is performed to evaluate the influence of macro variable (uncontrollable) toward stock return. External factors (uncontrollable) is a factor that comes from outside the company that can not be controlled. These factors are economic growth, inflation and interest rate deposit dollar exchange rate to dollars (Sudiyatno, 2009). Methodology research as the sample used purposive sampling with total acquired 26 company sample listed in bursa efek indonesia. Data analysis with multiplier regression of random effect datapanel method. The results obtained are the empirical evidence of analysis show as PDB, TBD and inflation have a negative influence and significant toward stock return and exchange rate not influence and significant toward stock return.

Keyword : *PDB, TBD, Inflation, exchange rate and return*

## I. INTRODUCTION

Investors put shares in the capital market aims to generate revenue in the long run not only aim in the short term. Revenue desired by shareholders is dividend income (dividend yield). While the capital gain is the difference between the market price of the current period to the previous period's price. Dividend yield and capital gain is a total return that can be received by the investors in the long run. In making an investment decision, investors analyze the stock return movement phenomenon that is certainly suspected by investors to see its internal factors. Look at external factors (uncontrollable) from that company also. External factors (uncontrollable) used in this study is economic growth, deposit rates, inflation and the rupiahs exchange rate to dollars (exchange rate) (Dwijayanthi, 2009).

Choosing manufacturing company as a subject studied because its fact seen in the Indonesia stock exchange shows that the number of companies (issuers) listed on the stock exchange has decreased began in 2005. Manufacturing industry conditions in Indonesia, particularly in the growth of non-oil industry in 2004 amounted to 7.51%. Listed since 2005, the condition continued to decline to 5.86%. This growth rate continues to decline to 5.27% in 2006, 5.15% in 2007, in 2008 4.05% and is decreased in 2009 in the amount of 2.56% (www.bps.go.id).

The global crisis that began in 2010 hit almost all the countries in Europe and America led to an economic growth decrease that is significant but it turned out contrary to the conditions of manufacturing industry in Indonesia's growth that significantly increase. Recorded growth medium and large industries in 2013 increased by 6.01% compared to 2012. The growth of medium and large industry in 2012 increased by 4.12% compared to 2011. The growth of medium and large industry in 2011 increased by 5.56% compared to 2010. The growth of medium and large industry in 2010 increased by 4.45% from the year 2009 (www.bps.go.id). From BPS data can be seen that in 2010 and 2013 manufacturing industry experienced a trend of positive growth after the 2005 to 2009 experienced a significant decline.

Based on the description above, it is very interesting to make a research about uncontrollable influence factors to stock return in manufacturing company.

### 1.1 Review Of Literature

According Sjahrial (Sjahrial, 2007: 104): "Return is the result obtained from investments. Return (return) can be divided into two, namely: the return that realized (realized return) and the expected

return. Realized return is the return that have occurred. Returns that have been realized is important because it is used as a measure of corporate performance and is calculated based on historical data. Expected return is the return that expected to be acquired by investors in the future. Unlike the realized returns that are already happening, its expected return has not happened yet. Total return is the overall returns of an investment in a given period. Total return is often referred to refund only. Total return consisting of capital gain (loss) and yield can be formulated as follows:

Return = Capital gain (loss) + Yield

a. Capital gain (loss)

Capital gain (loss) is the difference in price relative to the price of investment is now the last period. Thus the formula capital gain (loss) can be expressed as follows:

$$\text{Capital Gain/Loss} = \frac{P_t - P_{t-1}}{P_{t-1}}$$

If the price of the investment now ( $P_t$ ) is higher than the price of the investment period ( $P_{t-1}$ ) This means there is a capital gain (capital gain), if the opposite occurs then there is a loss of capital (Capital loss).

b. Yield

Yield is a percentage of periodic cash receipts for a certain period of investment price of an investment. for stocks, the yield is the percentage of dividends on stock prices earlier period. For bonds, the yield is the percentage of the loan interest earned on bond prices earlier period. Thus the yield formula can be stated as follows:

$$\text{Yield} = \frac{D_t}{P_{t-1}}$$

So that the return (return) can be formulated as follows:

Return (return)=

$$\frac{P_t - P_{t-1} + D_t}{P_{t-1}} \text{ atau } \frac{P_t - P_{t-1}}{P_{t-1}} + \frac{D_t}{P_{t-1}}$$

## 1.2 Related Work And Hypothesis

According to Bambang Sudiyatno <sup>(Sudiyatno, 2009)</sup> external factors (uncontrollable) is a factor that comes from outside the company that can not be controlled. These factors are economic growth, inflation and interest rate deposit dollar exchange rate to dollars (exchange rate). Indonesia's economic growth rate is measured by the amount of gross domestic product (GDP) (Agency for Statistics center in 2013). The amount of growth in gross domestic product can be formulated as follows:

$$\text{PDB} = \frac{\text{PDB}_t - \text{PDB}_{t-1}}{\text{PDB}_{t-1}} \times 100\%$$

The deposit rates obtained by adding long-term debt with short-term debt each company is then divided by the loan interest rate prevailing in the year and multiplied by 100%. Furthermore, the change is calculated by means of the amount of interest in year t minus the year t-1 divided by interest in year t-1.

Inflation is used national annual inflation which is a change Consumer Price Index (CPI) from month to month t-1 <sup>(Dwijayanthi, 2009)</sup> and formulated with:

$$\text{Inflasi} = \frac{\text{IHK}_t - \text{IHK}_{t-1}}{\text{IHK}_{t-1}} \times 100\%$$

According to A. Nasir <sup>(Azwir, 2011)</sup>, a currency exchange rate is actually a price of a country's currency against other currencies. Currency exchange rate is the result of interaction between the forces of demand (demand) and supply (supply) that occurs in the foreign exchange market.

Based on research Chairul Nazwar <sup>(Nazwar, 2008)</sup>, a significant effect of economic growth on stock returns. This means that economic growth is one of the factors that affect stock returns. However, research conducted Ni Kadek Ayu Suartini <sup>(Suartini, 2011)</sup> found that economic growth had no effect on stock returns. There is a contradiction between research Chairul Nazwar (2008) and Ni Kadek Ayu Suartini (2011). Hence the contradiction, the authors wanted to examine the relationship of economic growth variables with stock returns. Based on these explanations, hypotheses formulated as follows:

### **H1: Economic growth has positive effect on stock returns**

Based on research Nasir<sup>(Azwir, 2011)</sup>, the deposit interest rate have a significant effect on stock returns. This means the deposit interest rate is one of the factors that affect stock returns. However, research conducted Enny Pudyastuti<sup>(Pudyastuti, 2000)</sup> found that the deposit rate has no effect on stock returns. There is a contradiction between research Nasir (2011) and Enny Pudyastuti (2000). Hence the contradiction, the authors wanted to examine the relationship variable interest rates on deposits with stock returns. Based on these explanations, hypotheses formulated as follows:

### **H2: The deposit rate positive effect on stock returns**

Based on research Ratna Prihantini<sup>(Prihantini, 2009)</sup>, Inflation effect on stock returns. This means that inflation is one of the factors that affect stock returns. However, research conducted Ika Kartika<sup>(Kartika, 2008)</sup> found that inflation has no effect on stock returns. There is a contradiction between the study Prihantini Ratna (2009) and Ika Kartika (2008). Hence the contradiction, the authors wanted to examine the relationship of inflation variables with stock returns. Based on these explanations, hypotheses formulated as follows:

### **H3: Inflation positive effect on stock returns.**

Based on research Suyanto<sup>(Suyanto, 2007)</sup>, the value of exchange rates negatively affect stock returns. This means that the exchange rate is one of the factors that affect stock returns. However, research conducted A. Nasir<sup>(Azwir, 2011)</sup> find that the exchange rate has no effect on stock returns. There is a contradiction between research Suyanto (2007) and A. Nasir (2013). Hence the contradiction, the authors wanted to examine the relationship variable rate with stock returns. Based on these explanations, hypotheses formulated as follows:

### **H4: Exchange rate negative effect on stock returns**

## **II. METHODOLOGY**

There are 26 companies that will be sampled in this study. In this research sampling conducted by the sampling method aims (purposive sampling)<sup>(Sekaran, 2006)</sup>, namely the determination of the sampling techniques with particular consideration / Judgment Sampling in order to obtain a representative sample in accordance with the criteria of the sample as follows:

- a. Shares of companies listed on the Stock Exchange for 7 consecutive years from 2007 until 2013 periods
- b. The Company publishes the annual financial statements of the period December 31, 2007 until December 31, 2013
- c. Companies that always changes the positive assets of the 2007 until 2013 periods

The method used to analyze the effect of economic growth, deposit rates, inflation and exchange rate (exchange rate) on stock returns is a panel data analysis. The software used in this study is a Microsoft Excel 2007 for classifying the data and then processed using software Eviews 4.1.

The method of analysis used in this study is multiple regression analysis with panel data. Panel data or called longitudinal data is a group of individual data were studied during a certain time frame. Panel data is a combination of time series data and cross section data.

**Table 1 26 Companies were used as samples for research**

No	Company Name	Code
1.	PT. Tiga Pilar Sejahtera Food, Tbk	AISA
2.	PT. Fast Food Indonesia, Tbk	FAST
3.	PT. Mayora Indah Indonesia, Tbk	MYOR
4.	PT. Sinar Mas Agro Resources and Technology Tbk	SMAR
5.	PT. Ultrajaya Milk, Tbk	ULTJ
6.	PT. Gudang Garam, Tbk	GGRM
7.	PT. Akr Corporindo, Tbk	AKRA
8.	PT. Ekadharma International, Tbk	EKAD
9.	PT. Indocement Tunggul Prakarsa, Tbk	INTP
10.	PT. Semen Gresik, Tbk	SMGR
11.	PT. Lion Metal Works, Tbk	LION
12.	PT. Astra International, Tbk	ASII
13.	PT. Astra Otoparts, Tbk	AUTO
14.	PT. Gajah Tunggal, Tbk	GJTL
15.	PT. Intraco Penta, Tbk	INTA
16.	PT. Multisrada Arah Sarana, Tbk	MASA
17.	PT. Selamat Sempurna, Tbk	SMSM
18.	PT. United Tractor, Tbk	UNTR
19.	PT. Darya-Varia Labortoria, Tbk	DVLA
20.	PT. Kimia Farma, Tbk	KAEF
21.	PT. Kalbe Farma, Tbk	KLBF
22.	PT. Pyridam Farma, Tbk	PYFA
23.	PT. Taisho Pharmaceutical Indonesia, Tbk	SQBB
24.	PT. Tempo Scan Pacifik, Tbk	TSPC
25.	PT. Mandom Indonesia, Tbk	TCID
26.	PT. Unilever Indonesia, Tbk	UNVR

**Source : ICMD 2007-2013**

Model data panel consists of three types:

a. Ordinary Least Square

Ordinary Least Square method known as Common estimation effect. In this approach does not pay attention to the individual dimension or time. It is assumed that the behavior of the same data between companies in different period of time.

b. Fixed Effect

Fixed understanding this effect is based the difference between companies but intercept is the same across time (time invariant). In addition, the fixed effect model also assumes that the regression coefficient (slope) remains between companies and between time

c. Random Effect

In this model we will estimate panel data where possible disturbance variables interact over time and between individuals.

## 2.1 Model Selection Tests in Data Panel Method Processing

### 2.1.1 Chow Test

According to Agus Widaryono <sup>(Widaryono, 2013)</sup> chow test done to choose the model that is used Common Effect or Fixed Effect. The test is performed with the following hypothesis:

H0 : Common Model Effect

H1 : Fixed Effect Model

Basic rejection of the null hypothesis is by using the formula:

$$\text{Chow} = \frac{(ESS1 - ESS2)/(N - 1)}{ESS2/(NT - N - K)}$$

ESS1 : Residual Sum Square outcome prediction models Common Effect

ESS2 : Residual Sum Square outcome prediction models Fixed Effect

- N : Number of cross section data  
T : Number of time series data  
K : Number of explanatory variables

If the value of statistics chow test results is greater than the F table, then Ho is rejected, and vice versa.

### 2.1.2 Hausman Test

According to Agus Widaryono<sup>(Widaryono, 2013)</sup> Hausman test is done to choose the model that is used fixed effect or random effect. The test is performed with the following hypothesis:

- H0 : Random Effect Model  
H1 : Fixed Effect Model

If the value of the Hausman test results greater than X2 table, then Ho is rejected, and vice versa.

### 2.1.3 Lagrange Multiplier Test (LM Test)

According to Agus Widaryono (Widaryono, 2013) lagrange multiplier test is done to choose the model that is used common effect or random effect. The test is performed with the following hypothesis:

- H0 : Common Model Effect  
H1 : Random Effect Model

If the value of the Lagrange multiplier test results greater than X2 table, then Ho is rejected, and vice versa.

## 2.2 Model Evaluation

### 2.2.1 T Test (Partial Test)

Partial test (t test) was performed to test the significance of the influence of the independent variables, namely GDP, TBD, inflation and exchange rate individually on the dependent variable, namely Return stock companies listed on the stock exchange in 2007 until 2013. Stages of testing are:

a. Formulate a hypothesis

H0 :  $b_1 \dots b_4 = 0$ , meaning that there is no influence of the independent variables on the dependent variable.

Ha :  $b_1 \dots b_4 \neq 0$ , meaning that there is an influence of the independent variables on the dependent variable

b. Determining the significance level of 0.05 or 5%

c. Determine the decision by comparing t with t table with the following criteria:

- If  $t > t$  table or  $t$  count  $< t$  table, then

Ho is rejected

- If  $t < t$  table or  $t$  count  $> t$  table, then

Ho is accepted

### 2.2.2 R Squared

R-Squared is the proportion of variation in the dependent variable that can be explained by the independent variables. R-Squared has a range of  $0 \leq R\text{-Squared} \leq 1$ . If R-Squared value is 1 then 100 percent of the variation in the dependent variable can be explained by the independent variables. Whereas if the R-Squared value is 0 then the variation in the dependent variable can not be explained by the independent variables.

## III. RESULT AND DISCUSSION

### 3.1 Data Analysis

#### 3.1.1 Chow Test

$$\text{Chow} = \frac{(ESS1 - ESS2) / (N - 1)}{ESS2 / (NT - N - K)}$$

$$\text{Chow} = \frac{(101,3758 - 93,76081)/(26-1)}{93,76081/(26.7-26-4)}$$

Chow = 0,493801

From the Chow test results obtained 0,493801 while the magnitude of F table with N-1 degrees of freedom (25) and NT-NK (152) is 1.4591. since F count < F table then H0 is accepted. It can be concluded that the model is more appropriate Common Effect used in this study than Fixed Effect.

### 3.1.2 Lagrange Multiplier Test

From the lagrange multiplier test results obtained 90.005660 while the critical Chi Squares value with n-1 by 25 at  $\alpha = 5\%$  is 38.885. because the lagrange multiplier test >  $\chi^2$  table then H0 is rejected. It can be concluded that the model is more appropriate Random Effect used in this study than Common Effect.

From the results of the Chow test and the Lagrange multiplier test above, the method used in this study Random Effect. Panel data model using a random effects model (Random Effect) shown in Table 2.

**Table 2 Panel data model using a random effects model (Random Effect)**

Variabel	Coefficient	t-Statistic	Prob
C	8,576260	1,954765	0,0522
PDB	-48,74233	-3,446724	0,0007
TBD	-22,75533	-4,171560	0,0000
Inflasi	-7,239814	-2,165011	0,0317
LOG(Kurs)	-0,837096	-0,691113	0,4904
Weighted Statistics			
R-Squared	0,137684	Mean dependent var	0,414267
Adjusted R-Squared	0,118196	S.D. dependent var	0,826874
S.E. of regression	0,776471	Sum squared resid	106,7146
Durbin Watson stat	2,051469		

**Source: Secondary data that has been processed with Eviews 14**

## 3.2 Discussion

The hypothesis in this study suggests that GDP has a positive effect on stock returns. Significant value t test on GDP by 0.0007 (sig < 0.05) this means a significant GDP on stock returns, while the regression coefficient has a negative direction of -48.74233 (t count < -2.074) This means that the GDP effect on return stock. This is not consistent with the hypothesis, which means that H1 is rejected. The existence of negative influences between GDP with stock returns due to economic growth during the study period was not too high. High economic growth should increase investor interest in investing in the stock market. However, in this peneliotian turns investors are less interested in the stock investment in manufacturing enterprises. The possibility of investors choose to invest in other sectors such as gold, property, bonds and so forth. The existence of a negative response from investors this makes the return of manufacturing companies into decline.

The hypothesis in this study suggests that the TBD has a positive effect on stock returns. T-test at a significance value of 0.0000 TBD (sig < 0.05) this means a significant TBD on stock returns, while the regression coefficient has a negative direction of -22.75533 (t count < -2.074) means TBD effect on return stock. This is not consistent with the hypothesis, which means that H2 is rejected. The existence of negative influences between TBD with stock returns is because investors are not interested to invest capital market as payments to be received from the stock is smaller than the benefit that will be received from interest on deposits. Finally, capital market stock price will decline drastically. Stock price down will result in a decrease in stock returns.



The hypothesis in this study suggests that inflation has a positive effect on stock returns. Significant value t test on inflation of 0.0317 (sig <0.05) this means a significant inflation on stock returns, while the regression coefficient has a negative direction of -7.239814 (t count <-2.074) This means that the inflation effect on return stock. This is not consistent with the hypothesis, which means that H3 is rejected. High inflation becomes negative signal to investors. Investors will tend to give up its shares in the event of an increase in inflation. In times of rising inflation, investors are likely to react to sell the shares held as usually investors will require a high level of return. This step was taken in anticipation of the possibility of increased risk of stocks caused by the increase in inflation.

The hypothesis in this study suggests that the exchange rate has a positive effect on stock returns. Significant value t test on the exchange rate of 0.5150 (sig> 0.05) This means that the exchange rate is not significant on stock returns, while the regression coefficient has a negative direction of -0.837096 (t count> -2.074) means the value exchange rate has no effect on stock returns. This is not consistent with the hypothesis, which means that the H5 rejected. The increase or decrease in the value of this rate was not responded by investors. The lack of response from investors has resulted in the decline in stock prices. If the stock price goes down, then the return will go down.

### **3.3 R Squared**

The estimation results using a random effects model (Random Effect) shows the value of the coefficient of determination R<sup>2</sup> or on the results of these estimates can be seen that 13.77 percent of the diversity of company stock return the sample to the period of time from 2007 until 2013 can be explained by the independent variables (GDP, TBD , inflation and exchange rate), while 86.33 percent is explained by other variables outside the model. The variables thought to be influenced by the company's financial performance.

## **IV Conclusions, Suggestions and Recommendations**

### **4.1 Conclusions**

- a. In the selection data panel model using Random Effect data panel models after testing by using the Chow test and Lagrange Multiplier test
  - From the Chow test results obtained 0,493801. It can be concluded that the model is more appropriate Common Effect used in this study than Fixed Effect.
  - From the lagrange multiplier test results obtained 90.005660. It can be concluded that the model is more appropriate Random Effect used in this study than Common Effect.
- b. The significance of individual test results show the results:
  - GDP, TBD and inlasi significant negative effect on stock returns
  - Exchange rate has no effect on stock returns

### **4.2 Suggestions**

- a. In next research needs to add other variables that affect stock returns such as liquidity, profitability, solvency and so forth.
- b. We recommend using the assets of the company not only to get a change of assets were positive but also negative changes in assets required to obtain more accurate information
- c. The period of the study and the sample used should be increased and extended to several sectors of the company resulting in more accurate information

### **4.3 Recommendations**

For company management, the manager should be able to pay attention to the company's growth and the exchange rate that investors interested in buying shares offered by the company

## V REFERENCES

- Azwir, Nasir dan Mirza, Achmad. (2011). Pengaruh nilai kurs, inflasi, suku bunga deposito dan volume perdagangan saham terhadap return saham pada perusahaan perbankan yang terdaftar di BEI. *Jurnal Ekonomi* Volume 19 No. 4.
- Dwijayanthi, Febrina (2009). Analisis pengaruh inflasi, BI Rate dan nilai tukar mata uang terhadap profitabilitas bank periode 2003-2007, *jurnal karisma* Vol 3 (2) : 87-98, 2009.
- Kartika, Ika. (2008). Pengaruh inflasi, tingkat suku bunga dan kurs rupiah terhadap return saham perusahaan manufaktur di BEJ. Skripsi. Universitas Negeri Malang.
- Nazwar, Chairul. (2008). Analisis pengaruh variable makroekonomi terhadap return saham syariah di Indonesia. *Jurnal perencanaan dan pengembangan wilayah*. Vol. 4 No. 1 Agustus 2008.
- Ni kadek ayu suartini (2013), Perbandingan CAPM dengan APT dalam memprediksi return saham, *E-Jurnal akuntansi universitas udayana* Vo. 2 No. 3 Maret 2013
- Prihantini, Ratna. (2009). Analisis pengaruh inflasi, nilai tukar, ROA, DER dan CR terhadap return saham (Studi kasus saham industry real estate and property yang terdaftar di BEI periode 2003-2006). Tesis. Program Pascasarjana Universitas Diponegoro. Semarang.
- Pudyastuti, Enny (2000), Analisis pengaruh return pasar, tingkat inflasi, tingkat suku bunga deposito terhadap return saham individu pada industry dasar dan kimia yang terdaftar di BEJ periode 1997-1999, Program pascasarjana universitas diponegoro.
- Sekaran, U. (2006). *Research methods for business*, Jakarta : Salemba Empat.
- Sjahrial, Dermawan. (2007). *Manajemen Keuangan Lanjutan*. Jakarta : Mitra Wahana Media.
- Sudiyatno, Bambang (2009). Peran beberapa indikator ekonomi dalam mempengaruhi resiko sistematis perusahaan manufaktur di bursa efek Indonesia Jakarta. *Jurnal dinamika keuangan dan perbankan*.
- Suyanto. (2007). Analisis pengaruh nilai tukar uang, suku bunga dan inflasi terhadap return saham sector properti yang tercatat di bursa efek Jakarta tahun 2001-2005. Tesis. Universitas Diponegoro Semarang.
- Widaryono, Agus (2013). *Ekonometrika pengantar dan aplikasinya disertai panduan eviws*, Yogyakarta : UPP STIM YKPN  
[www.bps.go.id](http://www.bps.go.id)

## VI SHORT AUTHORS BIODATA



Seno Hadi Saputro, MM is working as Lecture at Department of Computer Science STMIK Atma Luhur Pangkalpinang, Babel

# Intellectual Capital Empowerment Through Comprehensive Intellectual Capital Management (An Interpretive Accounting Research)

Sigit Hermawan

Faculty of Economic, University of Muhammadiyah Sidoarjo

Email: [sigithermawan@umsida.ac.id](mailto:sigithermawan@umsida.ac.id)

Phone: +62318945444; Smartphone: +6285730900014

## Abstract

This study aimed to explore the IC empowerment through Comprehensive Intellectual Capital Management (CICM). This study was conducted using interpretive accounting research (IAR) especially interpretive research (IR) in management accounting. The informants of this study were managers of pharmaceutical companies, ex-managers, observers of pharmacy industry, and researchers of Intellectual Capital (IC). Data analysis technique was performed by stages, i.e. data collection, data reduction, data display, and conclusion. The result of this study indicated that there were three stages in IC empowerment, i.e. knowledge management, innovation management, and intellectual property management. Pharmaceutical companies in Indonesia were averagely still in knowledge management and innovation management stages. Only some big pharmaceutical companies have aimed intellectual property management. Empowerment could be performed on all components of IC (human capital, structural capital, and relational capital) and on all levels of CICM (knowledge management, innovation management, dan intellectual property management). IC empowerment through CICM by interpretive accounting research proved that such non-financial IC research could explore hidden assets and explore non-financial activities that could be used to develop company strategies to reach company goals and improve business performance and competitive advantage.

Keywords: Comprehensive Intellectual Capital Management, Management Accounting, Interpretive Accounting Research

## 1. Introduction

Intellectual capital (IC) according to Bontis et al (2000), IFAC (1998), Marr (2008) consists of Human Capital (HC), Structural Capital (SC), dan Relational Capital (RC). As stated by Hermawan (2013) that according to some study results, IC proves to influence business performance, improve company value, improve organization effectiveness, competitive advantage and also create welfare for companies. Some positive advantages seem not known by managers of pharmaceutical companies. According to a study by Hermawan et al (2012), the managers do not know and understand much about their IC components, do not know how to measure and manage, both IC individually and IC in integrated way. It is strengthened by a study by Sampoerno (2007) that IC management by pharmaceutical companies in Indonesia is still weak. Only 17% of pharmaceutical companies in Indonesia prove that they can compete in export market especially in Southeast Asia.

Meanwhile, IC empowerment efforts must be continuously performed because a difference occurs between the obtained advantage and existing implementation reality. One of IC empowerment efforts can be performed by Comprehensive Intellectual Capital Management (CICM) (Al-Ali, 2003). CICM consists of three stages, i.e. knowledge management, innovation management, and intellectual property management. When observing each existing stage in CICM, this concept is perfect to implement because it is complete for each stage and for each IC component. Such IC empowerment effort will be appropriate if it uses non-financial IC study as an effort to explore hidden assets, explore non-financial activities, communicate value trigger, and recognize company characteristics in CICM stages. By considering the recommendation from Hermawan (2013) that non-financial IC study more uses qualitative research with interpretive as an approach. Therefore, this study aims to explore IC empowerment through CICM using interpretive accounting research.

## 2. Literature Review

### The Resource Based Theory dan An Intellectual Capital View of the Firm

Basic theory used in this study is the resource based theory and an intellectual capital view of the firm (ICV). The resource based theory (RBT) (Wernerfelt, 1984; Barney, 1991) was used in this study because according to this theory, company would obtain competitive excellence and superior performance if it could use company resource, both tangible resource and intangible resource. However, along with developing intangible resource in knowledge economy area, the role of intangible asset is getting big, including IC. Even Belkaoui (2003) states that IC qualification as strategic asset is located on potential relationship between IC and firm performance. It means that IC is strongly related to company performance, both financial and non-financial. Meanwhile, technically ICV states that IC is an important factor for company profit in long-term and company performance in knowledge-based economy (Hsu dan Fang, 2009; dan Kong, 2010). IC also provides an important contribution for performance because its capability in using knowledge resources effectively. As a new theory or view, ICV is expected to provide a higher potential for empirical testing compared to RBV that represents certain narrower aspects connected to company competition excellence. In this way, ICV can be perceived as a complement to understand knowledge-based view broadly, as an effort to improve superior performance (De Castro *et al.* 2011).

### Comprehensive Intellectual Capital Manajemen (CICM)

Meanwhile, some theories regarding IC empowerment and management have been stated by some experts, one of them is Comprehensive Intellectual Capital Manajemen (CICM) by Neirman Al-Ali in 2003. CICM model is a model designed to manage all forms of IC through three stages, i.e. knowledge management, innovation management, and intellectual property management. The thing differentiating this model with other IC management is in the keyword of "comprehensive". It means that Al-Ali (2003) tries to provide a solution to manage IC starting from collecting and exploring knowledge resource, use it for innovation, and use it for company competitiveness and obtaining profit.

The three stages or functions of CICM are the basic of business management that will always exist in each organization. The first stage related to resource providing for operational or production. The second is the continuation of the first stage because in this stage, the existing resources will be changed with various processes to produce valuable asset. In the third stage, the resource that has been valuable will be attempted to be elevated so as to optimize for the purpose of stakeholders.

Based on the business management stage, CICM model tries to connect between business stages and function classification of IC. While the stages of IC management and development consist of:

1. Knowledge resources,
2. Innovation resources and processes,
3. Intellectual property.

In each stage, it is then processed by connecting each stage with IC components (HC, SC, and RC). The following are examples of connection between each stage of CICM with IC component presented in Table 1.

**Table 1. Types and Stages of CICM Model-Based IC**

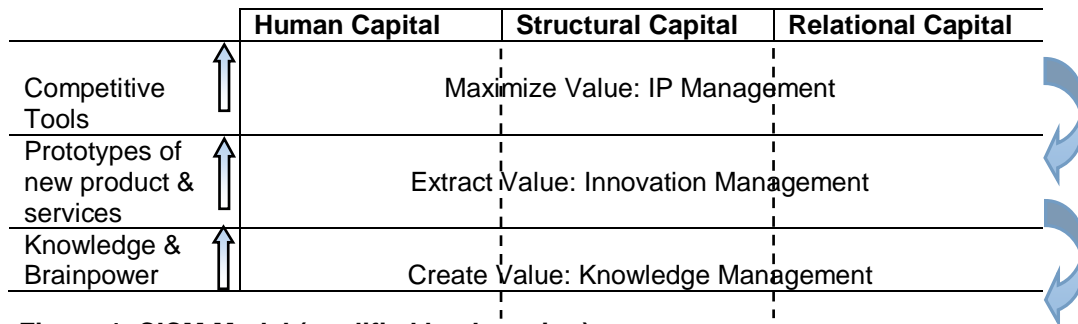
IC Stage of Development	Human Capital	Customer Capital*	Structural Capital
Knowledge Management Stage	Tacit knowledge, experience, brainpower, vision	Experience, knowledge, relations, networks	IT databases, knowledge base, best practices, culture
Innovation Stage	Ideas, product, concept, skills	Ideas, product, concept, feedback, relationship	Work systems, business processes
Intellectual Property Management Stage	Know-how, know why	Brand identity, reputation, strategic alliances	Patents, trademarks, copyrights, trade secrets

\* In this writing, Customer Capital is equalized with Relational Capital

**Source: Al-Ali (2003: 64)**

Based on Table 1, it can be seen that each stage of IC development is always connected to HC, RC, and SC. In each stage, maybe there are some same examples of resources, but different in context of resource providing and development. For example, experience in knowledge management state for HC and RC. Similarly in innovation management stage, there is ideas that also exists in HC and RC.

If each stage in Table 1 is explained, CICM model will appear as Figure 1.



**Figure 1. CICM Model (modified by the writer)**  
(Source: Al-Ali, 2003: 66)

Based on Figure 1, it can be seen that CICM model used to manage IC on each level in business and each stage will support the next stage. The first step, i.e. creating value by performing knowledge management on knowledge and brainpower. The first step will support the second stage, i.e. extracting value by performing innovation management on prototypes of new products or services. The last or third step is maximizing value on intellectual property management on competitive tools. Through the three stages, the distribution of each stage is clearly observable so that it is expected that overlapping of step will not occur in IC management.

Based on Table 1 and Figure 1, the next steps can be arranged related to management objectives of the three stages of IC management. Table 2 describes that matter.

**Table 2. Management Objectives and Purposes for CICM**

CICM Stage	IC Group	Purpose	Management Objectives
Knowledge Management	Raw knowledge resources	Value Creation	Recognize and leverage the knowledge resources required to sustain the organization's processes
Innovation Management	Innovation processes and resources	Value Extraction	Unleash and Reconfigure innovation resources to create new ways of doing business and new products faster
Intellectual Property Management	Intellectual property	Value Maximization	Enable the use of intellectual property to enhance the organization's competitive positioning and revenue generation

**Source: Al-Ali (2003: 66)**

Each stage will bring different management objective consequence. The objectives provide a guide for management to measure performance in each stage. The first objective is to manage good information flow and knowledge resource, i.e. to facilitate organizational learning and maintain all things related to organization (value creation). The main objective is to change a set of management objectives, i.e. in providing main knowledge resource for organization by connecting the objectives and facilitating knowledge distribution to encourage the existence of organization knowledge. Investment in this stage is not like in the other two stages because investment in this stage is a very long-term investment and unrelated to finance directly. Management innovation stage has main objective, i.e. extracting value from all existing knowledge resource for organization using innovation process. IC management challenge in this stage is how to manage innovation resource by strengthening the network inside and outside company so as to rearrange various things related innovation to gain trust from market. The last

stage, i.e. managing intellectual property is optimizing value on stakeholders using legal company property as competitiveness and marketing tools.

### **3. Research Method**

This study explored IC empowerment through CICM using interpretive accounting research. The intended meaning is the meaning of what felt and experienced by key informants on CICM concept and competitive advantage. To understand the meaning, the researcher used qualitative interpretive research approach (Strauss and Corbin, 2003) and more specifically as interpretive accounting research (IAR) or interpretive research (IR) in management accounting (Lukka and Modell, 2010). Thus, analysis unit of this study was opinion or comment of key informant on CICM concept and competitive advantage.

Data were collected in three methods, i.e. in-depth interview, focus group discussion (FGD), and documentation. In-depth interview was conducted with each informant. FGD was conducted by selecting some appropriate informants and documentation was conducted by archiving some secondary data, both existing in pharmaceutical companies and in other sources. With this method, complete data were obtained according to intended purpose of this study.

Informants of this study were managers of pharmaceutical companies (KK, ER, DS, AP informants), supervisor (NA informant), ex-managers (YAS informants), IC researchers (ZF and WH informants), and pharmacy industry observers (UA and DH informants). Thus, in this study, there were ten key informants. Key informants from pharmacy manager element consisted of HRD manager, operational or production manager, and marketing manager. The use of key informants from manager element was absolutely implemented because it was related to three components of IC, i.e. human capital that was a representation of HRD, structural capital that was a representation of operational or production department, and RC as a representation of marketing department. It was in accordance with a study by Hermawan (2013) that the three managers had important roles in IC management in pharmaceutical companies. The determination of informants in this study was conducted by judgment and snowball (Mashall, 1996). Judgment was conducted at the beginning before conducting field research, while snowball was conducted when field research was ongoing.

Data validity test was conducted by credibility, transferability, dependability, and confirmability test (Senton, 2004). Credibility test was conducted by method triangulation, data source triangulation, theory triangulation, and triangulation among researchers (Hussein, 2009; Rahardjo, 2010). Transferability test was conducted by arranging qualitative report that was understandable, clear, complete, trustworthy, and parsimony because in qualitative research, the researcher could not guarantee the level of transfer of a study on other situations. Dependability or auditability test was conducted by implementing audit process on all research processes. In this study, dependability test was conducted by senior researchers, i.e. Prof TS, Prof SS, and Dr. BP. Confirmability test was conducted by asking for comments from other IC researchers, i.e. IU, IU, SLWI, MBW, and SH.

Data analysis technique was implemented when the study was ongoing. It was in accordance with recommendation from Miles and Hubberman (1984) regarding data analysis technique for qualitative research. While the stages of data analysis were data collection, data reduction, data display, and conclusion. In data collection stage, the researcher collected all data obtained from in-depth interview, FGD, and documentation. After that, the researcher implemented data reduction by reducing some data that were not appropriate with the aim of this study. In this stage, the researcher used coding in data so that the data were divided into same themes according to the aim of this study. The next process was data display, i.e. the researcher presented the data that was reduced into same themes in form of narration so that the researcher could draw conclusion easily as the last stage in data analysis of qualitative research.

### **4. Result and Discussion**

To obtain study result that was appropriate with the aim of this study, the researcher implemented some research stages. The first stage was combining all data obtained and conducting credibility test, i.e. method triangulation and data source triangulation, at once. In this stage, the researcher collected data and testing the data validity at once. For example, the result of interview with informant A was cross-checked with the opinion of informant B or the

opinion of informant A was cross-checked with the result of documentation or the data of interview result and documentation were cross-checked with the data of FGD. It was quite possible because the qualitative researcher was the research instrument itself. In this stage, the researcher also conducted theory triangulation by comparing the result of this study and the theory used, for example, the knowledge-based theory (Sveiby, 2001), and the intellectual capital view of the firm (Brooking, 1996; Edvinsson and Malone, 1997). The second stage was implementing coding on the result of first stage process. Implementing coding facilitated the researcher to arrange same theme or concept as a result of this study. In coding process, some data were eliminated or unused because they were irrelevant with the aim of this study. While the result of this study form same data or concept from the result of data analysis are the following:

**Table 1. Same Concept or Theme**

Coding	Same Concept or Theme
A	Position of Pharmaceutical companies in Indonesia in CICM Stages
B	IC Empowerment in CICM Concept
	B1. IC Empowerment in Knowledge Management Stage
	B2. IC Empowerment in Innovation Management Stage
	B3. IC Empowerment in Intellectual Property Management Stage

**Date Source: Data Display of Coding and Data Reduction Result**

#### **A. Position of Pharmaceutical companies in Indonesia in CICM Stages**

When conducting interview and discussion with the informants related to CICM stages, the researcher explained first regarding management objectives of each CICM stage. The objective of knowledge management stage was to recognize and use knowledge resources needed to maintain organization process. The objective of innovation management stage was to accelerate and configure innovation resources to create new methods and new products more rapidly. The objective of intellectual property management stage was to use intellectual property to improve organization competitive position and obtain profit.

Based on description on objectives of CICM stages, the researcher asked the informants regarding which stage the average position of pharmaceutical companies in Indonesia was in. The informants responded that at that time, pharmaceutical companies in Indonesia were averagely in knowledge management and innovation management stage. Only some big pharmaceutical companies that had aimed for intellectual property management. Small and medium pharmaceutical companies were still in innovation management and knowledge management stage. It was because Indonesian pharmacy products were still *me too* products and *maklon* products. Regarding this matter was explained by informant ER as the following:

“If it is observed from the model, in my opinion, averagely still in the second stage, innovation management, and the first stage, knowledge management. Those aiming for the third stage are still few, only some in Indonesia, maybe the big ones have thought about that. But the low and medium classes are still in level 1 or level 2. Because the characteristic of products of pharmaceutical companies in Indonesia is still *me too* and *maklon* or producing medicines in other’s factory.” (Excerpt of interview with informant ER)

The statement from informant ER was the same as the opinion from informant KK, and clarified by informant AS, as the head of industry department of GP Pharmacy Indonesia, East Java. According to him, many pharmaceutical companies in East Java were still like Micro, Small, and Medium Enterprises. All activities were performed in one location, meaning that the facility for production, office, warehouse, and other was limited.

“In East Java, there are many that are medium and low level. Even there are some that are similar to Small and Medium Enterprises. So, all becomes one. For cooking, living room, bedroom still become one, that’s the parable. But, PT “I” and PT “BF” are already good.” (Excerpt of interview with informant AS)

Opinion similarity among informant ER, KK, and AS was as a part of data validity especially in credibility data of data source triangulation.

Based on the opinions of the informants, it could be known that pharmaceutical companies in Indonesia were averagely in knowledge management and innovation management stage. In knowledge management was mostly performed by low-class or small pharmaceutical companies. It was because the objective of knowledge management stage was to recognize and use knowledge resources and intangible assets needed to maintain organization process. The existence of words “maintain organization process” was the reason why the informants perceived that in this stage, companies still implement internal repair so that the business process could keep going or the company could survive.

The informants also perceived that pharmaceutical companies in innovation management were medium-level pharmaceutical companies. It was because the objective of innovation management stage was to accelerate and configure innovation resources to create new methods and new products more rapidly. The existence of words “innovation and new methods” was perceived by the informants that the companies started to find “exit” by new methods to develop products. Internal management was getting better so that the company effort to “exit” started to be implemented by innovation and new methods.

The informants also perceived that pharmaceutical companies in intellectual property management stage were high-level pharmaceutical companies. It was because the objective of intellectual property management was to use intellectual property to improve organization competitive position and obtain profit. The existence of words “intellectual property” caused the informants perceiving that the companies had had leader products and good brand image for products and companies. Similarly with words “organization competitive” meaning that the company was ready to compete in national, Asian region, and international level.

The informants’ perception could not be blamed, but it was not always right. It could not be blamed because based on text meaning of objectives of each CICM stage stated that. The opinion was not always right because based on in-depth interview with the informants, it obtained some examples that high-level pharmaceutical companies was also not good in managing HC. For example, pharmaceutical company BF that could be categorized as upper medium level company, but the HC management was not properly organized. Similarly, its organization culture (SC) still did not indicate a professional culture. Its RC also did not always use marketing-oriented strategies, but mostly used sales-oriented strategies.

## **B. IC Empowerment Through Comprehensive Intellectual Capital Management (CICM) Model**

To come at a conclusion about the IC empowerment, the researchers conducted an analysis of data at the time of data collection, coding, data reduction, and data analysis along with the theory that supports the interpretation, i.e., the knowledge-based theory (Sveiby, 2001), and the intellectual capital view of the firm (Brooking, 1996; Edvinsson and Malone, 1997). It is also intended as an attempt to do a credibility test or the credibility of the data, especially on the triangulation theory. According to the knowledge-based theory, companies need to manage knowledge in the knowledge-based economic era as it is today. To do so, companies need knowledge transfer or knowledge conversion also. Alternatively, it can also performs knowledge management. Meanwhile, an intellectual capital view of the firm stated that IC is an important factor for long-term corporate profits and performance in the era of knowledge. Therefore, the IC must be empowered. In this study IC empowerment is conducted by CICM model (Al-Ali, 2003)

Efforts to manage and empower the IC component can be through the CICM. CICM concept consists of three stages, namely knowledge management, innovation management, and intellectual property management. Each stage has a different purpose. Stages of knowledge management aims to create value (value creation), the stages of innovation management aims issued value (value extraction), and the stages of intellectual property management aims to maximize the value (value maximization).

### **B.1. IC Empowerment in Knowledge Management stage**

The purpose of the knowledge management stage is to identify and exploit knowledge resources needed to sustain the process of organization or business processes as well. Keywords of this objective are to recognize, utilize, and maintain. This means, that at this stage the company is still in the stage of recognizing prior knowledge resource or intangible assets



owned by companies then use it in order to survive in the business process. Thus, it can be said also that at this early stage the company is required to perform business processes properly in accordance with generally accepted procedures or companies that are in this stage it is still doing the internal management arrangements.

At that time, FGD also discussed about the characteristics of the pharmaceutical companies that are at this stage of knowledge management. FGD implementation intention is to acquire and sharpen the data as well as to test the credibility particularly triangulation method, triangulation of source, and triangulation among researchers. Pharmaceutical companies will be easier to identify the empowerment that must be done in optimizing the IC by identifying the characteristics of companies that are in the stages of knowledge management. In the opinion of the FGD participants that pharmaceutical companies that get the knowledge management level is still limited of its resources whether its human resources, finance and capital. Consequently, the development of HC, is still limited to general theories applicable because it can not bring in outside consultants who can give planned and well business advises. That is, the pharmaceutical companies in this stage indeed does not require high competence or only have a standard competency, that is only to produce the drug alone.

The characteristics of existing HC pharmaceutical company in CICM stages can also be mapped by its hierarchy. If it is still in the knowledge management stage called personnel, whereas if it in the management innovation stage is called human resource, and that in the intellectual capital stages is called human capital. Following is AP opinion:

"If in terms of function, the tendency of the company is still at the knowledge management level of the HC is still functioning as personnel. Then when they climbed into innovation management stage then it will turn into a human resources function and eventually became human capital for intellectual property management "(AP's Opinion on FGD)

Characterize in the SC component is internal management which is still not well ordered. It means, at this stage, the company's management is still not able to perform a variety of innovations and creations because it is still confused with management of intern problems and also keep the company survive. Resource limitations, such as engines, space, and equipment led to the inability of the company to produce drugs that are detailed and need special handling, such as injection, infusion, and sterile medicines. When viewed from the product, certainly not the leader product because the company still seeing the development of the market, about what products are well sold in the market, after that they will be produce *me too* product.

Characteristic associated with the RC owned by pharmaceutical company at this knowledge management stage is the pharmaceutical market share in the lower middle level. That is, naturally formed so. Relationships with doctor only appear in sub-urban doctors or lower-level health workers such as midwives. The use of advertising media as a promotional tool also has not been conducted. Similarly, the CSR activities, which are still limited even rarely conducted.

Based on the opinions of the informants, it may be an attempt to empower HC, SC, and RC owned by pharmaceutical companies. Some of empowerment that can be done is by the improvement in the process of employee recruitment or recruitment system that must be done in the right way, the standard of training shall be provided to the employee. Other efforts can be done with the existing knowledge sharing within the company, the minimum equipment that must be met to the satisfaction of CPOB for drug production, an improvement over the company's organizational culture and also the relationship between doctors which should be improved.

This is perceived by the informants about IC empowering knowledge management in stages. Empowerment which is still in its prior stages conducts internal reforming and also recognizes its knowledge resources. The beginning process which has to be empowered is revamping employee recruitment management system. The next process is to meet the standards that must be met by pharmaceutical companies related to the number of pharmacists. The standard to be met is a minimum of three pharmacists.

The next is to optimize the empowerment training that followed by employees. Usually what happens is the pharmaceutical company sent one of his employees for training or seminars, that employee must share knowledge gained to other employees. This is called

knowledge transfer. Knowledge sharing can also be done by dividing the experience possessed by senior employees to junior employees. Knowledge sharing and knowledge transfer can use the concept of SECI (Socialization, externalization, Combination, Internalization). It is important for the repairing and improvement of knowledge, skills, and attitude which is owned by the employees. Empowerment can also be done by giving satisfaction to strengthen the employee's loyalty.

Empowerment also shall be done on the SC component in knowledge management stages. Empowerment on a lean organizational structure should make pharmaceutical companies more efficient and effective in strategic decision making. Although the internal management is not well ordered, pharmaceutical companies must also be able to utilize a variety of intangible assets owned, although it is still very limited. Optimization of empowerment infrastructure, machinery, equipment, and information technology must be able to meet the requirements of CPOB. That is, all the resources and technology organizations should be empowered to meet the drug quality standards appropriate the CPOB requirements.

Empowerment on RC components should also be made at this knowledge management stage. It is usually done is to convince the doctor that *me too* products proprietary have the same qualities as a leader product. Another empowerment is to optimize the cooperation that has been done with other health professionals, or also expand cooperation with new users according to the ability of the company.

Based on the above results, the characteristics and the IC empowerment on the knowledge management stage are as follows:

1. The company is still limited in funding and therefore contributes to the development of HC. That is, HC still struggling on its own merits so can not innovate because there is no input or advice of a consultant or has not been able to do a study out of the company. HC also still not be able to innovate because they dwell on the tasks management and company's internal housekeeping.
2. HC held still very standard or do not require high competence. At this stage the employee more positioned as personnel.
3. The product produced was not a pharmaceutical product that is complicated because it takes machinery, equipment, and technology (SC) that meets certain specifications. Product (SC) generated still join the leader product. The company at this stage is still waiting for what product demanded by the market. Once the company knows it will be made a product that is *me too* product.
4. The RC's done already segmented into lower middle market share. Similarly, the doctors who become the working partners of pharmacy, will be segmented physician grade C or also suburban doctor, midwives, and health workers in the clinic-polyclinic.
5. HC Empowerment can be improved in the process of employee recruitment or recruitment system should be done in the right way according to the standards of training that must be given to the employee. Empowerment HC can also be done with existing knowledge transfer within the company. Knowledge sharing between experienced employees with new employees, or between senior employees with junior employees.
6. SC Empowerment is conducted in a lean organizational structure optimization in strategic decision making for more efficient and effective. Optimization of empowerment infrastructure, machinery, equipment, and information technology must be able to meet the requirements of CPOB.
7. RC Empowerment can be done by always keeping the physician relationship which must be maintained to be improved and always trying to find the new users from the other health personnel.

Based on these characteristics, the HC empowerment that can be done is the improvement in the process of employee recruitment or recruitment system that must be done in the right way according to the training standards that should be given to the employee. SC Empowerment can be done with minimal equipment procurement to be met to the satisfaction of CPOB for drug production, an improvement over the company's organizational culture, and maintain the quality of the product in accordance with CPOB. RC empowerment can be done by always keeping the physician relationship which must be improved.

Based on the above description, and also based on the meaning of the text on the knowledge management stages purposes, is true that a pharmaceutical company in this stage

still perform a management arrangement, still recognizes and tries to use its limited resources. Because of the limited resources both for HC, SC, and RC, pharmaceutical companies must be able to utilize it's owned to be empowered on its role in supporting the company's operations and performance. The way to do is to knowledge management process. In the process of managing this knowledge, pharmaceutical companies must be able to recognize and utilize the explicit knowledge and tacit knowledge of the company and employees. Explicit knowledge related to visible-knowledge, such knowledge is written, archived and spread in a book or other printed form. Tacit knowledge associated with invisible knowledge, such knowledge in the form of know-how, experience, skills, understanding that employees. In this process of knowledge management, small-scale level pharmaceutical company or below can utilize the explicit knowledge for various purposes, e.g. for the development of employee skills, to improve processes and procedures, as well as materials do networking with other parties. Pharmaceutical companies can also take advantage of tacit knowledge of employees which have to be converted into explicit knowledge. The experience and skills of employees in the form of tacit knowledge can be transformed into explicit knowledge, such as various kinds of rules, operating system procedures, or modules also work to improve the performance of the employee and the company.

Utilization of knowledge can also be done through the interaction of IC components. That is, knowledge transfer between the IC components can be associated with each other. Utilization of knowledge consists of six groups, namely knowledge transfer from HC to RC, knowledge transfer from RC to SC, knowledge transfer from SC to HC, knowledge transfer from the RC to the HC, knowledge transfer from SC to RC, and knowledge transfer from HC to SC. Table 2 describes the utilization of knowledge through the interaction of the IC component.

**Table 2.**  
**UTILIZATION OF KNOWLEDGE THROUGH**  
**THE INTERACTION OF IC COMPONENTS**

Knowledge transfers from HC to RC	Knowledge transfers from RC to SC	Knowledge transfers from SC to HC
Employees who had just finished training or seminars giving advice on market orientation or changes in consumer behavior of pharmaceutical products	The marketing sections, share experiences about what is perceived by the customer about the drug quality or both the packaging and solubility	Operational or production sections provide information about the new rules and regulations that exist in CPOB so training is necessary for the production employees
Knowledge transfers from RC to HC	Knowledge transfers from SC to RC	Knowledge transfers from HC to SC
The marketing sections giving advice on med rep quality when doing presentations with the doctor, and also the quality of the sales team	Operational sections provide training on new technologies that are used for drug database system and also companies customer	Senior managers give an explanation of the organization's strategic objectives plan

Source: Hermawan, 2012.

## **B.2. IC Empowerment in the Innovation Management Stages**

The management purposes of the innovation management stage are to facilitate and re-configure the resources of innovation to create new ways and new products more quickly. There are lots of keywords in the phrase, i.e. smooth, and re-configure, resource innovation, creating new ways, and new products. It means, the company has been able to identify knowledge resources, exploit, even started to accelerate and configure them into the resources of innovation. The company at this stage has begun established in matters of internal management that have started to "come out" to innovate and create new ways and new products.

At the time of FGD also discussed about the characteristics of the pharmaceutical companies in the innovation management stages. By identifying these characteristics, it will facilitate the identification of empowerment that must be done in order to optimize the

company's IC. Some opinions of the FGD participants is the product innovation can be done by reformulating or also by producing the new products. New products in the company concerned, but it already in the pharmaceutical industry. Some are of the opinion that innovation is not only creating new products in the company, but also to develop the business into a conglomerate business.

Characteristic of innovation in this stage is the source of innovation by the company can be derived from the company's consultants or also from the marketing team. Innovation has also been carried out by a separate department, the department of research and development. Innovations are reformulated or also business development towards the healthcare business. Innovation can also be a new product in the company, but in the market has long existed. That is, a new pharmaceutical company to innovate on the drug after the drug is a very good market share. Innovation is not only related to new products are produced, but also about cost efficiency and effectiveness of work.

Based on the opinions of the informants, it can be done an IC empowering in innovation management stages. HC Empowerment on innovation management stage is to provide training that really supports creativity and innovation. The result of knowledge, skills, and attitude of employees increased so as to empower all existing enterprise resources. At this stage, the employee is no longer functioning as personnel, but rather functions as human resources. The knowledge enhancement task can be done with short courses or even sending for special education in college.

Knowledge sharing and knowledge transfer also occurs at this stage, but the existence of a management consulting owned by pharmaceutical company that make the transferred knowledge become more meaningful and useful again. Management consultants will provide advice on a variety of things that exist in pharmaceutical companies, mainly related to human resources management. Knowledge transfer can be done through in-house training and also regular meetings conducted by the Company. This empowerment is what should be used by pharmaceutical companies to improve the competence of its employees.

Meanwhile, the employee of the pharmaceutical company that specifically deals with drug is pharmacist. Surely HC empowerment should also be made for company's pharmacists. This is because the pharmacists who plays an important role in maintaining the quality of products made by the pharmaceutical companies. Indeed, this pharmacist once every five years must renew their competence to collect some credit points that must be met. Such statement was delivered by the informant M:

"So usually like this. These pharmacists in every five years must renew their competence. Well they were first had to go through a competency test, later in the five years they had to collect 60 credits. If they can not collect it then they should follow the competency test again. So from that, the pharmacist should be actively attended seminars. So there is a two points, there is a four points so we should follow and we collect, within five years shall be collected at least 60 points "(*excerpt of an interview with M*)

By constantly updating its competence, it is expected that knowledge, skills, and attitude owned by pharmacists can make pharmaceutical product quality maintained.

Empowerment is not only done on the components of HC, but also about SC owned by pharmaceutical companies. Empowerment can be done by always improving technology, culture, and organizational structure in order to provide an opportunity to constantly innovate and develop ideas on reform. Innovation in the pharmaceutical company has always been at the different department that is research and development department.

Technology has become an important part in the SC empowerment in the pharmaceutical company. This is certainly by the quality of medicines that will be generated. For the development of technological innovation, there are required as required in CPOB or innovation on the company's own desires. DS informant gives an example of rejuvenation machine to be done to meet CPOB standards. As DS informant following statement:

"That's right sir, there must be rejuvenation. For example, the washer bottle pack. First, the wash bottle, the water can be circulated. If the bottle is already on the tube so, it is quite said to be washed like it has been circulated. Now, that the new rules prohibit it. Once used to wash the bottle then the water should be discarded. Well from there then

we should replace the old machines we owned with a new ones according to the rules set by the government "(excerpt of an interview with DS)

Innovation for the development of machinery, equipment, and technology can be caused by the presence of CPOB regulations and also from within the company itself. Innovation of the company can be done on the basis of a top down and bottom up. Top-down approach is usually associated with new machines from overseas suppliers, while that bottom-up usually at the level of production and also in the relationship or marketing. Source of marketing is usually because it is based on customer needs in the market.

Empowerment can be done to the technology, machinery, and equipment is to accept product orders from other companies or by the product term "tolling". It can also be used to help improve the financial performance of the company. As M informant following statement:

"Yes, it could be like that *Sir*. So if for the product itself has been completed, the machine still idling he should receive it "tolling" product. And it can indeed help improve the financial performance. So, to add income, so others should not have to buy the machine again "(excerpt of an interview with M)

SC Empowerment including the aspects of organizational culture. That is, companies began entering or perform the steps in the innovation management has had to change the organizational culture into a culture that is able to absorb and empower creative ideas and innovative employees. To be able to build a culture of innovation, all employees must be able to exchange thoughts and ideas can come from employees.

Empowerment is not only done for HC and SC only, but also to be done on the RC component on innovation management stage. At this stage the RC components are already grow even more than on the knowledge management stage. Empowerment to do at this stage is the use of media or marketing campaign that has begun to be developed by improving relationships with doctors, change the mindset of sales oriented to marketing oriented should have started on the long-term interests. Feedback from customers also have started to be considered and addressed to then performed on a product-related innovation. The use of IT should also have been started for mass marketing. Likewise, the CSR activities have started to do for the community.

The use of appropriate media campaign has become one of the important parts in innovation management stage for OTC products. Similarly, that at this stage the company also has had to begin responds the market needs or complaints as well. For example, if there are complaints on product packaging, it should be quickly addressed by the company for then is performed an innovation on the product. Change of mindset or thinking of sales oriented towards marketing oriented should also be carried out by the company at this stage of innovation management. Company should have a long-term mindset that will have an impact on company performance. By doing marketing oriented so RC empowering will be easier to achieve because of the effort to do branding on the product has begun to appear on the innovation management stage. The use of IT as a medium for promotion and market mediation is also an important part at this stage, including the delivery of sustainable CSR also has to be considered for long-term interests.

Based on the above results, the characteristics and the empowerment of the IC on the stage of innovation management are as follows:

1. The outside company's consultants have started to be used to obtain the innovation process. Source innovation from outside the company apart from the consultant also through marketing team.
2. Innovation and creative ideas have started to grow from within the company, from the employees. That is, a culture of innovation and creative ideas has started to grow at this stage.
3. Innovation of the new or reformulated products has been developed in the research and development department. That is, companies have started using the research and development department to innovate on pharmaceutical products
4. HC Empowerment which can be done is training to grow and develop ideas, creativity, and innovation so it is rising to new ways, new more innovative work systems, and other creative aspects. To that end, the training should be focused on aspects of skill, attitude, and

knowledge. Knowledge empowerment can be done with knowledge sharing between senior employees with juniors, and between experienced employees with new employees. Increasing the number and competence of pharmacists also become the part of the HC empowerment.

5. SC Empowerment which can be done is to empower technology owned and optimize it. Technology or machinery may also be empowered to accept orders from other companies, known as "tolling" products. In addition, cultural empowerment organization towards innovative and creative culture, empowerment of research and development department is also important to do.
6. RC Empowerment which can be done is to use the mass media for optimum imaging products and companies. Strengthening the marketing team to capture innovation in the market to be brought into the company. Empowerment of customer feedback for improvement or product innovation. Empowerment through CSR that is sustainable for the long term.

Based on these characteristics, at this stage the HC empowerment which can be done is training to cultivate and develop ideas, creativity, and innovation giving rise to new ways, new more innovative work systems, and other creative aspects. To that end, the training should be focused on aspects of skill, attitude, and knowledge. Knowledge empowerment can be done with knowledge sharing between senior employees with juniors, and between experienced employees with new employees. Increasing the number and competence of pharmacists also become a part of the HC empowerment. Meanwhile, SC empowerment which can be done is to empower the technology and infrastructure owned by optimizing it. Technology or machinery may also be empowered to accept orders from other companies, known as "tolling" products. In addition, cultural organization empowerment towards innovative and creative culture, empowerment of research and development department is also important to do. RC empowerment which can be done is to use the mass media for optimum imaging products and companies. Strengthen the marketing team to capture innovation in the market to be brought into the company. There is customer feedback empowerment to get improvement or product innovation. RC empowerment at this stage is done through CSR that are still tentative.

Based on the above, and also based on the text's meaning purposes of innovation management stages, the pharmaceutical companies in this stage has begun to find the resources so that innovation can begin to create new ways and new products faster. Pharmaceutical companies in this stage have started out from the internal management problems. That is, internal management is well defined so it can begin to move "out" and do new ways more innovative and creative. Source of pharmaceutical companies innovation is more from marketing team who saw the market and also of the employees. All component of IC namely HC, SC and RC supports the creation efforts for innovation and creativity. HC has begun to develop and empower all knowledge, experience, and skills they have to create new things and new creations. SC also support the creation of innovation to start the growth of a culture of innovation and provide ample opportunity to HC for innovation and creativity. Systems and procedures also provide an opportunity for employees to dare to try new things for the sake of being created new ways more innovative and faster. Likewise, the RC has begun to be able to capture the desires and changes in markets including consumer behavior so as to provide input to management innovation company.

### **B.3. IC Empowerment in Intellectual Property Management Stage**

The purpose of the stages of intellectual property management is to be able to use the intellectual property to improve the competitive position of the organization and earn revenue. When described, there are some key words of the purpose of this stage that is using the intellectual property, improve the competitive position of the organization, and earn revenue. The meaning of "use intellectual property" is the company has to have intellectual property, for example the famous products (branded), images of good companies, have patents, trademarks, copyrights, and high competence and experienced employees. Meanwhile, the meaning of "improving the competitive position of the organization" means the company has a position and will strive to improve its position to the upper level and are also ready to compete with other companies in the same industry at the national level, regional asia, and also international.

Accordingly, the meaning of "earn" is a result of the efforts of a sustained effort by the company to improve and leverage its intellectual property.

At the time of the FGD, also discussed about the characteristics of the pharmaceutical companies in the stages of intellectual property management. By identifying these characteristics it will facilitate the identification of empowerment that must be done in order to optimize the company's IC. Some of the opinion of the FGD participants that the characteristic of the company in the intellectual property management stage is the process of selective recruitment of employees, their competency based human resource management, planning career system, efforts to continue to create brand company and brand product, a good relationship with doctors grade A, and the presence of a great marketing team. At this stage also that the company is able to work together with various parties, including the pharmaceutical companies overseas, human resources management has been doing competency-based human resource management, product innovation has led to the conglomeration in the health business from upstream to downstream, and no longer focus on drug-products.

Based on these characteristics, the empowerment of the IC can be done by pharmaceutical companies in the stages of intellectual property management. HC empowerment at the beginning of the process is when the employee recruitment process as this will affect the next employee development process. If the input is good, it will be easier to develop employees in accordance with the wishes of the company. This is because at this stage, the role of HC should really required to create, develop, and use intellectual property owned to increase the competitiveness of companies. Accordingly, the HC standard on pharmaceutical companies above this level should be really experienced in his field and also has a very good competence. This is certainly in accordance with human resource management competency that has been applied to several major pharmaceutical companies. Similarly, the process of further development of human resources. In the process, it should have a healthy company should be able to plan in career planning system. That all was well planned over each position forward. In this regard, the KK informant give its opinion:

"Ideally, the company is healthy if he never recruit certain positions from the outside. All has been planned through career planning. So that the HR director should know that this position will be retired and the level below will be ready to replace it. And need not be held rolling, the point that the employee knows that the work in this section is like this, if the QC section works like this. So he knows or has a lot of skill or multi-skill. Oh, it is turns out that the A is not suitable in this section but fit in the other sections and developing well. Then he will be forced there and plotted there. Until the highest in the section retired or resigned because there was an offer from another company, we are not confused. So it is that we prepare sir "(Opinion of KK when FGD)

Although there should be a career planning system for HC owned by pharmaceutical companies, it is possible that the quality HC taken from other pharmaceutical companies. This was used to power marketing in the pharmaceutical company. That's what the company strategy in order to achieve intellectual property.

HC Empowerment can also be done by empowering employees' brainware. That is, the company should be able to develop the ability of the brain that is owned by the employees. The results of training, education, and knowledge sharing has been done by the company should be able to be synergy in producing works or new findings both for the system work better, new ways, or innovative products. Thus, an attempt to capture and utilize intellectual property company can be done more easily.

Well, brainware empowerment becomes very important, not least with brain ware owned by marketing personnel. As a reference, the pharmaceutical company marketing personnel Foreign Investment Company (PMA) can be a very good example for HC in intellectual property management stage. This is due to product knowledge owned PMA pharmaceutical company med rep is very nice. They were able to explain much detail as possible, sometimes there is also a doctor who became MR in PMA pharmaceutical company.

HC Empowerment component can also be performed on the pharmacist to maintain product quality. As statements of M informant, which is also a board of GP of Indonesia Pharmaceutical that pharmacists of large pharmaceutical companies can achieve a number

of more than 100 people. With the increasing number of pharmacists in the pharmaceutical companies would be better ensure product quality. The following statement M informant:

"So in the pharmaceutical industry, many pharmacists are absorbed. If it is for a large company it may be up to 100 pharmacists as Dexa Medica group with it may be 100 pharmacists who are there "(*quotation of an interview with M*)

Empowerment at the stage of intellectual property management is not just for the HC components, but applied also to the SC. In the SC component is related to the branded products, patent products, and also the products sold in the market or required by society. Empowerment should be done by pharmaceutical companies to all intellectual property owned through its products. For example, empowerment for ethical products off patent is to convince doctors that the product off this patent has the same benefits to the patent product. This is to be done by pharmaceutical companies if they have a product off patent of leader product. Empowerment on products that have branded this can be via an IP portfolio. For a pharmaceutical company that produces me too on the leader product, empowerment is to convince doctors that its product has the same benefits to the leader product for me too product.

Another SC Empowerment component in the intellectual property management stage is to build and empower its data base system. The system's data base must complete all of the information related to the drug when it is produced and also when marketed and sold. Data base system is certainly very important as database support system that will be very useful for management decision making pharmaceutical companies. In so doing, pharmaceutical companies should be able to build a database system that can be used to manage intellectual property (intellectual property).

Another SC Empowerment components are also corporate culture must change and empowerment at this intellectual property management stage. The corporate culture must change to the professional culture. Empowerment professional corporate culture should be performed on all aspects of each company's activities. The corporate culture that built and empowered to all employees will be the difference between a company that one with another company. This is particularly noticeable when in the "field" to a med rep between the domestic and foreign, including in terms of its facilities.

Build and empower all matters related to the company's activities, such as building a data base system, maintain the quality of products, establishing a culture of professionalism is needed commitment and consistency of the vision and mission of the company which has been formulated previously. This is important because it is related to how the company and all its components can achieve the vision and mission. The steps that have been agreed from the beginning must be implemented in order to achieve the vision of the mission. Commitment and consistency of vision and mission is what should continue to be built and empowered in order to manage management. Several major pharmaceutical companies have implemented the balanced scorecard to map the company's strategy to do with the vision and mission of the target company. The result was remarkable, that there is a significant improvement in the performance of the company.

Empowerment on RC components should also be made at intellectual property management stage. Companies that already at this stage must be able to build and empower the use of information technology (IT) to support all the activities of the company's operations, including in terms of marketing. Performance of pharmaceutical companies including the use of information technology will greatly affect trust the other party, such as a doctor. This relates to the company's brand associated with doctors for marketing ethical products. In the pharmaceutical industry in Indonesia is also a division of grade A, B, C, and D for each company. The company's reputation greatly affect the confidence of others, including foreign investment company that is definitely highly trusted by doctors.

The company's reputation can also be built with different management strategies with other companies. One such strategy is the blue ocean strategy. The essence of the strategy is a strategy to conquer competitors by offering products or services that are not offered by other companies or also make a product or service that does not exist on the market. This is one way that should be built by pharmaceutical companies in the stages of intellectual property management. If pharmaceutical companies in developing and empowering this



strategy, it will be easier to improve the competitive position of the company, and earn as goal of intellectual property management stage. Some pharmaceutical companies are already applying the blue ocean strategy that increases performance. Another strategy is to be built and empowered the branding strategy and branding awareness. Although the strategy is very expensive, in the long run will be very useful and generating high revenues for the pharmaceutical companies.

RC Empowerment for OTC products is to utilize promotional media either print or electronic media. Advertising expenditure reached a great value to be able to achieve the desired return. That is, that the selection of advertising media and also the brand ambassador should be able to lift the OTC product into a product that is easily remembered and appreciated by the public. Giving a drug name that is easy to remember is also important that the products sold in the community.

RC empowerment can also be done in cooperation that has been done by pharmaceutical companies. Cooperation can be done by various parties, at home and abroad. Various interests can be achieved in a variety of such cooperation. For example, cooperation with foreign pharmaceutical companies have patented drug product. Indonesian pharmaceutical company can become a licensee or distributor to market the product patent.

Other RC Empowerment is the aspect of CSR activities undertaken by pharmaceutical companies. CSR conducted by pharmaceutical companies consisting of two events, the event for the purpose of short-term and long-term. Short-term CSR Event for example is working with schools, neighborhood health center, health center for free drug delivery activities, and similar activities. long-term CSR events is more on the formation activities of pharmaceutical company's brand image in order to get the name of the public good, such as cooperation for the award on the best research in the field of pharmacy. CSR activities have to be empowered so as to improve the reputation of pharmaceutical companies for short-term and long-term so that the sustainability the company is maintained.

Based on the above results, the characteristics and the empowerment of the IC on the stages of intellectual property management are as follows:

1. Several big pharmaceutical companies have implemented competency based human resource management and their career planning system. This means that HC management has done well.
2. The company already has a good information technology for the production and marketing databases.
3. good relationship with doctor grade A or doctor leader has been established. This is certainly very beneficial for ethical products of the company because it will be easier to market pharmaceutical products
4. The company has a marketing team and a team of qualified sales force. This is related to how the marketing team was building a good relationship with doctors and KPDM in the hospital.
5. The nominal amount of advertising spending is already very large, by making use of a wide variety of media. CSR activities has been carried out on an ongoing basis. Various forms of cooperation have been carried out by various parties, both inside and outside the country.
6. Empowerment of HC to be done on competency-based human resource management and career planning system that HC can really deliver the best work for pharmaceutical companies.
7. Empowerment of employee brainware, especially in the marketing needs to be done in order to spearhead the sales and marketing of pharmaceutical companies are marketing and also med rep. Likewise, the empowerment to pharmacist can be improved in terms of quantity and quality.
8. SC Empowerment can be done by optimizing the role of branded products, product leader, the product off the famous patent owned by the company. Empowerment can be done with the IP portfolio. Another empowerment in the SC can be done on information technology, machinery, equipment, and also systems that are integrated data base or also electronic data processing (EDP) of the company. Empowerment also be done on corporate culture towards a professional culture. Likewise, the empowerment of vision, mission and strategy through various means of evaluation, for example with a balanced scorecard.

9. RC Empowerment can be done to maximize the company's reputation to convince doctors to ethical products. Empowerment OTC products can be done by optimizing the role of the mass media, CSR activities. Various cooperation can be empowered to various corporate interests.

Based on these characteristics, that at this stage, the empowerment of HC can be done by constantly developing career planning system that has been owned by the pharmaceutical company. If necessary employees (HC) from outside the company, of course, quality, competence, and experience were recruited to be really on top of the average employee in the company. In addition, pharmaceutical companies always improve and develop the knowledge, skills, and brain ware owned by each employee of the company. Meanwhile, the empowerment of the SC can be done by always strive to create a leader in product, brand product, and reputation of pharmaceutical companies. If the resulting product is a product leader but off patent, should try to convince the doctor that the off product is the same benefits of this patent with patent products. The use of information technology to support the operational activities of the company is also a part that should be empowered. Empowerment should also be made to the organizational culture towards a culture of professional organizations including the commitment and consistency to run the company's vision and mission that has been announced previously. RC empowerment can be done by continuing to strengthen the quality of the marketing team and sales force team, strengthen relationships with doctor leaders or the grade A, imaging through the mass media, and perform ongoing CSR.

Based on the above, and also based on the text's meaning purposes of intellectual property management stages, that the pharmaceutical companies in this stage already have intellectual property, such as brand products have started to emerge, the brand image of the company is also well known, including the leader of the company's product. The existence of such a variety of intellectual property, pharmaceutical companies are able to obtain income (superior profit) and also capable of improving the competitive position of the company. At this stage, intellectual property owned by pharmaceutical company is not only associated with the drug alone, but already on other aspects. This means that pharmaceutical companies have a lot to diversify the product or also have a lot of business conglomerates. Diversification of medicinal products is to make the products immunity, dairy, food and beverage supplements, health drinks. The point is products that support health. Business conglomerate of pharmaceutical companies with other businesses that still have relation with the pharmacy and medicine, for example, create a pharmacy, make health clinic. In fact, there are also efforts to conduct pharmaceutical business conglomerate from upstream to downstream, for example by building manufacturer or packer medicine bag, infusion tube, capsule bag, and other pharmaceutical preparations. Pharmaceutical companies already have the intellectual property will be easier to compete and earn revenue. Leader branded product or a product which is very beneficial for the pharmaceutical companies because the existing products more easily remembered by the people, for example when a headache, people will always remember Bodrex or Oskadon. Brand image of the company also greatly affects people's perceptions, such Kalbe Farma products must be good, pharmacies of Kimia Farma definitely complete. Things like this is called intellectual property or intellectual property.

### **C. IC Research with Interpretive Accounting Research**

This IC research is designed with interpretive accounting research as been done by Hermawan (2013). This is done because the purpose of this research is to explore the IC empowerment through CICM. Thus the approach to research carried out in accordance with the purpose of the research is qualitative interpretive research. Indeed, as well as Herman (2013) stated that IC research can be classified into two major groups namely the IC research of financial and non-financial. Financial IC research more widely used to assess the financial performance of the company while non-financial IC research more widely used to build or explore the hidden assets for enhanced performance, competitiveness, and prosperity of the company (Herman, 2012, 2013, 2014). This division eventually also occur on the research method used. For financial IC research using quantitative research

approaches while non financial IC research using qualitative research approaches including this IAR.

IAR contribution of this research is to know the average position of the pharmaceutical companies in Indonesia in general when viewed from the CICM. The result is the average pharmaceutical company in Indonesia is still at the stage of knowledge management and innovation management. Only a few pharmaceutical companies only exist at the stage of intellectual property management. The results of the research is very likely to be obtained by IAR because researchers conducted in-depth interviews and focus group discussions.

The next contribution of IAR in this research is by obtaining the characteristics of the pharmaceutical companies that are at every stage of the IC, which includes knowledge management, innovation management, and intellectual property management. These characteristics inherent in pharmaceutical companies in accordance with the concept of CICM (Al, Ali, 2003). For example, the characteristics of HC on stage pharmaceutical company in knowledge management is still limited funding and therefore contributes to the development of HC. Similarly, the example of the characteristics of pharmaceutical companies on stage innovation management in the empowerment SC, namely innovation and creative ideas have started to grow from within the company. Similarly, examples of the characteristics of the stages of empowerment RC intellectual property management that several major pharmaceutical companies are already implementing competency-based human resource management and their career planning system. Examples of this IC empowerment characteristics can only be done with IAR. Because according Kong and Ramia (2010), non-financial IC research like this that explores the hidden assets, tacit, non-verbal dimension requires in-depth interviews and also the interpretation of the meaning of the key informant.

IAR in more specific research on interpretive research (IR) in management accounting (Lukka and Modell, 2010). The relation of IR management accounting with this research is that this research successfully explores the non-financial activities in the form of the characteristics of companies in the empowerment of the IC at every stage of CICM that this research is able to produce solutions to improve business performance at every stage of knowledge management, innovation management, and intellectual property management. As Herman (2011b) noted that the correlation IC with management accounting practices lies in the non-financial activities and provide useful information for companies to identify hidden assets, measure, communicate the value trigger that is expected to benefit the development of information systems performance measurement and resource allocation in the company.

## **5. Conclusion**

IC Empowerment can be done by CICM through three stages, namely knowledge management, innovation management, and intellectual property management. IC Empowerment through CICM perceived by informants is complete because it starts from the lowest stage to the top stage that is intellectual property management. IC research has produced findings that the average pharmaceutical company in Indonesia is still in the stage of knowledge management and innovation management. Only a few pharmaceutical companies are already at the stage of intellectual property management. When depicted as a triangle, it is divided into three parts. The bottom, and most are pharmaceutical company on knowledge management stage. The middle section is a pharmaceutical company at the innovation management stage. The number of companies at this stage are not as many as the companies at the knowledge management stage. The top part of the triangle must be have little number than two parts below. This section is a pharmaceutical company that is at the intellectual property management stage. Another finding of this research is that empowerment can be performed on all components of the IC (human capital, structural capital and relational capital) and also at all levels CICM (knowledge management, innovation management, and intellectual property management). IC empowerment can be done at all stages of CICM and at all IC components by observing the characteristics of the pharmaceutical companies in each of these stages. Meanwhile, non-financial IC research like this is very possible to be implemented with IAR because they have to understand the meaning of the key informants. Moreover, this IC research should explore the hidden assets and non-financial activities that can be on the measurement of performance, company resource allocation, performance, and also competitiveness.

## References

- Al-Ali, N. (2003). *Comprehensive Intellectual Capital Management*. John Wiley & Sons, Inc., Hoboken, New Jersey.
- Barney, J. (1991). Firm Resources and Sustained Competitive Advantage. *Journal of Management* (17): 99–120.
- Belkaoui, A. R. (2003). Intellectual Capital and Firm Performance US Firm. A Research of The Resource Based and Stakeholders View. *Journal of Intellectual Capital* 4(2): 215-226.
- Bontis, N., W. C. C. Keow, dan S. Richardson. (2000). Intellectual Capital and Business Performance in Malaysian Industries. *Journal of Intellectual Capital* 1(1): 85-100.
- Brooking, Annie. (1997). *Intellectual Capital*. London : International Thompson Business Press.
- Collier, P. M. (2003). *Accounting for Managers: Interpreting Accounting Information For Decision-Making*. West Sussex: John Wiley & Sons.
- De Castro, GM., M D Verde., P L Saez., and J E N Lopez. (2011). Towards “An Intellectual Capital – Based View of The Firm” : Origin and Nature. *Journal Business and Ethics*. (98) : 649 – 662.
- Edvinsson, L., and M. Malone. (1997). *Intellectual Capital : Realizing Your Company's True Value by Finding Its Hidden Brainpower*. NewYork : Harper Collins Publishers Inc.
- Hermawan, S. (2011a). The Integration of Intellectual Capital and Knowledge Management to Improve the Business Performance and Achieve the Competitive Advantage. *Proceeding International Seminar 22 August*. Faculty of Economic and Business. Hasanuddin University. Makassar Indonesia.
- \_\_\_\_\_. (2011b). Praktik Akuntansi Manajemen dan Kinerja Bisnis; Tinjauan Persepektif Intellectual Capital. *Jurnal OPTIMAL FE Universitas Islam “45” Bekasi* 5(2): 179-193.
- \_\_\_\_\_. (2012). Peran, Pengelolaan, dan Pemberdayaan Intellectual Capital Serta Perbaikan Praktik Bisnis Industri Farmasi. *Disertasi*. Faculty of Economics and Business. Airlangga University Surabaya.
- \_\_\_\_\_. W. Hariyanto., H. Ernandi., S. Iswati, dan Z. Fanani. (2012). Model Pengelolaan dan Pengembangan Intellectual Capital Guna Meningkatkan Kinerja Bisnis Industri Farmasi dan Meraih Keunggulan Bersaing Tingkat Global. *Character Grants Research Report of DP2M DIKTI of Ministry of Education and Culture*.
- \_\_\_\_\_. (2013). Makna Intellectual Capital Perspektif The Role Theory dan The Resource Based Theory. *Equity: Journal of Accounting and Finance*, 17 (2), 256 - 275.
- \_\_\_\_\_. (2014). The Concept of Integration of Intellectual Capital and Knowledge Management And Its Relationship With Business Performance. *Proceeding*. International Conference on Entrepreneurship and Business Management (ICEBM) 2014. Penang Malaysia.
- Hsu, Y.H., and W. Fang. (2009). Intellectual Capital and New Product Development Performance : The Mediating Role of Organizational Learning Capability. *Technological Forecasting and Social Change*. (76) 5, 664 – 677.
- International Federation of Accountants (IFAC). (1998). *The Measurement and Management Of Intellectual Capital: An Introduction*. New York. USA.
- Kong, E. (2010). Intellectual Capital Management Enablers : A Structural Equation Modeling Analysis. *Journal Business of Ethics*. 93 (3), 371 – 393.
- \_\_\_\_\_. dan G. Ramia. (2010). A Qualitative Analysis of Intellectual Capital in Social Service Non Profit Organizations: A Theory–Practice Divide. *Journal of Management and Organization* 16(5): 656-676.
- Lukka, K., dan S. Modell. (2010). Validation in Interpretive Management Accounting Research. *Accounting, Organizations and Society* 35: 462-477.
- Marr, B. (2008). Make The Invisible Visible: Identify Intellectual Capital. <http://www.cimaglobal.com>. Diakses 23 Maret 2010. Jam 01.58 WIB.
- Sampoerno, (2007). Kapabilitas Teknologi dan Penguatan R & D: Tantangan Industri Farmasi Indonesia. *Indonesian Pharmaceutical Magazine* 18(4): 199–209.
- Senton, A. K. (2004). Strategies for Ensuring Trustworthiness in Qualitative Research Project. *Education for Information* 22: 63-75.
- Strauss, A., dan J. Corbin. (2003). *Dasar-Dasar Penelitian Kualitatif*. Penerbit Pustaka Pelajar. Yogyakarta.
- Sveiby, K-E. (2001). A Knowledge Based Theory of The Firm to Guide Strategy Formulation. *Journal of Intellectual Capital*. Vol 2 No. 4. *Journal of Intellectual Capital Highly Commended Paper Award for 2001*. Internet version

Wernerfelt, B. (1984). A Resource Based View of the Firm. *Strategic Management Journal* (5) :  
171-180.

# Factors Influence Customers' Loyalty of Unilever Skin Care Product for Indonesian Market

<sup>1</sup>Thai Thi Diem Trang, <sup>2</sup>Filda Rahmiati

<sup>1</sup>Ho Chi Minh City Vietnam, thaitrang2112@gmail.com, +84932039998

<sup>2</sup>Cikarang Indonesia, filda.rahmiati@gmail.com, +6285319093803

## Abstract.

The aim of this study is to identify what are the factors influence of customers' loyalty of Unilever product, especially for Indonesia market that is Citra Skin Care Product. Adapting antecedents of customer loyalty model by Boora and Singh (2011) for appropriateness of skin care goods sector, the study ascertained four main factors influencing customer loyalty which are satisfaction, trust, communication, and commitment. The population of this study is targeted to women in Cikarang area and targeted to 100 respondents who are users of Citra Skin Care. Further, this research use quantitative method and construct questionnaire to get primary data to be used for analysis. The data analysis used are descriptive analysis, validity and reliability, for testing hypothesis classical assumptions used followed by multiple regression analysis, t-test and f-test, and lastly coefficient of determination. The result of this study shows that satisfaction, trust and commitment have positive significant impact toward customer loyalty. As a recommendation, Citra focus more on marketing strategy and product design, innovation and add more value to their product to incentivize the customer to be loyal to the product.

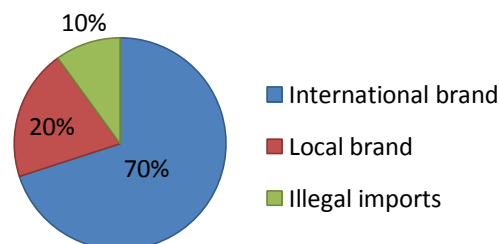
**Keywords:** *satisfaction, trust, communication, and commitment, customers' loyalty, skin care product.*

## 1 Introduction

### 1.1 Background of the Study

Indonesia is known as the world's fourth country which has the highest population that has rapid economic growth and increasing purchasing power (Global Business Guide Indonesia, 2014). Thus, many investors appreciate that Indonesia is an attractive destination for the cosmetic industry that could continue to have strong growth of 10-15% in the future (Spire, 2013). Satrio Utama, senior brand manager for Pond's forecasted that the skin care market in Indonesia may double in size in the next five years (Jakarta Globe, 2014). According to Nielsen Indonesia in Global Business Guide Indonesia, the total spending on skin care products skyrocketed to Rp. 266 Billion in 2013, compared with only Rp. 114 Billion in last year.

The skin care products industry comprises establishments manufacturing all skin care products such as facial care, body and hand care, depilatories, and sun care products (Lucintel, 2014). There are currently over 700 cosmetics company in Indonesia, and about 180 of them are SMEs. With the characteristics of this cosmetic market, not only domestic companies but multinationals also had been attracted to invest in this market. Although there is intensive competition in beauty care market but many companies still pay attention to invest in this market to respond for the high demand available in market. The article of Spire research and consulting, publish 2013, market share of Skin care product in Indonesia 2012 is shown as follow:



**Figure 1.1:** Market share of Skin care product in Indonesia 2012

*(Source: Spire research and consulting, 2013)*

From the above pie, it means international brands and imported products will continue to pose a major challenge in the Indonesia cosmetic industry. However, there are a lot of local brands in the global company that can get success in skin care market; the leading player in the Body Care category is PT. Unilever Indonesia with 23% estimate market share (Spire, 2013).

**Table 1.1:** Leading player in the Body Care category

**2012 Estimated Total Market Value: US\$ 611 Million**

Company Name	Known Brands	Est Market Share
PT. Unilever Indonesia	Citra, Lifebuoy, Lux, Pepsodent, Close Up, Vaseline	23%
PT. P&G Indonesia	Olay	19%
PT. Wings Corp	Emeron, Kodomo, Ciptadent, Fluordent, Smile Up, Giv, Priti, Nuvo, Sanex	17%
PT. Johnson & Johnson Indonesia	Listerine, Johnson's	9%
PT. Sara Lee Indonesia	Purol	6%

*(Source: Spire research and consulting, 2013)*

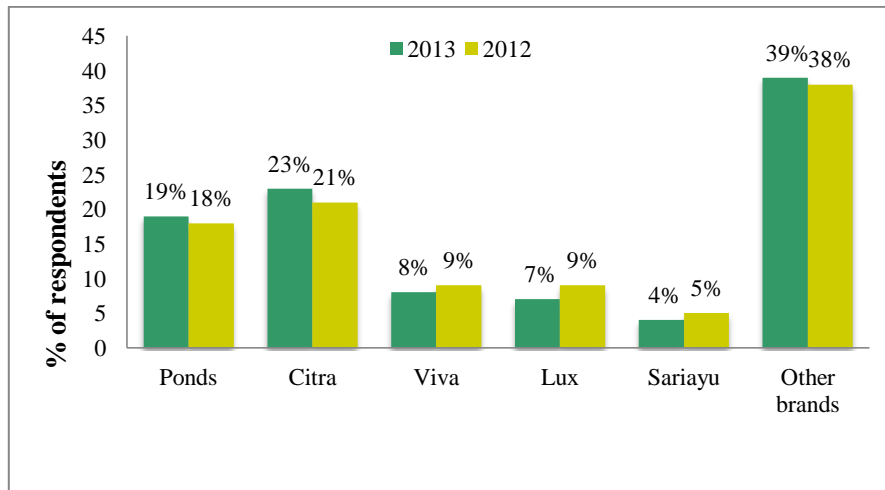
Citra is one of most famous brands of Unilever Indonesia and known as a natural based ingredients beauty brand with strong Indonesian heritage (Unilever, 2014). Thanks to those, going through more than 20 years of development, Citra has maintained its position as the market leader in the Hand & Body Lotion market in Indonesia. Citra provides different kind of products to satisfy customer demand like Hand & Body Lotion, Body Scrub, Soap, Body Wash, Facial Foam, Face Moisturizer. As its vision is to become a total skin brand, Citra seems to keep developing itself, both in its variations and its packages, which evolve from time to time. All of Citra products are made from natural ingredients, such as from bengkoang, green tea, milk, olive oil, and Japanese rice. Citra's continuous commitment to explore the consumer insight and create innovations based on these insights has been rewarded. This can be reflected in the various awards that were given to Citra, among others: Indonesian Best Brand Awards and Indonesian Consumer Satisfaction Award. In the Hand & Body Lotion market, Citra has the highest loyalty index. Based on these findings, Citra was given the Indonesian Consumer Loyalty Awards in 2006. Over the past years, Citra has maintained its position as the market leader in the Hand & Body Lotion market in Indonesia.

Under strongly competitive environment such Indonesia, Citra has to fight stronger than others to protect its first position in the market, in other words, its market share. Therefore, role of loyal customers has become important than ever to Citra because they are obviously key to winning market share race.

## **1.2 Problem Identification**

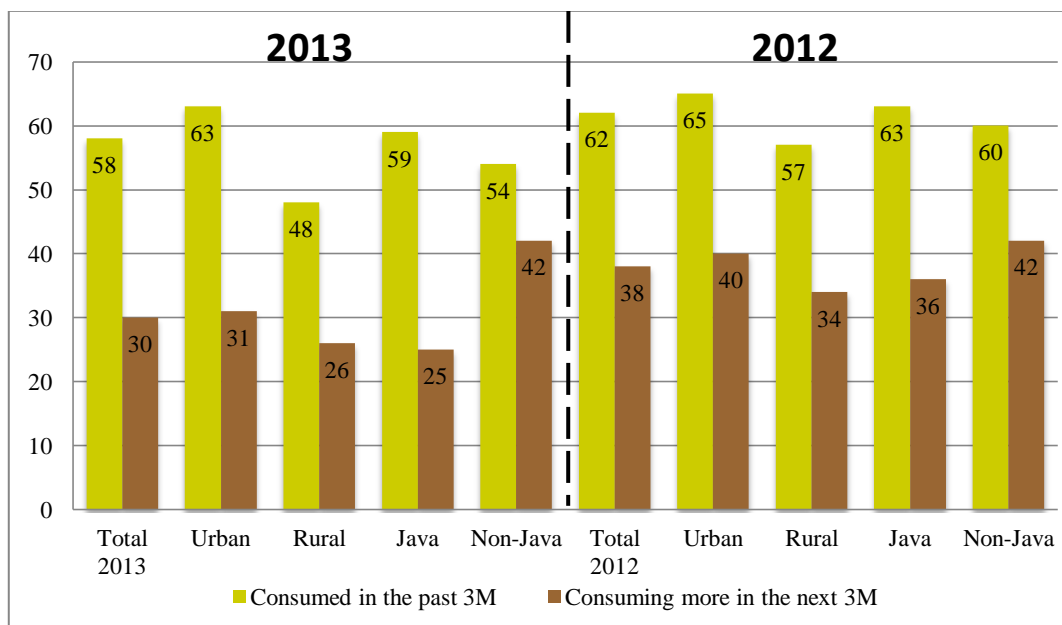
In the Equity Research about Indonesia Consumer Survey 2014, the research analysts, Nusantoro, Tjitra & Naseer conducted analysis on data that was collected from 1,515 consumers in Indonesia across ten exclusive geographies, both urban and rural area. The research showed that Unilever Indonesia is the leading manufacturer with Ponds and Citra in cosmetic & skin care products segment.

By seeing the below figure 1.2, Citra continues to gain popularity in two years (2012 and 2013), with 23% of respondents consuming the brand in this year's survey compared with 21% in the previous year's survey. Citra remain the most popular brand, the brand is mostly popular especially among the younger generation, in the rural area and out Java residents. The consumption of cosmetic and skin care by brand in 2012 and 2013 is as follows:



**Figure 1.2:** Cosmetic & Skin Care consumption by Brand  
 (Source: Credit Suisse Indonesia Consumer Survey, 2014)

However, in cosmetic & skin care segment, Nusantoro, Tjitra & Naseer (2014) also show that the consumption of Indonesian has a decrease in late 2013 and foreseeable it will continue to decline in 2014.



**Figure 1.3:** Cosmetic & Skin Care consumption of Indonesian  
 (Source: Credit Suisse Indonesia Consumer Survey 2014)

Figure above shows 58% of the respondents have consumed them in the last 3 months; it is a lesser respondents compared with the previous year's survey (62%). And only 30% of the respondents want to consume more in the next three months, it was a decline from 38% in the previous year's survey. Hence, it totally affects the brand of Citra which is belonging to cosmetic product category. Thus, how to maintain the leading position of Citra would be a challenge for its management team. In this case, the loyalty of customer plays significant role for Citra product. Thus, the research is going to find out answer to following question: **“What are Factors Influence Customers’ Loyalty Of Unilever Skin Care Product For Indonesian Market ?”**



### **1.3 Statement of the Problems**

- a) Is there any significant partial influence of Satisfaction toward Customer Loyalty of Unilever Skin Care Product for Indonesian Market?
- b) Is there any significant partial influence of Trust toward Customer Loyalty of Unilever Skin Care Product for Indonesian Market?
- c) Is there any significant partial influence of Communication toward Customer Loyalty of Unilever Skin Care Product for Indonesian Market?
- d) Is there any significant partial influence of Commitment toward Customer Loyalty of Unilever Skin Care Product for Indonesian Market?
- e) Is there any significant simultaneous influence of Satisfaction, Trust, Communication, Commitment toward Customer Loyalty of Unilever Skin Care Product for Indonesian Market?

### **1.4 Research Objectives**

- a) To analyze the partially significant influence of Satisfaction toward Customer Loyalty of Unilever Skin Care Product for Indonesian Market.
- b) To analyze the partially significant influence of Trust toward Customer Loyalty of Unilever Skin Care Product for Indonesian Market.
- c) To analyze the partially significant influence of Communication toward Customer Loyalty of Unilever Skin Care Product for Indonesian Market.
- d) To analyze the partially significant influence of Commitment toward Customer Loyalty of Unilever Skin Care Product for Indonesian Market.
- e) To analyze the simultaneously significant influence of satisfaction, trust, communication and commitment toward Customer Loyalty of Unilever Skin Care Product for Indonesian Market.

### **1.5 Research Limitation**

The first limitation of this research is only focus on the four factors: satisfaction, trust, communication, and commitment influence customer loyalty, other factors which are not listed in this research are not observed. The second limitation is consideration of the population of the research. Based on the target consumers of Unilever Skin Care Product which produce specially for Indonesia Market, this research is focusing on Citra's skin care products. The target consumers would be 15-35 years old women who have used the Citra in their daily lives located in Cikarang City as the respondents for the questionnaire survey.

## **2 Literature Review**

### **2.1 Customer Satisfaction**

Customer satisfaction can be defined as "the degree to which a business's product or service performance matches up to the expectation of the customer" (Roberts-Lombard, 2009). Kotler and Armstrong believed that the behavior after purchasing a product or service can cause customer satisfaction and dissatisfaction. Customer satisfaction depends on the product's perceived performance relative to a buyer's expectations. If the product's performance falls short of expectations, the customer is dissatisfied. If performance matches expectations, the customer is satisfied. On the other hand, if performance exceeds expectations, the customer is highly satisfied or delighted (Kotler and Armstrong, 2012). Customer satisfaction is also an essential step in the customer loyalty hierarchy. However, customer satisfaction can be considered as the starting the point of customer loyalty formation but it certainly is not guarantee of customer loyalty (Rai, 2012). Satisfaction is an element which fulfills the need of the customer associated with that product: e.g. Citra's hand & body lotion product is positioned as beauty care product thus can only satisfy the customer if it enhances fairness of the skin of a user. When the customer satisfaction rises, companies' market share will have directly effect, which leads to improved profits, positive recommendation, lower marketing expenditures (Reichheld, 2001).

### **2.2 Trust**

Trust represents faith in partner's openness and truthfulness in business communication (Kumra and Mittal, 2004). Trust involves someone's willingness to act specifically because on believes that the

partner will give what is hoped and wanted, or one's promise or hope will be fulfilled. When customer is trust a product or service, it also shows their ability to be loyal with the company and give favorable positive feedback to them over the competitors. Ranaweera and Prabhu (2003) stated that trust is likely to result in customer retention when it comes to maintaining long term relationship between service provider and customer. The customer trust is not only helpful and beneficial when the company is in good stable mode but also it's a main source for the customers to be in the market and to remain in the market even where there is high level of uncertainty for the company or suppliers in the current market relationship in business without trust a relationship will not retain for long.

### 2.3 Communication

Communication is a process by which formal and informal sharing of meaningful and timely information between seller and buyer. It is as an interactive dialogue between the company and its customers that take place during the pre-selling, selling, consuming and post-consuming stages. Through this dialogue, preference is developed, dissatisfied customer knows what the organization is doing to rectify the source of dissatisfaction (Ndubisi and Chan, 2005). Continuously, under Boora and Singh's point of view in 2011, communication is the ability to provide timely and trustworthy information. Communications in marketing means providing information that can be trusted; marketing communication—through salespeople, advertisements, free samples, or other such methods—can attempt to change what people believe to be true about a product or service (cognitive) or how they feel toward it (affective) (Grewal and Levy, 2014). However, the customer also required honest communication because it is a key to developing successful relationships in marketing. That is the communicator's task; they need to build awareness, develop consumer preference by promoting quality, value, performance and other features, convince interested buyers, and encourage them to make the purchase decision (Ndubisi and Chan, 2005).

### 2.4 Commitment

Commitment can be defined as the sacrifices made by the seller and buyer to maintain a relationship. Motamedifar et al. (2013) also stated that commitment is one of the important variables for understanding the strength of a marketing relationship It is a useful construct for measuring the likelihood of customer loyalty as well as for predicting future purchase frequency and it represents the highest level of relationship bonding. According to Evanschitzky and Wunderlich (2006), there are two different types of commitment: affective and calculative. Affective and calculative commitment have been used in marketing to understand relational exchanges between the buyer and supplier and have been shown to mediated successful long term relationships and future intention of repurchase.

**Table 2.1:** Type of commitment

<b>Affective commitment</b>	<b>Calculative commitment (or continuance commitment)</b>
Affective commitment is characterized by a desire-based attachment of the customer, meaning that the customer is loyal because he or she wants to be loyal	Calculative commitment is the customer's desire to remain in the relationship when the switching costs are high or when the customer perceives that other viable alternatives are scarce

*(Source: Evanschitzky and Wunderlich 2006)*

### 2.5 Customer Loyalty

A definition of loyalty which is frequently appeared in the marketing literatures comes from Oliver "a deeply held commitment to re-buy or re-patronize a preferred product or service consistently in the future, thereby causing repetitive same-brand or same brand-set purchasing, despite situational influences and marketing efforts have the potential to cause switching behavior" (Oliver, 2010). According to Sheth and Mittal (2004), customer loyalty in marketing is the commitment of customers to a brand, shop, or suppliers, based on a very positive attitude and is reflected in the consistent repeat purchases. Cheng (2011) stated that customer loyalty is a customer's sense of identification with a business. This sense of identification affects repurchases intentions, spending amount, the

possibility of recommendation, and even the willingness to become part of a business. Customer loyalty is the result of successful marketing strategy in competitive markets that creates value for consumers. Thus, customer loyalty is considered to be a key factor in order to achieve company success and sustainability over time (Flavián and Guinalú, 2006).

### 2.5.1 Characteristic of Customer Loyalty

Griffin (2005) argued that there are two (2) characteristics of loyal customers as below:

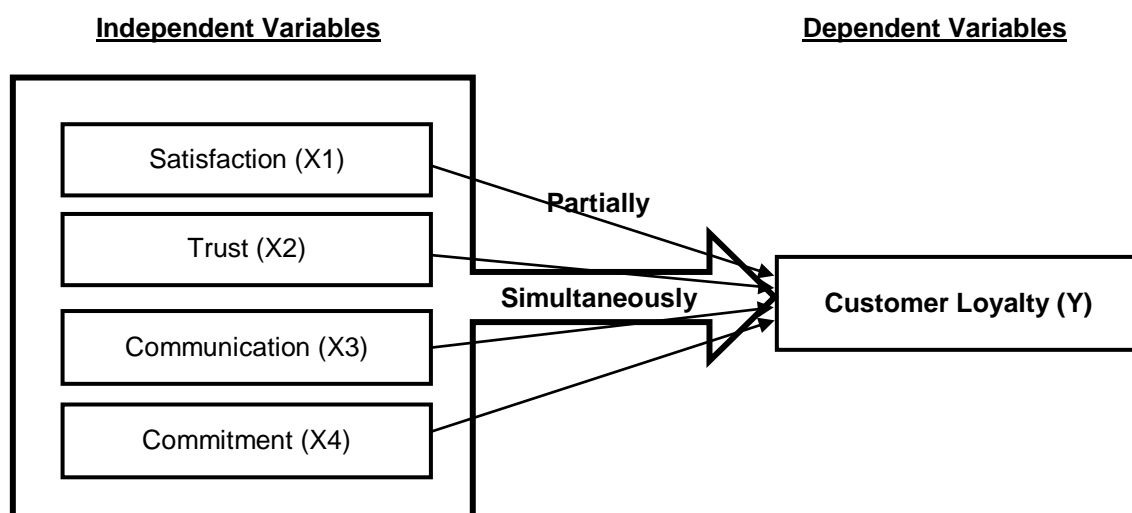
a). Repeat Purchase

the customer have purchased the product more than two times in different occurrence and keep using the brand.

b). Highly committed to the brand

The customer has a strong relationship with the company which has been occurred for a long time. Commitment means the customer is resistance to other brands and stick to one brand only which has given them a value.

### 2.6 Theoretical Framework



(Source: Self-Construct from Boora & Singh, 2011)

### 2.7 Hypothesis

Based on the constructed framework above, the hypothesis of this research are:

H1: There is partially significant influence between satisfaction (X1) towards customer loyalty (Y) of Unilever Skin Care Product for Indonesian Market.

H2: There is partially significant influence between trust (X2) towards customer loyalty (Y) of Unilever Skin Care Product for Indonesian Market.

H3: There is partially significant influence between communication (X3) towards customer loyalty (Y) at Cikarang area, Indonesia.

H4: There is partially significant influence between commitment (X4) towards customer loyalty (Y) of Unilever Skin Care Product for Indonesian Market.

H5: There is simultaneously significant influence between satisfaction, trust, communication and commitment (X1,2,3,4) towards customer loyalty (Y) of Unilever Skin Care Product for Indonesian Market.

### 3 Methodology

#### 3.1 Research Design

Basically, there are two types of methods are used to analysis data that can be appropriately applied with any research study. That is qualitative research method and quantitative research method. In this research, Quantitative Method will be used because the purpose of this research is to analysis factors that influence to customer loyalty toward Citra's skin care product in Indonesia. In order to reach the aims, the large-scale sample is needed and after considering the numerous benefits offered, quantitative research method are seen to be the appropriate and right method to collect the primary data as well as to analyze those obtained data for the study. Quantitative research also shows the relationship between independent variables and the dependent variable. The process of measurement is central to quantitative research because it provides the fundamental connection between empirical observation and mathematical expression of quantitative relationships (Render, Stair and Hanna, 2006).

#### 3.2 Sampling Design

Sampling method or sampling design is the other important step in doing a research. "A sample examines a portion of a target population, and the portion must be carefully selected to represent that population. Researchers has to determine which and how many people to interview, which and how many events to observe, or which and how many records to inspect" (Cooper and Schindler, 2011). If a sampling is done correctly, statistical analysis can be used to generalize a whole population.

##### 3.2.1 Population

A population is the total collection of elements about which we wish to make some inferences (Cooper and Schindler, 2011). A population element is the individual participant or object on which the measurement is taken. The research was conducted in Cikarang, West Java, Indonesia. Based on the target of Unilever Product for Indonesia Market that is specifically Citra skin care products, the population for this study is the women customers who have used Citra's skin care product from 15 to more than 35 years old.

##### 3.2.2 Sampling Technique Applied

There are two major types of sampling design: probability and non-probability sampling. Due to this research will conduct quantitative method and need to distribute a questionnaire in other to get the expect information. However, with the large area and huge population in Cikarang city, researchers would be faced the difficult to define the amount of customer who have used Citra's skin care product. According to Zikmund and Babin (2007) non – probability means it chooses unknown particular sample of population. Therefore, in order to collect the data for the study, the researcher used non-probability sampling technique because unknown population of Cikarang area. The method used in this non-probability sampling research was convenience sampling.

##### 3.2.3 Sample Size

Sample size will be selected determine the number of sample (or respondent) which need to survey; this research will use infinite population formula (Black, 2011). The formula as follows:

**Equation 3.1:** Infinite population

$$n = \frac{Z^2 \times p \times (1 - p)}{e^2}$$

*Source: Black, 2011*

Where:            n = number of sample needed  
                      Z = the Z value (1.96 for 95% confidence levels)  
                      p = percentage of population with a particular choice

e = the acceptable sampling error (0.05)

Therefore: Based on the result of pre-test that was collected from 30 respondents, there are 28 persons (93.3%) out of 30 have been used Citra's skin care product and 2 person are never used Citra's product. Hence, researchers used 0.933 as value of p - percentage of population with a particular choice.

The computation is followed:

$$n = \frac{1.96^2 \times 0.933 \times (1 - 0.933)}{0.05^2} = 96.056$$

Based on the above result, researcher got 96.056 for total minimum sample. This means that this research better be taking more than 96 respondents. Finally, the author decided to round up and take 100 samples for this research.

### 3.3 Research Instrument

This research is use primary data. Questionnaires are a technique of data collection done by giving series of written statements that are consists of research variables. Questionnaire provided a means of collecting primary data that was quantified to be used in the analysis process in order to draw conclusions based on the sample.

In this case, the writer using the questionnaire enclosed is questionnaire that presented in a form such that the respondents were asked to choose one answer that suits the characteristics of him by giving the sign (x) or a checklist (√). The questionnaire is only given to the consumer who has experienced with Citra's product due to the validity of the answer. . In this research, the questionnaire is divided into 3 parts. Before coming to the first part, respondents are introduced to the purpose of survey and inform about researcher.

**Part 1:** Participants are asked to show their individual information by answering 3 questions about their age, occupation and monthly income.

**Part 2:** To ensure that the respondents already used the Citra's skin care product, the author built the screening question. There are 3 questions:

- a) Q1. Respondents have used Citra product or not.
- b) Q2. Kind of Citra product that they used.
- c) Q3. The time number buy product in month.

If any customer said that she/he has never used Citra product, it mean they do not need to make the question in third part.

**Part 3:** This is the major part in the research; the level of female perception to Citra skin care products. The related items concern 4 dimensions about factors affecting on customer loyalty: satisfaction, trust, communication, commitment. The final questionnaire has 26 total items. The questions were generated from both the literatures and developed by researchers based on journal and actual situation in Indonesia skin care industry. Table below showed a list of questions in this research:

**Table 3.1:** Questions and source

Variable	Code	Questions	Source
Satisfaction	SAT1	Citra product's quality meets my expectations in term of: the soft skinned after using.	Adapted from (Punniyamoorthy et al., 2011)
	SAT2	Citra product's quality meets my expectations in term of: the brighter skin after using.	
	SAT3	Citra product's quality meets my expectations in term of: lasting scent on the skin after using.	
	SAT4	Citra's product quality has not changed from the new launch.	

	SAT5	Citra's product is worth the money I spent.	
	SAT6	Citra's product is reasonably price. I am satisfied with Citra's product price	
Trust	TRU1	I can say that Citra is always honest and product quality is always ensured as the manufacturer has confirmed.	Adapted from (Punniyamoorthy et al., 2011)
	TRU2	I trust on the information on Citra's product.	
	TRU3	Citra never disappoints me.	
	TRU4	I feel secure when choosing Citra because of the brand itself.	
	TRU5	I believe that Citra is going to develop strongly in long term.	Adapted from Son (2013)
Communication	MUN1	I feel that Citra's advertisement provide me enough information about its product.	Adapted from (Shavitt, Lowrey and Haefner, 1998)
	MUN2	I feel that Citra's advertisement provide me factual/honest information about its product.	
	MUN3	I can update the new line product of Citra through advertisement.	
	MUN4	I can try using new product of Citra through sample delivery.	Adapted from (Lau et al., 2006)
	MUN5	Promotional schemes (extra quantity, buy 1 get 1, price promotion) are important to my decision to keep purchasing with Citra.	Adapted from (Omotayo, 2011)
Commitment	COM1	I have strong preference for Citra product.	Adapted from (Punniyamoorthy et al., 2011)
	COM2	My preference for Citra's brand will not change.	
	COM3	To change my preference from Citra, it required me have to think very carefully.	
	COM4	Even if close friends recommend another brand, I would not change my preference for Citra.	
	COM5	Citra is my only choice when choosing skin care product.	
Customer's Loyalty	LOY1	I consider myself to be loyal to Citra because I feel satisfied	Adapted from (Punniyamoorthy et al., 2011)
	LOY2	Even if another brand has the same features with Citra, I would refer to buy Citra's product.	
	LOY3	I am willing to continue repurchase Citra's product.	
	LOY4	I'll recommend Citra's skin care product to my friends and relatives.	
	LOY5	I'll defend for my choice if there is any negative feedback about Citra.	

(Source: Self-constructed)

To know a category in every class can be use a range scale such in below (Simamora, 2005)  
Based on the range score, so the Class interval can be categorized as follow:

**Table 3.2:** Class interval

Class interval	Description
1.00 – 1.79	Strongly Disagree
1.80 – 2.59	Disagree
2.60 – 3.39	Neither Agree nor Disagree (Neutral)
3.40 – 4.19	Agree
4.20 – 5.00	Strongly Agree

(Source: Self-constructed)

### 3.4 Validity and Reliability

Validity test represents how far the measurement can measure what the researcher wants to measure, are we measure the right thing or not (Cooper and Schindler, 2011). In this research, researchers will use SPSS 20 to calculate and check the validity of the question based on the data of the pilot test.

The first requirement of a good instrument was reliability. The Reliability test of a measure indicates the extent to which it is without bias (error free) and hence ensures consistent measurement across the time and across the various items in the instrument. Accurate questionnaire may deflect the right question which is means when the question is asked for several times, the interpretation would be the same from one respondent to another. Measurement of Reliability (Internal-Consistency) in this research will use the Cronbach's Alpha Coefficient; the equation is (Janzen group.net, 2013). According to Malhotra and Peterson (2010) concluded that to achieve the moderate scale reliability, the alpha value of all items that indicated the reliability statistics has to be criterion of at least 0.60. The Cronbach's value will be calculated by using SPSS 20 software.

### 3.5 Hypothesis Testing

#### 3.5.1 Classical Assumption Test

In order to use the multiple regression models, classical assumption test is need to implement such as normality test, multicollinearity and heteroscedascity test. Normality test is test that is used to determine whether the data is well set-modeled by a normal distribution or not, or to compute how an unlikely random variable is to be normally distribute. Theory driven plot consist of P-P plot (probability-probability plot), in this part researchers will get normal data if the plot is distributed by following the shape of line. The normality test also can be done by using SPSS 20.0 statistical software.

Multicollinearity test is a test that used to know or detect whether any independent variable that correlated strongly to each other in the multiple regression models. Multicollinearity is situation that researcher have to avoid because it will not good for independent variable correlated strongly to each other. In order to measure multicollinearity, variance inflation factor (VIF) is used to measure. Normally, VIF measure how much the variance of the estimated coefficients is increased over the case of no correlation among the X variables. According to Lind, Marchal and Wathen (2012), a VIF greater than 10 is considered unsatisfactory, indicating that the independent variable should be removed from the analysis. When VIF is under 10, it means that there is no multicollinearity problem aroused.

Heteroscedaticity test is used for knowing whether the data is not normally distributed and it also use to know if the variance terms of errors are difference across observations. It can be seen from the scatter plot by looking at distribution of residual value toward the predicted value. If the distribution is spread randomly without any systematic pattern, then the data is passed the heteroscedaticity test.

#### 3.5.2 Multiple Regression Analysis

Mark, David and Timothy (2012), multiple regression models is used for estimating or forecasting the value of variable Y, which calculated using several variables that affect Y. The research on relationship between one dependent variable (Y) with four other independent variables (X<sub>1</sub>, X<sub>2</sub>, X<sub>3</sub>, and X<sub>4</sub>) used to understand the relationship between them. The result from this regression analysis will be used to accept or to reject the hypothesis as to observe whether there is any effect or not between dependent and independent variables. The underlying multiple regressions model will be used:

**Equation 3.2:** Multiple Linear Regression Model

$$Y = \beta_0 + \beta_1 X_1 + \beta_2 X_2 + \beta_3 X_3 + \beta_4 X_4 + e$$

(Source: Mark, David and Timothy 2012)

Where: Y = Customer's Loyalty (Dependent Variable)

$\beta_0$	= Y intercept
$\beta_1 - \beta_4$	= Regression Coefficient
X1	= Satisfaction (Independent Variable)
X2	= Trust (Independent Variable)
X3	= Communication (Independent Variable)
X4	= Commitment (Independent Variable)
e	= Random Error

### 3.5.3 Testing Hypothesis

#### 3.5.3.1 T-Test

The T-Test is applied to determine the partial relationship between each independent variable (coefficient) and the dependent variable. The null hypothesis is that the coefficient of X (i.e., the slope of the line) is 0. If the significance level for the T-Test is low (significance level  $\alpha$  used is 0.05), we reject  $H_0$  and conclude there is a linear relationship, and vice versa (Lind, Marchal and Wathen, 2012).

$$H_0: \beta_1 = 0, \text{ if Significant } T > 0.05, \text{ accept } H_0$$
$$H_a: \beta_1 \neq 0, \text{ if Significant } T < 0.05, \text{ reject } H_0$$

In this research, researchers would use the output from SPSS 20.0 from primary data to analyze for accuracy results.

#### 3.5.3.2 F-Test

The F-Test determines whether or not there is a relationship between set of independent variables and dependent variable simultaneously. And F-Test is used to statistically test the null hypothesis that there is no linear relationship between the X and Y variables (i.e.  $\beta = 0$ ). The level of significance that used in this research is  $\alpha = 0.05$ , if the significance level for the F-Test is low,  $H_0$  is rejected and conclude there is a linear relationship, and vice versa (Lind, Marchal and Wathen, 2012).  $H_0$  is accepted if the F-test value is greater than the level of significance  $\alpha = 0.05$ .

$$H_0: \beta_1 = \beta_2 = \beta_3 = \beta_4 = 0, \text{ if significant } F > 0.05, \text{ accept } H_0$$

$$H_a: \text{at least there is one } \beta \neq 0, \text{ if significant } F < 0.05, \text{ reject } H_0$$

#### 3.5.3.3 The coefficient of determination ( $r^2$ )

In the multiple regression model, the coefficient of multiple determination  $r^2$  represents the proportion of variant in Y that is explained by the independent variables  $X_1$  and  $X_2$  in the multiple regression equation. The coefficient of determination is a summary measure that tells how well the sample regression line fits the data (Mark, David and Timothy, 2012). Statistically, it measures how many percentage variation of Y variable explained by the repressors jointly. The  $r^2$  value can range from a low of 0 to a high 1 ( $0 \leq r^2 \leq 1$ ).

If  $r^2 = 0$ , indicating that X explains 0% of the variability in Y.

If  $r^2 = 1$ , indicating that every point in the sample were on the regression line (meaning all errors are 0).

In the other words, 100% of the variability in Y could be explained by the regression equation. In developing regression equation, a good model will have an  $r^2$  value close to 1. In this research, researchers would use the output from SPSS 20.0 from primary data to analyze for accuracy results.



## 4 Analysis and Interpretation

### 4.1 Data Analysis

The pre-test was implementing on 30 respondents in Cikarang. There is the total of 26 questions in forms of pre-questionnaire statements. The pilot tests conducted were validity test and reliability test and the tool that supports for this test is SPSS 20. This research used the Correlation of Coefficient of Pearson Product Moment to test validity of data. Based on the Critical Values of the Linear Correlation Coefficient table, with  $n=30$  respondents and significant level is 5 per cent, the value of  $r$ -table is 0.361. So, the questions in questionnaire are valid when the  $r$ -computed value of every question that is bigger 0.361.

There are 2 questions with  $r$  value below 0.361. It is clear that those questions did not fulfill the requirement to be valid and need to reject. Hence the remaining 24 questions is valid that will be used further in the analysis of customer loyalty. In this pre-test, the total Cronbach  $\alpha$  value is 0.909 or 90.9 percent ( $N = 26$ ), that means all dependent variables and independent variable that are used in this study are reliable. It also means that all variable above are well correlated to each other and the reliability of all items is acceptable for the research.

### 4.2 Respondent Profile

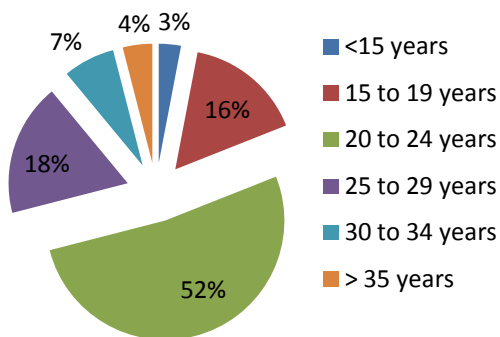


Figure 4.1 Age of Respondents

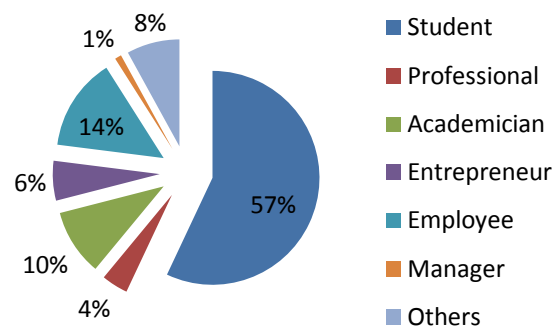


Figure 4.2 Occupation of Respondents

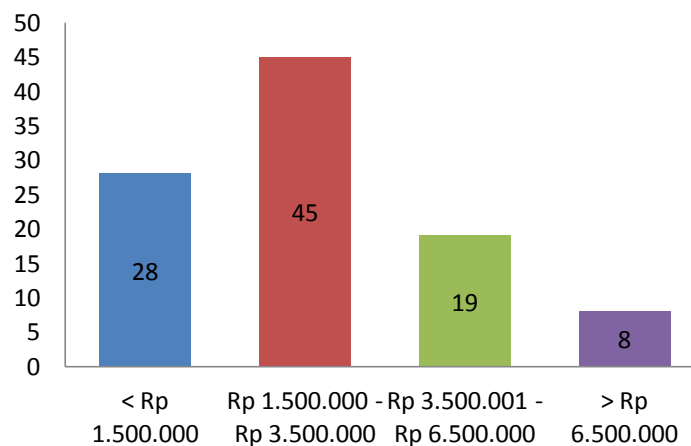


Figure 4.3 Monthly Income of Respondents

Based on figure 4.1 until 4.3 majority of the respondents are in the age between 15 to 29 years old with the occupation is student and having monthly income or expense around Rp. 1,5 million to Rp. 3,5 million.

### 4.3 Characteristic of Respondents based on types of Citra's product

**Table 4.1:** Kind of Citra's products have used

Citra's Product Used by Respondents	Percent
Hand and Body Lotion	48.8%
Body Scrub	11.6%
Body Wash	14.6%
Soap	12.8%
Facial Foam	7.3%
Face Moisturizer	4.9%
Total	100.0%

There are many kinds of Citra products that people can use with different options for themselves. The above table 4.1 showed that Hand and Body Lotion has highest consume with 80 consumers in 100 using Citra. Besides, Body Wash, Soap and Body Scrub products are also consumer's choose, it is rather high compare with Facial Foam and Face Moisturizer products, account for 24, 21 and 19 user, respectively and only 12 people using facial foam & 8 people using face moisturizer.

### 4.4 The Characteristic of Respondents based on age toward repurchase of Citra's product

**Table 4.2** Crosstabulation of Age and Repurchase Frequency

	Repurchase Frequency				Total
	Once/ month	Twice/ month	Once/ 2 months	Once/ 3 months	
<15 years	2	1	0	0	3
15 to 19 years	11	3	2	0	16
20 to 24 years	28	9	8	7	52
25 to 29 years	14	1	0	3	18
30 to 34 years	4	0	2	1	7
> 35 years	1	1	2	0	4
Total	60	15	14	11	100

Based on table 4.2 above, repurchase frequency got highest by respondents with age between 20-24 years old and they usually but the Citra product once a month.

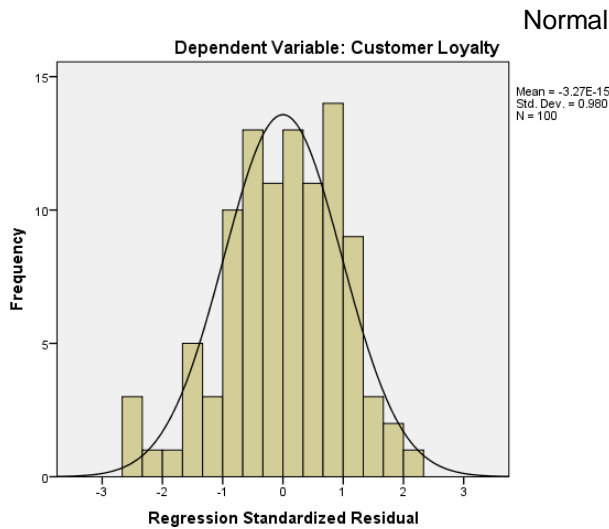
### 4.5 Descriptive Statistic Analysis

**Table 4.3** Descriptive Statistic of All Variables

	N	Mean	Std. Deviation
Satisfaction	100	3.86	0.4954
Trust	100	3.91	0.5204
Communication	100	3.35	0.4516
Commitment	100	3.56	0.6569
Customer Loyalty	100	3.58	0.6056

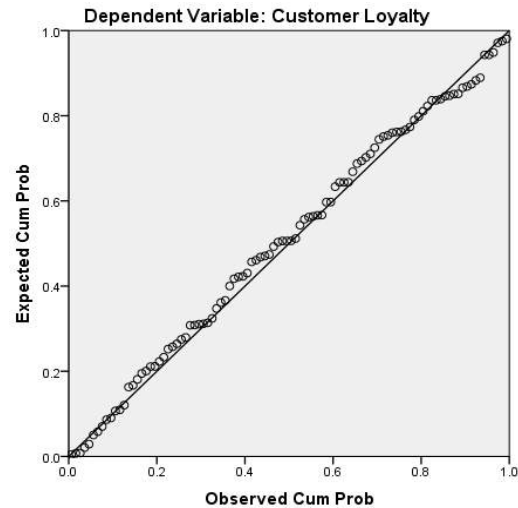
Based on table 4.3 about how respondents respond to the questions based on Likert scare used, the highest mean was based on trust variable which mean score of 3.91, whereas the lowest mean was from Communication variable. This result can be say that respondents are likely to answer agree toward questions in the most all variables except communication. As we can see most of the mean are between 3.40-4.19 which means under range scale of agree if we refer to previous table 3.4.

#### 4.6 Classical Assumption Test Result



**Figure 4.4** Histogram

#### Normality Test

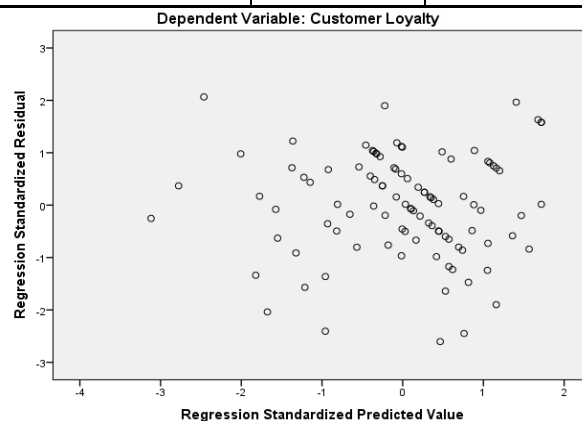


**Figure 4.5** Normal P-P Plot of Regression Standardized Residual

#### Multicollinearity Test

**Table 4.4** Multicollinearity Table

Model	Collinearity Statistics	
	Tolerance	VIF
Satisfaction	.799	1.251
Trust	.795	1.258
Communication	.958	1.043
Commitment	.771	1.296



**Figure 4.6** Scatterplot

The histogram in figure 4.4 shows the curve was formed a proper bell shape in the center of the histogram. Hence researchers can conclude that the data has normally distribution. Besides that, normality test can also be measured by seeing the normal P-P plot of Regression Standardized Residual. Based on the figure 4.5 above, it is clear that the actual data plots (represented by the dots) stay in around the diagonal line and follow the direction of the diagonal line. It means that there is a normality distribution and the data eligible to conduct the research.

According to Render, Stair and Hanna (2006), a variable has high multicollinearity if it has VIF value more than 10 or it has tolerance tend to approach 0. It means that if  $VIF < 10$  and tolerance value  $> 10\%$ , a variable is no multicollinearity. From the table 4.4 above shows that all variables have VIF value less than 10. Thus, in this regressions model there is no multicollienarity exists. Lastly,by seeing the scatterplot in figure 4.6, the plots are spread randomly without creating a certain or systematic pattern such as decreasing or increasing pattern. The plots are spread randomly above and below 0. It means there is no heteroscedasticity exists or occurs between the independent variables and the dependent variable.

#### 4.7 Hypothesis Testing

In this research, researchers is using two hypotheses testing which are F-test and T-test and also the coefficient of determination. The effect of independent variable individually toward dependent variable will be conducted using the partial T–test. On the other hand, F–test will be used to test the effect of all independent variables toward dependent variable simultaneously. To know how big the contribution of independent variables toward dependent variable by using coefficient of determination.

Table 4.5 below shows the regression equation for predicting the effect of the dependent variable from the independent variables:

$$\text{Customer's Loyalty (Y)} = -0.442 + 0.246X_1 + 0.231X_2 + 0.518X_4 + e$$

**Table 4.5.** Satisfaction, Trust, Communication, and Commitment toward Customer Loyalty

Dependent variable	Customer Loyalty (Y)			
Independent variables	Satisfaction (X <sub>1</sub> )			
	Trust (X <sub>2</sub> )			
	Commitment (X <sub>3</sub> )			
R <sup>2</sup>	0.615			
Adjusted R <sup>2</sup>	0.599			
Std Error	0.38347			
F	37.985			
N	100			
Ind var	b	Beta	t	Sig.
Constant	-.442		-1.033	.304
Satisfaction	.246	.201	2.830	.006
Trust	.231	.198	2.778	.007
Communication	.096	.072	1.100	.274
Commitment	.518	.562	7.760	.000

The multiple-linear regression used in this research to determine the influence between satisfaction, trust, communication and commitment toward customer loyalty as a dependent variable. The statistical operation in this regression will be done by SPSS for Windows (version 20.0).

From the data above Table we can conclude that:

a. *Satisfaction*

From the result by SPSS, the t-value of satisfaction is 2.830 with significance value of 0.006. With using 0.05 as a significant factor, the significance value is less than 5% or 0.05, thus H<sub>0</sub> is rejected and H<sub>a</sub> is accepted. Therefore, the first hypothesis (H1) is proven.

b. *Trust*

From the result by SPSS, the t-value of trust is 2.778 with significance value of 0.007. With using 0.05 as a significant factor, above significance value is less than 5% or 0.05, thus H<sub>0</sub> rejected is and H<sub>a</sub> is accepted. Therefore, the second hypothesis (H2) is proven.

c. *Communication*

From the result by SPSS, the t-value of communication is 1.100with significance value of 0.274. With using 0.05 as a significant factor, above significance value is greater than 5% or 0.05, thus H<sub>a</sub> is rejected and H<sub>0</sub> is accepted. Therefore, the third hypothesis (H3) is not proven.

d. *Commitment*

From the result by SPSS, the t-value of commitment is 7.760 with significance value of 0.000. With using 0.05 as a significant factor, the significance value is less than 5% or 0.05, thus H<sub>0</sub> is rejected and H<sub>a</sub> is accepted. Therefore, the fourth hypothesis (H4) is proven.

The F value that shows in the Table 3 is 37.985 greater than zero, and the significance is 0.000 which is less than 0.05. This condition means that  $H_0$  is rejected and  $H_a$  is accepted. Therefore, satisfaction, trust, communication, and commitment simultaneously have impact to customer loyalty. Hence, the fifth hypothesis ( $H_5$ ) is proven.

From the result of  $R^2$  test by the SPSS, the value of  $R^2$  test which is adjusted R square is 0.599. In this case, it means that 59.9% of the Customer Loyalty can be described by the variable of satisfaction, trust, communication and commitment. And the rest which is 40.1% was affected by other variables in which not examined and mentioned in this particular research.

## **5 Conclusions and Recommendations**

### **5.1 Conclusions**

Based on the research about Factors Influence Customers' Loyalty of Unilever Skin Care Product for Indonesian Market this specifically for Citra Skin Care Product that conducted in Cikarang, Indonesia some points can be concluded:

- a. From the multiple linear regressions calculation can be concluded that only three variables which are satisfaction, trust, and commitment that have significant impact towards customer loyalty, whereas variable of communication has no significant influence.
- b. The variable satisfaction has significant influence toward customer loyalty. the quality of Citra' products are the reason of their being loyal and the price of Citra's product also affects their satisfaction. It makes sense, consider if someone is not satisfied, one will not be happy and will not be willing to repurchase or reuse the products. This means that the level of satisfaction increases, the level of loyalty also increases. The influence of satisfaction on customer's loyalty is very significant and this is suitable with some previous literature. Davis-Sramek et al. (2009) opined that quality of product or service influences customer satisfaction directly and positively. In addition, "the higher customer satisfaction, the higher the retention" was stated by (Keller et al., 2012), which implied positive relationship between quality of product and retention or repeating purchasing.
- c. The variable trust has significant influence toward customer loyalty. Reviewing cosmetic and skin care product market in Indonesia nowadays, as stated before, all producers, particularly Citra, have been facing severe competition. Based on the result of this research, Citra's customers consider trust as a significant factor toward their loyalty. Compared with new players whose reputation has not been recognized widely, long-establishment of Citra has become a key advantage.
- d. The variable communication has no significant relationship toward customer loyalty of Citra. About the insignificant influence of communication toward loyalty, by interviewing some elements of the sample, researchers may conclude that the main reason is the use of Citra's advertising is not effective. The respondents are not attracted by advertising of Citra product because customers admitted that advertisements providing significant amount of information but doubted sincerity of those.
- e. The result of this research also showed that commitment is the most significant variable among all the variables. This implied that the company can keep customer continue cooperating with them when they get the customer's commitment.
- f. Overall, the variables that being examined in this research is 59.9% coefficient of determination. It means that there is 40.1% more aspect that could affect the customer loyalty that has not been discussed in this research. This number may come up since there is more measurements and indicators in that could be affecting customer loyalty and not used by researchers.

### **5.2 Recommendations**

Based on the conclusion stated above and the research as a whole, the following recommendations are offered as guidelines or suggestions for consideration and possible application by Citra in dealing with the customer's loyalty. The recommendations offered are as follow:

With regard to insight into demand of women customers, namely Indonesian women who refer a whitening skin, it is suggested that the Citra's products should have innovation in producing effectively product with whitening feature because Citra's customers do not really satisfy with ability to improve

the whitening skin. In addition, the pricing of skin care product should value for money, since the customers often do compare between the cost they spend and the benefit that they get. It is also because the customers often do compare the product to the competitors. According to Maybank Kim Eng Research, 2013, price of Unilever's Citra Soap is almost 30% more expensive than PT Wings' Giv because most main raw materials of Unilever are imported such as crude palm oil and derivatives, perfumes and other petrochemical products and management said that 60% of the company's total Unilever's cost of goods sold is denominated in USD. Researchers suggested that Unilever manager should research and made a manufacture plan that used the source locally is available in Indonesia so that they can decrease the COGS. About communication activities to better performance, it is advised that the marketer ought to note content of current advertising. The amount of information included in advertisings was supposed to be appropriate

They still question about trustworthiness of provided knowledge, in other words, content of the ads is not convincing enough. Therefore, mission of marketer is to balance amount of truthful information and marketing information so that customers can not only gain information about the product but also accept and believe it without hesitation. Using expert's recommendation or Citra users telling story in commercials are some suggestions. This move enhances credibility of brand which are deep-rooted in customer mind. Delivery sample to promote new line of product should be more concerned in order to attract customer to buy new product. Besides, the company should make some events in order to create a good relationship with the customers. The manufacturer is supposed to cooperate well with suppliers, big chains of supermarket in particular, to do sale promotion on product more often because customers considered promotional schemes like extra volume, bundling offer or price promotion, as an important influential factor of loyalty. Therefore, customer loyalty could be improved

## 5 References

### Journal Paper Reference

- Boora, K.K. and Singh, H. (2011) 'Customer Loyalty and it's Antecedents: A Conceptual Framework.', *Sri Krishna International Research & Educational Consortium*, vol. 2, January, pp. 151-165.
- Capel, C.M. and Ndubisi, N.O. (2011) 'Examining the Inter-relationships among the Dimensions of Relationship Marketing', *Asian Journal of Business Research*, vol. 1, pp. 64-70.
- Cheng, S.-I. (2011) 'Comparisons of Competing Models between Attitudinal Loyalty and Behavioral Loyalty', *International Journal of Business and Social Science*, vol. 2, no. 10, June, pp. 149-166.
- Evanschitzky, H. and Wunderlich, M. (2006) 'An Examination of Moderator Effects in the Four-Stage Loyalty Model', *Journal of Service Research*, vol. 8, no. 4, pp. 330-345.
- Flavián, C. and Guinaliú, M. (2006) 'Consumer trust, perceived security and privacy policy: Three basic elements of loyalty to a web site', *Industrial Management & Data Systems*, vol. 106, no. 5, pp. 601-620.
- Kumra, R. and Mittal, R.K. (2004) 'Trust and its Determinants in Internet Banking: A Study of Private Sector Banks in India', *Decision*, vol. 31, no. 1, January, p. 73.
- Lau, M., Chang, M., Moon., K. and Liu, W. (2006) 'The brand loyalty of sportswear in Hong Kong', *Journal of Textile and Apparel Technology and Management*, vol. 5, no. 1, pp. 1-13.
- Motamedifar, A., Nadimi, G., Mojdehi, E.M., Kandsari, A.G. and Razavipour, M. (2013) 'Relationship between relationship quality (RQ) and customer loyalty', *International Research Journal of Applied and Basic Sciences*, vol. 4, no. 7, pp. 1868-1871.
- Ndubisi, N. and Chan, K. (2005) 'Factorial and discriminant analyses of the underpinnings of relationship marketing and customer satisfaction', *International Journal of Bank Marketing*, pp. 54-57.
- Omotayo, O. (2011) 'Sales Promotion and Consumer Loyalty: A Study of Nigerian Telecommunication Industry', *Journal of Competitiveness*, pp. 45-56.

Punniyamoorthy, M. and Praj, M.P. (2007) 'An empirical model for brand loyalty measurement', *Journal of Targeting, Measurement and Analysis for Marketing*, pp. 222-233.

Rai, A.K. and Medha, S. (2013) 'The Antecedents of Customer Loyalty: An Empirical Investigation in Life Insurance Context', *Journal of Competitiveness*, vol. 5, no. 2, pp. 139-163.

Ranaweera, C. and Prabhu, J. (2003) 'The influence of satisfaction, trust and switching barriers on customer retention in a continuous purchasing setting', *International Journal of Service Industry Management*, vol. 14, no. 4, pp. 374-395.

Roberts-Lombard, M. (2009) 'Customer retention strategies implemented by fast-food outlets in the Gauteng, Western Cape and KwaZulu-Natal provinces of South Africa: a focus on Something Fishy, Nando's and Steers', *African Journal of Marketing Management*, vol. 1, no. 2, pp. 70-80.

Shavitt, S., Lowrey, P. and Haefner, J. (2000) 'Public Attitudes Towards Advertising: More Favourable Than You Might Think', *Journal of Advertising Research*, vol. 38, no. 4, pp. 7-22.

Son, Đ.G. (2013) 'Factors Influencing Local Customer Loyalty. Case: Low Cost Airline Vietjet Air in VietNam', September, pp. 68-69.

Spire (2013) 'Indonesian Market Focus Skin care & Cosmetic', vol. 1, no. 1, pp. 1-18.

## Reference

Black, K. (2011) *Business Statistics: For Contemporary Decision Making*, revised edition, John Wiley & Sons.

Cooper, D. and Schindler, P. (2011) *Business Research Method*, New York: McGraw-Hill Education.

Grewal, D. and Levy, M. (2014) *Marketing*, 4th edition, New York: McGraw-Hill/ Irwin.

Griffin, J. (2005) *Customer Loyalty: How To Earn It, How To Keep It*, USA: Jossey-Bass.

Kotler, P. and Armstrong, G. (2012) *Principles of Marketing*, 14th edition, New Jersey: Pearson Prentice Hall.

Lind, D., Marchal, W. and Wathen, S. (2012) *Basic statistic for Business and Economics*, McGraw-Hill Education.

Malhotra, N.K. and Peterson, M. (2010) *Basic Marketing Research: A decision making approach*, 6th edition, New Jersey, USA: Prentice Hall.

Mark, B.L., David, L.M. and Timothy, K.C. (2012) *Basic Business Statistic: Concepts and Applications*, New Jersey: Pearson Prentice Hall.

Oliver, R.L. (2010) *Satisfaction: A behavioral perspective on the customer*, illustrated edition, New York: McGraw Hill.

Rai (2014) *Customer Loyalty*, New Delhi: McGraw Hill Education (India) Pvt Ltd.

Reichheld, F.F. (2001) *The Loyalty Effect: The Hidden Force Behind Growth, Profits and Lasting Value*, Harvard Business Press.

Render, B., Stair, R.M. and Hanna, M.E. (2006) *Quantitative Analysis for Management*, New Jersey: Pearson Prentice Hall.

Sheth, J.N. and Mittal, B. (2004) *Customer Behavior: A Managerial Perspective*, 2nd edition, Thomson/South-Western.

Zikmund, W.G. and Babin, B. (2007) *Essentials of Marketing Research*, Australia: Thomson South-Western.

**Internet Websites**

*Global Business Guide Indonesia* (2014), [Online], Available:  
[http://www.gbgindonesia.com/en/manufacturing/article/2014/indonesia\\_s\\_cosmetic\\_and\\_skin\\_care\\_industry.php](http://www.gbgindonesia.com/en/manufacturing/article/2014/indonesia_s_cosmetic_and_skin_care_industry.php).

JakartaGlobe (2014) *gbgindonesia*, December, [Online], Available:  
<http://www.gbgindonesia.com/en/manufacturing/article/2014/> .

*Lucintel* (2014), December, [Online], Available:  
[http://www.lucintel.com/reports/personal\\_care/global\\_skin\\_care\\_products\\_industry\\_2013-2018\\_trend\\_profit\\_and\\_forecast\\_analysis.aspx](http://www.lucintel.com/reports/personal_care/global_skin_care_products_industry_2013-2018_trend_profit_and_forecast_analysis.aspx).

*Unilever* (2014), [Online], Available: <http://www.unilever.com/aboutus/introductiontounilever/>.

*Unilever* (2014), Available: <http://www.unilever.co.id/>



## STRATEGIES FOR STRENGTHENING THE GREEN ECONOMY ON SMES DEVELOPMENT IN SIDOARJO DISTRICT

Sriyono  
Postgraduate Program- Magister Management  
University Muhammadiyah of Sidoarjo  
Mojopahit Street 666B – Sidoarjo  
East Java-Indonesia  
Email : [sriyono@umsida.ac.id](mailto:sriyono@umsida.ac.id)  
Phone : 62 81390741119

### Abstract

**Purpose** – The purpose of the paper is to determine how the strategy of strengthening the green economy made by SMEs located in Sidoarjo District

**Design/methodology/approach** – This research is an interactive qualitative research, data collection is done from the primary source through direct interviews, validateion data by using this type of credibility, including triangulation of data, methods and theories

**Findings** – From this study showed that the strategies used by SMEs are using internal strategies and very dominant leader and pro-active performance of this strategy, so that the leader must be more innovate to succeed in their business activities

**Research limitations** - This study only discusses the strengthening of the green economy, regardless of other factors (performance, quality of product, production costs, etc.)

**Practical implications** – There are several implications of this research is to implement green business economic activity is expected environmental conditions surrounding the activities are not disrupted, the feedback of the company is the company will smoothly conduct business without any complaints from the surrounding community

**Originality/value** - This paper provides significant value because of the results and discussion based on the theory and a clear framework, in addition to how a company leader providing ideas and innovation to strengthen the green economy

**Keywords** – *Strengthening, SMEs, Green Economy*

**Paper type** - Research

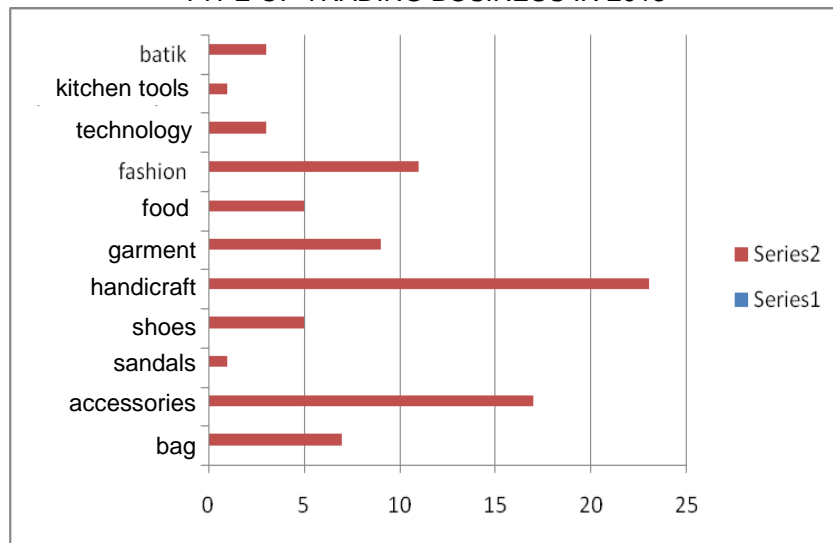
## CHAPTER I BACKGROUND

The growth of small and medium enterprises (SMEs) currently attracts various levels of society either the government or general public. It cannot be separated from SMEs condition that continues to develop and provide significant contribution, either in employment, national income contribution, and SMES endurance against economic fluctuation.

SMEs have an important function in advancing the economy of each country. Besides reducing unemployment rate by opening new jobs, SMEs also play a role in supporting the economic rate. It was shown in Indonesia in 1997, when monetary crisis in Indonesia, there were many big companies that went out of business and only SMEs that could survive. At that time, SMEs contributed significantly to regional income and national income of Indonesia (Hasanudin, 2008).

SMEs located in Sidoarjo District run in various types, such as industry of bags, sandals, shoes, handicrafts, garments, food, fashion, technology, kitchen tools, and batik that are spread in 18 districts.

Table 1.1  
 TYPE OF TRADING BUSINESS IN 2013



Source: Disperindagkop, 2013

The small enterprises also have significant contributions to develop the economy, serve the needs of local people, and become a prioritized part in each development stage planning organized by Department of Industry and Trade as well as Department of Cooperatives and SMEs (Disperindagkop, 2014).

Small-scaled industry can be one of main contributors to pollution, either solid waste, liquid waste, or gas (Mbuligwe, 2004), if the manual for standard placement and management of small industry has not been determined by the authority (Bhanarkar, 2002). Research on Green Economy SMEs located in Sidoarjo District has been conducted by Sriyono (2014), based on the research, it obtained data regarding SMEs development and identification of some companies that have run their business based on Green Economy. The research only identified which SMES that carried out business activities based on SMEs with some implemented indicators.

In general, there are four purposes of company establishment, i.e. profit, company survival, development, and social responsibility. This view encourages the economy players not only to optimize their profit, but also provide positive contributions for people and participate in preserving the environment. It is known that SMEs have technology, innovation, and application capability, and the most critical stage in facing this problem is how to make them aware of the importance of green-economy-based business for their business sustainability (Wang, Huili and Chunyou, Wu, 2010). Green economy is developed based on awareness of the importance of ecosystem that balances the activities of economy players with the availability of resources and environment. The concept of green economy is expected to be a solution, to be a bridge between development and social justice, environment-friendly, and efficient in using natural resource.

According to Nagayya (2011), in global condition, SMEs are required to upgrade their capability with innovations and adopt advanced technology and communication to improve the capability of entrepreneurs to improve their management without reducing the capability to satisfy public needs in the future. In other words, development activities must be able to bequeath prosperity to future generations in form of natural resource and environment assets at least the same as the ones we received from previous generations, added by science and technology.

Most companies apply profit maximization concept, but at the same time they violate the consensus and principles of profit maximization. The violated principles are economic cost, accounting cost, and opportunity cost. The violation implications are the neglected environment management, the low environment performance rate, the low company interest toward environment conservation. Violation of opportunity cost, for example, gives significant impact for global environment sustainability (Ja'far, 2006).

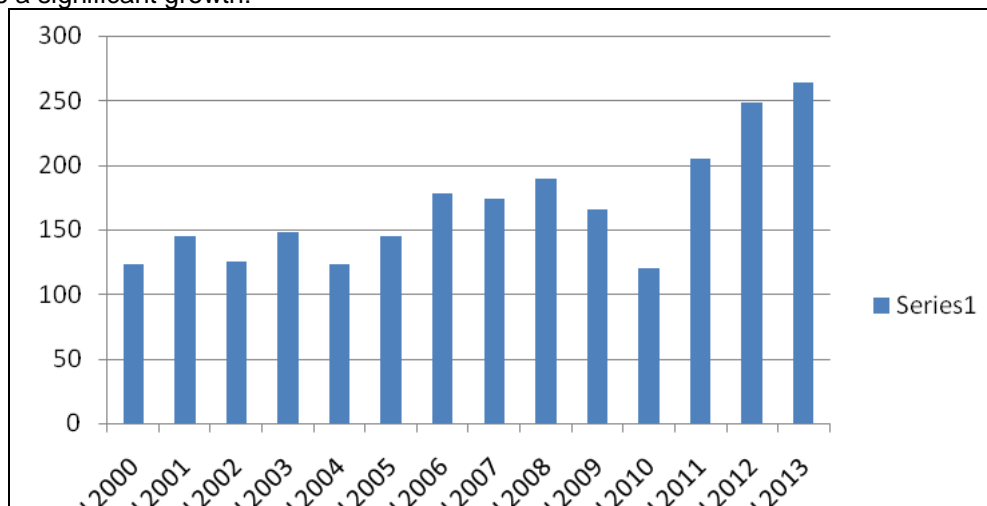
Environment uncertainty has negative significant effect, so that the decision to conduct proper environment in small and medium enterprises needs to be confirmed (Yu Lin, 2010). Therefore, the activities of a business development must be able to bequeath prosperity to future generations in form of natural resource and environment assets at least the same as the ones we received from previous generations, added by science, technology, and management. Green development is a strategy to improve economy growth aiming to improve the quality of ecology (Wang, 2011). It is the definition of sustained development that becomes the mainstream of economy and development. The concept of green economy will produce result if we change our behaviors. This phenomenon is called as maximization of shareholder paradigm. Green business is one part of green economy that synergizes economic, social, and environmental value despite the availability of cost for environmental improvement (Winter, 1994, Taylor, 1992). The phenomenon of green business becomes an attraction for various parties, either customers or investors. It means that customers will choose products and services that are healthy, quality, and safe for long period and does not pollute the environment although it is related to some costs to be incurred (Sarumpet, 2005).

However, business activities based on green economy needs to be performed continuously that needs an integrated approach (Noble, 2004) and strategies to be able to conduct business activities and asses SMEs sustainably (Fischer, 2002). Based on the background, the researcher is interested in how the SMEs entrepreneurs implement the strategies.

## CHAPTER II THEORETICAL BASIS

### 2.1 SMEs Development

According to Hubeis (2009), Small and Medium Enterprise (SMEs) is defined in some different ways depending on the country and other aspects. Therefore, specific review of the definitions needs to be conducted so as to obtain appropriate definition regarding SMEs, i.e. following the quantitative measurement in accordance with economic advancement. Small and medium enterprises (SMEs) constitute one of important parts of economy of a country or region, including Indonesia. As an illustration, although the contribution in national output (PDRB) is only 56.7% and in non-oil and gas export only 15%, SMEs give contribution about 99% in the number of business entities in Indonesia and have 99.6% shares in employment (Disperindagkop, 2014). The development of ESM in Sidoarjo District in the last ten years shows a significant growth:



Source: Disperindagkop, 2014

In Indonesia, there are some different definitions regarding SMEs based on the purpose of each department with different definitions. According Central Bureau of Statistics, SMEs is a company or industry with 5-19 workers. According to Bank of Indonesia, SMEs is a company or industry with characteristics: less than IDR 20 million capital, for a cycle of its business only needs IDR 5 million; having maximum asset for IDR 600 million excluding land and building; and annual income for IDR 1 billion. According to Department of Cooperative and SMEs (now

National Minister Office) (Law No. 9 Year 1995), ESM is small-scaled and traditional public economy activity, with net property for IDR 50 million - IDR 200 million (excluding land and building for business place) and annual income for IDR 1 billion; in Law of Micro, Small, and Medium Enterprises/2008 with net property for IDR 50 million - IDR 500 million and net annual sale for IDR 300 million - IDR 2.5 billion. According President Decree No. 16/1994, SMEs is a company having maximum net property for IDR 400 million. According to Department of Industry and Trading, SMEs is a company having maximum asset for IDR 600 million excluding land and building (Department of Industry before merged), or a company having working capital below IDR 25 million (Department of Trading before merged). According to Department of Finance, SMEs is a company having maximum annual income for IDR 600 million and/or maximum asset for IDR 600 million excluding land and building. According to Department of Health, SMEs is a company having quality standard signification in form of Instigation Certificate, Domestic Trademark, and Foreign Trademark (Hubeis, 2009). In other countries or in world level, there are some different definitions of SMEs according to the characteristics of each country, i.e.: According to World Bank, SMEs is a business with  $\pm$  30 workers, annual income for USD 3 million, and total asset not more than USD 3 million.

## **2.2 Performance of Small and Medium Enterprises**

General performance and competitive excellence is the benchmark of development and success of small companies. The factors determining company success by using data management and design system include data exchange frequency, digital data format reuse, the number of workers, and location.

Performance is a multidimensional concept, and correlation between entrepreneurship orientation and performance can depend on the indicators used to access performance (Lumpkin & Dess, 1996). Many empirical reviews report that there are many differences of performance indicators (Combs, 2005); generally it is the difference between financial performance and non-financial performance measurement.

The measurement of non-financial performance also measures the business goals such as satisfaction and success level in global scope that can be achieved by the owners or managers; the measurement of financial performance measures the factors such as sale growth and ROI (Smith, 1976). Related to financial performance, low convergence among different indicators often occurs (Murphy, Trailer, & Hill, 1996).

In conceptual level, one can differ the development measurement and the profitability measurement. Although the concepts empirically and theoretically relate each other, there are also important differences between the two (Combs, 2005). For example, a business can perform a large investment to support the business growth in long term, but must struggle to obtain short-term profit.

The main conceptual opinion regarding the correlation between entrepreneurship orientation and performance focused on performance financial aspect. Businesses having a high entrepreneurship orientation can target premium market segment, determine a high sale price, and occupy more excellent market position than their competitors that surely will result in more profits and sooner expansion (Zahra & Covin, 1995).

Data collection by financial report can provide a great opportunity to test the multiple dimensions of performance, such as a comparison with competitors (such as Wiklund & Shepherd, 2005). Such measurement can be a subject to cause bias due to the existence of social appropriateness, memory damage, and/or variation of methods usually used. Therefore, it is important to be implemented in this meta-analysis, i.e. to determine the measurement of effect of entrepreneurship orientation toward performance for financial and non-financial performance.

## **2.3 Innovation Strategy**

Basically, innovation is a conceptualization activity and idea to resolve problem by bringing economic value for company and social value for society. So, innovation departs from a previously existing matter, then it was given added-value. Innovation begins with matter that seems unimportant by opening eyes and ears to listen to aspirations and complaints from customers, workers, environment, and society. The subject of innovation implementation can be individual, group, or company.

Innovation strategy is related to response of company strategy in adopting innovation. In previous researches, various innovation strategy typologies have been used. There are 6

groups of innovation strategy typologies, i.e.: offensive innovation strategy, defensive, imitative, dependent, traditional, dan opportunist strategy. This grouping is based the acceleration and entry time of company toward new technology area (Hadjimanolis & Dickson, 2000).

Besides that, there is a thing differing the typology of innovation strategy and proactive strategy, where a company tries to predict and anticipate environmental changes. This type often constitutes a company that first implements innovation (first mover). The excellence is developing market share and reputation for innovation, but it also has weakness because it must incur large cost for development, and risks of wrong design or technology investment.

Reactive strategy is a company that only reacts to customers' request and competitors' activities, and tends to adopt innovation process of other company. This typology resembles the ones expressed in other researches: innovator (investor) and non-innovators (traders); innovative and innovative; innovative, quite innovative and following new product or service or innovative idea and competitive duplication (non-innovative) (Olson & Bokor, 1995).

### **CHAPTER III RESEARCH METHOD**

This research used qualitative approach. It was qualitative approach because the characteristics of collected data were qualitative, non-manipulative, more detail, and actual by seeing the problems and aims of research, where in this research, aiming to describe clearly, in details, thoroughly, and accurately regarding Green Economy-based SMEs development.

As a complement, it required data sourced from document from some related agencies. Moreover, in this research process, descriptive data in form utterances, texts, and behaviors of the people (subjects/informants) was obtained.

1. Research location

The research location was in some villages located in Sidoarjo District that were developing SMES in some sectors.

2. Research focus

This research focused to explore information, understand and analyze informants' opinion regarding strengthening strategy of green economy implemented by SMES entrepreneurs in Sidoarjo District.

3. Key informants or participants

The key informants in this research were SMEs entrepreneurs in Sidoarjo District and Head of Environmental Pollution Countermeasure and Monitoring Section, Environmental Agency, Sidoarjo District.

4. determination of informants or participants

The determination of key informants was based on the result of initial research conducted by Sriyono (2014), which selected SMEs entrepreneurs that had implemented their business activities based on green economy.

5. technique of data collection

Data is a collection of information required to make decisions. Data needs to be collected and arranged using certain method. From the aspect of data collection, it can be divided based on the sources.

Primary data is obtained from the first source containing considerations to produce relative priority scale assisted by a number of questions. Secondary data is a person or agency that has collected data, documents, and reports within certain period in accordance with research needs.

The method used to collect data in this research was (Marshall: 98-101):

- a. Observation

Observation method is used to complete data related to systematic observation and recording regarding the studies phenomena.

- b. Documentation

This method is used to fulfill the demand of secondary data needs.

- c. In-Depth Interview

This method is used to obtain the required data mainly related to primary data analyzed to prove the suggested hypothesis. The interview is guided by list of questions or questionnaire so as to continue according to the needs of data to be studied.

6. DATA VALIDITY TEST

Data validity test using Credibility Test (Rahardjo, 2010: 2-4) is a credibility test conducted by source triangulation, theory triangulation, and data triangulation from various sources, i.e. interview, observation of SMEs entrepreneurs, and others.

7. **TECHNIQUE OF DATA ANALYSIS**

According to Sugiyono (2007), data analysis is a systematic process of searching and arranging data obtained from interview, field note, documentation, and organizing data into categories, elaborating into units, synthesizing, arranging into patterns, selecting the important ones and the ones to be studied, and drawing conclusion so as to be understandable by other people or oneself. Qualitative data analysis is a continued, repeated, and continuous attempt consisting of three concurrent activities, i.e.: (1) data reduction; (2) data presentation; and (3) conclusion drawing/verification described by interactive analysis model (Miles and Huberman, 1984: 10-12) as the following:

- (1) **Data Collection**  
Data collection constitutes an integral part of a data analysis activity by using interview and documentation.
- (2) **Data reduction**, i.e. data obtained from research location (field data) is presented in complete and detailed description or report. The report from field was reduced, summarized, the main points were selected, focused on important matters that later the theme or pattern was searched.
- (3) **Data display**, i.e. facilitating the researcher to observe the whole illustration or certain parts of the research.
- (4) **Conclusion drawing**, i.e. since entering research location and during data collection process. The researcher attempted to analyze the collected data by finding pattern, theme, equation correlation, frequently occurring condition, and others that were contained in conclusion.

## **CHAPTER IV RESULT AND DISCUSSION**

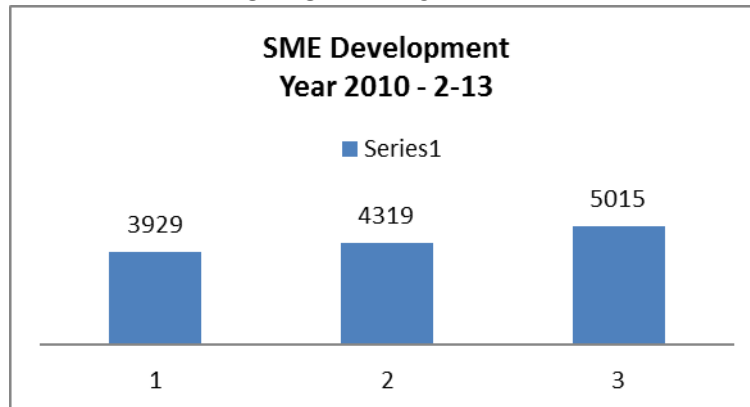
This research was located in Sidoarjo District including some villages where SMEs development was conducted.



## SMEs Development

SMEs development in Sidoarjo is shown in Table 1 below:

Table 1  
SMES DEVELOPMENT



Source: Desperindagkop, 2014

From data of the last three years, the increase of number of SMEs entrepreneurs is quite significant. It indicates people interest to be entrepreneur. It will result in employment availability that finally will improve the prosperity of local communities.

Based on the result of research conducted by Sriyono (2014), it indicates that the development of SMEs in Sidoarjo District is quite pleasing, although it only begins with minimum capital and few workers, but they can develop until now.

Besides that, it obtains data that the SMEs entrepreneurs in carrying out their activities, there are some entrepreneurs that have implemented Green Economy, i.e. company of ducks, metal, crackers, and bags. Begins from the research, it develops how the entrepreneurs implement strengthening strategies of green economy in their business.

## Green Economy Implementation

This study examined if production activities of the entrepreneurs had been based on Green Economy or not. Therefore, interview was conducted with some entrepreneurs, among others Mr. Edi Heriyanto, Dungus Village RT 018 RW 04 Sukodone District, an entrepreneur of duck eggs.

His comment is as the following:

*At the beginning of my business, I knew nothing about green economy. Doing business with profit was all that mattered for me. After a long time, I began to know green economy because of the explanation provided by an officer of Environmental Agency of Sidoarjo District. Therefore, how I can produce and gain profit but do not harm the environment, both my neighbors or people passing in front of my business location, and I have implemented it so far without my knowing.*

We asked the same question to an entrepreneur of crackers, H. Nurcholis, with address at Jl. Barokah No. 192 RT 04 RW 02 Telasih Village, regarding his business activities based on green economy that had been implemented. The following is his comment:

*I have heard about green economy term, but it became clear after the explanation from Environmental Agency. Essentially, green economy is a business activity that not only considers profit, but also an activity that does not harm local environment.*

Besides that, we also asked an entrepreneur of bronze handicraft, Mrs. Ratna, with address in Kebonsari Village RT 02 RW 02 Candi Sidoarjo, regarding business based on green economy. Below is her comment:

*I have watched on television regarding that matter, and then it was explained by Environmental Agency of Sidoarjo District. We are allowed to think about profit in running our business, but we are not allowed to harm local environment, either from the produced waste or from other activities, especially solid waste. Without my knowing, I have been doing that, I collected all solid waste separately from household waste because, in my opinion, it is hazardous and turns out that it is true.*

We crosschecked the answers conveyed by the entrepreneurs to the Environmental Agency of Sidoarjo District. Interview with Environment Agency represented by Head of Environmental Pollution Monitoring Section stated about business activities based on green economy. Here is the comment:

*It is true that we always conduct some instigations for small and medium entrepreneurs so that in implementing their productions, they keep considering the environment, thus, not only thinking about profit. So far, we notice that some entrepreneurs do not consider that matters. There are some possibilities of reasons why they do not consider that matters. First, it is probably due to their lack of knowledge regarding that matters. Second, they may know, but they face some difficulties in overcoming the problems, both in aspect of technology and fund to be used.*

*Therefore, we provide guidance gradually along with the simplest solution that does not burden the entrepreneurs, considering that they are small and medium entrepreneurs whose capital is not so much.*

It is know that green economy-oriented production process not only avoids pollution, but also prevents pollution. Therefore, we also asked the entrepreneur if they found any difficulties in implementing their business activities based on green economy.

Here is the comment:

*At the beginning, we faced some difficulties in implementing green economy. Due to the explanation from related agency, it became clear. For example, at the beginning of my business, I was confused because of the odor produced by my business, either from cages or remaining dishwater sourced from cages. Then I consulted the Environmental Agency of Sidoarjo District about how to overcome the problem. According to the Environmental Agency, duck dirt could cause odor due to the process of fermentation. The suggested step was to place a layer sourced from rice milling waste. The land before used for duck cages was given the layer with thickness of 15 cm above ground surface, so that the dirt would mix with the layer and reduce and eliminate the odor. (Mr. Edi Heriyanto, Dungus Village RT 018 RW 04 Sukodono District, an entrepreneur of ducks)*

We obtained the same answer from another entrepreneur. The comment is as follows:

*At that time, I directly disposed the waste sourced from production section along with other solid waste into trash can because I did not want to think much about the waste. After that, I knew that it was wrong so that I changed my way by separating the waste from another. (Mrs. Ratna, an entrepreneur of metal, with address in Kebonsari Village RT 02 RW 02 Candi Sidoarjo)*

The same went for the answer conveyed by the entrepreneur of crackers. The comment is as the following:

*Running business like that, the green economy, is actually hard because it needs additional energy and cost to collect all production waste and others. For the smoothness of my business, I still implement it to make my business more advanced. (H. Nurcholis, an entrepreneur of crackers, with address at Jl. Barokah No. 192 RT 04 RW 02 Telasih Village)*

We also crosschecked the answers from the entrepreneurs with Environmental Agency if the methods were appropriate. Here is the comment:

*Business orientation based green economy is indeed not easy, but we provide guidance gradually for the entrepreneurs regarding the process of business based on green economy and appropriate solutions for the activities. For entrepreneurs of ducks, the most serious waste is the odor caused by their dirt. So, the solution is by collecting the duck dirt and avoiding it to scatter in any place. The method is by placing a layer made of rice milling waste on the surface of ground to be used for cages. After that, periodically, if the amount of dirt has exceeded the layer of rice milling waste to hold the dirt, the layer must be replaced, and so forth. While, duck dirt mixed with rice milling waste is collected to be used as organic fertilizer by adding some additional ingredients.*



### **The strengthening strategy in Green Economy**

In the first study conducted by Sriyono (2015) has been obtained the result that there are some SMEs in their ordinary course of business have implemented green economy. In the next stage is how the strategy of entrepreneurs who apply green economy to maintain the sustainability. Therefore we conducted the interview with the entrepreneur, the comment is as follows:

*If I do not have specific strategies to maintain this business in order not to disturb my neighbor, periodically I invite all employees in a meeting to discuss this issue. I also explained that environmental factors must be maintained as well as best we can. For example, for the production I made schedule for the duck cage cleaning. In addition, I collected the waste derived from duck cage in a special place then I added other materials such as ash, compost, and manure, and I let it turn into fertilizer. For other places I clean it and I collect feces and made in the garbage disposal.*

*Other wastes originating from the former materials (cartons, eggs place etc) I collect and I re-sell them. Those are my steps, easy and I can do it.*

*In addition if there is training about the green economy held by the local government, namely the Department of the Environment then I will regularly follow it. (The result of interview with Mr. Edi Heriyanto Dungus Village NA.018 CA. 04 Sukodono Sub District)*

We asked the same thing to other craft SMEs , the following is the comment:

*The way I do is to tell my employees not to remove the existing dirt in any place, because the production waste from my factory is dangerous so that needs to be collected in special place. The easiest way is providing bins in all parts, so that rubbish can be accommodated and I also prepare the large shelters to temporarily accommodate all solid waste from the production. (Mrs. Ratna metal entrepreneurs located in Kebonsari Ward NA 02 CA 02 Candi Sidoarjo)*

We also asked the same question to cracker craft SMEs , what strategy they use to strengthen the implementation of Green Economy, this is the comment:

*I give understanding to all employees to maintain the cleanliness of scattered materials and all the waste from the production from raw material not to be disposed anywhere. I discuss with all employees together for handling the wastes in the factory. The employees are more active and innovate to propose the ways to overcome the problems that exist in the company.*

Then we made question cross check with the same question to Department of Environment of Sidoarjo District, the comment is as follows:

*We only carry out the duties in accordance with our responsibilities, we regularly conduct the training to entrepreneurs, especially on matters of keeping the environment in order to stay well. In addition, periodically we also invite them to be given training on the most recent environmental policy and on how to prevent environmental pollution.*

*Every business has different handling in keeping its environment, and thus different knowledge needed. Environmental sustainability is not only the responsibility of the employers but also a shared responsibility of society, employers and government. So the awareness of clean environment is a shared responsibility.*

*The main point is that business activities based on green economy needs to be undertaken in order to make the business smooth and continuous and not disturb the environment. To be able to keep it depends on the commitment of the leadership of the company, if he cares about it or not. Employees will be at the discretion of the leader, because in the end the risk will be borne by the leader.*

In addition to green economy strengthening, we also asked about the impact of such activity. As we know that to make a business activity to be oriented to the green economy takes time and thought, following comments from them:

*The first time I performed this way (green economy) was very heavy because all my employees did not understand about this way. I gradually in accordance with*

*the capabilities and innovation that I have tell them about it, thank God they can understand and it can be run up to now. In addition I also have more expense of having to prepare a lot of facilities for the activity, but it was only at the beginning after all is done the cost increases. When compared to the effect I can feel the good side of working with clean environment.* (H. Nurcholis, crackers entrepreneurs addressed at Jln Barokah No. 192 NA 04 CA 02 Telasih Village, Tulangan Sub District)

We also asked to other SMEs entrepreneur the impact after implementing green economy activity, as follows:

*It is difficult at the first time, every day I myself control their work in the field. Usually I only control production alone but now I need to control the cleanliness and produced waste. My employees have not been used to this kind of work, what they know is a lot result of work. Issues about cleanliness, waste about efficiency is not sufficiently understood it is because their education level is low. With patience and innovation, I eventually paid off, now I make them understand and I make schedule and they have already known and they implement it. To make them work smoothly then I spend extra cost for socialization, such as adding the trash, lighting, fixing leaky pipes or leaky pump and remind employees if there's a leak and the leak can be repaired immediately.* (Interview result with Mr. Sulaiman, Kebonsari Village NA05 / CA01 Candi Sub District, Sidoarjo)

We also gained similar answer from another entrepreneur, as follows:

*The clean activity is good, but also not easy to implement. Moreover, the culture of my employees from the beginning I started up this factory was less concerned. So I have to tell them first slowly, they can not immediately be reprimanded if work as they will and they need to be given the understanding. The result, as now, my factory is cleaner, but the cost I spend is more than the first time when I did not think about this way/ green economy.* (Mr. Pujiono, Bag Entrepreneur of Kedensari Village NA 15 CA 5 Tanggulangin Sub District)

## **DISCUSSION**

Based on the result of interviews with some SMEs entrepreneurs in Sidoarjo District, the entrepreneurs have nearly similar strategies. The implemented strategies are mostly oriented on internal strategies, where leadership factor and human resource are handled first. The role of leader is to be a motivator in creating green economy business. It indicates that leadership factor (Hackman and Johnson, 2000 and Lacy, 2012) is very dominant to give directions for workers. Besides that, it also needs transformational leadership and that has dynamical capability (Shan Chen, Yu and Ching-Hsun Chang, 2013). Some obstructions are faced by SMEs in implementing strategy to strengthen green economy condition, such as uncertain political condition, weak infrastructure, and human resource with low ability (Kotey, Bernice and Anthony Sorensen, 2014). Moreover, innovation from the leader is also required to strengthen green economy.

Clear job description regarding green economy definition for each worker will also facilitate the implementation and strengthening of green economy. Besides that, trainings for workers regarding business orientation based on green economy are required to form a culture and character for the company (Ellen Scully-Russ, 2013). Therefore, in business development in each country, recommendation to reinforce environment preservation is needed (Yasamis, 2007).

The existence of business activities with various kinds of technology is expected to minimize the pollution produced by them because it will have impacts in the future. According to Bey (2001), development of technology will not terminate a system, but constitute a reflection for sustainability in the future. Developing new skills, knowledge, and thinking pattern for next generation are the key for business leaders to accelerate critical points in sustainability integration in the core business.

Business activities based on green economy is not only implemented in production, but also started by environmental design, building design, product supply chain, warehouse for product storage, and other logistics (Nunes, Breno and David Bennett, 2010).

As an example, Japan has long implemented green environment in developing the country so that, in the industrial level, Japan is very advanced due to the industrial development based on green industry by following comprehensive security tradition, policy to contribute to national benefit, both from the aspect of economic prosperity and political stability by searching for new market outside the country, resource security, and security of cooperation relation with other countries (Okano, Maaike - Heijmans, 2012).

## CHAPTER IV CLOSING

### IV.1 Conclusion

1. The government provide guidance and direction of green economy-oriented process.
2. The strategies used by SMEs entrepreneurs are mostly oriented on internal strategy.
3. The role of leader is very dominant in directing the workers to achieve the green economy process.

### IV.2 Suggestions

1. The government is expected to provide guidance continuously to strengthen the green economy process by sustainable trainings.
2. The government is expected to provide Village Allocation Fund to help the strengthening of green economy process and actively participate in increasing the production of SMEs.

## Reference

- Bey, Cristoph, 2001, Changing Economies of Scale-Synergies between Implementation of an Ecological Tax Reform and Development of Industrial Ecosystem, *Business Strategy and The Enviromental*, 10, 383-393
- Bhanarkar., A.D., 2002, AssesSMEsnt of Air Pollution from Small Scale Industry, *Environmental Monitoring and AssesSMEsnt*, 80, 125–133, 2002, Netherlands: Kluwer Academic Publishers.
- Combs, J. G., Crook, T. R., & Shook, C. L. (2005). The dimensionality of organizational performance and its implications for strategic management research. In D. J. Ketchen & D. D. Bergh (Eds.), *Research methodology in strategic management*. (pp. 259-286). San Diego, CA:Elsevier
- Ellen Scully-Russ, 2013, The dual promise of green jobs A qualitative study of federally funded energy training programmes in the USA, *European Journal of Training and Development* , Vol. 37 No. 3, pp. 257-272
- Fischer, T. B. 2002. Strategic environmental assesSMEsnt performance criteria—The same requirements for every assesSMEsnt. *Journal of Environmental AssesSMEsnt Policy and Management* 5:83–99.
- Hasanudin. Nofri. <http://nofrihasanudin90.wordpress.com/2010/09/23/peranan-ukm-dalam-membangunkekompetitifan- perekonomian-indonesia>
- Hackman, M. and Johnson, C., 2000, *Leadership: A Communication Perspective*, Waveland Press, Long Grove, IL.
- Hubeis, Musa, 2009, *Prospek usaha kecil dalam wadah inkubator bisnis*, Jakarta: Ghalia Indonesia
- Hadjimonalis, Anthanasios., Keith Dickson (2000), Innovation Strategies of SMEs in Cyprus, A Small Developing Country, *International Small Business journal* . 18,4, pp. 62-79

- Ja'far, S, Muhammad dan Dista Amalia Arifah, 2006, *Pengaruh Dorongan Manajemen Lingkungan, Manajemen Lingkungan Proaktif dan Kinerja Lingkungan Publik Environmental Reporting*. National Symposium of Accountancy IX Padang 23-26 August 2006
- Kotey, Bernice and Anthony Sorensen, 2014, Barriers to Small Business Innovation in Rural Australia, *Australasian Journal of Regional Studies*, Vol. 20, No. 3, 2014
- Lacy, Peter, Arnaud Haines and Rob Hayward, 2012, Developing strategies and leaders to succeed in a new era of sustainability, Findings and insights from the United Nations Global Compact-Accenture CEO Study, *Journal of Management Development* ,Vol. 31 No. 4, pp. 346-357
- Lumpkin, G.T., & Dess, G.G. (1996). Clarifying the entrepreneurial orientation construct and linking it to performance. *Academy of Management Review*, 21(1), 135-172
- Madrid-Guijarro, A. Garcia, D. and van Auken H., 2009, Barriers to Innovation Among Spanish Manufacturing SMEs. *Journal of Small Business Management*, 47(40), pp. 465-488.
- Mbuligwe, Stephen E., 2004, Levels and Influencing Factors of Noise Pollution from Small-Scale Industries (SSIs) in a Developing Country, *Environmental Management* , Vol. 33, No. 6, pp. 830–839
- Murphy, G. B., Trailer, J. W., & Hill, R. C. (1996). Measuring performance in entrepreneurship research. *Journal of Business Research*, 36, 15-23.
- Miles, Matthew B, and Michel Huberman, 1984, *Qualitative Data Analysis*, Sage Publication, Inc
- Marshall, 2006, Qualitative Data Analysis, Online, (<http://www.sagepub.com/upm-data>, accessed on 24 Feb 2015
- Nagayya, D and T. V. RAO, 2011, Enabling Small and Medium Enterprises Target Globalization, *Productivity* , Vol. 52, No. 1, April—June
- Nunes, Breno and David Bennett, 2010, Green operations initiatives in the automotive industry An environmental reports analysis and benchmarking study, *Benchmarking: An International Journal*, Vol. 17 No. 3, 2010 pp. 396-420
- Noble, Bram F., 2004, integrating strategic environmental assesSMEsnt with industry planning: a case study of the pasquai-porcupine forest management plan, saskatchewan, canada, *Environmental Management* Vol. 33, No. 3, pp. 401–411, Springer-Verlag New York, LLC
- Okano, Maaike –Heijmans, 2012, Japan's 'green' economic diplomacy: environmental and energy technology and foreign relations, *The Pacific Review*, Vol. 25 No. 3, 339–364
- Olson. D. Philip, Donald W. Bokor (1995) Strategy Process-Content interaction : Effect On Growth Performance In Small Firm. *Journal of small Business Management*, pp. 34-44
- Rahardjo, 2010. *Triangulasi dalam Penelitian Kualitatif*, Sange Publication, Inc
- Sriyono, 2014, Implementation of Green Economy on The Development of SMEs in Sidoarjo District, *Proceeding Internationalan Conference International Conference on Entrepreneurship and Business (ICEBM)*, Penang- Malaysia
- Smith, P. C. (1976). Behavior, results, and organizational effectiveness: The Problem of Criteria. In M. D. Dunette (Ed.), *Handbook of Industrial and Organizational Psychology*, pp. 745-775).

- Sugiyono, 2007, *Metode Penelitian Kuantitatif, Kualitatif dan R & D*, Alfabeta Publisher, Bandung
- Sarumpaet, Susi, 2005, The relationship between environmental performance and financial performance of Indonesian companies, *Jurnal akuntansi & keuangan*, vol. 7, no. 2, november, 89- 98
- Shan Chen, Yu and Ching-Hsun Chang, 2013, The Determinants of Green Product Development Performance: Green Dynamic Capabilities, Green Transformational Leadership, and Green Creativity, *Journal Business Ethics*, 116:107–119
- Taylor, S. R. 1992. Green management: the next competitive weapon. *Futures* 24:669–680.
- Wang, Huili and Chunyou Wu, 2011, Green Growth as the Best Choice for Chinese Small and Medium Enterprises in Sustainable Development, *Asian Social Science*, Vol. 7, No. 5; May 2011
- Winter, G. 1994. *Blueprint for green management: Creating your company's own environmental action plan*. McGraw- Hill, London
- Wiklund, J. (1999). The Sustainability of the entrepreneurial orientation-performance relationship, *Entrepreneurship Theory and Practice*, 24(1), 37-48.
- Yu Lin, Chieh and Yi Hui Ho, 2010, The Influence of Environmental Uncertainty on Corporate Green Behavior : An Empirical Study With Small & Medium – Size Enterprises, *Social Behavior and Personality*, 38(5), 691 – 696
- Yasamis, Firuz D., 2007, Assessment of Compliance Performance of Environmental Regulations of Industries in Tuzla (Istanbul, Turkey), *Environmental Management* Vol. 39, No. 4, pp. 575–586
- Zahra, S. A., & Covin, J. G. (1995). Contextual influence on the corporate entrepreneurship performance relationship: A longitudinal analysis. *Journal of Business Venturing*, 10, 43-58

# **EDUCATION, ECONOMIC DEMOCRATION GROWTH IN ACHIEVING SUCCESS BUSINESS STRATEGY**

<sup>1</sup>siti nurjanah, <sup>2</sup>brenda Aurista Rumbajan

<sup>1</sup>Jakarta, Siti.nurjanah@kalbis.ac.id, 085694656985  
<sup>2</sup>Jakarta, brenda.rumbajan@kalbis.ac.id, 08194136136

## **Abstract.**

Education has a significant role for the economic growth, both for formal or non-formal education. Education will generate productivity, the higher the productivity, the better impact for National Economic growth. Whereas, the economic growth significantly affect the business strategy simultaneously. The strategy adjustment, were crucial in facing environment changes, including all aspect of education relatedness.

Economic growth significantly affect the business performance, nonetheless every aspect in the company will have an impact resulted from economic growth. The economic growth would affect the business strategy through the healthiness of economic growth somehow, furthermore the healthier the nation economic growth surely affected the company performance. The lowest the income per capita for Indonesian country, will have an impact for the business growth as well as for the business strategies being implemented. The result of this study gives some managerial implications regarding the education and economic growth that can be useful a better education.

**Keywords: Education, Economic Growth, Business strategy**

## **INTRODUCTION**

### **1. Background**

The performance of an organization can be seen from the quality of human resources who has an optimal performance. Performance is a situation that explains the success of an organization in carrying out its activities (Kaplan and Norton, 1992). Organization will successfully implement its business strategy if it has the competence resources. The human resources of the organization considered as a product of educational institutions. The organizational performance shown by the output level of educational institutions, the lowest the performance, it means that the effort from educational should be reconsider. Educational institutions need to have unique capabilities. According to John Kay (2003) in his book entitled Foundations of "Corporate Success" formulate unique capability as a special capability that have difficult to imitated nature and can be survive in the long term and possible to becomes a long term source of excellence.

Education has a role in the success of an organization's business strategy, the way through producing knowledgeable human resources and it can be useful to build a sustainable organization. The business strategy of an organization influenced by external factors one of which is the economy growth, where the economic growth is linked to the success of a business. The growth of economic democracy and education have a close relationship, where both components of these institutions is a state asset that requires careful management of. More specifically concerning the relationship of physical capital, labor and technology advances into three principal factors as input (inputs) in the production of national income. The greater the amount of labor (which means high population growth rate) the greater the higher national income and national growth.

### **2. Research Gap**

Absorption of college graduates is very low and not optimal. According to the Central Bureau of Statistics (BPS), 5.91% unemployed labor in Indonesia is coming from university graduates. Based on the data that a number of national labor force during the economic crisis in the first year (1998) of approximately 92.73 million people while the number of job opportunities that exist only about 87.67 million people and there are about 5.06 million people openly unemployed. This data is increasing steadily followed by the growing number of inhabitants.

From the fact that statistics is an evidence of the system weaknesses and the orientation of our educational institutions to creating readiness for workforce. More broadly, the magnitude of unemployment of educated who packed every corner in the Indonesian region is sufficient to prove the failure of our educational system.

Educational institutions should adopt a product that has the competence to support the economic and social well-being not creating a burden on society instead. The less graduates absorptions in the workplace indicate a failure of the educational institutions.

### Previous research

<b>Researcher</b>	<b>Topic</b>	<b>Variable</b>	<b>Analysis</b>	<b>Result</b>
<b>Eka Afnan Troena Armanu</b>	The influence of human capital and organizational learning and organizational competence mediated culture of innovation	Human capital Organizational learning Organizational competence Innovation culture Organizational performance	Quantitative Research	Intellectual capital is the most important and influential indicator of the performance of the organization
<b>Zulhanafi, Hasdi Aimon, Efrial Sofyan</b>	Analysis of factors affecting the productivity and the level of unemployment in Indonesia	Productivity Unemployment Education Health Economic Growth	Quantitative Research	Education and health variables significantly affect productivity
<b>Emerson Wagner Mainardes</b>	Strategy and strategic Management concepts : are they recognised by management students	Strategy Management	Qualitative Research	
<b>Eko Wicaksono Pambudi</b>	Analysis of economic growth and the influencing factors	Aglomerasi Investasi Angkatan kerja yang bekerja Human Capital Investment	Analisis panel data Eviews	Variable workforce and investment positive effect on economic growth
<b>CISCO</b>	Education and Economic Growth	Education' Economic Grwth	Panel Data	The form of schooling that emerged in the 19th century generates specific cognitive, behavioral and social knowledge that are critical ingredients for the way

				industrial societies organize
<b>Yesi Hendriani Supartoyo</b>	The Economic Growth and the regional characteristic : the case of Indonesia	Economic Growth	Panel data Regional characteristic	Workforce positively affect the economic growth

Table 1. Previous Research

### Heterogeneity level of public education

Heterogeneity education level of Indonesian society can be seen from the number of Indonesian population that has not received a decent education. By looking into some of the areas that are still lagging behind there are still many childrens dropped out of school. Indonesia has 183 disadvantaged areas. According to data from Kepmeneg.pdt.go.id there are several factors that cause the area is underdeveloped areas including:

1. **Geographic.** geographically disadvantaged areas are relatively difficult to reach because they are too far inland hills / mountains, islands, coastal, and remote islands or due to other geomorphological factors that are difficult to reach by both the transport network and communication media.
2. **Natural Resources.** Some disadvantaged areas do not have the potential of natural resources, the region has vast natural resources, but the neighborhood is a protected area nor can be exploited, and underdeveloped regions due to the excessive use of natural resources.
3. **Human Resources.** In general, people in disadvantaged areas have a level of education, knowledge, and skills are relatively low and indigenous institutions underdeveloped.
4. **Infrastructure.** Limited infrastructure and means of communication, transportation, water supply, irrigation, health, education, and other services that cause people in disadvantaged areas are experiencing difficulties in economic and social activities.
5. **Isolated Regions, Potential Conflict and Disaster Prone.** Physically disadvantaged areas isolated location, Disadvantaged Areas often experience social conflicts, natural disasters, earthquakes, droughts and floods, and causing disruption of social and economic development activities.

From the above data shows that there are still many people who are illiterate, especially in rural areas. At primary school level there are still many children who did not graduate from elementary school. This is also reflected in both secondary education. The main cause is the problem of poverty and the inability of parents to send their children to pursue higher education. Distribution of education in Indonesia, many constrained various factors including geographical constraints, limited educational facilities, centralized educational planning that ignores the capabilities and characteristics of the area.

### Indonesian economic downturn

The economic crisis that began in 1997 has an influence on the quality of education in Indonesia. The number of poor people is increasing and the number of unemployed has increased coupled with the presence of underemployment. Influence on the world of education is the increasing, the number of school dropouts at all levels. Social indicators are rising street children and families in the streets of major cities. Many students were forced to leave or quit due to the tuition fees, happened for Middle and High School students. A large number of school children will lead to higher unemployment will mempenagruhi economic development pertubuhan impact on the economy and the success of a business strategy.

### 3. Business Phenomenon

Some phenomena show that the performance of education in Indonesia is still not maximized, resulting in a product that is produced by our educational institutions have not been absorbed optimally. It is evident from the number of labor force and labor force participation rate is still a gap.



Tahun		Angkatan Kerja	Bekerja	Pengangguran	Tingkat Partisipasi Angkatan Kerja - TPAK	Tingkat Pengangguran Terbuka - TPT
		(Juta Orang)	(Juta Orang)	(Juta Orang)	(%)	(%)
2010	Februari	116,00	107,41	8,59	67,83	7,41
	Agustus	116,53	108,21	8,32	67,72	7,14
2011	Februari	119,40	111,28	8,12	69,96	6,80
	Agustus	117,37	109,67	7,70	68,34	6,56
2012	Februari	120,41	112,80	7,61	69,66	6,32
	Agustus	118,05	110,81	7,24	67,88	6,14
2013	Februari	121,19	114,02	7,17	69,21	5,92
	Agustus	118,19	110,80	7,39	66,90	6,25

Table 2. Labor Force (Source:Sakernas, BPS)

From the above data it can be seen that in 2013 the labor force is 66.90% (118.19 million), while the data show that the unemployment rate still reached 6.25% (7.39 million people) of the total labor force is 118.19 million people in Indonesia. These data indicate that all the work has not been absorbed service branch so that there are about 7.39 million people unemployed in Indonesia. By looking at the percentage of the unemployment rate still will affect the economic growth of one of them will affect the per capita income. The low per capita income of the Indonesian state will affect the business growth that will impact on business strategy will be applied.

### Unemployment by Education Attainment 2010 - 2014 \*)

No.	Pendidikan Tertinggi Yang Ditematkan	2010		2011		2012		2013		2014
		Februari	Agustus	Februari	Agustus	Februari	Agustus	Februari	Agustus	Februari
1	Tidak/belum pernah sekolah	63 183	163 954	96 852	205 218	129 258	86 397	113 389	81 432	134040
2	Belum/tidak tamat SD	552 531	616 104	566 349	748 742	602 511	513 875	523 936	489 152	610574
3	SD	1 496 250	1 387 220	1 281 605	1 233 475	1 404 892	1 447 454	1 416 155	1 347 555	1374822
4	SLTP	1 594 931	1 624 666	1 796 178	2 117 407	1 710 992	1 703 326	1 811 920	1 689 643	1693203
5	SLTA Umum	2 071 192	2 148 740	2 326 651	2 374 469	2 014 074	1 854 362	1 859 727	1 925 660	1893509
6	SLTA Kejuruan	1 305 665	1 188 397	1 077 462	1 157 813	1 002 867	1 058 412	857 585	1 258 201	847365
7	Diploma I,II,III/Akademi	537 881	442 281	455 367	279 921	253 840	198 688	195 427	185 103	195258
8	Universitas	813 863	683 064	619 617	542 682	546 294	443 518	421 073	434 185	398298
	<b>Total</b>	<b>8 435 496</b>	<b>8 254 426</b>	<b>8 220 081</b>	<b>8 659 727</b>	<b>7 664 728</b>	<b>7 306 032</b>	<b>7 199 212</b>	<b>7 410 931</b>	7147069

Table 3. Unemployment by Education (Source: Sakernas BPS)

From the above data shows that the product of the institution as a producer of the product of labor is not maximized, it is apparent from the open unemployment in Indonesia. In 2014 there were university graduates still have not absorbed in the labor force. The above data indicate that the competency of the lower product education.

National seminar on "UT" shows that productivity and labor expertise in Indonesia is still very low, so it can not compete with workers from other countries. Institutions in Indonesia should improve the performance and quality of the resulting education, because education is the product of the graduates to be absorbed in the world of work. An organization will experience good growth if it is supported by a source that has the competence human resource reliable.

The data also showed that the level of educational equity is still not evenly, it can be seen from the number of Indonesian people who drop out of school. Here the data from BPS who wrote about the level of Illiteracy in Indonesia

Indicator	2010	2011 <sup>***</sup>	2012	2013
<b>Illiterate</b>				
Figures Illiteracy 10 th +	6,34	6,80	6,28	5,46
Figures Illiteracy 15 th +	7,09	7,56	7,03	6,08
Figures Illiteracy 15-44 th	1,71	2,31	2,03	1,61
Figures Illiteracy 45 th +	18,25	18,15	17,17	15,15

Table 4. Illiteracy level (Source: BPS-RI, Susenas 1994-2013)

From the above data can be seen that the Indonesian population still illiterate it shows that education in Indonesia is still not evenly distributed. Here we can see that there is a force that is supposed to be an illiterate workforce. Another phenomenon that causes her no smoothing education is still about 183 areas in Indonesia is still in the category of disadvantaged areas.

Data from the Ministry of regional development of underdeveloped countries shows that the criteria developed areas is done with Determination of criteria developed areas and it is done by using the relative approaches based on the calculation of the six (6) basic criteria and 27 main indicators, namely: (i) the community's economy, with the main indicators of a percentage poor families and consumption per capita; (ii) human resources, with the main indicators of life expectancy, the average length of school and literacy rates; (iii) infrastructure (infrastructure) with the main indicators of the widest number of road surface asphalt / concrete, paved roads, dirt roads, and other roads, the percentage of users of electricity, telephone and water, the number of villages with a market without a permanent building, the number of health facilities / 1000 population, the number of doctors / 1000 inhabitants, the number of elementary and junior high / 1,000 population; (iv) the financial capacity of the area with the main indicators of fiscal gap, (v) the accessibility of the main indicators of the average distance from the village to the district, the distance to the education ministry, the number of villages with access to health services is greater than 5 km, and (vi) the characteristics the main indicator of the percentage of area with villages prone to earthquakes, landslides, floods, and other disasters, the percentage of villages in protected areas, critical landless rural and conflict-prone village last year. With these criteria, then there are currently 183 districts are categorized as Underdeveloped Regions in Indonesia. List of the district have been included in RPJMN 2010-2014 as a target of Rural Development. Deployment largely underdeveloped regions (70%) are currently disadvantaged areas in eastern Indonesia.

The success of an organization will be determined by the organization business strategy. By looking at the total labor force, where the amount of labor absorption slightly ineffiecient, and it can be seen from the amount of university graduates, high school as well as diploma graduates found it to be difficult to work in a company. The absorption level of the workforce were significantly low. Based on that,

curiosity about the competency of products of education are being questioning whether those graduates are incompetent or the education has something to do with it.

From the background of the problem, research gaps and business phenomenon above can be some problems related to the above items include the role of education affects the business strategy, the role of economic democracy to the business strategy and the role of education to the growth of economic democracy.

#### **4. Research Questions**

1. Is there a role of education in achieving successful business strategy
2. Is there a role heterogeneity educational level of the organization's growth strategy
3. Is there a role competencies of graduates to the organization's growth strategy
4. Is there a role Democracy Economic Growth in achieving successful business strategy
5. Is there a role of the labor force for the organization's growth strategy
6. Is there a role of unemployment on organizational growth strategy
7. Is there a role between education and economic growth

#### **5. Objective**

1. Recognizing the importance of education in achieving successful business strategy.
2. Recognizing the importance of education to the level heterogeneity organizational growth strategy
3. Recognizing the importance of competencies of graduates to the organization's growth strategy
4. Recognizing the importance of Democracy Economic Growth in achieving successful business strategy
5. Recognizing the importance of the workforce to organizational growth strategy
6. Recognizing the importance of unemployment for organizational growth strategy
7. Recognizing the importance of education to economic growth

#### **Benefits of Research**

The benefits in this study were divided into two, namely the benefits of the development of science and Practical benefits.

This research is expected to contribute to the development of science as follows:

##### **1. Benefits of Development Studies**

This research is expected to contribute to the development of science as follows:

- a. The results of this study can increase the repertoire of knowledge in the field of strategic management, especially with regard influence economic growth and education to business strategy
- b. Results are expected to provide useful information and be referensii to conduct further research

##### **2. Practical Uses**

This research is also expected to have practical utility as follows:

- a. As a reference for practitioners to improve their business strategy
- b. As a reference in formulating corporate strategy
- c. As a reference for the government, especially the ministry of Education and Economic in formulating policy for the development of education in Indonesia.

## **2. LITERATURE REVIEW**

### **2.1. Development proposition**

#### **2.1.1. Strategic Management**

Definition of strategic management of some opinions:

- a. The art and science of formulating, implementing, and evaluating cross-functional decisions that enable an organization to achieve its objectives (Fred R. David, 2005)

- b. The strategic management field can be conceptualized as one centered on problems relating to *the creation and sustainability of competitive advantage*, or the pursuit of rents (Bowman, Singh, and Thomas, 2002)
- c. Strategic management is about the direction of organizations, most often, business firms. It includes those subjects of primary concern to senior management, or to anyone seeking reasons for success and failure among organizations (Rumelt, Schendel, and Teece, 1994).
- d. Strategic management can be defined as the formulation, implementation, and evaluation of managerial actions that enhance the value of a business enterprise (teece, 1990)

From the above definition researchers conclude that strategic management is a science and art of formulating, mengimplemntasi, menkreasikan and evaluate all activities of the organization for the sustainability of the organization and to achieve a competitive advantage.

#### External Business Environment

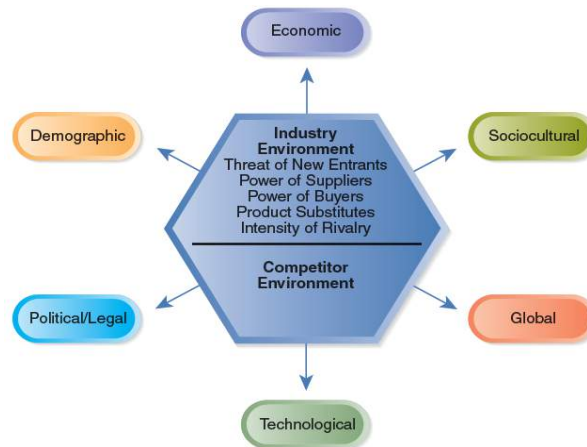


Figure 1 External Business Environment

In an organization certainly can be influenced by the external environment including Politics / Legal, Technological, Global, Demographic, sociocultural, Economic. This study will discuss the effect of economic and human resources capability in this case is the product of a successful educational institutions in key business strategy.

#### Competency of human resource

An organization will achieve success if the organization has a unique capability. The uniqueness of capability is a concept in strategic management theory that developed from the perspective of resource-based thinking. In this case the human resources is considered as a source of organization Excellencies. Human resources and competencies that have unique capabilities should be produced by the institution.

From some of the resources owned by one or more organizations that held the organization better than competitors so called unique capability (distinctive capabilities) (Barney & Hesterly, 2008)

John Kay (2003) in his book entitled Foundations of Corporate Success formulate unique capability as a special capability that have imitated the difficult nature and can survive in jangka long time so that it becomes a source of excellence in the long term.

#### Economic Growth

Economic growth can be interpreted as an increase in long-term capacity of countries to provide a wide range of economic goods to the people. The increase in the capacity of a country can be determined or made possible by the development of technology, the amount of increase penduduk, the conditions of a country, the equalization of income for the population of a country. The economic growth of a country can be seen from the level of unemployment, inflation and so forth.

#### Corporate Strategy

Corporate strategy is the way a company to create value through the configuration and coordination of activities in multipasar, the goal of corporate strategy is to create corporate excellence to improve the performance of business units and corporate performance above the average performance of the corporation as a whole (Collis & Montgomery, 2004). Wheelen and Hunger (2010) explained that there

are three alternative strategies that can steer the development of a corporation that is a strategy of growth (growth strategy), a business unit reduction strategy (retrenchment strategy). Based on the understanding that the large corporations that have the availability of resources (resources availability)

## 2.2. State of the Art Propositions

Based on the search results of previous studies researchers have state of the art proposition of this study as follows:

This study has a distinct difference compared with other studies. Differences were used in this study: education variables used in this case is the product of education that produces human resources that have the capabilities associated with economic growth which in this case is influenced by several factors such as unemployment, labor force etc. In addition, this study puts the role of the two variables above to the success of corporate strategy

## 2.3. Framework

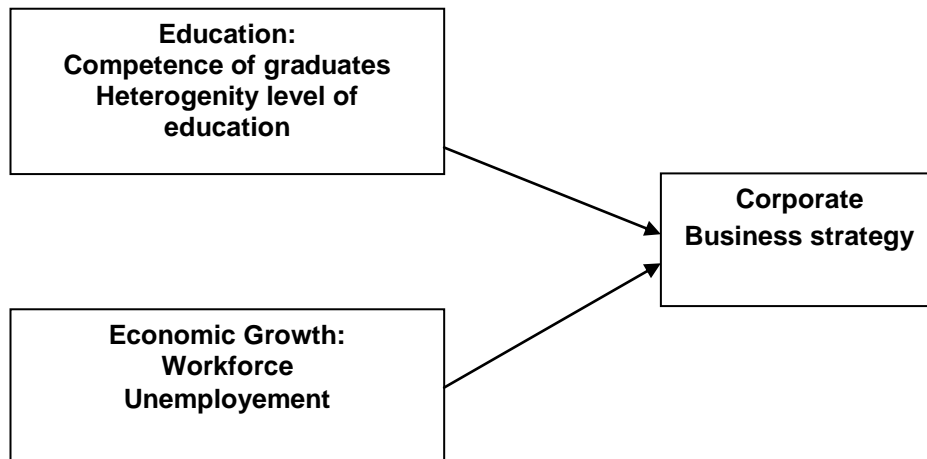


Figure 2. Framework of study

## 2.4. Development of basic theoretical

The theory upon which this study examined sequentially starting from the theory of macro-level, mid-level theory to the theory of micro level. The theory is at the macro level is the grand theory which became another source is the theory of mid-level and micro level

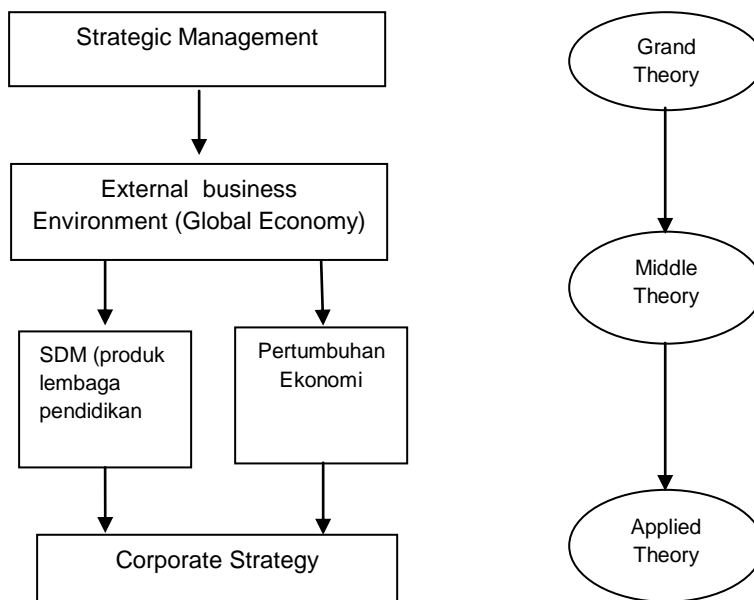


Figure 3. Development of Theory

## 2.5. Research Model

This research model can be described as follows



Figure 4. Research Model

## 2.6. Research Hypotesis

The hypothesis of this study is:

- H1 There is the role of education in achieving successful business strategy
- H2 There heterogeneity role of education level of the organization's growth strategy
- H3 There is a role competencies of graduates to the organization's growth strategy
- H4 There Democracy Economic Growth role in achieving a successful business strategy
- H5 There is the role of the labor force for the organization's growth strategy
- H6 There unemployment roles to organizational growth strategy
- H7 There are roles between education and economic growth

## 3. RESEARCH METHODS

### 3.1 Methods

This study used a descriptive research design to accurately describe the role of education and economic growth to the success of the business strategy. Source of data used in this research is secondary data sources that include the source of the Directorate General of Higher Education, Central Bureau of Statistics.

Data collection techniques used by using the techniques of documentation. This documentation techniques used to obtain secondary data presented in the form doukmentasi who came from the Directorate of higher education, the Central Bureau of Statistics. Data obtained with documentation techniques help to explain the phenomenon of the role of education and economic growth in the success of the business strategy.

The design of data analysis used by using descriptive analysis. This analysis explains the role of education and economic growth in the success of the business strategy.

### Library Research

This study uses literature which means data collection techniques using study review of books, literature, records and reports report that has nothing to do with the problem being solved (Nasir, 1988; 111). Sources library to which it is used in this study are books, journals, research results (theses and dissertations) and other sources.

### Qualitative Method of Analysis

This study used a qualitative research mengidentifikasikasi characteristics and structure phenomena and events in their natural context. Penelitian based on the fact that penegetahuan of

reality can only be obtained from other sources. This study develops a theory about the reality of a particular situation. The data in this study is derived from the results of focus group forums conducted by researchers with the respondents who have certain criteria. Respondents in this study came from several educational institutions, government, and industry representatives.

#### **4. DISCUSSION AND ANALYSIS**

##### **4.1. The role of education in successful business strategy**

Education is an institution set up by the government which will generate human resources that will be absorbed by the company. In this case the education required to produce qualified human resources. The company in this case plays a role of micro level to adopt the vision, mission and strategy that is supported by the human resources strategy and corporate culture right. The Company will be successful if it is supported by the Human Resources strategy that have the values of creativity, innovation and continuous learning.

Education condition in Indonesia can be seen from the illiteration level, there are still a number of populations suffer from that, and unfortunately it means that the educations in Indonesian are not evenly distributed. Another phenomenon showed the fact that Education are not evenly distributed can be seen from the category of disadvantage areas remains about 183 areas, and the contribution from this area will be significantly affect the whole areas in Indonesia.

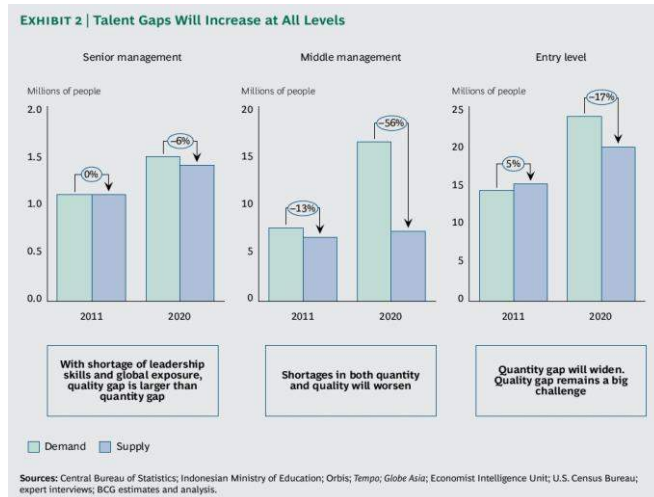
Data from the Ministry of regional development of underdeveloped countries shows that the criteria of developed areas using the approach of Determination of criteria and it is done by using the relative approach based on the calculation of the six (6) basic criteria and 27 main indicators, namely: (i) the community's economy, with the main indicators of a percentage poor families and consumption per capita; (ii) human resources, with the main indicators of life expectancy, the average length of school and literacy rates; (iii) infrastructure (infrastructure) with the main indicators of the widest number of road surface asphalt / concrete, paved roads, dirt roads, and other roads, the percentage of users of electricity, telephone and water, the number of villages with a market without a permanent building, the number of health facilities / 1000 population, the number of doctors / 1000 inhabitants, the number of elementary and junior high / 1,000 population; (iv) the financial capacity of the area with the main indicators of fiscal gap, (v) the accessibility of the main indicators of the average distance from the village to the district, the distance to the education ministry, the number of villages with access to health services is greater than 5 km, and (vi) the characteristics the main indicator of the percentage of area with villages prone to earthquakes, landslides, floods, and other disasters, the percentage of villages in protected areas, critical landless rural and conflict-prone village last year. With these criteria, then there are currently 183 districts are categorized as Underdeveloped Regions in Indonesia. List of the district have been included in RPJMN 2010-2014 as a target of Rural Development. Deployment largely underdeveloped regions (70%) are currently disadvantaged areas in eastern Indonesia

The success of an organization will be determined by the organization's business strategy itself, which is through increasing the HR strategy, by seeing the amount of labor force being absorbed, the data showed that the percentage amount of high school diploma as well as the university graduates are still below the standard. Therefore, the competence of those graduates is then being questioning. The absorption levels of graduates in the workplace are still low. The amount of graduates that are not absorbed into the world of work, need to be resolve, as it is become the problem for the industrial as well as the world of education. The sustainability of the organization is depending on the strong HR strategies. The competencies owned by the graduates will then determine the quality of the human resources itself also the tendency to be always being innovate. Based on the FGD followed by the researcher, there are some gaps found out between the world of education the world of industrialism, which are:

1. Graduates do not have the competencies expected by the industry
2. Graduates can apply the theory learned in college with a real job
3. Graduates do not have enough character
4. Graduates do not have leadership

From the above statement, the need of graduates who have the capabilities and qualities to accommodate the needs in the industrial workplace. Some facts should be noted that for the next few years Indonesia will be a shortage of qualified resources data show:

Perusahaan di Indonesia menghadapi isu kuantitas dan kualitas karyawan yang bertalenta di semua level dalam organisasi. Saat ini Indonesia kekurangan tenaga terampil menengah sebesar 20%



### Kondisi SDM Indonesia

Pada tahun 2020, perusahaan-perusahaan besar tidak akan mampu untuk memenuhi kebutuhan posisi entry-level dengan kandidat yang berkualitas baik.

55% pekerjaan di Indonesia akan bersifat administratif atau manajerial, dibandingkan dengan saat ini yang sebesar 36%.

Indonesia belum mampu menghasilkan lulusan perguruan tinggi berkualitas untuk memenuhi posisi tersebut.

6

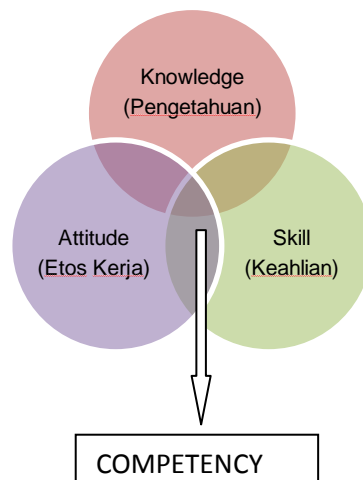
**Source : Knowledge Management Sharing Economic Faculty Kalbis Institute**

Organizations and companies in Indonesia will face several problems including the quantity and quality of the labor force. Facts showed that:

- In 2020 the companies will not be able to meet the needs of entry-level positions with good quality candidates.
- 55% work in Indonesia would be an administrative or managerial, compared with the current 36%.
- Indonesia has not been able to produce qualified graduates to fulfill the position.

This condition indicates HR Indonesia a few years that we lack of resources of good quality. With the lack of human resources in business organizations Indonesia would not be able to compete in the competitive situation.

Based on the result of FGD by the professional associations stated that the company will have a competitive edge if it has a competitive advantage, competitive advantage is derived from the ability of human resources owned by the organization. In order for an organization to have a standard of excellence then human resources should have a real competence.



**Figure 6 Competency**



- ✓ Competent means the ability and authority possessed by a person to do a job, which is based on the knowledge, skills and attitudes in accordance with the specified performance.
- ✓ Standard competency are statements that describe the skills, knowledge and attitudes that must be done at work and its application, in accordance with the requirements set by the workplace (industrial).

The success of a company's business strategy will be determined by the competence of its human resources. So that educational institutions should issue graduates with superior competencies that will have an impact on organization's business performance.

#### **4.2. The role of heterogeneity level of education of the organization's growth strategy**

Company strategies will slow down whenever the gaps of uneven distribution of educations among the areas happens this high gap in an area with other areas in terms of education makes the uneven level of education and economic growth across the region in Indonesia become permanently crucial for the economic growth. Therefore, it is necessary to build an awareness among government officials in managing and maintaining social inequality in Indonesia. Heterogeneity level of education will make every graduate gaps generated, therefore each college should educated teachers and equipped them with technological skills. In an effort to meet the needs of optimal learning in schools, governments pursue policies to face the challenges of the development of science and technology very quickly should be as follows:

1. Increase the academic ability and welfare of educators, where the educators should be able to optimally function, especially in the improvement of science education and science of information technology.
2. Improve the quality of the education institutions organized both by the society and by the government to strengthen the education system so that it can be effective and efficient in dealing with the development of science, technology, and art.
3. Necessarily used the technology and other media instructional
4. Thinking creatively within each teacher to create innovations and learning by utilizing information technology.

It is intended that the omission of the above areas exist in Indonesia especially amongst the underdeveloped have an equal levels of education. If heterogeneity is resolved will make the equalization levels of education have an impact on the quality of human resources is one of the basic organizational success.

#### **4.3. The role of competence of graduates of the organization's growth strategy**

Graduates of educational institutions have a role in fostering the growth of the organization. The role of competence of graduates in enhancing the growth of the organization is one where the organization has qualified human resources. The strategy should be developed by every institution through the development of student competencies, both for soft skills and hard skill. Soft skill competencies required by the organization are:

1. Commitment, commitment will emerge through the motivation to have the organization. Creating a sense of belonging will be the willingness to do a job in earnest.
2. Willingness to learn. A graduate should be able to deal with and respond to a stimulus response so as to face the global changes.
3. The spirit of trying, graduates must have the spirit of trying to be able to adapt to any changes in the environment both organized and outside the organization.
4. Ethics and Integrity, graduates who have good ethics and integrity can be easily to adapt in any situation, the character building is one of the important things to be developed.

Thus, for graduates it is important to have those competencies in order to survive in the internal and external environment which will have an impact for the organizations sustainability.

#### **4.4. The role of the labor force for the organization's growth strategy**

Labor Force, Employment, and Unemployment Labor is a resource for development activities. The number and composition of the labor force will continue to undergo along the changes of demographic processes.

Tahun		Angkatan Kerja	Bekerja	Pengangguran	Tingkat Partisipasi Angkatan Kerja – TPAK	Tingkat Pengangguran Terbuka - TPT
		(Juta Orang)	(Juta Orang)	(Juta Orang)	(%)	(%)
2013	Februari	121,19	114,02	7,17	69,21	5,92
	Agustus	118,19	110,80	7,39	66,90	6,25

Labor force in February 2013 amounted to 121.19 million, the working population of 114, 02 million, and the unemployment rate to 7.17 while working participation level of 69.21 and unemployment at 5.92%. Within months, a significant increase in the labor force in August 2013 amounted to 118.19 million, the working population of 110, 80 million, and the unemployment rate to 7.39 while working partisipasi level of 66.90 and unemployment of 6.25%

Labor Force Participation Rate (LFPR), indicating the size of the working age population that is economically active in a country or region. LFPR was measured as a percentage of the labor force to the working age population. This indicator shows the relative magnitude of the supply of labor (labor supply) are available to produce goods and services in an economy. From February 2013 until August 2013 LFPR decreased by 9.6 percent, from 69.21 million to 66,90juta. This increase is partly due to the national socio-economic conditions unfavorable, thus giving effect to the factors of production in Indonesia. Directly ups and downs of production factors will have an impact on the level of factor demand and supply of labor.

Employment growth is higher than the employment growth will lead to decreasing employment levels. Thus the working population does not always describe the number of employment opportunities. This is due to the frequent occurrence of mismatch in the labor market. Labor force which is not absorbed in the labor market can be caused by several factors, including lack of competence and knowledge workers, the lack of manpower so companies need to hire workers from abroad and it is possible to cost quite a lot. The high cost of labor will reduce corporate profits will consequently inhibit the growth of the organization.

#### 4.5 The role of unemployment to the organization's growth strategy

Unemployment categorized as a person ready to work and wished to get a job, but have not been able to obtain it. Unemployment problem which causes the level of national income and the level of prosperity of the people do not achieve their full potential is the main problem that most major macroeconomic.

Unemployment is often interpreted as a labor force that has not been working or not working optimally. Based on the above understanding, the unemployment can be divided into three kinds:

1. Unemployment Covert (Disguised Unemployment) is a workforce that does not work optimally for a particular reason.
2. Half Unemployed (Under Unemployment) is a workforce that does not work optimally because there are no jobs, usually labor is underemployed workers who work less than 35 hours during the week.
3. Unemployment (Open Unemployment) is a workforce that truly do not have a job. This type of unemployment is pretty much as it has not got a job yet been tried to the fullest.

Various causes of unemployment based on grouped into several types, namely:

- a) Unemployment conjunctural (Cycle Unemployment) is unemployment caused by changes in wave (rise and fall) economic life / economic cycle.
- b) Structural unemployment (Structural Unemployment) is unemployment caused by changes in the economic structure and economic patterns in the long term.
- c) Unemployment structural can be caused by several possibilities, such as:
  - As a result of reduced demand
  - Due to the advancement and use of technology
  - As a result of government policy

- d) Frictional unemployment (Frictional Unemployment) is unemployment arising from a mismatch between employers and job seekers. Unemployment is often called voluntary unemployment.
- e) Seasonal unemployment is unemployment that arises due to the change of seasons such replacement planting to harvest.
- f) Technological unemployment is unemployment due to the change or replacement of human labor into power machines
- g) Unemployment is a cycle of unemployment caused by the decline in economic activity (due to the recession). Cycle of unemployment caused by the lack of public demand (aggrerat demand).

### **Causes of unemployment**

Factors that lead to unemployment are as follows:

1. The amount of the Labor Force Employment Unbalanced
4. The imbalance occurs when the labor force is greater than the available employment opportunities. Otherwise very rare condition.
2. Structure of Employment Unbalanced
3. The need for the amount and type of skilled manpower and supply of skilled manpower unbalanced

Of the three factors that will greatly affect the growth of the organization is the third factor which is the inbalancing amount of skilled manpower and supply of skilled manpower.

### **The impact of unemployment**

To determine the impact of unemployment on the economy we need to classify the effect of unemployment on two aspects of the economy, namely:

#### **a. Economic Impact of Unemployment on a State**

The ultimate goal of economic development of a country is essentially increase the prosperity of the community and for stable economic growth and the state continue to rise. If the unemployment rate is relatively high in a country, it would hinder the achievement of economic development goals that have aspired. This happens because the unemployment negative impact on economic activity, as described below:

- Unemployment can lead to the inability to maximize the level of prosperity achieved. This happens because of unemployment can lead to real national income (real) reached the public will be lower than the potential revenue (revenue that should be). Therefore, prosperity achieved by the public will be lower.
- Unemployment will cause national income derived from reduced tax sector. This happens because of high unemployment would cause the declining economic activity so that the public revenues will decline. Thus, the tax must be paid from the public would be decreased. If tax revenues decline, government funding for economic activities will also be reduced so that the development activities will continue to decline.
- Unemployment does not promote economic growth. Unemployment will be turned on causing people's purchasing power will be reduced so that the demand for goods production will be reduced. Such circumstances do not stimulate the Investor (employers) to perform the expansion or establishment of new industries. Thus the growth rate of investment declined resulting the economically unaccelerated, thus the growth of the organization is not running as expected

#### **b. The impact of unemployment on individuals who experience it and Society**

The following is the negative impact of unemployment on individuals who experience it and to society in general:

- Unemployment can eliminate livelihood
- Unemployment can eliminate skills
- Unemployment will lead to social and political instability.

#### **4.6. The role of education in economic growth in Indonesia**

Human capital theory to explain the process by which education has a positive effect on economic growth. Nobel Prize winner Gary Becker economics from the University of Chicago and Edward Denison and Theodore Schultz argue about the theory of human capital. Arguments supporting this theory is humans who have higher education levels, as measured also by the length of time the school will have jobs and better wages than with lower education. If wages reflect productivity, the more

people who have a higher education the higher the productivity and the results of the national economy will grow higher.

Some other arguments presented is the level of education does not always match the quality of work, so that people who are highly educated or low productivity did not differ in dealing with the same job. This argument is also corroborated that the era of technology workforce has high expertise is not so necessary anymore because of rapid technological development and the production process can be simplified further. Thus the low-educated people but received training will have the same relative productivity with highly educated people and formal. This status competition theory treats education as a social institution which one function socially allocate personnel according to educational level.

The need to reach a higher status leads people to take higher education. Although people are more educated have a higher proportion of the national income, but an increase in the proportion of higher educated people in a nation will not automatically increase or expansion of economic growth. Growth theory class or social strata argued that the primary function of education is to develop the class structure and social imbalances. Education in the elite group emphasizes the study of the classics. Of the several theories on where the course will be more relevant. The theory of human capital refers to the stock of knowledge and skills to produce someone. Education is one way in which individuals improve their human capital. The higher someone's education, the higher expected for human capital stock. Therefore, human capital, as stated above has a positive relationship with economic growth, then the implication of education also has a positive relationship with productivity or economic growth.

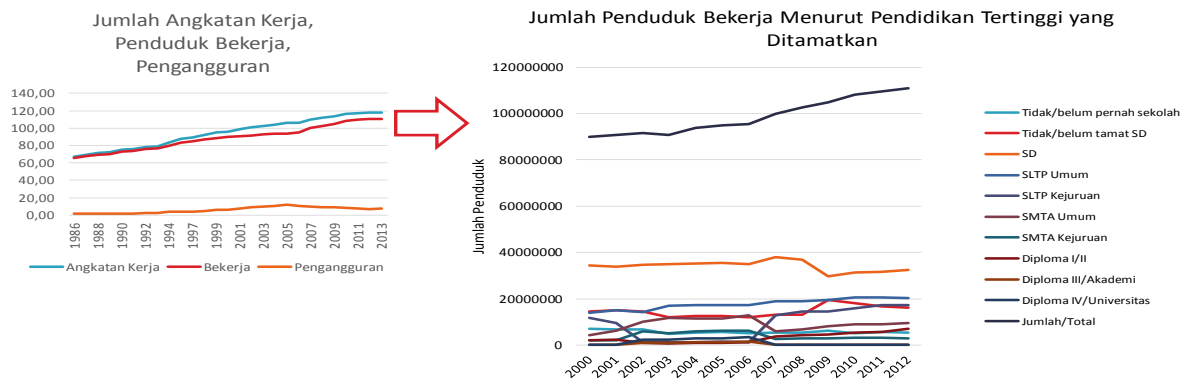
Education implicitly accounted for in the excavation of knowledge. Knowledge not only of education but can be obtained through the development of ideas and research. So it can be said that education has a role in economic growth due to education through formal and non-formal will generate productivity, with high productivity growth of a country will affect the growth of the national economy. The role of education and economic growth has a close relationship in which both components of these institutions are state assets that require careful management. In particular relationship involves physical capital, labor and technology advances into three principal factors as input (inputs) in the production of national income. The greater the amount of labor (which means high population growth rate) the greater the higher national income and economic growth, the data showed:

From the above data shows that the product of the institution as a producer of the product of labor is not maximized, in this case can be seen from the data condition of unemployment in Indonesia, in 2014 there were university graduates still have not absorbed in the labor force. The above data indicate that the competency of the lower product education institutions. From the results of the National seminar UT theme "shows that productivity and labor expertise in Indonesia is still very low, so it cannot compete with workers from other countries. Institutions in Indonesia should improve the performance and quality of the resulting education, because education is the product of the graduates who AKN absorbed in the world of work. An organization will experience good growth if it is supported by the human resources competencies reliable.

The data also showed that the level of educational equity is still not evenly mention it can be seen from the number of Indonesian people who drop out of school.

Some of the data below can be studied further:

## Kondisi sumber daya manusia di Indonesia saat ini belum siap untuk berkompetensi di Masyarakat Ekonomi ASEAN



**Keterangan:**

Jumlah penduduk bekerja mengalami peningkatan dari tahun ke tahun, seiring dengan peningkatan jumlah angkatan kerja. Menurut pendidikan tertinggi yang ditamatkan dari penduduk bekerja, lulusan SD adalah yang paling mendominasi. Sedangkan dua urutan jumlah paling sedikit adalah lulusan Diploma III/Akademi dan Diploma IV/Universitas.

Source: KMS Economic Faculty Kalbis Institute

From the above data shows that the low level of education of Indonesia which have an impact on economic growth in Indonesia.

### 4.7. The role of economic growth in the success of the business strategy

Economic factors include economic growth of a country and things related to the macro economy, such as inflation, government policies and others. These factors evolve and micro economic impact to the more specific. These factors will affect the global corporate policies in deciding a direction and move the company (corporate strategy).

When will the economic growth will affect the business strategy, namely in the event of changes in economic conditions around the company, the company's strategy should be changed. Economic growth will affect the overall business strategy means that every part of a company will feel the impact on economic growth. How economic growth will affect the business strategy, economic growth of a nation's health will affect the strategy of a company which impact on company performance. What strategies should be required companies must learn to identify changes in the economic environment, trends, and implications strategik. Semakin increasing interdependence of the world economy is increasingly realizing the importance of all countries to create a global market and the company must have innovation and utilize existing resources as much as possible

Economic growth factors have a direct impact on the potential of the business strategy. If interest rates rise, the funds are used for expansion becomes more expensive, causing the price of a product increases, consequently the value of revenues down and eventually purchasing power will decline

Central Bureau of Statistics presents data that in 2013 the labor force is 66.90% (118.19 million), while the data show that the unemployment rate still reached 6.25% (7.39 million people) of the total labor force is 118.19 million people in Indonesia. These data indicate that all the work has not been absorbed service branch so that there are about 7.39 million people unemployed in Indonesia. By looking at the percentage of the unemployment rate still will affect the economic growth of one of them will affect the per capita income.

Here is the per capita income data Negara Indonesia:

Capital Income ASEAN 2011		
No	Negara	Dalam US \$
1	Singapura	57,238
2	Brunei Darussalam	47,200
3	Malaysia	14,603
4	Thailand	8,643
5	Indonesia	4,380
6	Philippines	3,725
7	Vietnam	3,725
8	Laos	2,435
9	Kamboja	2,086
10	Burma	1,900

The low per capita income of the Indonesian state will affect the business growth that will impact on business strategy will be applied.

## CONCLUSION

1. The company will sustain if the company has a strong HR strategy, it is shown by the competency of the workforce in the company, Innovation always comes from the company that have a high competitive advantage.
2. The gap between the industrial world and the world of education are:
  - Graduates do not have the competencies expected by the industry
  - Graduates can apply the theory learned in college with a real job
  - Graduates do not have enough character
  - Graduates do not have leadership skills
3. Organizations and companies in Indonesia will face several problems including the quantity and quality of the labor force. Facts show that:
  - In 2020 the companies will not be able to meet the needs of entry-level positions with good quality candidates.
  - 55% work in Indonesia would be an administrative or managerial, compared with the current 36%.
  - Indonesia has not been able to produce qualified graduates to fulfill the position.

The lack of quality for human resources in Indonesia significantly will have an impact for the continuous improvement of Indonesian populations, because the more competent the human resources will affect the competitiveness.
4. The theory of human capital refers to the stock of knowledge and skills to produce human resources. Education is one way in which individuals improve their human capital. The higher a person's education, human capital stock is expected to be higher. Therefore, human capital, as stated above has a positive relationship with economic growth, then the implication of education also has a positive relationship with productivity or economic growth
5. Education has a role in economic growth due to education through formal and non-formal since it can generate productivity, with high productivity growth of a country will affect the growth of the national economy
6. Economic growth will affect the business strategy, namely in the event of changes in economic conditions around the company, the company's strategy should be changed. Economic growth will affect the overall business strategy means that every part of a company will feel the impact on economic growth. How economic growth will affect the business strategy, economic growth of a nation's health will affect the strategy of a company which impact on company performance
7. The low per capita income of the country of Indonesia will affect business growth will impact on business strategy to be applied

## MANAGERIAL IMPLICATIONS

1. The organization should have a standard of excellence which covers of human resources competencies consisting of Knowledge, Work Ethics and Expertise
2. The graduates should be equipped with the competencies that can be useful for the industrial workplace or any workplace fitted with their competencies, would be better with qualified certificate.
3. Indonesia should increase the income per capita through increasing the Gross Domestic Product
4. Indonesian comparative advantage should be used for the welfare of the people- Indonesian populations.

## **BIBLIOGRAPHY**

BPS-RI, Susenas 1994-2013

Barney, Jay B; Hesterly William, S. (2008), *Strategic Management and Competitive Advantage*, 2nd Edition, Pearson Prentice Hall

Collis, D & Montgomery C (2004) *Corporate Strategy, A Resource Based Approach*, 2nd ed

Kay, Jhon (2011) *Think Again : Summer 1993 The structure of strategy*, *Business Strategy Review*, Vol 22 (2) – Jun I, 2011

Kaplan, RS and DP Norton (1992), *The Balanced Scorecard: Measures that Drive Performance*, *Harvard Business Review* (January – February): 71-79

Wheelen, Thomas ; hunger, David J (2010), "Strategic Management and Business Policy, Achieving Sustainability" policy, 12 ed, Pearson

Emerson Wagner Mainardes ; *Strategy and strategic Management concepts : are they recognised by management students*

Eko Wicaksono Pambudi; *Analisis pertumbuhan ekonomi dan faktor-faktor yang mempengaruhi CISCO; Education and Economic Growth*

Yesi Hendriani Supartoyo; *The Economic Growth and the regional characteristic : the case of Indonesia*

## **ACKNOWLEDGEMENT**

Humble gratitude to Allah SWT, to Almighty God that authors could finish this paper. Thank you for family, relatives, and colleagues for the support. And lastly for Kalbis Institute, Bravo Kalbis. Education for a better life.

# A Study of Entrepreneurship Development in Bangladesh: Pros and Cons

<sup>1</sup>Fatema Nusrat Chowdhury

<sup>1</sup> lecturer, Department of Business Administration, Faculty of Business and Economics, Daffodil International University, Dhaka-1207, Bangladesh, nusrat.bba@daffodilvarsity.edu.bd, +8801680228933

## Abstract.

This study aims to explore the opportunities which encourages people to become entrepreneurs, in microcosm such extensive constrains related to growth and development of entrepreneurship in Bangladesh. The paper is covered by secondary data collected from research article, monographs, cases and various published materials on the subject. The findings indicated that new scope and existing opportunities for entrepreneur from the government, socio-cultural perspective, natural deposit. The outspread list of constrains and problems of entrepreneurship development include personal, environmental- situational, judicial, economic and political. The study also refers some suggestions for utilizing the opportunities overcoming those constrains for entrepreneurship development in Bangladesh.

**Keywords:** *bangladesh, constrain, entrepreneurs, entrepreneurship, entrepreneurship development, opportunity, problem, small to medium-sized enterprises, social entrepreneurship.*

## 1 Introduction

An entrepreneur is the person with the initiative to form a business with his dexterity of creative thinking. S/he is consistent to develop an enterprise being independent, self motivated and industrious. S/he retains all the factors of production and reassembles the thinking to produce something new in the society. Being a risk taker, entrepreneur develops a business entity for the betterment of the country as a whole. According to Butt (1988), entrepreneur being the front line actor with his vigor, ability and ingenuity makes for a modification in the socioeconomic order by the cognitive operation of industrial growth. Moreover, ILO identifies the entrepreneur with a set of characteristics, including risk taking, leadership, originality, self confident, result oriented and future oriented. On the other hand, entrepreneurship blends the capacity of innovation, investment and expansion in productivity. Qualities of entrepreneur results in terms of entrepreneurship. Schumpeter (1939) defines that entrepreneurship consists of purposeful and systematic inventiveness. Again he (1955) added entrepreneurship as a creative activity lead an entrepreneur being innovated to introduce something new in the society. This entrepreneurship is the act of self-motivation, originality, resourcefulness, imagination, ingenuity to setting up a new venture in a society with uncertainty (Rahman, 1945). Entrepreneurship development is the process to integrate all the entrepreneurial qualities- confidence, commitment, hardworking, flexible, persistence, independence, determination, initiative, versatile, perceptive, leadership, innovativeness, profit oriented, foresightedness, creativity. Furthermore, Sharma (1979) narrate this development process depending on multiple factors, by the integrated package programs, including (i) Stimulatory programs, (ii) Supportive programs and (iii) Sustaining programs.

## 2 Literature Review

A solid number of written reports on entrepreneurship have been conducted at home and overseas. A brief recap of some subjects is given below: the entrepreneur, in Scheumpeterian model, is an innovative entrepreneur, who depends on assertive social and economic overheads. The economic and social expenses are really poor in backward area, which result the low supply of entrepreneurs (Schumpeter, 1954). McClelland (1961) took a sketch of the achieving society and found that initiators could be entrepreneurs as they bear a high demand for accomplishment. The McChelland's hypothesis is that a community with a generally high degree of achievement motivation will create more rapid economic growth. The inner need of the individual to do something novel, something antic in a specific field has been set up to be a significant component. It consists entrepreneurial motivation, efficiency and capacity. Achievement inspiration and power motivation are as imperative for



entrepreneurship (McClelland and Winter, 1969). Morris and Somerset (1971) expressed that increase in the range or interaction is needed and the barriers to interaction must be going down if entrepreneurship is to come. According to Hossain (1963) the entrepreneurs in Bangladesh own sufficient intelligence and ingenuity to make advantage of feasible business opportunities. Rahman (1979) critically evaluated the impact of different programs and policies relating to entrepreneurship and small enterprises. The determinants of entrepreneurship development are constructed along the socioeconomic conditions of a state. Nevertheless, foreign students who ever studied the socioeconomic and ethnic context of Bangladesh appear to think that Bangladesh has youths with potentiality to be trained as entrepreneurs (Habibullah, 1985). Habibullah (1987) conducted another research on entrepreneurship training and development and revealed that training is an efficient tool for entrepreneurship development in Bangladesh. Chowdhury (1980) carried a survey on the emergence and increase of entrepreneurs in some developing states and found that over the last several years, some developing countries recorded spectacular growth and success of small entrepreneurs. Davies (1991) focused the urge for achievement as the cause that inspires people to be entrepreneurs and venture into advanced and productive initiatives enhancing economic development. Chowdhury (1992) opinions that it is rightful that a congenial environment is essential to prepare and develop effective entrepreneurs in the state. Rahman (1993) noted that the poor economy of Bangladesh can hardly afford entrepreneurship development other than in small-scale ventures. In fact, a balanced development of the economic organization is largely contingent upon small scale enterprise for a good many reasons like huge unemployment, technological backwardness, poor infrastructural framework and scarcity of capital. Aktaruddin (1999) observed that personal attributes are key factor for entrepreneurial success of failure, while Aktaruddin (2000) reported on the socioeconomic background of the entrepreneurs. Salman (2000) indicated some external and internal factors or barriers to develop the SME sector, as information, knowledge, political, economic, legal organization, government publications, engineering, natural weather, which can be classified as external elements and machinery, structure people or materials and process as internal components. Salman (2000) carried a research on impediments to MSE development and found that still there is a gap of awareness about new era and e-commerce. Hasan and Rahman (2001) identified that approach to finance is the most important problem for SMEs as commercial institutions typically ignores the fiscal demands of the SMEs initially due to their weakness in providing fixed asset as collateral. Islam and Aktaruzzaman (2001) found that 76.3 percent of the rural entrepreneurs had no education at all, of which nearly 17 percent could neither say or write and another 59.3 percent were only able to invest in their signature. Costly time taking regulatory system with licensing and permitting has been planted as a roadblock for the SME growth development by the SME department's country mapping research and study. George and David (2003) conducted a survey in providing lower expensive IT approach to rural areas in developing countries and revealed that weak data structure, just like weak transportation infrastructure, can reduce the attractiveness of merchandise business with particular countries. Roni (2003) reported that the availability of capital is not enough in Bangladesh due to the precarious financial environment and per capital income is low as USD220. The interest rate is high that lead cost of bowing also high. The wage rate is the most important determinant of entrepreneurial decision. Besides this Roni stated that he entrepreneurship in the political division of Bangladesh is not adequately supported. World Bank SME department states gap of the legal framework for commercial dealings and dispute settlement is the major impediments to the development of the SME sector. Roni (2003) revealed that in the long run socio-cultural environment plays a far reaching effect in the entrepreneurs. The survey also claimed that entrepreneurs can engage from socially marginal class, like ethnic, religious culture or migrant minority. Many writers have focused on social integration factors. Islam and Aktaruddin (2003) carried a survey on rural development in Bangladesh and found that out of total 120 rural entrepreneurs, 75 percent faced a marketing problem. Roni (2003) viewed that the growth of entrepreneurship development results from certain environmental factors and some economic factors. Mittal and Batra (2004) ran a study on the factors bearing on the growth of entrepreneurship development in small scale industries in Panjab and Haryana and noted that with globalization, the small-range entrepreneurs are facing an intense competitor. Rahman and Das (2005) carried a research on the evolution of SMEs in Bangladesh and vowed that unfair use of political power is liable for the imperfect market. Thus, real entrepreneurs are depressed in terms of inaccessibility to a specific business. Rahman and Das (2005) considered that Government with NGOs and international development agencies must take proper steps to address entrepreneurship. Granting to the Centre for Policy Dialogue (CPD), costly infrastructure like power, energy, water and transportation, high rate of interest is the significant troubles of the SME sector and it is doing business difficult and non viable in competition.

### **3 Justification of the Study**

This paper leads to optimize the available opportunities along with the recovery of problems and constraints by achieving the following advantages of entrepreneurship development in Bangladesh. Our country is spilling over with numerous unemployed people with potentiality in the periphery. By certifying entrepreneurship development in Bangladesh we can ensure industrialization, capital formation, market formation, innovation, balancing wealth distribution with marginal development, innovative product and services, GDP growth, balance inflation, the balance of trade, balance of payment, increasing living standard and certainly maximum utilization of natural resources using technology.

### **4 Objective of the Study**

The ruling focus of this study identifies the pros and cons (pro et contra) of entrepreneurship development in Bangladesh. Precisely the study attempts to attain the following objectives:

- To classify the problems and constraints faced by the entrepreneur of Bangladesh.
- To scrutinize the availability of scope and opportunities for expansion of entrepreneurship development in Bangladesh.
- To propose some recommendation to remove those obstacles by utilizing the opportunities for the growth and development of entrepreneurship in Bangladesh.

### **5 Methodology of the Study**

In order to carry on this work and to find out the opportunities and problems that will be quantitative in nature, descriptive research design has been tackled. The present work is largely constructed out of secondary information. Relevant and supporting secondary data have been collected through desk study, including research articles, texts, research monographs, cases and various published and unpublished materials on the topic. These data have been examined to establish the study more enlightening and thought stimulating.

### **6 Scope and Opportunities**

As a potential developing country, Bangladesh has immense opportunities to develop entrepreneurship. Through (Sharma 1979) the integrated package programs this study explores the opportunities in following categories of (i) Stimulatory opportunity, (ii) Supportive opportunity and (iii) Sustaining opportunity available from government and secret governance.

#### **6.1 Stimulatory Opportunity**

The opportunity to self-stimulate toward the entrepreneurship development plays a important part in the guild. The stimulatory activities comprise the scope for entrepreneurs, role play, entrepreneurial education and natural resources required to uphold emergence of entrepreneurship in Bangladesh. These programs ensure the increasing number of supply of entrepreneurs to initiate a new business entity and develop potentiality to lead the venture. The opportunities from diverse origins are discussed infra:

##### **6.1.1 Publicity for Immense Entrepreneurial Scope and Identifying areas of functioning**

Our rural area needs lots of entrepreneur to flourish the GDP growth using potential operational areas. At that place are immense entrepreneurial scopes for newbies to startup their enterprise. Business revolution can be accomplished by a workout in following fields. IT based business like e-commerce, f-commerce, software development company; agriculture based business like honey bee, food preservation, mushroom cultivation, juice; farming business like poultry farming, cattle rearing, fishing, alligator farm; firming like nursery, horticulture, tree plantation, bamboo cultivation; beautification based business like interior, exterior design, furniture, painting, cane work; boutique business like parlor, embroidery, tailoring, fashion house; small scale engineering like glass blowing business, ceramic tiles business, light engineering, ship building and breaking; housing business like real estate, land brokerage; tourism and recreational sector; consultancy and advisory firm; training

institution like human skill development institution, educational institution, technical and handicraft training.

### **6.1.2 Role Play and Traditions lead to entrepreneurship**

Bangladesh is abundant with successful entrepreneurs, charismatic, intelligent leaders and industrious workforce, named as Ranoda Prasad Saha, Jaharul Islam, Chaitta Ranjan Saha, Samson H Chowdhury, Fazle Hasan Abed, Dr. Mohammad Yunus, Salman F Rahman, Abul Kashem Khan, Sheikh Akijiddin, Sabur Khan, Saleh Ahmed Chowdhury, Anowara Begum, and so no. In our country business moves in next generation from their forefather. Thus, there are some traditional business practices like family traditions, regional tradition, historical tradition, following transistors. These customs may lead to revolution in entrepreneurship in Bangladesh.

### **6.1.3 Availability of Natural Assets**

Bangladesh is enriched with the deposit of natural resources. We can classify the available natural capital in following categories: factors of production list fertile land, cheap & hard working human resource, provisions for financing facility, fully recharged entrepreneurs by tradition; mine ore compresses natural gas, mine coal, glass, silicon, stone etc.; Communication ways are sea port, river ways, airways, railways and by road facilities.

### **6.1.4 Positive and Independent Attitude by Nature**

By nature the people of Bangladesh are independent, self motivated, innovative. Moreover the lead taking personality, industrious nature, risk taking attitude, creative thinking, cooperative, finally competitive aspiration boost up the entrepreneurial quality. All these attributes comprise the entrepreneurs of Bangladesh as a whole.

### **6.1.5 Educational inspiration**

In Bangladesh both general education and technical education contribute to the entrepreneurship development. In general education, students get introduced to entrepreneurship in the secondary level and remain thereon to develop the preliminary background for start-up initiate in the business field. The academic curriculum introduces the student with the prominent business entrepreneurs of Bangladesh. Recently The University Grants Commission (UGC) of Bangladesh has approved the bachelor degree in this specified area and the Daffodil International University has commenced a Bachelor of Entrepreneurship Development (BED) Program focusing on the opportunity to gather knowledge and skills which will help them flex their minds into becoming a successful entrepreneur. BED program is mainly focused to guide students as a mentor so that they can move through the process of starting up a venture in order to become an entrepreneur. Then, this program is suitable for those who dream to launch a venture and become a successful entrepreneur. A bulk of the country-known entrepreneurs and leading academicians will offer this class through the mixing of both theory and practical exposure. Moreover, worldwide exposure has been projected with the assistance of foreign universities. Bachelor of Entrepreneurship Development Program aims at producing graduates equipped with entrepreneurial skills, cognition, values and attitudes for their jobs. After successful completion of this course of the survey, alumni will be capable to transform themselves not only as self-employed but also as creator of employment through becoming an entrepreneur. On the other hand, technical education highlights three levels of programs-Certificate, Diploma and Degrees to demonstrate the growth of entrepreneurship in Bangladesh.

### **6.1.6 Motivational training for young entrepreneurs**

At that tip is some motivational training, providing institutions available for newbies in entrepreneurs of Bangladesh. They mainly focus on the startup techniques, savings and motivational aspects of business entity. Moreover, they verbalize the way to acquire resources, logistics support, financial support needed for an enterprise setup from various supportive organizations.

### **6.1.7 Availability of entrepreneurial firm**

At that place are some entrepreneurial forums to stand beside the new entrepreneurs. Moreover, some universities are working for entrepreneurial integration for their student like social business

center with a daffodil international university, UIU entrepreneurship forum, NSU Business Club, AIUB business club. The Bangladesh Youth Leadership Center (BYLC), United Nations Youth and Students Association of Bangladesh (UNYSAB) and Forum of entrepreneurship and business (FEB) are also working for strengthening student in the business field. These forums induce mainly the inspiration among the entrepreneurs.

## **6.2 Supportive Opportunity**

The support programs usually empower the entrepreneurs in starting up and ruling the enterprises successfully. They help in reassemble resources and supportive provision of entrepreneurial scope and mentoring in selecting industries. The supporting aspects are specified at a lower place:

### **6.2.1 Financial Support**

Entrepreneurs of Bangladesh get direct and indirect favorable support from the financial sector by the way of entrepreneurship development policy. Bangladesh Bank is the most leading contributor of the financial sector through financial assistance, interest free loan, micro credit facilities, collecting foreign aid, subsidy and various ways for young entrepreneurs.

### **6.2.2 Logistic Support**

Logistic support plays an important function in the industrial sector for entrepreneurs by getting special consideration for investment in the BSCIC industrial area, EPZ, BEPZA. These actions contribute to, encourage investors by infrastructural support, cheap transportation facilities, land port access, communication facilities etc.

### **6.2.3 Technological Support**

Bangladesh being a digital country focuses implementation of IT in every sphere of business. So entrepreneurs are no longer free from IT support. Technical Support includes IT facility, scientific study and engineering universities, R&D organizations, breeding and development program by IT specialist institutions, and hence along.

### **6.2.4 Available Supportive Organization**

There are a number of organizations specialized in entrepreneurial assistance both in the government sector and government supported private organizations. Government organizations include Board of Investment, Bangladesh Development Bank (BDB), Bank of Small Industries and Commerce (BASIC), Investment Corporation of Bangladesh (ICB), Government, Commercial Banks, Rajshahi Krishi Unnoyon Bank, Bangladesh Krishi Unnoyon Bank, Controller of Export and Import, Bangladesh Standard and Testing Institute (BSTI), Bangladesh Council of Scientific and Industrial Research (BCSIR), Industrial promotion and Development Company of Bangladesh (IPDCB), Export Promotion Bureau (EPB), Trading Corporation of Bangladesh (TCB) etc. On the other hand, the Government supported private organizations are Private, Commercial Banks, Private Insurance Company, Grameen Bank, Industrial Development leasing Company of Bangladesh Ltd. (IDLC), United Leasing Company (ULC), Saudi Bangladesh Industrial and Agricultural Investment Company Ltd. (SABINCO), The Bangladesh German Chamber of Commerce & Industry (BGCCI), Bangladesh Women Chamber of Commerce & Industry (BWCCI), Women Entrepreneurs Association, The Federation of Bangladesh Chamber of Commerce and Industry (FBCCI), Dhaka Chamber of Commerce & Industry (DCCI), Proshika, Bureau of Manpower Employment and Training (BMET) etc.

### **6.2.5 Training program**

Bangladesh Government is also controlling and supporting many organizations to conduct the entrepreneurship training program. The training organizations are Bangladesh Small and Cottage Industries Corporation (BSCIC), Bangladesh Rural Development Board (BRDB), Directorate of Women, Bangladesh Institutions of Management (BIM), Micro Industries Development (MIDAS), Youth Development Training Centre, Bangladesh Industrial technical Assistance Centre (BITAC), Bangladesh Rural Advance Committee (BRAC) and so on.

### **6.2.6 Other Supports**

Furthermore, entrepreneurs get other support like granting tax relief, help in marketing products, offering management consultancy and etc. from assistance organizations.

### **6.3 Sustaining Opportunity**

The sustaining programs include motivations which uphold the entrepreneurs to sustain themselves toward the barrier of actual performance. Want of self inspiration may lead the enterprises meet immature death. As a consequence a number of business entities slop downward with GDP falling. Thus modified policy, motivational assistance, promotional factors can regain the lost inspiration in entrepreneurs. Some of these options are discussed below:

#### **6.3.1 Favorable Policy**

Entrepreneurship development policy formulates some policy for support to favor the young entrepreneur not to pitch down in their inspiration toward business. Tax holidays, balance development policy, rural development policy are directed to encourage entrepreneurial in finding new scope for commercial enterprise.

#### **6.3.2 International Promotional Factors**

In the epoch of globalization, Global village strategy opens the door to admission in foreign grocery store. Flexible international trade factors may emerge the growth of entrepreneurship development in Bangladesh.

#### **6.3.3 Women Entrepreneur Assistance**

Bangladesh Women Chamber of Commerce & Industry (BWCCI) along with Joyeeta Foundation under the program of "Development Efforts of Women Entrepreneurship" of Department of Women Affairs. This is a vital step of the government to open access to market for the merchandise which is raised by the remote area's women's association of Bangladesh. At present 180 entrepreneurs are being provided with 140 stable. Disabled and oppressed women entrepreneurs are also provided with stalls. With the persuasion to market products and services acquired by small women entrepreneurs scattered in almost all parts of the rural area, attempts have been taken by Joyeeta to build women entrepreneur-friendly institutions. This will propagate pace of the growth of women entrepreneurs; more work opportunities for women will be created; discrimination between human races and adult females will lose weight. Moreover, Women Entrepreneurs Association plays a vital role in making united collaboration of women entrepreneurs of Bangladesh. Without women empowerment, entrepreneurship development of Bangladesh cannot move upward. Supremely, women empowerment added with poverty alleviation in the rural area will gradually take place.

#### **6.3.4 Motivational Assistance**

Motivational assistance like establishing social recognition and providing consultancy for commercial enterprise and industries, offering rewards and awards, arranging the advisory program and, setting quota facilities to enter in free trade market, arranging favorable program, providing government patronization to create awareness for entrepreneurship.

#### **6.3.5 Other Sustaining Assistance**

Moreover, entrepreneurs get other sustaining assistance like help in business expansion through diversification; additional financing, facilitating quality testing, and assist with re-engineer products or services in additional market and etc. from assistance organizations. This sustaining assistance works best on failure stage of entrepreneurs.

## **7 Problems and Constrains**

Bangladesh is being abundant with lots of scope and opportunities for young entrepreneurs, lagging behind in the outspread list of constraints and problems of entrepreneurship development in following aspects:

## **7.1 Exclusive Factors**

Backward position in entrepreneurship development indicates the mental elements, conceptual factors, efficiency factors and managerial components. Mentality factors consist of backdated, avoidance, risk averse, conservative mental traits. Conceptual factors define lack of originality, courage, business knowledge, managerial experience and forecasting skill. Efficiency factor is the gap in entrepreneurship due to lack of talent, training, selecting power workforce. Finally, managerial factors combine unavailability of expert management, proper preparation and operating strategy.

## **7.2 Coincidental-Situational Factors**

Marketing factors, risk factors, infrastructural factors technology factors combine the Coincidental-Situational Factors. Marketing factors indicate failure of market strategy, lack of fair competition, unstable market conditions, and unfair practices. Risk factor includes high risk with a low yield problem, losing social status, sole responsibility and uncertainty in raw material supply. Infrastructural factors are non developed roadside, expensive airways, risky transportation system, lack of fuel and costly energy supply. Technology facts indicate the unavailability of IT facility in the fringe.

## **7.3 Legislative and Bureaucratic Factors**

The legal system along with political issues head to increase constrains in entrepreneurship development by policy making factors, political agents, international factors and corruptions. While making policy some issues come in front not taking attention of entrepreneurs, like difficulty in licensing, copyright barriers, political instability, harassment, risk of life indicate political factors in the roadblock. Moreover, there is practice of corruption as a means of administrative blockage, biases, bribery issue.

## **7.4 Economical Factor**

The economic condition of Bangladesh sometimes negatively influences the development process of entrepreneurship. The drives are high inflation, unemployment issue, complex loan granting process, restrictive credit policy, unusual market structure, crisis of emergency fund and infrastructural lacking.

## **7.5 Other constrains**

Furthermore, entrepreneurs get other constraints like absence of proper policy decision, lack of proper financial support, lack of awareness of incentives offered by the government, lack of campaign about areas of entrepreneurship, lack of proper training facilities of entrepreneurs, lack of integrated computer software assistance, stimulating, supportive and sustaining activities needed for SMEs.

## **8 Recommendations**

Bangladesh with immense prospect for entrepreneurship development can flourish the scope across national boundary line by recovering the constraints faced by entrepreneurs. At that place are some following recommendations to tradeoff the problems with opportunities:

- The government should acquire a practical and implacable policy for entrepreneurship development, focusing on decentralization, rural development and protect domestic entrepreneurs.
- Social entrepreneur can be targeted by social business concept merging with entrepreneurship development. In the long run, it will result in social benefit with a huge increase in national entrepreneurs.
- Educational funding for entrepreneurship development in the undergraduate level specially the Bachelor of Entrepreneurship Development (BED) should be emphasized by Universities.
- More competition based award-reward program like HSBC young entrepreneur awards, Battle of Mind by British American Tobacco, The Future Leader etc. for inspiration and social recognition to young entrepreneurs should be established by national private companies.
- Entrepreneurship Development Policy (EDP) should integrate assistance in three categories of program, including (i) Stimulatory programs, (ii) Supportive programs and (iii) Sustaining

programs by ensuring political stability, removing legal complexity, strengthening the developing program, stimulating and patronizing privatization, ensuring transparency and just practice in market strategy, increasing logistic and infrastructural support.

- Government should provide re-enforcement package for failure entrepreneurs by arranging required finance for new startups, granting tax relief, facilitating quality testing, help in re-engineer products or services in additional market, offering management consultancy and etc.
- Non government organizations should implement their actions by increasing research publication on entrepreneurship
- Both government and non-government organization should ensure investment consultancy with counseling, seminar, workshop, camping to influence newbie in entrepreneurs' world.
- Entrepreneurial forums should enrich the collaboration of existing potential entrepreneurs with young innovators to expand knowledge on Business.

## 9 Concluding Remarks

This subject has tried an attempt to explore the problems and opportunities of entrepreneurship in Bangladesh. As a producing nation, Bangladesh has extreme range for the evolution of entrepreneurship. With the help of integrated package programs, including (i) Stimulatory programs, (ii) Supportive programs and (iii) Sustaining programs, the study has identified legal facilities, financial facilities, logistic supports, technical and technological assistance, availability of natural capitals, training and educational assistance, providing by both government and non government organizations, facilities from socio-cultural prospect, traditional role play personals, international factors, favorable policy and boundless scope for selecting operational area for business. This study also pinpointed constraints and problems in the growth, development of entrepreneurs which are categorized in personal, environmentally-situational, legal- political and economic causes. The identified factors consist of mentality, conceptual, efficiency, managerial, marketing, risk, infrastructural, technological, policy making, political, international, corruption, inflation, crisis of emergency fund, insufficient financial organization, complexity in loan granting, restrictive credit policy, unstable market structure, Infrastructural backwards, absence of proper policy decision, lack of proper financial support, lack of awareness of incentives provided by the government, lack of campaign about areas of entrepreneurship, lack of proper training facilities of entrepreneurs, lack of integrated package assistance, stimulating, supportive and sustaining activities needed for SMEs and so on. By following proposed recommendation, identified problems and constraints may be halted by utilizing named scopes and opportunities to boost entrepreneurship development of Bangladesh. This work is just elbow grease in the plot of entrepreneurship development in Bangladesh but further research should be pursued to achieve the higher growth of entrepreneurship.

## 10 References

- Ahmed, K. F. & Ali, Md Hazrat. (2013). Entrepreneurship Development in Bangladesh: Opportunities and Problems. *Dhaka Commerce College Journal*, V(1), 111-126.
- Aktaruddin, M. (1999). A Case Study of Some Successful and Unsuccessful Entrepreneur in Bangladesh. *Journal of Business Administration*, 22, 89-126.
- Aktaruddin, M. (2000). Socio-Economic Profile of Industrial Entrepreneurs: A Study on North Region of Bangladesh. *A Journal of Banking and Finance*, 25, 39-53.
- Begum, R. (1993). Entrepreneurship in Small-Scale Industry: A case Study of Engineering Units. *Dhaka Journal of Business Studies*, 14, 159-162.
- Butt, K. A. (1998). Small Entrepreneurial Education: Approach and Methodology. *Abhigyan, Fore School of Management*, New Dehli, 17(4).
- Chowdhury, Abdul Mannan. (1980). The Emergence and Growth of Entrepreneurs in Some Developing Countries. *The Dhaka University Studies*, 9(1).
- Chowdhury, A. J. M. Nuruddin. (1992). Problems of DFI- Financed Entrepreneurs in Bangladesh (K. A. Nabi ed), *Development Finance Institutions of Bangladesh: Policy, Performance, Problems and Prospects*, Dhaka: goeth- Institute.

- Darzi, M. A. (2004). Strategy for Entrepreneurship development. *The Business Review*, 11(1), 67-72.
- Davies, S. P. (1991). The Entrepreneurial Search for Capital: A behavioral Science Perspective *Entrepreneurship and Rural development*, 3, 237-252.
- George, C & David, C. (2003). Providing Low Cost Information Technology Access to Rural Areas in Developing Countries. OECD Development Centre OECD Working Paper, 229.
- Habibullah, M. (1985). *Entrepreneurship Training and Development* Chittagong University: Bureau of Business Research.
- Habibullah, M. (1987). *Entrepreneurship Training and Development* Chittagong University, Faculty of Commerce, Bureau of Business Research, 47-58.
- Habibul Rahman, A. H. M.; Muhammad Ali Mian; Durgadas Bhattacharjee; & Azizur Rahman Khan (1979). *Entrepreneurship and Small Enterprise Development in Bangladesh* Dhaka: University of Dhaka, Bureau of Business Research.
- Harbison, Fedrick. (1956). Entrepreneurial organization as a Factor in Economic Development. *Journal of Economics*. LXX(3).
- Hasan, M & Rahman, T. (2001). Problem of Managing Small and Medium Enterprise in Bangladesh. *Journal of Banking and Finance*, 26, 5-23.
- Hossain, A. F. A. (1963). *Pakistan in the Role of Saving and wealth in Southern Asia and the West* (Richard D. ed) Lambert and Hoselitz, UNESCO, Paris.
- Hossain, K. S. & M. Rahman. (1999). Role of Grameen Bank in Entrepreneurship development: A study on some Selected Entrepreneurs. *Islamic University Studies*, 2, 7-13.
- Islam, Saiful Md. & Md. Aktaruzzaman. (2001). The Problem of Rural Women Entrepreneurs in Bangladesh: A Case Study of Jhenaidah District, *Islamic University Studies*, 4(1), 19.
- Karim, N. A. (1996). *Need Assessment Survey of Existing and Potential Women Entrepreneurs* Dhaka: Women Entrepreneurs Association.
- McClelland, D. C. (1961). *The Achieving Society* Priceton, NJ: Van Nostrand, 23.
- McClelland, D. C. & D. G. Winter. (1969). *Motivating Economic Achievement* New York, The Free Press.
- Mittal, K. C. & Batra G. S. (2004). Factors Affecting the Growth of Entrepreneurship in Small-Scale industries in Panjab and Haryana. *The Business review*, 11(1), 98-104.
- Orpen, C. (1993). Strategic Planning, Scanning Activities and the Financial performance of Small Firms. *Journal of Small Business and Entrepreneurship*, 11, 62-72.
- Rahman, S. A. & Das, D. K. (2005). The Development of Small and Medium Enterprises in Bangladesh. *Stamford journal of Business Studies*, 1, 108-124.
- Rahman, A. H. M. Habibur. (1981). *Entrepreneurship development in Bangladesh: Problem and Prospect*. The Dhaka University Studies, 2, 10.
- Rahman, A. H. M. Habibur. (1985). *Entrepreneurship and Small Enterprise development in Bangladesh* (Abdul Mannan ed), *Entrepreneurship and Management In Bangladesh*, Chittagong university: Bureau of Business Research.



Rahman, Mohammed Masud. (1993). Entrepreneurship in All Small-Scale Industries: A Case Study. Dhaka University Journal of Business Studies, 14(2).

Roni, N. N. (2003). Environmental Issues of Entrepreneurship Development: Bangladesh Scenario. Dhaka University Journal of Marketing, 6, 159-177.

Salman, A. (2000). Impediment to SME Development: Eliminating the Root Cause. Observer Magazine, 11, 3.

Schumpeter, A. J. (1954). In Theory of Economic Development  
Harvard University Press, Harvard.

Schumpeter, A. J. (1955). Economic Theory and Entrepreneurial development History in Aiken  
(H.G.T. ed), Cambridge: Harvard University Press.

Sharma, S. V. S. et. Al. (1979). Small Entrepreneurial Development in Some Asian Countries: A comparative Study  
Light and Life Publications, New Delhi.

[http://www.cpd-bangladesh.org/media/press\\_050603](http://www.cpd-bangladesh.org/media/press_050603).

## ORGANIZATIONAL CULTURE IMPACTS ON COMPANY'S ABILITY TO ADOPT CONTINUOUS IMPROVEMENT AND WHY ?

<sup>1</sup>Juli Dwina Puspita Sari, <sup>2</sup>Rifyal Dahlawy Chalil, <sup>3</sup>Rita Nengsih, <sup>4</sup>Zenitha Maulida

<sup>1</sup>Juli Dwina Puspita Sari, [juli.dwina@uui.ac.id](mailto:juli.dwina@uui.ac.id), +62811-681-3104

<sup>2</sup>Rifyal Dahlawy Chalil, [rifyal@uui.ac.id](mailto:rifyal@uui.ac.id), +62852-1400-0823

<sup>3</sup>Rita Nengsih, [rita.nengsih@uui.ac.id](mailto:rita.nengsih@uui.ac.id), +62811-682-7775

<sup>4</sup>Zenitha Maulida, [zenitha.maulida@uui.ac.id](mailto:zenitha.maulida@uui.ac.id), +62852-7702-0566

**Department of Economy, Universitas Ubudiyah Indonesia, Aceh, Indonesia**

### Abstract

**Purpose** - The purpose of this paper is to review and critically examine some literatures relating to the impact of organizational culture on company's ability to adopt continuous improvement and why ?

**Design/methodology/approach** - By using scholar's articles, this literature examines the topic from four aspects. At first, the concept of organizational culture and the four different types of organizational culture raised by Quinn and Cameron (1999). Secondly, the concept of continuous improvement (CI) initiative. Lastly, the impact of Organizational Culture on the adoption of Continuous Improvement (CI).

**Practical implications** : The paper provides in depth analysis on the impact of Organizational Culture on the adoption of Continuous Improvement (CI) and why it is necessary for company to thoroughly aware of its organizational culture on the ability of the company to adopt continuous improvement (CI)

**Originality/value**: The paper discusses the relations between organisational culture and its significant impacts on the continuous improvement (CI) initiative as well as reconfirmed that organizational culture adopted by companies does to some extent influence the adoption of CI initiative as well as the successfulness of its implementation

**Keywords** : *organizational culture, continuous improvement, impact, ability, company*

**Paper type** : Literature Review

### Introduction

Over the years, the fact that the market has been saturated by many companies that offer commodity product for customers to enjoy has led to the condition where the needs to come up with better quality of service delivering is becoming more viable for the companies to maintain their long term existence in the market. The initiative to continuously seize company improvement in performance through identifying and implementing continual enhancement (Reid, 2006) in delivering the offering is considered to be the way to enable the company to respond to rapidly changing customers' demand. This idea is presented by many scholars as a continuous improvement (CI) approach that aims to attain both effectiveness and efficiency in operational as well as strategic flexibility through implementing continual interaction between aspects namely operations, learning, incremental enhancement, and radical innovation (Boer, 2002; Boer and Gertsen, 2003; Boer and During, 2001; Corso, 2002; Davison and Hyland, 2006; DeJager et al., 2004; Garvin, 1993; Haikonnen et al., 2004).

However, the importance in having the right organizational culture where those practices are undergoing is argued by previous scholars (Abu-Jarad, Yusof and Nikbin, 2010) as significantly influential since it stimulates innovative behavior within the organization's members. It may also influence the acceptance of employees on innovation as an organization's core value as well as to engage more with organization's business activity (Hartmann, 2006). Moreover, Organizational culture is argued as the most determinant in driving excellent business performance of companies (Gallagher and Brown, 2007 as cited by Abu-Jarad, Yusof and Nikbin, 2010) through enabling companies to effectively replicate the changes as well as implement the flexibility to perform CI which will lead to companies' ability to innovate and offer the best quality of delivery performance to its customers.

Therefore, to have a better understanding on the topic, this literature proposes to critically review and analyze some aspects in accordance to relevant literatures which concern about the topic. This literature review will be examined in the following structure:

1. The concept of organizational culture and the four different types of organizational culture raised by Quinn and Cameron (1999).
2. The concept of continuous improvement (CI) initiative.

3. Impact of Organizational Culture on the adoption of Continuous Improvement (CI). This section will examine the relation between why embedding the right organizational culture has an impact on the likeliness to adopt continuous improvement (CI) by employees.

## **1. The Concept of Organizational Culture**

### **1.1 Theoretical Perspective**

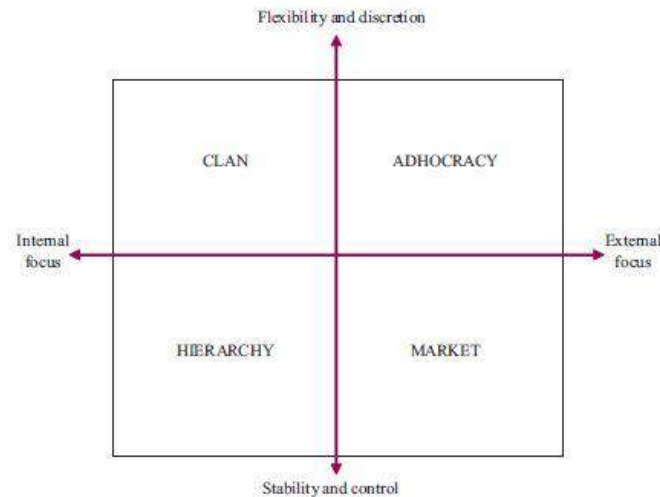
Due to the argument that the concepts of organizational culture and organizational climate do define the same organizational outcome (Denison, 1996) by means the ability of employees' to better comprehend which actions that are perceived by companies as acceptable or vice versa (Griffin and Moorhead, 2006), employees' experience as well as the work setting within the companies (Schneider, Ehrhart and Macey, 2013), the concept of organizational culture is often interchangeably described as an organizational climate by many preceding literatures. Nonetheless, organizational culture is argued as the element which portrays the most profound and fundamental facet in the life of the organization (Denison, 1996). It is referred as "the way things are done around here" (Rostila et al., 2011) or the primary values and assumptions which collectively shared within the organization as well as the belief that depicts an organizational setting which might solve both internal integration and external issues that relates to employees' adaptation (Schneider, Ehrhart and Macey, 2013). Moreover, Berrio (2003) further describes organizational culture as included the definition of value perceived by the company; knowledge sharing for instance, the leadership style, the symbols and language, routines and procedures and what are the characteristics of success defined by the company.

The difference between organizational climate to the previous concept lies in the argument that climate is created by the culture adopted by the organization (Reichers and Schneider, 1990) and it presents as an individual's perception towards organization, instead of collective perception, which is shared between the employees (Lin, 1999; James et al., 2008). Reichers and Schinder (1990) further suggest that the climate is compressed into two different dimensions which are; the individual's psychological climate that refer to the perceptions of his /her has towards its work setting, and organizational climate which relates to the perceptions shared by employees towards the environment of the organization (Ostroff, 1993). Furthermore, while cultures is complied subconsciously by the employees, climate is more observable and consciously resides in the mind of employees for instance; risk taking, openness, and etc (Moran and Volkwein, 1992; Reichers and Schneider, 1990; Sparrow and Gaston, 1996).

However, despite the interchangeable terms used by many scholars in examining the concept, it seems that both climate and culture share a strong conceptual connection in terms of employees' perception and experience within the work setting as well as the values companies are adopted. While climate provides the approach on tangible aspects which manager of the companies can focus on to generate required employees' behaviors, culture proposes the approach on the intangible aspects of a company that will help managers to understand the psychological aspects of the employees within the work setting (Schneider, Ehrhart and Macey, 2013). These two aspects are schemed to create behaviors that help companies to pursue their goals as well as subcultures that characterize the whole companies (Martin, 2002).

### **1.2 Types of Organizational Culture**

According to Quin and Cameron's(1999) the competing value framework which examines the effectiveness of an organization based on the profound structure of the culture, organizational culture can be clustered into four different clusters which are; a) the ad hococracy, b) The clan, c) the market, and d) the hierarchy. This framework clusters culture of the organization based on two dimensions namely; 'flexibility and discretion versus stability and control and external focus versus internal focus and integration' (Valencia, Valle and Jimenez, 2010).



**Source:** Cameron and Quinn (1999)

**Figure1.** Type of Organizational culture by Quin and Rohrbaugh (1983)

In terms of the Ad hoc, this culture is defined as the perspective of open systems as it is externally oriented and highlights both changes and flexibility. The core values being emphasized here are risk taking, creativity, innovation and lastly entrepreneurship oriented. Companies which tend to adopt this culture are characterized as companies that aim to be the leader in the market as well as compete in a dynamic market (Rai, 2011; Valencia, Valle and Jimenez, 2010; Yazici, 2009). Moreover, in regards to the employees' belief and value; The employees are considered as behaving properly once they comprehend the significance of the task given, consideration in details, growth and autonomy (Schneider, Ehrhart and Macey, 2013).

Similar to Ad hoc culture, clan culture also underlines on flexibility, however the focus of this culture is more on the internal of the organization. It is defined as a human relations perspective as it is characterized mainly as a teamwork based company culture where the involvement of employees as well as the companies' commitment towards its employees are emphasized more (Rai, 2011; Valencia, Valle and f, 2010). Moreover, since the basis of its activities is on the human affiliation, it is believed that the employees will act properly once they have a strong sense of connection, trust and loyal to the companies. In regards to the value it infuses, trust, collaboration, attachment and support are the following determinants that define both satisfaction and commitment level exhibit by employees (Schneider, Ehrhart and Macey, 2013). Many scholars argue that in this type of culture, employee that acts in accordance to the collective behavior is perceived as the right thing to do thus being rewarded whereas the offender will experience alienation (Fortado, 1994; Westphal and Khanna, 2003). Hence, due to significance social control within the company, innovation in generating idea along with it supported behaviours are challenging to find (Poskela and Martinsuo, 2009).

In regards to market culture is defined as the perspective of rational goal and control oriented culture, externally focused and perceives competitiveness and productivity as the key values embedded within the organization (sRain, 2011; Valencia, Valle and Jimenez, 2010). Schneider, Ehrhart and Macey (2013) further argue that a clear organizational objective is needed in order for the employees to behave in accordance with the organizational desire and hence be rewarded based on the achievement they make. Moreover, since its behavior is characterized by aggressiveness, task focus and collecting customers and competitor information, increasing in some aspect such as market share, profit, productivity and quality of products are expected by the organization

Lastly, the hierarchal culture is internally focused as well as control orientated (Valencia, Valle and Jimenez, 2010). A workplace which is structured by formal regulations, policies, coordination, efficiency and timeliness orientation are defined as the key values of the organization (Yazici, 2009; Valencia, Valle and Jimenez, 2010). Employees are seen to behave as accordingly when they are provided by clear procedures and role which based formally on organizations' regulations (Schneider, Ehrhart and Macey, 2013).

## **2. Continuous Improvement (CI) Initiative**

Continuous improvement (CI) highlights the notion that companies start to focus on to the capability to continuously improve the process to be competitive in the market instead of merely relying on the process (Teece, 2007). CI is defined as a viable set of processes that emphasis on the means of improvement and its relationships with the important elements and the environment of the companies which enable companies to enhance their performance (Nisson-Witell et al., 2005; Bessant

et al., 2001) through increasing business performance such as decrease setup time, errors, lead time, breakdown, waste, as well as the performance of people, by means people empowerment, development, the quality of life work and the participation (Hyland et al., 2004). The form of CI initiatives is generally identified as a lean production, TQM, six sigma and so on (Voss, 2005; Oliver, 2009). CI is argued as prominent as it relates to companies' capability to defeat their competitors by actively involving employees, continual innovation (Caffyn, 1999) hence overcomes the dynamic change of environment along with its uncertainties (Bessant and Francis, 1999).

The idea of CI requires internal and external overall collaboration of companies' member as well as welcome to change seems to align with previous researchers which posit that the values of CI is commonly associated cooperation (Oakland, 1997), responsibility and integrity (Goetsch and Davis, 2000), openness (Steyn, 1999; Roberts, 1992), humbleness (Gupta, 1996; Gibson, 1995), respect for others (Seiling, 1999), and empathy and responsiveness (Bogue, 1997). Therefore to disseminate those values, firstly the leadership of managers is suggested to stop perceiving themselves as individuals that have the power to control and monitor, and to start acting as leaders who empower employees to do better and challenge the status quo (Parker, 2012). Managers are also suggested to show as being committed to those values by enacting, voicing, coaching on them so that it will allow the personality to exhibit as an organizational culture that offer structural support and change the system control focus to realize changes on organizational behavior (Singh and Singh 2012).

Moreover, CI is also performed by constructing customer requirements internally and externally, fulfilling the requirements, assessing or quantifying the success, and constantly checking the requirements in order to identify the aspects which required future improvements (Chang, 2005). Bessant and Caffyn (1997) argue that in regards to companies' capability to undergo CI, the ability of companies to employ certain approaches for undertaking CI, key behaviors reinforce CI displayed by employees, and mediators; the methods, techniques and procedures utilized to enhance CI initiatives are some of behavioral pattern that is suggested to be present within the a company. In terms of its objective, all types of CI initiative should be premised on the customer satisfaction notion (Singh and Singh, 2012) since for instance; if product improvement undergone by a company does not meet the needs and expectations of its customers and therefore fails to result in satisfaction will be seen as a waste and will not generate any profit for the company in the end (Dean and Bowen, 1994). Therefore, in order to optimize its benefit towards the companies, substantial cultures namely continuous learning from mistakes, individual learning deployment, and so on are considered to be essential to be established (Nilsson-Witell et al., 2005) as they may encourage feedback made by the employees for performance evaluation as well as companies' knowledge incorporation (Oliver, 2009).

### **3. Impact of Organizational Culture on the adoption of Continuous Improvement (CI)**

As argued earlier, the premise that underline CI seems to be revolving around the ability for companies to implement continuous learning and innovation as well as the ability of company' members to willingly accept the change. Number of researches have endeavored to examine the key determinants on those topics. Some studies taken by Gibb and Davies (1990); Bessant et al., (1994); Alavi and Leinder, (2001) highlight on the culture of the organization in supporting the means as one of the key endorse factors as well as the management of human resources and culture of the organization as the people in the organization are the key factor in creating and sharing knowledge (Lang, 2001),

In regards to companies' culture and the values of CI such as learning focus, hierarchy culture adopted by companies seem to inhibit the overall effectiveness of CI due to its high level of formal control as well as procedures. Consequently, it deters the process of learning undertaken, empowerment, change driven focus, communication and risk taking behavior within the companies (Valencia, Valle and Jimenez, 2010). Similarly, market culture can also impact negatively to companies' learning focus as it based its performance on target accomplishment, it may distract the long term driven goal which associated more to learning focus values. Conversely, both Ad hoc and clan cultures seem to generate the most positive impact on the learning focus as they foster the flexibility as well as encourage teamwork, openness, commitment, risk raking behavior, change driven and so on (Lee and Chen, 2005; Valencia, Valle and Jimenez, 2010).

In regards to the innovation value, number of researches seem to agree that in order for companies to implement incremental innovation as their value, a culture which foster flexibility is essential as it generates autonomy and freedom which are required to realize innovation (Arad et al., 1997; Martins and Terblanche, 2003). It aligns with characteristics of ad hoc culture as it endorses flexibility and external focus of the companies and promotes important values such as risk taking and creativity (Valencia, Valle and Jimenez, 2010). This type of culture (external focus) does support innovation since it has various methods to enhance the probability of gaining information that leads to benefitting the idea generation and innovation within the companies (Kimberly and Evanisko, as cited in Valencia, Valle and Jimenez, 2010). Moreover, since they focus their innovations externally (competitors, customers, industry, environment), it is likely that all information obtained are more relevant and useful in carrying out innovation as the groundwork (Valencia, Valle and Jimenez, 2010).

On the other hand, considering the characteristics of clan culture, it is argued that it may encourage innovations as it underpins employees involvement and teamwork, but since it also focuses on internal of companies, it may reduce the access to a new idea that is generated from outside of companies (Lucas and Ferrel, 2002) thus inhibit the companies to keep up with any changes on customers' needs and want. It also goes to both hierarchal culture and market culture as they promote the value of stability, control and internally focused (Obenchain, 2002; Lau and Ngo, 2004; Obenchain and Johnson, 2004; Valencia, Valle and Jimenez, 2010) since such companies tend to favor centralization and high degree of formalization which later on hinder innovation to take place (Valencia, Valle and Jimenez, 2010).

Furthermore, regarding the willingness of companies' members to accept changes, it is found that there is a positive correlation between the employees' perception that the companies have a change culture (defined by ad hoc or market culture) towards the willingness to participate and welcome the changes (Lam and Robertson 2012). This finding seems to align with the theory of reasoned action raised by Fishbein and Ajzen (1975, as cited by Lam and Robertson, 2012) which found that individual's intention towards certain behavioral (in this case openness towards changes) can be predicted by her/ his attitudes towards the value. Other scholars further explain that since both value and beliefs that employees shared towards the changes are defined as elements which comprised culture, they are expected to underpin the changes to happen as well (Detert, Schroeder and Mauriel, 2000; O'Reilly and Chartman, 1996; Lam and Robertson, 2012).

Hence, even though it is unquestionable that the implementation of CI within a company indeed helps in achieving the goals which leads to competitive advantage, yet the perception, attitudes and behavior of employees towards the initiative as well as cultural aspects of companies are also significantly influence the successfulness of CI eventually (Singh and Singh, 2012). Moreover, the fact that each company poses a distinct level of capability and potential value perceived on the adoption of CI, extreme transformation of cultural changes that shift the relationships between the members of a company, communication patterns between employees, procedures, roles, structures and rules within the company may also inhibit the effectiveness of CI (Laugen and Boer, 2008). It may happen since in general drastic changes to implement CI may be perceived by employees as threatening as they need to learn and adjust to new working methods and required the employees to leave their comfort zone (Parker, 2012). Therefore, in order to effectively implement CI, companies need to design shared values and beliefs on the initiative and disseminate it throughout the system, and then modify cultures that underpin the values of continuous learning and innovation (Skerlavaj, Song and Lee, 2010).

#### **4. Conclusion and Further Research**

From the literature, it is reconfirmed that organizational culture adopted by companies does to some extent influence the adoption of CI initiative as well as the successfulness of its implementation. This is merely because the flexibility, belief and values that organizational culture adopted indeed provide the capability of employees to effectively carry out CI as its competitive advantage to quickly respond and adjust to any changes within the market. Therefore, creating the right cultural environment which voices the support towards the initiative is important in order to stimulate innovative and acceptance behavior within the organization's members towards the CI.

For further research, this literature suggests that more researches should be taken in regards to the topic since it appears that there is still a lack of studies that identify the pattern to which culture of companies might impact on the success of CI's implementation. By doing so, it will provide better comprehension on the topic towards companies intention to adopt CI as their competitive strategy.

#### **References**

- Abu-Jarad, I.Y., Yusof, N. and Nikbin, D. (2010), A review paper on organizational culture and organizational performance, *International Journal of Business and Social Science*, 1(3), 26-46.
- Arad, S., Hanson, M. and Schneider, R. (1997), A framework for the study of relationships between organizational characteristics and organizational innovation, *The Journal of Creative Behavior*, 31 (1), 42-58.
- Alavi, M. and Leinder, D. (2001), Review: knowledge management and knowledge management systems; conceptual foundations and research issues, *MIS Quarterly*, 25 (1), 107-36.
- Berrio, A.A. (2003), An organizational culture assessment using the competing values framework: a profile of Ohio State University Extension, *Journal of Extension*, 41(2).
- Bessant, J., Caffyn, S., Gilbert, J., Harding, R. and Webb, S. (1994), Rediscovering continuous improvement, *Technovation*, 14 (1), 17-29.
- Bessant, J. and Caffyn, S. (1997), High-involvement innovation through continuous improvement, *International Journal of Technology Management*, 14 (1), 7-28.
- Bessant, J. and Francis, D. (1999), Developing strategic continuous improvement capability, *International Journal of Operations & Production Management*, 19 (11), 06-19.

- Bessant, J., Caffyn, S. and Gallagher, M. (2001), An evolutionary model of continuous improvement behavior, *Technovation*, 21, 67-77.
- Boer, H. and During, W.E. (2001), Innovation, what innovation?: a comparison between product, process and organizational innovation, *International Journal of Technology Management*, 22, 83-107.
- Boer, H. (2002), Continuous innovation seminar, presented at University of Western Sydney, Campbelltown.
- Boer, H. and Gertsen, F. (2003), From continuous improvement to continuous innovation: a retro perspective, *International Journal of Technology Management*, 26 (8), 805-27.
- Bogue, G.E. (1997), Beyond systems: moral outrage and other servants of quality, *Technovation*, 14(3), 7-28.
- Caffyn, S. (1999), Development of a continuous improvement self-assessment tools, *International Journal of Operations & Production Management*, 19 (11), 38-53.
- Chang, H.H. (2005), The influence of continuous improvement and performance factors in total quality organization, *Total Quality Management & Business Excellence*, 16 (3), 413-37.
- Cameron, K.S. and Quinn, R.E. (1999), *Diagonising and changing organizational culture*, Addison-Wesley, Reading, MA.
- Caruso, M. (2002), From product development to continuous product innovation: mapping the routes of corporate knowledge, *International Journal of Technology Management*, 23 (1), 322-40.
- Davison, G. and Hyland, P. (2006), Continuous innovation in a complex and dynamic environment: the case of the Australian health service, *International Journal of Technology Management & Sustainable Development*, 5 (1), 41-59.
- Dean, J.W. and Bowen, D.E. (1994), Management theory and total quality: improving research and practice through theory development, *Academy of Management Review*, 9 (3), 392-418.
- DeJager, B., Minnie, C., deJager, J., Welgemoed, M., Bessant, J. and Francis, D. (2004), Enabling continuous improvement: a case study of implementation, *Journal of Manufacturing Technology and Management*, 15 (4), 315-24.
- Denison, D.R. (1996), What is the difference between organizational culture and organizational climate? A native's point of view on a decade of paradigm wars, *The Academy of Management Review*, 21 (3), 619-654.
- Detert, J.R., Schroeder, R.G., and Mauriel, J.J. (2000), A Framework for Linking Culture and Improvement Initiatives in Organizations, *The Academy of Management Review*, 25 (4), 850-863.
- Fortado, B. (1994). Informal supervisory social control strategies, *Journal of Management Studies*, 31 (2), 251-74.
- Garvin, D. (1993), "Building a learning organization", *Harvard Business Review*, Vol. 74 No. 4, pp. 78-91.
- Gibb, A. and Davies, L. (1990), In pursuit of frameworks for the development of growth models of the small business, *International Small Business Journal*, 9 (1), 15-31.
- Gibson, P. (1995), One renewal journey, *The Journal for Quality & Participation*, 18 (4), 62-80.
- Goetsch, D.L. and Davis, S.B. (2000), *Introduction to Total Quality Management: Quality Management for Production, Processing and Services*, 3rd ed., Prentice-Hall International, Englewood Cliffs, NJ.
- Griffin, R.W. and Moorhead, G. (2006), *Fundamentals of organizational behavior: Managing people and organizations*, Houghton Mifflin Company, Boston.
- Gupta, R. (1996), Everything in the garden's lovely, *The Economist*, 340 (76), 56.
- Haikonen, A., Savolainen, T. and Jaervinen, P. (2004), Exploring Six Sigma and CI capability development: preliminary case study findings on management role, *Journal of Manufacturing Technology and Management*, 15 (4), 369-78.
- Hartmann, A. (2006), The role of organizational culture in motivating innovative behavior in construction firms, *Construction Innovation*, 6 (3), 159-72.
- Hyland, P.W., Milia, L.D. and Terry, R.S. (2004), CI tools and technique: are there any difference between firms?, *Proceedings 5th CINet Conference*, Sydney, Australia.
- James, L.R., Choi, C.C., Ko, C.E., McNeil, P.K., Minton, M.K., Wright, M.A. and Kim, K. (2008) Organizational and psychological climate: a review of theory and research, *Europe Journal of Work and Organizational Psychology*, 17 (5), 5- 32.
- Lam, C. and Robertson, D. (2012), Organizational Culture, Tenure, and Willingness to Participate in Continuous Improvement Projects in Healthcare, *The Quality Management Journal*, 19 (3), 7-15.
- Lang, J.C. (2001), "Managerial concerns in knowledge management", *Journal of Knowledge Management*, Vol. 5 No. 1, pp. 43-57.
- Laugen, B.T. and Boer, H. (2008), "Continuous innovative practices and operational performance", *International Journal of Technology Management*, Vol. 44 No 3/4, pp. 338-53.

- Lau, C.M. and Ngo, H.Y. (2004), "The HR system, organizational culture, and product innovation", *International Business Review*, Vol. 13 No. 6, pp. 685-703.
- Lee, C.H. and Chen, W.J. (2005), "The effects of internal marketing and organizational culture on knowledge management in the information technology industry", *International Journal of Management*, Vol. 22 No. 4, pp. 661-72.
- Lin, C. (1999), "The Association between organizational climate and quality management practices: An empirical study on small and medium-sized manufacturing companies in Taiwan", *Total Quality Management*, Vol.10 No. 6, pp. 863-869.
- Lucas, B.A. and Ferrell, O.C. (2000), "The effects of market orientation on product innovation", *Journal of the Academy of Marketing Science*, Vol. 28 No. 2, pp. 239-47.
- Martin J. (2002), *Organizational Culture: Mapping the Terrain*, Thousand Oaks, CA: Sage.
- Martins, E. and Terblanche, F. (2003), "Building organizational culture that stimulates creativity and Innovation", *European Journal of Innovation Management*, Vol. 6 No. 1, pp. 64-74.
- Moran, E.T. and Volwein, J.F (1992), "The Cultural Approach to the Formation of Organizational Climate", *Human Relations*, Vol. 45 No. 1, pps. 19-47.
- Nilsson-Witell, L., Antoni, M. and Dahlgard, J.J. (2005), "Continuous improvement in product development: Improvement programs and quality principles, The International Journal of Quality & Reliability Management, 22 (8/9), 753-768.
- Oakland, J.S. (1997), Interdependence and cooperation: the essentials of total quality management, *Total Quality Management*, 8 (2), 10-24.
- Obenchain, M. (2002), Organizational culture and organizational innovation in not-for-profit, private and public institutions higher education, Doctoral dissertation, Nova Southeastern University, Davie, FL.
- Obenchain, A. and Johnson, W. (2004), Product and process innovation in service organizations: the influence of organizational culture in higher education institutions, *Journal of Applied Management and Entrepreneurship*, 9 (3), 91-113.
- Oliver, J. (2009), Continuous improvement: role of organizational learning mechanisms, *International journal of quality & reliability management*, 26 (6), 546-563.
- O'Reilly, C., Chatman, J., and Caldwell D. (1991), People and organizational culture: a profile comparison approach to assessing person-organization fit, *The Academy of Management Journal*, 34 (3),. 487-516.
- Ostroff, C. (1993), The Effects of Climate and Personal Influences on Individual Behavior and Attitudes in Organizations, *Organizational Behavior and Human Decision Processes*, 56 (1), 56-90.
- Parker, D.W (2012), *Service operation management: The total experience*, Edward Elgar, UK.
- Poskela, J., and Martinsuo, M. (2009), Management control and strategic renewal in the front end of innovation, *Journal of Product Innovation Management*, 26, 671-84.
- Rai, R.K. (2011), Knowledge management and organizational culture: a theoretical integrative framework, *Journal of knowledge management*, 15 (5), 779-801.
- Reid, R.A. (2006), Productivity and quality improvement: an implementation framework, *International Journal of Productivity and Quality Management*, 1 (1/2), 26-36.
- Roberts, R.A. (1992), You want to improve? First you must change, *Supervision*, 53 (8), 17-19.
- Schneider, B., Ehrhart, M.G. and Macey, W.H. (2013), Organizational climate and culture, *Annual review of psychology*, 64 (1), 361-388.
- Seiling, J.G. (1999), Reaping the reward and rewarding work, *The Journal of Quality and Participation*, 22 (2), 16-20.
- Singh, J. and Singh, H. (2012), Continuous improvement approach: state-of-art review and future implications, *International Journal of Lean Six Sigma*, 3 (2), 88-111.
- Škerlavaj, M., Song, J.H. and Lee, Y. (2010), Organizational learning culture, innovative culture and innovations in South Korean firms, *Expert Systems with Applications*, 37 (9),. 6390-6403.
- Sparrow, P.R. and Gaston, K. (1996), Generic climate maps: a strategic application of climate survey data?, *Journal of Organizational Behavior*, 17 (6), 679-98.
- Steyn, G.M. (1999), Out of the crisis: transforming schools through TQM, *African Journal of Education*, 19 (4), 357-63.
- Teece, D.J. (2007), Explicating dynamic capabilities: the nature and micro foundations of sustainable enterprise performance, *Strategic Management Journal*, 28 (11), 1319-1350.
- Valencia, J.C.N., Valle, R.S. and Jime'nez, J.D. (2010), Organizational culture as determinant of product innovation, *European Journal of Innovation Management*, 13 (4), 466-480.



- Voss, C.A. (2005), Paradigms of manufacturing strategy revisited, *International Journal of Operations & Production Management*, 25 (12), 1223–1227.
- Westphal, J.D., and Khanna, P. (2003), Keeping directors in line: Social distancing as a control mechanism in the corporate elite, *Administrative Science Quarterly*, 43, 361–98.
- Yazici, H.J. (2009), The Role of Project Management Maturity and Organizational Culture in Perceived Performance, *Project Management Journal*, 40, (3), 14-3.

# **The Role of Entrepreneurship in the Production Function and its Effect on Revenue of Batik Industry in Central Java**

**Edy Dwi Kurniati**

Faculty of Economics and Business  
University of Darul Ulum Islamic Centre Sudirman GUPPI (UNDARIS)  
Semarang Region, Central Java, Indonesia  
+628122918845 [kurni\\_edy@yahoo.co.id](mailto:kurni_edy@yahoo.co.id)

## **Abstract**

In order to face the Asean Economic Community in 2015, the Small and Medium Enterprises (SMEs) in batik industry is impossible rely solely on the ability of production which oriented on tradition as a local uniqueness source, subsidies and government assistance, but should have efficiency in the economic scale, having a competent quality resources in its field, independent and has a strong brand in the market. To face the ASEAN free market, entrepreneur's factors in the batik industry have an important role to improve efficiency and business revenue in achieving a competitive advantage. This study analyzed the role of entrepreneurship in the production function and its effect on the batik industry revenue. The study was conducted by distributing questionnaires to 100 SMEs in the Batik Centre of Solo, Pekalongan and Lasem (Rembang). Sampling was conducted by a purposive sampling, while the analyze data using the Deterministic Frontier statistics and regression the results found that the variable costs of labor, materials and overhead costs have a significant influence on the value of production and sale of batik SMEs, but price efficiency and economical efficiency is still low, it indicates that the advantage profit is not proportional to the cost incurred. In other side, the results of this study also found a positive relationship between entrepreneurs roles in supporting the efficiency. The role of entrepreneurship in product innovation, business alliances and marketing innovation has a positive impact on sales value of batik. The role of entrepreneurs in marketing innovation has the highest elasticity of the production and sale of batik, and then followed by the role of entrepreneurs in new product innovation, especially in the price efficiency and economical efficiency.

**Keywords** *entrepreneurship, production function, reveueues*

## **1. Background**

The development of the batik industry as one of the 14 components of the creative industries needs to be improved, given the batik market trends and prospects in the global market promising. Batik industry has contributed to moving the national economy with an export value of 761 million USD in 2011. Beside that, amounted to 99.39 of 326 business units engaged in the batik industry is the Micro, Small and Medium Enterprises (SMEs), with absorption batik industry worker about 838 million people are spread in various regions in Indonesia. Its means there is a large contribution from the batik industry to job opportunities and increase incomes. The additional value of the batik industry is increasing every year with the average growth of 32.27% (Department of Industry, 2013).

Batik SMEs have potency to be developed as a major industry in the longterm. Among those are: (1) batik as a component of textile products industry, has a short life cycle in terms of design or lifestyle motifs so as to ensure the sustainability of demand. (2) the demand on batik market influenced by market tastes (trend). (3) there is an element of locality in competing for the support of the international fashion products, and (4) can be produced by handmade and with

technology (NetFinTex, 2013). The potential of the Indonesian market for commodities is relatively large for the needs of the textile fabric of urban communities not only in the form of clothing, but also the needs of non-clothing such as accessories, hats, and so on (Hermawan, 2011).

In a competitive industrial environment, entrepreneur factor of batik industry have an important role to increase efficiency and revenue. Its capacity in batik SMEs is needed to compete in local, domestic or global market, for the example on managing the production resources, flexibility and the ability to identify business opportunity also market potency based on product and its unique service. Although the batik SMEs has several potencies to develop, but its also has several problems, among them are: limited access especially related to capital, has no economics scale efficiency, high cost on access and using information technology, low skill and knowledge (related to using of technology, entrepreneurship, managerial, accounting and marketing) to serve the consumers both in domestic or export market, has no information about market opportunity, high in transaction cost (especially on infrastructure access), limited related to reach out the quality standard (Harvie, 2004:14).

In the long term, the batik SMEs can not only rely production capabilities rooted in tradition as a source of uniqueness in the market to compete in local, domestic and global markets, but also has other advantages, such as the dynamic design and competitive, understanding quality control, understanding environmental issues such as eco-design and eco-labeling, understanding export procedures, have economies scale efficiency in other hand mastery on technical and other management controls such as entrepreneurial, managerial, accounting and marketing (Harvie, 2004: 14). Based on this background, this research wants to analyze the role of entrepreneurship in the production function and the effect on revenues of batik industry.

## **2. Literature**

### **2.1. Production Process Concept**

The production process is an activity to change the *input*, which is also called the factors of production into output so that the goods have a value. The production process generally requires various types and factors of production which is called as resource to produce a number of output productions. (Soekarwati, 2003: 47). Each production process has a technical foundation called the production function. Production function is the relationship between the quantity of inputs used to make products (Mankiw: 2000: 313).

Production function with one factor of production is the relationship between the level of production with the use of factors of production, while the factors of production other use is considered fixed at a certain level (*ceteris paribus*). The relationship between the output produced and the factors of production are used it is often expressed in the production function (Mankiw, 2000: 326). According to Ngurah Agung et al. (2008: 132-146) there are some production functions frequently used in the analysis is the Cobb-Douglas production function, linear, quadratic, exponential, CES (constant elasticity of substitution), the transcendental, and translog.

## 2.2. Production Function of Cobb-Douglas

Cobb-Douglas Production function is the most popular production function which used on economics analysis and its role is very important to decide the resources efficiency as *efficiency parameter*. Mathematically, formula of production function mentioned as:  $Y = f(X_1, X_2, X_3, \dots, X_n)$ . This function read as: Y product is function of produksion factor X1, if production factors of X2, X3, ....., Xn the used is appointed on a certain level. The only production factor which can be changed its using number is produksi factor of X1. Fungsi produksi Cobb Douglass can be formulated as follows:

$$Q = Q(K, L) = AK^\alpha L^{1-\alpha} \dots \dots \dots (2.1)$$

$$Q = Q(L, K_1, K_2, K_3, z) \dots \dots \dots (2.2)$$

Where : Q = produksi number (unit), K= Capital (unit), L=Labour measured from the labour numbers (unit), A= Efisiensi parameter, K1= The use of materials (unit), K2= the use of additional materials (unit), K3= the use of tools/Teknologi (*dummy*), z= Inovasion (unit).

Furthermore will be discussed enterpereneurship factors (*entrepreneurship*) as manager source factor which is as faktor produksi. Production function is relations between input quantity that used to produce a good (Mankiw, 2008: 313). Production function in the production activity formulated as (Pasay *et al.*, 2008: 146):

$$Q = AK^\alpha L^{1-\alpha} \text{ Where:}$$

$$A = \phi h^\gamma$$

$$h = f(E)h \dots \dots \dots (1)$$

Then, the innovation activity will be shown as (Ngurah Agung *et al.*, 2008: 146):

$$Q_R = \phi K_R^\beta + A_R z \text{ Where:}$$

$$z = L_R h,$$

$$K_R = g(E)K_R \dots \dots \dots (2)$$

Quantity production of goods / services as activities for the fulfillment of human needs is limited because of the economic resources available is always limited in number. Entrepreneur has the function of managing limited resources to produce a higher output in the fulfillment of these needs through innovation effort. In the aspect of demand, entrepreneurs have a role to increase the demand for goods and services. In the production aspect of entrepreneurship has a role to manage the resources (inputs) are as low as possible to produce the highest output through the creation of added value and production efficiency. High demand for goods and services will increase production volume and revenue, but the increase in revenue is influenced by factors other than production volume is also influenced by the price and cost of production, as well as entrepreneurial skills in managing resources to produce higher value-added and business efficiency through innovation activity (Audretsch and Keilbach, 2007).

Revenues of innovation activities can be formulated as (Audretsch dan Keilbach, 2007).

$$\pi_R = \theta K_R^\beta + A_R z^\beta - w_R z - \rho_R K_R \dots \dots \dots (4)$$

Where  $W_R$  is earning of labour capital per unit, and  $\rho_R$  is income average of innovation resources. To maximize the income of innovaton activities as output function and demand  $\frac{d\pi_R}{dK_R} = 0$  can be formulated as:

$$\rho_R = \beta\theta K_R^{\beta-1} \dots\dots\dots(5)$$

In the next, income of activity will maximize the profit of innovation activity can be defined as (Audretsch dan Keilbach, 2007).

$$\pi_p = AK_p^{1-\alpha} L_p^\alpha - w_p L_p - \rho_p K_p \dots\dots\dots(6)$$

Based on the definition  $\frac{K_p}{L_p} = k$  equation 7 can be wrote:

$$\rho_p = (1 - \alpha)A k^{-\alpha} \dots\dots\dots(7)$$

When the market is static, entrepreneurial through innovation process introducing new products, production methods, markets, sources of supply, or a combination of the industry which is affect the economy out of previous equilibrium (Schumpeter, 1934). Furthermore, entrepreneurs find opportunities to meet the demand to reach a new equilibrium (Kirzner, 1973). So Schumpeter's theory explains that entrepreneur is acting as innovators to produce new combinations with innovation and create opportunities. Resource-based view (Resource Based View / RBV), explains that entrepreneurship creates a 'core competence' (eg, Hamel and Praharad, 1994), the ability to change dynamically (Dynamic Capability) (eg, Teece, Pisano & Shuen, 1997), creating valuable products, unique, not easily imitated (Barney, 2002), 'capability lifecycle' (Helfat & Peteraf, 2003), and put the new skills in the appeal routine expertise (eg, Nelson & Winter, 1982).

If enterpreneur want to developpe a new capital to innovation activity through *research and development* also through the use of technology, can be werote as (Audretsch dan Keilbach, 2007).

$$\int_t^{+\infty} \rho_R e^{-\gamma(x-t)} dx > \int_t^{+\infty} \rho_p e^{-\gamma(x-t)} dx \dots\dots\dots(8)$$

Where  $r$  is average of interest level. Substitution of left equation (4) with equation (5) and substitution of right side equation (6) with equations (7) dan (8), can be observed as (Audretsch dan Keilbach, 2007):

$$\frac{\beta\theta K_R^{\beta-1}}{r - (\beta-1)g(E)} > \frac{(1-\alpha)\theta k^{-\alpha} h^\gamma}{r - \gamma f(E)} \dots\dots\dots(9)$$

While function of efficiency improvement, the role of entrepreneurship can be formulated as (Audretsch dan Keilbach, 2007):

$$TE = \frac{d\pi r}{d\pi k} \dots\dots\dots(10)$$

Where, TE= technical efficiency,  $d\pi r$  = efficiency profit,  $d\pi k$  = resources which spend to improving the efficiency such as: the use of tehcnology and activities of product innovation.

### 3. Research Method

This research was conducted at the batik industry in Central Java, Indonesia. Consideration of place selection due to the potential for innovation and product development of the batik industry in Central Java as the data of Industry and Trade Provincial Agency in Central Java Indonesia (2006) has developed in recent years, especially in some areas of the centre of batik, so it is relevant to be studied. Based on data from this agency, the amount of the batik industry in the year of 2013 said that in Central Java as many 538 businesses, consisting of the 55 major industries, 221 medium scale industries and 262 small-scale industries.

The study was conducted with a sample of 100 respondents, entrepreneurial SMEs in Central Java Batik Sentra include: Surakarta City, Pekalongan District, and Rembang District (Lasem). The results of the questionnaire then tabulated and analyzed to determine the accuracy of existing research models. Sampling technique conducted with a purposive sampling, and proportional random sampling. The variables consisted of exogenous variables include: the cost of labor, raw and auxiliary materials and fixed costs as well as endogenous variables include production efficiency and revenue batik. Data processing is done by analyzing the role of entrepreneurship to the efficiency of production and revenue batik using deterministic statistical frontier with statistical technique to estimate frontier designed by Afriat (1972) and developed by Richmond (1974) and Greene (1980) and regression to determine the effect of role entrepreneurship in innovation.

### 4. Research Result

#### 4.1. Efficiency Analysis with Production Function of *Frontier Stokastik*

Tabel 1 show that generally from independent variable which consist of labour cost ( $X_1$ ), material cost ( $X_2$ ) and fixed cost ( $X_3$ ), discovered that its elastic production more than 1 (1,081). It means in *increasing return to scale* condition, seen from coefficient value, for those variables has positive values.

**Tabel 1: Estimation Result of Production Function of *Frontier Stokastik***

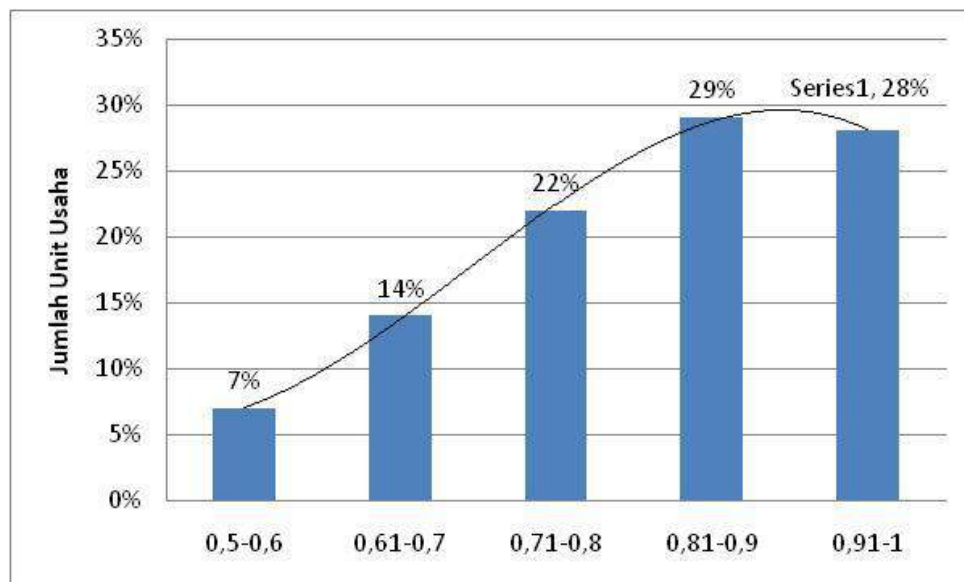
		Model ke-1
	<b>(Constant)</b>	0,141
	<b>LnX<sub>1</sub></b>	0,723
	<b>LnX<sub>2</sub></b>	0,223
	<b>LnX<sub>3</sub></b>	0,135
	<b>Return to scale</b>	1,081
	<b>Technical</b>	0,885
<b>Efficiency Mean</b>	<b>Technical Inefficiency</b>	0,115
	<b>Mean</b>	
	<b>N</b>	100

Sources : processed from questionnaire datas (2014)

#### 4.1.1. Technical Efficiency

Based on the data obtained if the average technical efficiency of 0.985, this means that the average technical efficiency achieved is 98.5% of batik entrepreneurs of the frontier that maximum productivity is achieved by processing system batik SMEs in three areas of research have been good, because it technically efficient approach considering technical efficiency is the relationship between the inputs actually used with the output from the maximum value is 1.

In figure of 4.1 presented the distribution of batik SMEs in accord with technical efficiency level which reached by entrepreneurs individually.



Source : processed from questionnaire datas (2014)

**Figure 1 Technique Efficiency Spread of Batik SMEs**

#### 4.1.2. Price Efficiency (Allocative)

Price efficiency (allocative) is a situation when the marginal product value (MPV-Marginal Product Value) is equal to the production factor price which is concerned, or the way in which entrepreneurs are able to maximize profits. In the discussion of price efficiency (allocative) this will result in three outcomes possibilities: (1) if the value of the efficiency is greater than 1, this means that the maximum efficiency has not been achieved, so the use of factors of production should be increased in order to achieve an efficient condition. (2) if the value of efficient smaller than 1, it is that the business activities carried batik inefficient, so as to achieve the efficient level of production factors used should be reduced. (3) if the efficiency values equal to 1, this means that the business of batik has reached levels that are run efficiently and obtain maximum profit. Marginal Product Value (MPV) here is obtained from the coefficient of each variable multiplied by the average of the total revenue

divided by the average cost of each of these variables.

Therefore, the calculation of the analytical calculation of price efficiency (allocative) is issued costs for activities batik SMEs in units of dollars. Including the earned income, so you will know the amount of price efficiency in batik SMEs.

**Tabel 2 Number of Total Cost, Average and Batik SMEs Revenue**

Items	Total (Rp)	Average	Ko efisien
Production (Y)	2,773,690,0	27,736,900	-
Labour Cost (X1)	915,400,000	9,154,000	0,723
Material Cost (X2)	553,478,000	5,534,780	0,223
Fix Cost (X3)	180,620,000	1,806,200	0,135

Source: processed data (2014)

The calculation of the price efficiency will be as follows :

NPM Labour Cost (NPM<sub>1</sub>) X1

$$\begin{aligned} \text{NPM} &= \frac{(0,723)(27,736,900)}{9,154,000} \\ &= 2,191 \end{aligned}$$

The result of the calculation of the price efficiency for the use of production factors of Labor Cost is 2.191. The results of these calculations indicate that the use of production factors in the price of capital is not efficient, because the results of the calculations show numbers greater than 1, so we need additional capital inputs in order to achieve efficient.

NPM raw material cost (NPM<sub>2</sub>) X2

$$\begin{aligned} \text{NPM} &= \frac{(0,135)(27,736,900)}{5,534,780} \\ &= 1,118 \end{aligned}$$

The results of the calculation of the efficiency of the use of production factors prices for raw materials, namely 1,118. These results indicate that the use of input raw material was still not very cost efficient, because the calculation results showed the efficiency of the price is greater than 1, so it is necessary to increase the input of raw materials in order to achieve the level of efficiency.

NPM Fix Cost (NPM<sub>3</sub>) X3

$$\begin{aligned} \text{NPM} &= \frac{(0,723)(27,736,900)}{1,806,200} \\ &= 2,073 \end{aligned}$$

The results of the calculation of the efficiency of the price for the use of fixed cost factor are 2.073. These results indicate that the use of fixed costs of production factors has not yet efficient in price, because the price of efficiency calculation results show numbers greater than 1, so it is necessary to input additional fixed costs in order to achieve the level of efficiency.



After calculating the NPM every production factors, value of cost efficiency as follow:

$$EH = \frac{NPM_1 + NPM_2 + NPM_3}{3}$$

$$EH = 1,794$$

So that number of efficiency cost (allocative) on batik SMEs is 1,794. This calculation show that batik SMEs not efficient in the price yet, because the cost of efficiency values more than 1, so it is necessary to increase production inputs in order to become more efficient.

#### **4.1.3. Economic Efficiency**

Economic efficiency (EE) obtained from the product of the technical efficiency and price efficiency (allocative). The result of the technical efficiency calculation in mind magnitude is 0.985, and price efficiency (allocative) of 1.794. Economic efficiency can be achieved if the technical efficiency and price efficiency has been achieved, then the magnitude of economic efficiency can be calculated as follows. So the magnitude of the economic efficiency of batik SMEs amounted to 1,767. This means that SMEs batik economically inefficient so we need additional input in order to achieve efficiency.

$$\begin{aligned} EE &= ET \times EH \\ &= 0,885 \times 1,794 \\ &= 1,588 \end{aligned}$$

#### **4.1.4. Return to Scale**

Return to scale is a situation where output increased as a response to the proportional increase of all inputs. As it is known that the Cobb-Douglas function, the coefficient of each independent variable on the dependent variable is the elasticity. Based on Table 4.6, it can be seen return to scale of SMEs batik through the summation of each independent variable.

$$\begin{aligned} \text{Return to scale} &= \beta_1 + \beta_2 + \beta_3 \\ &= 0,723 + 0,223 + 0,135 \end{aligned}$$

Value of return to scale on batik SMEs is 1,081. Returns to scale is obtained from the addition of elasticity coefficients for each independent variable in the study. This suggests that the batik SMEs are at Increasing Returns to Scale (IRS). This means that the proportion of additional factors of production will result in additional production has a greater proportion.

## **4.2. The Role of Entrepreneur on Efficiency**

Based on the results of data processing can be found the results of the analysis of

innovation efficiency batik sales as follows:

- a. Batik entrepreneurs in SMEs more active in product innovation, marketing innovation and business alliances in general have lower technical efficiency, but have a price efficiency and higher economic efficiency. In terms of technical efficiency, comparison of production costs on the production output of batik SMEs with a focus on product innovation is lower (technical efficiency = 0.883) compared with inactive SMEs batik product innovation (technical efficiency = 0.895).
- b. Batik SMEs more involved in business alliances and marketing innovation, has a ratio of production costs on the production output at a lower batik SMEs (technical efficiency = 0.893 and 0.894) compared with the batik SMEs are not involved in business alliances and marketing innovation (technical efficiency = 0.896 and 0.895).
- c. Batik entrepreneurs in SMEs more active in product innovation, marketing innovation and business alliances in general have a higher price efficiency (efficiency price = 2.062; 1.805; 2,116). Compared with batik SMEs that are not active in product innovation, marketing innovation and business alliances (price efficiency = 1.754; 1,750; 1,708).
- d. Batik SMEs are more active in product innovation, marketing innovation and business alliances in general have a higher economic efficiency (efficiency price = 1,820; 1,612; 1.915) compared with inactive batik SMEs in product innovation, business alliances and marketing innovation (price efficiency = 1.570; 1.568; 1,528).

## 5. Discussion

The results found that the three factors of production costs consist of labor costs, raw material costs and fixed costs affect the production and sale of batik SMEs. The elasticity of labor costs is greater than the elasticity of raw and auxiliary materials costs and fixed costs. The results of data processing to find the average value of technical efficiency of SMEs batik 0.885. This shows the level of efficiency achieved by batik entrepreneurs approaching a maximum value or 1 (reaching 88.5). The results of the calculation of the efficiency of the price obtained a value of 1.794. This shows that the use of production factors labor, raw and auxiliary materials and cost efficient manner apparently fixed price. From the calculation of economic efficiency obtained yield was 1.588, this means batik SMEs in three research areas already economically efficient.

Based on calculation result of Return to Scale (RTS) on batik SMEs found result as many as 1,081. Based on this result, return to scale number more than 1 which mean in the increasing return to scale situation, this means if this means that if there was an additional factor of production by 1%, it will increase production output amounted to 1,081, with the result that more than 1, then the condition of batik SMEs in the study area is feasible to develop or continue. This is consistent with previous research conducted by NetFinTex, (2013) who found batik SMEs have the potential to be developed as an industrial base in the long run. The potential of the Indonesian market for commodities is relatively large for the needs of the textile fabric of urban communities not only in the form of clothing, but also the needs of non-clothing (Hermawan, 2011).

The results of this study also found the role of entrepreneurship in innovation such as through the development of design, collaboration with designers and management quality (D1) has a positive effect on the sales value of batik (Y) (t value 2.660 (p-value = 0.009 <5%)). Similarly, the role of entrepreneurship in business alliances such as through partnerships with large industrial or through cooperatives (D2) and marketing innovation such as through participation in exhibitions and marketing via the internet (D3) has a positive effect on the sales value of batik (Y) (t value 2.138 and 2.660 (p-value = 0.035 and 0.000 <5%). This means that in the long run, SMEs are not only able to batik production capability to be rely on tradition as a source of uniqueness to compete in the local market, domestic and global markets, the results accordance with the results of previous studies that found by Harvie (2004) who does so that SMEs should have a design that is dynamic and competitive, understand quality control, to understand environmental issues such as eco-design and eco-labeling, understand export procedures, have economies of scale efficiency in addition to technical and other management controls such as entrepreneurial, managerial, accounting and marketing.

Results of regression testing is also obtained results that the entrepreneurial role and a significant positive effect on production and sales. In this case a more intensive small industry in the activities in product innovation, marketing innovation and business alliances have tended to have production and sales. This is consistent with previous studies (such as done by done by: Roberts and Amit, 2003; Mogollon and Vaquero, 2004; Marques and Monteiro, 2006; Marques & Ferreira, 2009) that found an association role on the performance of entrepreneurial behavior. Behavior innovation and entrepreneurial business alliances help companies to increase their resources and market differential, this strategy required to produce higher performance (superior) than competitors.

## **6. Conclusion**

Based on the regression results of data processing with the result of variable costs of labor, raw and auxiliary materials and overhead costs have a significant influence on the value of the production and sale of batik SMEs. The cost of labor has the highest elasticity of the production and sale of batik SMEs followed by the cost of raw and auxiliary materials and overhead costs. Average level of technical efficiency of SMEs batik close to 1 (0,885 or 88.5%), but the efficiency and economical prices more than 1 price efficiency (allocative) and economic research on the value is greater than 1, is equal to 1.794 and 1.558 were means efficient use of production inputs yet the price. Economic efficiency and a low price indicate the benefit is not worth the cost incurred. Gains derived only to cover the cost of production.

The role of entrepreneurship in product innovation, marketing and business alliances have a positive impact on sales value of batik. The role of entrepreneurship in marketing innovation has the highest elasticity of the production and sale of batik SMEs followed by the role of entrepreneurship in business alliances and product innovations. The role of enterpreneur is important especially in economic efficiency and price.

Based on research result and discussion, the suggestion that researchers can provide are

as follows:

- a. In the long term, batik SMEs to compete in the local market, domestic and global markets can not only rely on the production capability mangakar on tradition as a source of local uniqueness, capital subsidies, market access assistance, as well as short-term training, but must have the economies of scale efficiency, has the quality of resources, competence in the field, independent and has a strong brand in the local market and global.
- b. Development of SMEs Centre is a showroom of batik SMEs products to enhance the role of batik entrepreneurs in market access, product design innovation, quality, environmental impact and capital assistance.
- c. Local governments can provide incentives and guidance system to spur the development of new businesses to access markets, technology incubators and business development, as well as providing support for the development of partnerships between small businesses.
- d. The role of entrepreneurship in product innovation, marketing and business alliances have a positive impact on sales value of batik, so it needs to be improved, especially in the design innovation, product innovation, quality innovation, anticipate change and environmental impacts, establish partnerships, especially in accessing assistance and access to capital markets.

The implication of these results is that the batik SMEs to compete in the local market, domestic and global markets can not only rely on the ability of production rooted in tradition as a source of local uniqueness, capital subsidies, market access assistance, and short-term training, but the long term must have economies of scale efficiency, having competent in their field resources quality, independent and has a strong brand in the local market and global. In the other hand, economies scale make SMEs inefficient to adopt the technology, access to infrastructure, building a brand, paying a professional (such as managers, accountants, designers, research and development), so that an obstacle to competitive in the long term. SMEs must overcome efficiency of economies of scale by cooperative / group both in clusters and business networks, building vertical alliances in a group of related businesses, or employ agents both through resource acquisition and contract-based. SME Center development is a showroom of SMEs batik products to enhance the role of batik entrepreneurs in market access, product design innovation, quality, environmental impact and capital assistance. Local governments can provide incentives and guidance system to spur the development of new businesses to access markets, technology incubators and business development, as well as providing support for the development of partnerships between small businesses.

## **Unknowldgement**

I say thank you to the Ministry of Education and Culture of the Republic of Indonesia which has provided Fundamental Research Grants in 201, hopefully these results useful for the development of science and technology and has an impact on the development of Indonesian batik business.

## REFERENCES

- Audretsch dan Keilbach. 2007. Entrepreneurship Capital-Determinan and Impact on Regional Impact Performance. Journal MPI Jena ISSN 1813-8333
- Barney, J. B. (2002), *Gaining and Sustaining Competitive Advantage* 2nd ed., Upper Saddle River, NJ: Prentice Hall.
- Chavas, J.P dan Barham, B. (2007) On Microeconomic Efficiency and Entrepreneurship under Bounded Rationality. RePEc:ecl:wisagr:516. <http://www.aae.wisc.edu/pubs/sps/pdf/stpap516.pdf>
- Ministry of Industry and Trade. 2013. *the Small Industries Development Policy Guidelines*, Jakarta.
- Hamel, G., & C. K. Praharad (1994), *Competing for the Future*, (Boston, MA: Harvard, Business School Press Citation by Tokuda, A. (2005) *The Critical Assessment of the Resource-Based View of Strategic Management: The Source of Heterogeneity of the Firm*. Institute of International Relations and Area Studies, Ritsumeikan University
- Harvie, C, (2004), *East Asian SME Capacity Building, Competitiveness and Market Opportunities in a Global Economy*, Working Paper 04-16, Department of Economics, University of Wollongong,
- Herman (2011), *Analysis of Impact of Macro Economic Policy Against Development of Industrial Textiles and Textile Products Indonesia*. Buletin Monetary Economics and Banking, April: 374-408
- Kirzner, I., (1973), *Competition and Entrepreneurship*. Chicago: University of Chicago Press.
- Mankiw, G., 2008. *Principles of Economics*. Third Edition. McGraw-Hill
- Grønning (2008) *Entrepreneurship and Innovation Organizations, Institutions, Systems and Regions*. Paper to be presented at the 25th Celebration on Conference Copenhagen, CBS, Denmark, June 17 – 20
- Nelson, R. R., & Winter (1982), *An Evolutionary Theory of Economic Change* (Cambridge, MA: Belknap Press of Harvard University Press) the Citation in Tokuda, A. (2005) *The Critical Assessment of the Resource-Based View of Strategic Management: The Source of Heterogeneity of the Firm*. *Institute of International Relations and Area Studies, Ritsumeikan University*
- NetFinTex (2013), *Opportunities and Challenges for Financing Innovation in the European Textile and Clothing Industry*. The Online access: [http:// www.netFinTex.com](http://www.netFinTex.com)
- Pasay, NH A, Sugiharso, Ngurah, A., 2008, *Micro Economic Theory: An Analysis of Applied Production*, Eagles Press, Jakarta
- Schumpeter, 1934, *Theory of Economic Development*, Cambridge, Harvard University Press.
- Teece, D. J, Pisano, G., & A. Shuen (1997), *Dynamic Capabilities and Strategic Management*, *Strategic Management Journal* Vol. 18, No.7, pp.509-33.
- Zheng, Jianghuai and Hu, Zhining and Wang, Jialing (2008) *Entrepreneurship, Innovation and Economic Growth: The Case of Yangtze River Delta in China*. *MPRA paper 8919*. <http://mpra.ub.un>

# **COOPERATIVES BUSINESS PROFITS DETERMINANT IN INDONESIA: A PARTIAL LEAST SQUARES APPROACH**

**<sup>1</sup>Ghazali Syamni**

<sup>1</sup>bujangsalim88@gmail.com, 081269664164

## **Abstract**

The purpose of this study was to test cooperatives business profits determinant in Indonesia. This study used cooperative profile data in 33 provinces in 2012-2013 published by the Ministry of Cooperatives and Small and Medium Enterprises Indonesia. Data analysis model is path analysis model using Smart. PLS 4.0 to process the data. The study found that cooperatives in Indonesia is very dependent on the employee. This indicates that cooperatives in Indonesia, during its development, are highly dependent on the employee, not a member, manager or capital.

**Keywords:** determinant, cooperatives, Indonesia

## **1 Introduction**

Cooperative development in Indonesia has grown rapidly. Data from the Ministry of Cooperatives and 2013 SMEs stated the development of cooperatives in Indonesia. There were 203.701 cooperatives, of which 143.117 were active and 60.584 cooperatives were not. In other words, 70% were still performing well and 30% did not. The number of cooperative members increased from 33,841,539 people in 2012 to 35,258,176 people in 2013. Number of manager, however, decreased to 35.063 people from previously 36.149. In addition, the amount of equity capital of cooperatives in Indonesia reaches from 51,422,621 (millions rupiah) into 89,536,290.61 (millions rupiah). Foreign capital now amounted to 80,840,572.48 (millions rupiah) from previously 98,763,516 (millions rupiah). While the business volume in 2012 amounted to 119.182.433 (million rupiah) to 125,584,976.2 (millions rupiah) in the next year. Profit was 8.118.959.29 (millions rupiah) which increased from the previous year in 2012 amounted to 6.661.925 (millions rupiah).

Cooperative is one form of business entity intended for the welfare of its members. The form of welfare is the provision of profit to all members after it was decided in the Annual Members Meeting fairly. In this Annual Member Meeting, all members, administrators, supervisors (managers) are invited to a meeting to discuss cooperative issues and profit distributed and retained as capital for the cooperative.

Royer and Smith (2007) says that the cooperative would restore the earned income to its members, or the number of patrons that will be allocated to members and can also be saved for use as a future capital. Although cooperatives are not prioritizing profits, businesses must obtain cooperatives business profits (BP) is feasible so that cooperatives can maintain its viability and enhance business capabilities. Wahyuning (2013) says that the cooperative is a company that should be able to stand alone to run its business activities to earn profits or revenues, known as the BP. In Act No. 25 Article 45, Paragraph 1 of 1992 states that the BP is a cooperative income earned within one year reduced the costs, depreciation, and other obligations, including in the tax year concerned. Income or cooperative profits is highly dependent on two aspects, namely the financial and non-financial aspects (Syamni, 2014a:2014b; Wahyuning; 2013; and Atmadji; 2007)

Furthermore, many studies that examine each variable of financial and non-financial aspects of the business revenue. Antara and Komenaung (2007) using a structural equation model approach, the performance of Cooperatives village in the province of Bali. Sagala and Made (2012); Pudjilestari (1999) analyze the performance of cooperative balanced scorecard approach. Ayuk (2013) studied the effect of number of members, number of deposits, loan amount and the amount of working capital to the rest of the results of operations of savings and Credit Cooperatives in Badung Bali Province. Sari and Susanti (2012) examine the effect of its own capital, external capital, and the business volume of net income of Cooperatives in the province of Yogyakarta.

From the above discussion, it shows that not many previous studies that examine the use of the volume of business as an intervening variable. This study extends previous research that has been done especially by Lukman (2011) studied the effect of the amount of equity and the amount of outside capital to variable volume cooperative profits through the Efforts of Cooperatives in the city of Lhokseumawe. This study consists in the following sections: Section 1 is an introduction; Section 2 of the literature review; Section 3 methods of research; Section 4 the results and the last section conclusions.

Under Act No. 25, 1992 and Act No. 17, 2012, two aspects have been mentioned namely; financial and non-financial aspects (Syamni, 2014a: 2014b; Wahyuning; 2013; and Atmadji; 2007). Detail of these aspects explain that the number of members, the number of managers and supervisors (manager), equity and foreign capital and the volume of business and operating results. Of all the items aspects Cooperative Profits are the main goal of cooperative establishment; welfare of its members.

## **2 Literature**

In Act No. 25, 1992 and Act No. 17, 2012 on the cooperative, it was mentioned that the indication of the direction of financial and non-financial aspects. The financial aspect is composed of its own capital, external capital or foreign capital. While the financial aspects of a number of board representation, the number of inspectors and the number of members. Essentially, cooperatives have the same effort with other financial management services, including distribution economic benefits and oversight through the balance sheet and income statement to see the company generating profit / of net income (Mc Kee, 2008).

Atmadji (2007) put the number of members, the development of a cooperative effort reflected by the financial and non-financial indicators. Cooperative financial indicators, capital itself, outside the capital / foreign, and the business volume of net income. non-financial indicators is the number of members, number of employees, business units cooperativ. The existence of Reviews These two aspects makes the cooperative managed to meet the welfare of its members. Cooperatives have been successful is that effective and sustainable cooperative accomplishes two goals at once items, namely enhancing the ability to serve members and the make more economical cooperative, competitive and innovative (Bello, 2005). From various sources can be concluded that there are two important factors in developing a cooperative financial and non-financial or human resources.

Many studies have been conducted to meguji factors affecting both Cooperative Profits cooperative in various regions in Indonesia. However, these studies have not been used much as intervening variables (Rusdarti, 2009; Sari and Susanti, 2012; Ayuk, 2013; Syamni, 2014a; 2014b and Lukman, 2011).

Rusdarti (2009) examined the effect of the involvement of supervisors, the ability of the board and the participation of members of the cooperative financial performance boarding school. Her findings, among others, are the responsibility of the board to run the Kepontren organization is large enough, founder should note well aspect of prosperity increase through an additional incentive to be motivated

in their work and devote his time as possible for the development kopontren. Sari and Susanti (2012) examined the effect of its own capital, outside the capital, and the volume of business in the rest of the results of cooperative efforts in Yogyakarta Province. Their research found that internal capital, outside the capital, and business volume together affect the BP, while partial volume only affect BP cooperative effort. In addition it was found that the contribution of the influence of their own capital, outside the capital, and the volume of the BP cooperative effort amounted to 95.90%, while the rest influenced by other aspects that are not included in the research model

Ward (2013) when analyzing the financial performance of savings and loans units Employees Cooperative Republic of Indonesia at UB. Syamni (2014a) examined the effect of financial and non-financial aspects of the business volume in the BP through savings and credit cooperatives in North Aceh. Research results found that the financial aspect is very important in the BP compared with the non-financial aspects of the credit union. While Syamni (2014b) examine that examined the influence of financial and non-financial aspects of the BP cooperative leading sectors in North Aceh. The results of the same study conducted by Syamni (2014a) means more dominant financial factors play a role in improving the Cooperative Profits. While Atmadji (2007) examine the effect of financial and non-financial aspects of the Cooperative Profits in Indonesia period 2002-2004. The study found that both financial and non-financial aspects affecting the performance of cooperatives in Indonesia.

Ayuk (2013) examined the effect of number of members, the amount of deposit, loan amount and the amount of working capital to the rest of the results of operations of credit unions (KSP) in the Badung regency of Bali Province. The results found that. Variable number of members, and a number of working capital partially positive and significant effect on net income credit unions in Badung, while variable number of savings and loan amount have no effect. Variable amount of working capital the most dominant effect on net income credit unions in Badung. Lukman (2011) examined the effect of the amount of equity and the amount of outside capital to BP through a variable volume of business on cooperatives in the town of Lhokseumawe. The results showed the use of capital drain large portion of BP because of the large volume of business that is used to finance outside parties cooperative.

### **3 Research Method**

#### **Data**

This study uses data cooperatives in 33 provinces from the period 2012 and 2013 issued by the Ministry of Cooperatives and SMEs in Indonesia. The cooperative data are secondary data consists of data on the number of members, number of employees, number of managers, equity, foreign capital (outside the cooperatives), the volume of business and operating results.

#### **Operational Definition of Variables**

The operational definition of variables can be seen in Table 1 below were obtained from the Cooperative Act No. 25, 1992. From the problems, two variables are found exogenous and endogenous.

**Table 1 : Operational Definition of Variables**

<b>Variables</b>	<b>Definition</b>	<b>Remark</b>
Member (M)	The owner and user of cooperative and recorded in cooperative register	Exogenous
Employee (E)	Cooperative employee either in dealing with cooperative organizations or businesses and earn salary from cooperative	Exogenous
Manager (MG)	Persons appointed by the board to manage the cooperative	Exogenous
Internal Capital/ Equity (IC)	Capital of cumulative savings, compulsory savings, reserve funds and grants	Exogenous



External Capital (EC)	Cooperative capital borrowed from cooperatives members, banks and financial institutions, bonds/ securities and other sources	Exogenous
Business Volume (BV)	The total value of sales volumes or revenues of goods and services in the financial year concerned	Endogenous 1
Business Profits (BP)	Business Profits (BP) cooperative Income earned in a fiscal year is reduced by the cost, depreciation, other liabilities including taxes in the fiscal year concerned	Endogenous 2

**Source:** cooperative Act No 25, 1992.

### Data Analysis Model

This study examines the complex causal relationships and tiered involve endogenous variable which are number of members, number of employees, number of managers, the amount of equity capital, and foreign capital. Whereas exogenous variables, namely the volume of business and operating results. With above problems, silmutanus equation with path analysis estimation technique is used (Hair et al., 2006). Smart application program. PLS version 4.0 is helpful in analyzing the data in this study. In addition, the use of PLS method because this research is the prediction research to support the theory that is still weak and limited data.

## 4. RESULT

### Data Description

Based on the data obtained, it showed that the cooperative Indonesia has experienced rapid growth. Especially from capital or funds used to build the economy in the form of cooperatives in Indonesia (Table 2)

**Table 2. Description of Financial and Non-Financial Aspect of Cooperatives in Indonesia**

Item	IC (MS)	EC (ML)	M (A)	E (K)	MG (M)	BV (VU)	BP (SHU)
Jumlah: 2013	89.536.291	80.840.572	35.258.176	438.541	35.062	125.584.976	8.118.959
Average	2.713.221	2.449.714	1.068.429	13.289	1.062	3.805.605	246.029
Jumlah: 2012	51.422.621	98.763.516	33.841.539	386.383	36.149	119.182.433	6.661.925
Average	1.558.261	2.992.834	1.025.501	11.708	1.095	3.611.589	201.877

**Remark: IC, EC, BV dan BP (million rupiah)**

Source: Data processed 2015

Based on Table 2, it can be explained that the two years of study from 2012 to 2013 showed an increase every year except manager that declined. There was an increased in internal capital (equity) by 38,113,670. External capital decreased by 17,922,944, the number of members increased by 1,416,637 people, the number of employees increased number of 52.158 people, the business volume increased by 6,402,543 and 1,457.034 BP except number of managers decreased by 1,504 people.

### Evaluation Model: Inner models

*Goodness of Fit* testing models in the *inner structural* model using the R-square value (Sheng, 2006) The value of R-square is used to see the significance of latent variables. In Inner testing the model showed the R-square of business volume (Y1) is 0.926, meaning that 92.6% of business volume variable is influenced by variables ML (EC), MS (IC), A(M), K(E), M (MG), and the remaining 7.4% is influenced by other factors outside of this research . Furthermore, for the results of the R-square BP variable (Y2) is 0.443%, meaning that 44.3% of BP variables are influenced by variables EC, IC, M, E, MG and BV and the remaining 55.7% is affected by variables outside of this research.

**Table 3. The coefficient of Determination R Square**

	R Square
<b>A</b>	
<b>K</b>	
<b>M</b>	
<b>ML</b>	
<b>MS</b>	
<b>SHU</b>	0.442912
<b>VU</b>	0.925618

Source: data processed, 2014

Measurement of relevance predictions (predictive relevance) of the endogenous latent variable indicators to assess the magnitude reflexive square Q (Q<sup>2</sup>), wherein a latent variable has a good predictor relevansi when having Q<sup>2</sup> > 0. In this study the amount of Q<sup>2</sup> can be calculated as follows: Q<sup>2</sup> = 1 - (1 - RI<sup>2</sup>). From the equation above, the value of Q<sup>2</sup><sub>12</sub> = 1 - (1 - 0.4432) = 1 - (1 - 0.196) = 1 - (0.804) = 0.196 and Q<sup>2</sup><sub>22</sub> = 1 - (1 - 0.9232) = 1 - (1 - 0.852) = 1 - (0.148) = 0.852. Based on test results Q<sup>2</sup><sub>12</sub> and Q<sup>2</sup><sub>22</sub> obtained values are 0.196 and 0.852, means that the model in this study has a good prediction, because nilai Q<sup>2</sup> > 0, which means having a good prediction of the latent variables endogenya.

### HIPOTHESES TESTING

Accepting and refusing limit 1 and 2 an be seen from the statistical criteria at t-score > 1,96 (Latan and Ghozali, 2007). Detail can be seen in the regression table below:

**Table 4. Result of Smart PLS**

Total Effects (Mean, STDEV, T-Values)

	Original Sample (O)	Sample Mean (M)	Standard Deviation (STDEV)	Standard Error (STERR)	T Statistics ( O/STERR )
<b>A -&gt; SHU</b>	-0.037910	0.047294	0.333212	0.333212	0.113771
<b>A -&gt; VU</b>	-0.056963	0.042233	0.409890	0.409890	0.138972
<b>K -&gt; SHU</b>	0.735545	0.444625	0.306423	0.306423	2.400423
<b>K -&gt; VU</b>	1.105224	0.652899	0.448175	0.448175	2.466056
<b>M -&gt; SHU</b>	-0.032135	-0.001870	0.158420	0.158420	0.202850
<b>M -&gt; VU</b>	-0.048287	-0.015830	0.197703	0.197703	0.244238
<b>ML -&gt; SHU</b>	-0.006647	0.055728	0.180384	0.180384	0.036849
<b>ML -&gt; VU</b>	-0.009988	0.078500	0.232483	0.232483	0.042961
<b>MS -&gt; SHU</b>	-0.040345	0.146368	0.328871	0.328871	0.122676
<b>MS -&gt; VU</b>	-0.060622	0.185343	0.413659	0.413659	0.146550
<b>VU -&gt; SHU</b>	0.665517	0.733889	0.165223	0.165223	4.027982

Source: Data processed, 2014

Based on table 4 above, it can be explained that only variable E that has significant influences on variable BV with 1,1052. While variables EC, IC, M and MG have no significant effect on BV. As for BP, variable E has significant effect on BP with 0,3755 and variable BV with 0,6655. While variable EV, IC, M and MG have no significant effect on variable BP.

### **Determination Business Volume and Cooperatives' Business Profits in Indonesia**

The results of the study addressed that cooperatives in Indonesia is still very dependent on employees or managers to increase business volume and BP. This can be seen from the output estimate coefficients Smart PLS where only employees or executives who have a significant value of 2,466 and 2,400. The findings indicate all cooperative institutions in Indonesia is less participative to promote the cooperative. In other words, the members of the cooperative entrusted the effort to managers (employees).

Other findings from this study that the cooperative BP is determined by the volume of the cooperative effort. And the volume of business is strongly influenced by the performance of the employees of cooperatives instead of the source of funding and resources from members and managers of cooperatives. In other words, the better employees' effort and work the higher the volume received by the cooperative effort, ultimately boils down to the higher BP cooperative in Indonesia. The results of the study support the research Rusdarti (2009) who studied at boarding cooperative stating that the management responsibility in running the organization kopontren large enough, it needs to be considered properly by the builder is increased prosperity for the board through an additional incentive to be motivated in their work and devote his time as good possible for the development kopontren. However, the results of this study differ from previous studies, such as: Sari and Susanti, 2012; Ayuk, 2013; Syamni, 2014a; 2014b and Lukman, 2011). Where the research they find capital or financial factors more dominant influence perkembangan BP cooperative.

### **3. CONCLUSION AND IMPLICATION**

This study provides understanding of determination of cooperatives BP in Indonesia using data 33 cooperative ministry in 33 provinces owned by the Ministry of Cooperatives and SMEs of the Republic of Indonesia. The study found that cooperatives run by the department of cooperatives and SMEs in 33 provinces Indonesia still very dependent on cooperative management. The rest of the results of cooperative efforts is dependent upon cooperative management. Cooperatives with active management will likely have better BP. High BP is of course is desired by members of the cooperative. The higher the BP, the higher remuneration received by the members of the cooperatives and makes them more prosperous.

Implications of these findings that cooperatives should have administrators who work and berpartisipasif should be granted or considered to be given better bonus. This motivates them to work better so cooperative BP will increase even more. While the members of the cooperative whose numbers are so great should be given knowledge about cooperatives better. This will encourage them to pro-actively elicits cooperative if their participation is certainly well made cooperative BP is better. These members seem large amounts but like still asleep or not moving. In addition, the cooperative manager 1600's numbers should be given the understanding and knowledge that they have the intention to work for the development and progress of the cooperative is not just so the position of manager. The last of the financial aspects of both equity and external or foreign Mudal need to be used as best as possible for the development of cooperatives. Many of his amount of money possessed if not utilized for productive things for members certainly will not accelerate the development of cooperatives so do not just ignored. On the other hand, distributed to the members or prospective businesses better to add cooperative BP in Indonesia.

## 5 References

### Journal Paper Reference

- Antara, Made dan Komenaung, Anderson Guntur.(2007). *Kinerja Koperasi Unit Desa di Provinsi Bali: Pendekatan Structural Equation Model*. [ojs.unud.ac.id](http://ojs.unud.ac.id) › [Home](#) › [Vol. 7, No. 3 November 2007](#) › [Antara](#)
- Atmadji, (2007). Aspek-aspek yang menentukan Besarnya Sisa Hasil Usaha Koperasi dari Aspek Keuangan dan Non Keuangan, *Jurnal Bisnis dan Manajemen*, Vol.7, 217-232
- Ayuk, Ni Made Taman dan Utama I Made Suyana. (2013). Pengaruh Jumlah Anggota, Jumlah Simpanan, Jumlah Pinjaman dan Jumlah Modal Kerja Terhadap Sisa Hasil Usaha Koperasi Simpan Pinjam Di Kabupaten Badung Provinsi Bali. [ojs.unud.ac.id/index.php/EEB/search/titles?searchPage=2](http://ojs.unud.ac.id/index.php/EEB/search/titles?searchPage=2)
- Bello. (2005). The Role of Cooperative Societies in Economic Development. Online at <http://mpira.ub.uni-muenchen.de/23161/>. Ahmadu Bello niversity, Zaria-Nigeria
- Lukman.(2011). Pengaruh Jumlah Modal Sendiri dan Jumlah Modal Luar Terhadap Sisa Hasil Usaha Melalui Variabel Volume Usaha Pada Koperasi-Koperasi Di Kota Lhokseumawe. *Ekonis*, Vol.10 No. 1.pp.1-11
- McKee, Gregory. (2008). The Financial Performance of North Dakota Grain Marketing and Farm Supply Cooperatives, *Journal of Cooperatives*. Volume 21, Pages 15-34
- Pudjilestari, Sri Indrarti.(1999).Pengukuran Kinerja Koperasi: Studi Kasus pada Koperasi Pegawai Departemen Koperasi, Pengusaha Kecil dan Menengah Dengan Pendekatan Balanced Scorecard. <http://lontar.ui.ac.id/opac/themes/libri2/detail.jsp?id=75874&lokasi=lokal>
- Royer, Jeffrey S dan Smith, Darnell B .(2007). Patronage Refunds, Producer Expectations, and Optimal Pricing by Agricultural Cooperatives. *Journal of Cooperatives*. Volume 20, Pages 1-16
- Rusdarti.(2009). Pengaruh Keterlibatan Pembina, Kemampuan Pengurus dan Partisipasi Anggota terhadap Kinerja Keuangan Koperasi Pondok Pesantren. *Jejak*, Vol. 2, No. 1, Maret
- Sagala, Martaulina, Ginarsa dan Made Antara Wayan. (2012). Kinerja Koperasi Unit Desa Ulun Tanjung Desa Kerobokan, Kecamatan Kuta Utara, Kabupaten Badung (Ditinjau dari *Balanced Scorecard*). *E-Jurnal Agribisnis dan Agrowisata*, ISSN: 2301-6523 Vol. 1, No. 2, Oktober
- Sari, Agustin Rusiana dan Susanti, Beny.(2012).The Influence of Own Capital, Loan Capital and Business Volume on Added Value of Cooperatives in Yogyakarta Special Province.
- Sheng, H. H. (2006). Robustness Testing Of PLS, LISREL, EQS And ANN-Based SEM for Measuring Customer Satisfaction, Total Quality Management. *Journal Bussines Chung-Hua University*. 17(3): 355–371.
- Syamni, Ghazali. (2014a). Pengaruh Faktor Keuangan dan Non Keuangan terhadap SHU Koperasi Perkebunan, Pertanian dan Perikanan di Kabupaten Aceh Utara, Prosiding Seminar Nasional, Universitas Negeri Surabaya
- Syamni, Ghazali.(2014b). Effect financial and nonfinancial aspects to value of business through the volume of business In cooperative savings and credit. Proceeding, ICERI, UNY, Yogyakarta
- Wahyuning, Titi. (2013). Beberapa Aspek yang Mempengaruhi Sisa Hasil Usaha (SHU) di KPRI “Bina Karya” Balongpanggang-Gresik, *Jurnal Ekonomi Bisnis*. Volume 01 Nomor 01, 0 – 88

## **Reference**

Latan, Henky dan Ghozali, Imam. 2012. *Partial Least Squares: Konsep Teknik dan Aplikasi Untuk penelitian Empiris*. Badan penerbit Universitas Diponegoro, Semarang

Undang-undang Republik Indonesia Nomor 17 Tahun 2012 tentang Perkoperasian, [www.Hukumonline.com](http://www.Hukumonline.com)

Undang-Undang Republik Indonesia Nomor 25 Tahun 1992 Tentang Perkoperasian, [www.Hukumonline.com](http://www.Hukumonline.com)

*Hair, J.F. JR., Anderson, R.E, Tatham, R.L. & Black, W.C. (2006). Multivariate Data Analysis. Six Edition. New Jersey : Pearson*

# THE DETERMINANT FACTORS OF SECTORAL STOCK RETURN IN BULLISH AND BEARISH CONDITION AT INDONESIAN CAPITAL MARKET

Defrizal  
Universitas Bandar Lampung. Email : [defrizal\\_ubl@yahoo.com](mailto:defrizal_ubl@yahoo.com). Ph. 08127202194

## ABSTRACT

This study aims to explain determinant factors of sectoral stock return in bullish and bearish condition at Indonesian capital market. This study used a multi-factor asset pricing model with sectoral stock return as the dependent variable and stock market return,, interest rates, and exchange rate as independent variables. The Identification of stock market condition by using a Markov Switching Models, which are also used as the basis for segmenting the data into bullish and bearish conditions. Estimates of the model used the robust least square method. This study used data from Indonesian Stock Exchange to the observation period from January 1996 to December 2013.

The results of this study were (1) Simultaneously, stock market return, interest rates, and exchange rate affected the sectoral stock return in bullish and bearish condition. (2) Partially, the stock market return positively effect and is as a main factor in determining the sectoral stock return in all industries in either bullish condition or bearish condition, while the effect of the interest rates and exchange rate do not consistently affect the sectoral stock return in different industries and market conditions.

*Key word: Market Condition, Multi Factor Asset Pricing Model, Markov Switching Model, Robust Least Square*

## BACKGROUND

There is a widespread belief among the investors, policy makers and academicians that the low-frequency trend exists in the stock market. Traditionally, the positive and negative trends of low frequency have been known respectively as bullish and bearish. If these trends exist, it is important to extract them from the data, analyze their characters and consider their uses as the input for investment decision and risk assessment (Maheu et al, 2012).

Bullish is generally understood as a long period of gradual price increases while Bearish is characterized by falling prices. Stock market volatility tends to be higher when prices are falling. It provides another difference between bullish and bearish. Besides, asset prices behave quite differently during the period of bullish and bearish, then the investment risk varies depending on market sentiment (Kole et al, 2012).

Based on the belief that the behavior of stock prices in a bullish condition is different from the bearish condition, a lot of researches have been conducted as it is done by Fabozzi et al. (1977); Kim et al. (1979), Chen, (1982), Khalid et al. (2013). These researches use a simple method based on the cut-off point in the determination of bullish and bearish conditions to the use of more sophisticated econometric methods such as using a Markov switching model conducted by Hamilton (1989), Schwert (1989) and Hamilton and Susmel (1994) Turner, et al (1989), Ang and Bekaert (2002) and Guidolin and Timmermann (2004), Ismail, et al, (2008), Martin P.H. Panggabean (2010) and Kole et al. (2012).

Several studies have been conducted in determining bullish and bearish regime by referring to some previous researchers such as, Fabozzi et al. (1977); Kim et al. (1979) and Chen, (1982) which defines a simple bullish and bearish. This definition does not reflect the dependencies of the stock price in the long term and ignores the information about trends in the level of stock prices (Lunde et al., 2004).

Financial time series data, especially the stock price, has always had an episode in which the behavior of series seems to change quite dramatically due to the economic crisis and finance. This

phenomenon refers to regime shifts or structural breaks and can not be modeled by the linear time series model of a single equation, and this condition is motivating the use of regime switching models. The stock market condition is very closely related to the economic conditions of a country. Changes in economic conditions will affect the stock market that make an uncertainty for investors to invest their funds.

Some researchers tried to connect the stock return with some common risk factors, such as the stock market return (Sharpe, 1964; Butt et al, 2010), interest rate, (Maysami et al., 2000; et al., 2004; Gan, et al 2006) and the exchange rate (Maysami et al., 2000; Gan, et al, 2006). Based on these studies, these variables are associated with stock returns and used to predict stock returns.

In connection with an investment in the common stock, the investors will be exposed to a wide selection of industrial sectors. An analysis of sectoral investment is important to be conducted to make it easier for investors in determining the investment option (Jones, 2007).

All listed the issuers on the Indonesia Stock Exchange (IDX) are classified into nine sectors. They are: agriculture, mining, basic industry, miscellaneous industry, consumer goods, property and real estate, infrastructure, finance, trade and service. In this paper, the author limits only to the financial sector and trade and service sector. The author considers that these sectors are the highest number of issuers than other sectors with 78 issues (16%) and 111 issues (23%).

## LITERATURE REVIEW

Arbitrage pricing model (APT) is a theory developed by Stephen A. Ross in 1976. The APT model is also called a risk factor model. APT states that the expected return of certain assets is based on the sensitivity of the assets on one or more systematic factors (Meggison, 1997)

Bodie et al. (2009) states that it explicitly indicates the possibility of a different sensitivity to systematic risk and different stocks. Therefore, models that allow the multiple factors or multi-factor models can give a better description for stock returns

The linkage between stock returns with economic factors is based on two reasons. The stock price is a reflection of the expectations of profits, dividends and interest rates. Therefore, the investors are trying to estimate this variable. The second, capital markets react to various major indicator sets or leading indicators, so that the investors are trying to adjust the stock price with the expectation of leading indicators variety (Brown and Reilly, 2009).

The selection of these factors is based on the consideration that these factors can affect directly or indirectly on cash flow and discount rate of investment activities as well as investment interest investors. These variables are as follows: stock market return (MR), interest rates (IR) and exchange rate (ER).

The previous research has seen the stock price as the dependent variable on the market return only when it tries to explain about the effect of the up and down market and at ordinary stock price (Fabozzi et al. (1977). This research has been carried out using the single factor CAPM modifications to the model to be separated exposures of individual stocks in both market trends, up market and down market

Fabozzi and Francis (1977) reached the conclusion that the level of market optimism did not significantly affect either the intercept and the slope of the regression coefficients, this study found that the null hypothesis of did not have any interaction with the type of market was correct.

Khalid, et al (2013) conducted research on the Stock Exchange Karachi, Pakistan, by using the model formulated by Fabozzi and Francis (1977). Their research results concluded that all stocks in the oil sector showed a significant beta difference between bullish and bearish conditions, while in banking sector, the three out of eight stocks refused showed no difference. The results of this study indicate that stock returns might have the different response to factors affecting the different stock market conditions.

In this paper, the author uses multiple factors asset pricing model to see the determinant factor of sectoral stock return in different market conditions. They are bullish stock market condition and bearish stock market condition.

The determination of the factors that affect stock returns is based on some of the researchers who try to connect the stock return with some common risk factors, such as the stock market return (Sharpe, 1964 and Lintner, 1965, Butt et al, 2010), interest rates (Maysami et al ., 2000; Maysami et al., 2004; Gan, et al, 2006), and exchange rate (Maysami et al., 2000; Gan, et al, 2006). From these studies, these variables are associated with stock returns and used to predict stock returns.

Turner et al (1989), Maheu, et al (2000), Ismail, et al (2008), Martin PH. Pangabea (2010) and Kole et al. (2012) can capture non-linear structure in the mean and variance of return by using a

Markov-switching models. The model returns sorting into two conditions, namely high returns and stable condition, and low and volatile returns condition, which are then labeled as bullish conditions (high returns and low volatility) and bearish conditions (low returns and high volatility).

## METHODOLOGY

Parametric method which is based on Markov Switching Model (MSM), was introduced in finance by Hamilton (1989). Hamilton and Lin (1996); Turner et al. (1989), Maheu et al. (2000), Ismai, et al. (2008), Chen (2009), Martin PH. Pangabea (2010), Kole et al. (2012) to identify the regime of bullish and bearish on the stock market.

$r_t$  = stock market return at t time, is calculated from the logarithmic change of IHSG<sub>i</sub> ( $Y_{it}$ )

$$r_t = 100 \cdot \ln(Y_{it}/Y_{it-1})$$

$S_t = i$ , is variable market conditions,  $i = 1; 2$

$S_t = 1$ , bullish condition

$S_t = 2$ , bearish conditions

Then the Markov-Switching Model with two conditions (two-state Markov Switching Model), which describes the evolution of the data  $r_t = \{r_1, r_2, r_3, \dots, r_t\}$  is as follows:

$$R_t = \mu_1 S_t + \mu_2 (1 - S_t) + [\sigma_1 S_t + \sigma_2 (1 - S_t)] \varepsilon_t$$

Where  $\varepsilon_t$  is the error term, and  $\varepsilon_t \sim \text{i.i.d. } N(0, \sigma^2)$

Variable Conditions  $S_t$  is assumed and governed by the first order Markov chain process with transition probabilities,  $p_{ij}$ , given by

$$P\{S_t = j | S_{t-1} = i\} = p_{ij} \quad \forall \quad i, j = 1, 2$$

In particular,  $p_{11} = P\{S_t = 1 | S_{t-1} = 1\}$  indicates the possibility of starting in a bullish condition and ended up in the same condition and  $p_{22} = P\{S_t = 2 | S_{t-1} = 2\}$  is the probability of a bearish condition considering that previous condition is also bearish. Parameters and the probability are estimated by maximum likelihood.

Furthermore, the identification results of the stock market conditions by using a Markov switching models will estimate the influence of stock market return, interest rate and exchange rate to sectoral stock return either bullish or bearish condition.

*Bullish Condition :*

$$[r_{it}]_{bullish} = \beta_{i,0} + \beta_{i,1} MR_t + \beta_{i,2} IR_t + \beta_{i,3} ER_t + \varepsilon_t$$

$$\varepsilon_t \sim N(0,1)$$

*Bearish Condition :*

$$[r_{it}]_{bearish} = \alpha_{i,0} + \alpha_{i,1} MR_t + \alpha_{i,2} IR_t + \alpha_{i,3} ER_t + \varepsilon_t$$

$$\varepsilon_t \sim N(0,1)$$

Where:

- $r_i$  = Sectoral stocks return
- MR = Stock market return
- IR = Interest rate
- ER = Exchange rates
- Sector 1 = Finance sector
- Sector 2 = Trade and service sector

## Operational Variables

Fully operational variables are as follows:

Tabel. 1  
Variables Operationalization

Variable	Variable Concept	Indicator	Unit
Sectoral stock return (r)	Yields in general of sectoral stock in the Indonesian capital market	$r_i = (\ln SSI_{it} - \ln SSI_{it-1}) * 100$  $SSI_i = \text{sectoral stock index } i$	%



Stock market return (MR)	Yields in general from the investment in the Indonesian capital market	$MR = (\ln IHSg_t - \ln IHSg_{t-1}) * 100$	%
Interest rate (IR)	The interest rate of Bank Indonesia Certificates (SBI) in one month.	$IR = (\ln(SBI_t) - \ln(SBI_{t-1})) * 100$ Proxy increase of Indonesian interest rate for one month	%
Exchange rates (ER)	The exchange rate of rupiah against US dollar	$ER = (\ln(kurs_t) - \ln(kurs_{t-1})) * 100$ Proxy increase in the exchange rate rupiah against the US dollar	%

Data source is taken from Indonesia Stock Exchange (Indonesian Stock Exchange) and Bank Indonesia with the observation period from January 1996 through December 2013.

## RESULT AND DISCUSSION

### Bullish and Bearish Identification

The Identification of bullish and bearish conditions is based Indonesian stock market returns which use the Markov regime switching models. Based on the proposed model, the values of model parameters have been obtained as follows:

Table 2  
The Parameter of Markov Regime Switching Model Indonesian Stock Market Return  
Period of January 1996 - December 2013

Parameter	Coefficient	Error Standard	Z statistic	Probability
$\mu_1$	1,7007	0,5004	3,3987	0,0007
$\mu_2$	-1,7708	2,2046	-0,8032	0,4218
$S_1$	5,7973	0,0632	27,793	0,0000
$S_2$	14,1327	0,1229	21,551	0,0000
$P_{11}$	0,9860	0,7637	5,5710	0,0000
$P_{22}$	0,9437	0,7385	-3,8179	0,0001

Source: Results of data processing

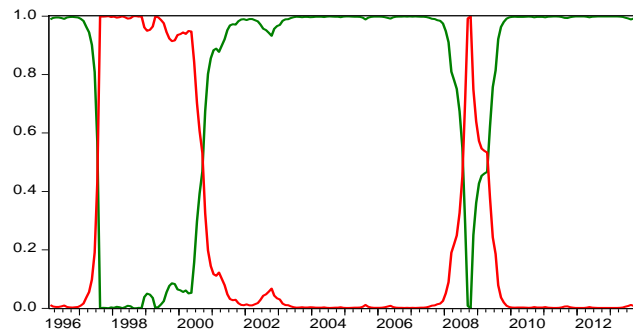
Based on the data results in Table 1, it can be seen that the 6 parameters which are estimated almost significant at the 1 percent level, Only  $\mu_2$  is insignificant either at the 1 percent or 5 percent level. Although there is insignificant from these parameters model, however the interpretation of this model remains attractive. This model shows that we can divide the Indonesian stock market conditions into two regimes. The State 1 showed the average monthly return is positive (1.70% per month or equivalent to 20.40% profit per year). In contrast, the state 2 showed an average negative return month (-1.77% per month, equivalent to 21.24% loss per year).

The standard deviation of state 1 is 5.80%, while the standard deviation of state 2 is 14.13%. It means that means in terms of the state 1 volatility is considered to have a lower volatility than the state 2.

Based on the data results in table 1,  $\mu_1$  value is significant at 1 percent significance level, however,  $\mu_2$  value is not significant. The value of  $S_1$  and  $S_2$  are both significant at the 1 percent significance level. Under these circumstances, we can conclude that the regime switching occurred in the Indonesian stock market is due to the difference in volatility.

Thus, the first regime is characterized by positive returns with low volatility (low risk) and the second regime is characterized by a negative return with high volatility (high risk). The author refers to previous studies such as Turner, et al (1989), Maheu et al. (2000), Ismail et al. (2008), Martin PH. Pangabea (2010), Kole et al. (2012). Then the state 1 was identified as the bullish condition and the state 2 was identified as the bearish conditions.

The results of the estimation using Markov switching models, can be used to divide the historical data observations into bullish and bearish periods as shown in Figure 1. Figure 1 shows the smoothed regime probabilities return IHSg during the period of February 1996 to December 2013.



Gambar 1  
Smoothed Regime Probabilities return IHSG  
— P(S(t)= 1) — P(S(t)= 2)

Source: Results of data processing

Table 3  
Bullish and Bearish period Indonesia Stock Exchange  
February 1996 - December 2013

<i>Bullish Period</i>		<i>Bearish Period</i>	
February 1996 – July 1997	18 months	August 1997 – September 2000	38 months
October 2000 – July 2008	94 months	August 2008 – April 2009	9 months
May 2009 – December 2013	56 months		
78%	168 months	22%	47 months

Source: Results of data processing

Based on figure 1 and table 2, it can be concluded that during the observation period of February 1996 to December 2013 (215 observations), Indonesian stock market experienced a 78 percent (168 observations) bullish conditions and 22 percent (47 observations) bearish conditions.

Tabel  
Descriptive Statistical Study Variables  
Period of February 1996 - December 2013

Parameter	R_Sector1	R_Sector2	MR	IR	ER
<b>Bullish Condition (168 observations)</b>					
Mean	1,97	1,59	1,68	-0,303	0,174
Std Dev.	6,85	6,39	5,72	3,161	2,999
<b>Bearish Condition (47 observations)</b>					
Mean	-3,66	-1,66	-1,76	-0,144	2,933
Std Dev.	15,30	17,80	14,52	14,073	16,886

Mean stock returns sector 1, stock returns sector 2 and stock market returns have an average higher point during the bullish than bearish period. The interest rate experienced an average greater reduction in bullish period. It indicates that the interest rate is relatively lower during the bullish condition. exchange rate rupiah against the US dollar on average experienced a larger increase in the bearish period which indicate more rupiah needed for every dollar that is required. In general, the bearish period shows the variables standard deviation is higher than the bullish period, which means that in the bearish period, all variables have higher volatility.

### Stationarity Test and Normality Data

The stationarity testing data of stock market return, interest rate and exchange rate used the Augmented Dickey Fuller (ADF) and Phillips-Perron test (PP) test. While the data normality testing used the Jarque Bera (JB) test. The test results of stationarity and normality of data are shown in table 2.

Table 4  
The Result of Stationarity and Normality Data  
Stock Market Variables And Macroeconomic

Variable	JB Test		ADF Test		PP Test	
	Jarque-Bera	Prob.	t-stat	Prob	Adj. T-stat	Prob
MR	215,894	0,000	-12,270	0,000	-12,270	0,000
IR	2263,584	0,000	-6,562	0,000	-6.600	0,000
ER	15060,730	0,000	-12.857	0.000	-12.771	0.000

Table 4 shows the ADF test and PP test are significant at the 1 percent level for all variables. It means that the data stock market and macroeconomic variables as a research variable are in a stationary condition. The data test normality shows that the JB test of stock market and macroeconomic variables did not meet the normality conditions. This condition prompted the authors to use robust least square.

Robust Regression analysis provides an alternative to the least squares regression when the underlying assumptions are not fulfilled by the nature of the data (normality assumption). The most common general method of Robust Regression is M-estimation, which was introduced by Huber (1964), which is almost as efficient as OLS (Alma, 2011).

Tabel 5  
Regression results using robust least square

Parameters	Financial Sector	Trade, Service and
Bullish Condition		
$\beta$ MR	***0.992643	***0.937546
$\beta$ IR	-0.120229	-0.033479
$\beta$ ER	-0.134605	0.059655
$R_w^2$	0.8199	0,7377
$R_N^2$ Statistic	***564.8683	***354.8271
Bearish Condition		
$\alpha$ MR	***0.780042	***1.032899
$\alpha$ IR	0.041378	**-.0.144700
$\alpha$ ER	***-0.270355	***-0.413888
$R_w^2$	0.706895	0.906551
$R_N^2$ Statistic	***84.68922	***310.4821

\*\*\*) significant at 1% level\*\*) significant at 5% level

### DISCUSSION

The data processing results using a robust least square method can produce the  $R_w^2$  value, which indicates the goodness of fit. The value of  $R_w^2$  indicates the ability of independent variables in the model to explain the variation of dependent variable. Renaud and Victoria-Feser (2010) proposed the

$R_w^2$  statistics. They provide simulation results that show the  $R_w^2$  become a measure of goodness of fit better. For a simultaneously hypothesis test, the  $R_N^2$  statistics is used which is a robust version for *Walt test*.

The value of  $R_N^2$  statistic for the finance sector and trade and service sector are significant at 1 percent level, both on the bullish and bearish condition of the stock market conditions. This condition indicates a strong rejection from the null hypothesis that all the coefficients of non-intercept are equal to zero, thereby, stock market return, interest rate, and exchange rate, affect together on sectoral stock returns in bullish and bearish condition.

These results are consistent with research done by Mysami et al., 2004; Gan et al., 2006, and Butt et al., 2010, which concluded that the macroeconomic variables and stock market affect the stock price or stock return. These results proved that the Indonesian capital market investors generally consider the stock market variables and macroeconomic in deciding to invest in common stock. In general, the changes in the stock price index, interest rate and exchange rate still become determinants of sectoral stock returns in the Indonesian capital market. Investors still consider the stock market and macroeconomic variables can affect cash flow, discount rate and the investors interest in order to invest the stock in Indonesian capital market.

Based on this research, the stock market return positively affect the stock returns of finance sector and trade and services sector both in bullish and bearish conditions. The results of this study are in line with the theory developed by Sharpe (1964) and Litner (1965), which implies a positive linear relationship between the stock market return or market risk and stock returns. The results of this study also supports the findings of Butt, et al (2010) which have been influenced by positive stock market return to the examined sectoral stocks return.

The positive influence from the stock market return on sectoral stock return either in bullish or bearish condition reflects a favorable investment climate in the stock market, so investors will respond positively to the capital market. Thus, investors will tend to perform buying and selling action of the traded stocks based on stock market index occurred. These results also confirm that the stock market return factor is the main factor in determining the sensitivity of stock returns of finance sector and trade and services sector, in the Indonesian capital market.

Based on this study, the effect of the interest rate varies with the stock return of finance sector and trade and service sector, in bullish and bearish condition. On bullish conditions, the effect of interest rates is not significant to stock return of finance sector and trade and service sector. This result is consistent with the research conducted by Butt et al. (2010) who found that the effect of the risk-free interest rate is not significant in most of the different sector stocks.

This condition can occur due to the bullish conditions of interest rate is 1-month SBI rate is relatively stable. It can be seen from the volatility or standard deviation during the bullish condition is relatively low, and the average growth rate with large negative scores which indicates the level of interest rate is at a low level. With volatility and low interest rates, investors will pay more attention to other risk factors to consider the investment.

While in the bearish conditions, sectoral stock return which is significantly and negatively affected by interest rate is the trade and service sector. The results of this study is in line with findings of Maysami, et al. (2004) on the Singapore stock market, which has found that interest rates have a significant effect on the general stock market index.

The increase of interest rates during the bearish period will be considered to disturb or interfere the income issuers in this sector. Industries, such as retail will be a lot associated with short-term funding needs such as working capital loans and consumer credit. This condition causes the interest rate negatively affect the stocks returns of trade and service sector.

Based on this research, in a bullish market condition, the exchange rates did not significantly influence on the stock return of the finance sector and trade and service sector. This result is in line with the research conducted by Butt, et al (2010) on Pakistan's stock exchanges where it is also found that the exchange rate did not significantly influence on the stock returns from the studied sectors.

Negative and significant impact of exchange rates against the stock return of finance sector and trade and service sector in bearish condition. These results concur with those of Gan et al. (2006) in the New Zealand's stock exchanges which concluded that the effect of the exchange rate to stock return is negative.

While in the bearish period, the negative influence of exchange rates against the stocks return happens due to the stock investors on that sector see the rise in the exchange rate in bearish condition is larger. It could have an impact on price increasing of the imported goods which are used

as raw materials or merchandise. The increasing number of paid foreign loans in dollars, will impact on the level of corporate profits in the future. This condition will be responded negatively by investors that could lead to the decline in stock prices and stock returns in these sectors.

## CONCLUSION

By using Markov switching models, the stock market conditions can be divided into two conditions, namely bullish and bearish conditions. The difference of conditions is due to the difference in market volatility. The stock market return, interest rate and exchange rate are the factors that jointly affect the stock return in finance sector and trade and service sector in Indonesian capital market either in bullish or bearish condition. The stock market return is a main factor in determining the stock return of the financial sector and trade and service sector. In bullish conditions, the Interest rate and the exchange rate against the US dollar is not a significant factor to be taken into consideration by the investors to invest their stocks in finance sector and trade and service sector in the Indonesian capital market. In bearish condition, the interest rate factor becomes the factors that need to be taken into account by the stock investors in trade and service sector, while the exchange rate against the US dollar is a factor that needs to be taken into account by investors who will invest the stocks in the financial sector and trade and service sector..

## REFERENCES

1. Alma, Özlem Gürünlü. 2011. "Comparison of Robust Regression Methods in Linear Regression". Int. J. Contemp. Math. Sciences, Vol. 6, no. 9, 409 – 421.
2. Ang, A. and Bekaert, G. 2002. *International asset allocation with regime shifts*. Review of Financial Studies, 15(4):1137–1187.
3. Bodie, Zvi, Kane, Alex and Marcus, Allan J. 2009. *Investment*, Eighth Edition, New York: McGraw-Hill Companies Inc.
4. Brown, Keith C and Reilly, Frank K. 2009. *Analysis of Investment and Management of Portfolio. Ninth Edition. Canada: South-Western-Cengage Learning*
5. Butt, Babar Zaheer; Rehman, Kashif Ur; M. Khan, Aslam dan Safwan, Nadeem, 2010. *Do economic factors influence stock returns? A firm and industry level analysis*. African Journal of Business Management Vol. 4(5), pp. 583-593
6. Chen, S. N. (1982), *An examination of risk return relationship in bull and bear markets using time varying betas*, Journal of Financial and Quantitative Analysis; 17(2) pp. 265–286.
7. Fama, Eugene F., and French, Kenneth R. 1992. *Filter rules and stock trading strategies*, Journal of Finance 47, 153–175.
8. Gan, C., Lee, M., Yong, H.H.A., & Zhang, J (2006). *Macroeconomic variables and stock market interactions: New Zealand evidence*. Investment Management and Financial Innovation, 3(4), 89-101
9. Guidolin, Massimo, and Allan Timmermann. 2004. *Economic implications of bull and bear regimes in UK stock and bond returns*, Economic Journal 115, 111–143.
10. Hamilton, J. D. 1989. *A new approach to the economic analysis of nonstationary time series and the business cycle*. Econometrica, 57:357–384.
11. Hamilton, James D. and Raul Susmel. 1994. *Autoregressive conditional heteroskedasticity and changes in regime*, Journal of Econometrics 64, 307–333.
12. Hamilton, J. D. and Lin, G. 1996. *Stock market volatility and the business cycle*. Journal of Applied Econometrics, 11:573–593.
13. Ismail, Mohd Tahir and Isa, Zaidi. 2008. *Identifying Regime Shifts in Malaysian Stock Market Returns*. International Research Journal of Finance and Economics ISSN 1450-2887 Issue 15 (2008), pages : 44 – 57.
14. Jones, Charles P. 2007, *Investment Analysis and Management*. Tenth Edition. John Wiley & Son.
15. Khalid, M., Sultana, Mariam and Zaidi, Faheem. 2013. *Dual Beta Modeling of Karachi Stock Exchange*. Mathematical Theory and Modeling, ISSN 2224-5804 (Paper) ISSN 2225-0522 (Online) Vol.3, No.8, 2013
16. Kim, M. K. & Zumwalt, J. K. (1979), *An analysis of risk in bull and bear markets*, Journal of Financial and Quantitative Analysis; 14(5) pp. 1015–1025.
17. Kole, E., J.C. Van Dijk, Dick. 2012. *How to Identify and Predict Bull and Bear Markets?*, Econometric Institute, Erasmus School of Economics, Erasmus University Rotterdam.

18. Lintner, J. 1965. "The Valuation of Risk Assets and The Selection of Risky Investments in stock Portfolio and Capital Budgets". *Review of Economics and Statistic*, 47:1, 13-47.
19. Lunde, A. and Timmermann, A. 2004. *Duration dependence in stock prices: An analysis of bull and bear markets*. *Journal of Business & Economic Statistics*, 22(3):253–273.
20. Maheu, J. M. and McCurdy, T. H. 2000. *Identifying bull and bear markets in stock returns*. *Journal of Business & Economic Statistics*, 18(1):100–112.
21. Maheu, J. M., McCurdy, T. H., and Song, Y. 2012. *Components of bull and bear markets: bull corrections and bear rallies*. *Journal of Business & Economic Statistics*, Volume 30, Issue 3, July 2012, pages 391-403.
22. Maysami, R.C. and Kho, T.S. 2000. *A Vector Error Correction Model of The Singapore stock market*. *International Review of economics and finance*, vol 9: 79-96
23. Maysami, R.C., Howe, L.C., & Hamzah, M.A. (2004). *Relationship between macroeconomic variables and stock market indices: cointegration evidence from stock exchange of Singapore's All-S sector indices*. *Jurnal Pengurusan*, 24, 47-77.
24. Meginson William, L. 1997. *Corporate Finance Theory*, Addison-Weyley Educational Publisher Inc.
25. Panggabean, Martin P.H. 2010. *Is There Bull and Bear Markets in the Indonesia Stock Exchange?*. *Jurnal Akuntansi dan Keuangan*, Vol. 12, No. 1, Mei 2010: 1-8
26. Renaud, Olivier and Victoria-Feser, Maria-Pia. 2010. "A robust coefficient of determination for regression". *Journal of Statistical Planning and Inference* 140 (2010) 1852–1862
27. Schwert, G. W. 1990. *Indexes of u.s. stock prices from 1802 to 1987*. *Journal of Business*, 63(3):399–426.
28. Sharpe, William F, 1964. *Capital Asset Prices: A theory of Market Equilibrium Under Condition of Risk*, *The Journal of Finance*, Vol. 19, Issue 3, 425 – 442
29. Turner, Christopher M., Richard Startz, and Charles R. Nelson. 1989. *A markov model of heteroskedasticity, risk, and learning in the stock market*, *Journal of Financial Economics* 25, 3–22.

## **TIMELINESS MEDIATING EFFECT ON INFLUENCE OF CORPORATE SOCIAL RESPONSIBILITY (CSR) DISCLOSURE AND VOLUNTARY DISCLOSURE TOWARD INFORMATIVENESS OF EARNINGS**

Ratna Wijayanti Daniar Paramita, Kurniawan

STIE Widya Gama Lumajang  
[pradnyataj@gmail.com](mailto:pradnyataj@gmail.com)

### **ABSTRACT**

Informativeness of earnings is one of the methods used to use the earnings as the dependent variable in regressed with stock returns as independent variables. This method measures the magnitude of abnormal returns in response to the expected component of a company's reported earnings by using the Earnings Response Coefficient (ERC) (Scott: 2010: 154). Voluntary disclosure is voluntary disclosure by public companies as additional disclosures predetermined minimum. Voluntary disclosure are included in this category are the additional disclosures related to the company's financial information and the disclosure of corporate social responsibilities (CSR). Both voluntary disclosure is expressed in the form of annual reports (annual report) in the form of a sustainability report (sustainability reporting). While one of the criteria for the adequacy of the supporting information obtained investors is through timely submission of reports (Timeliness) (FASB, 1980). This study examined the direct effect of voluntary disclosure and CSR to the informativeness of earnings proxied with ERC and indirect influence Timeliness as a mediating variable is used SEM AMOS. The test results prove there is influence between voluntary disclosure against informativeness of earnings. The test results are consistent with Adhariani (2005), Widiastuti (2002) and Murwaningsari (2010), but not consistent with the research Eriana (2010) which showed positive results are not significant. There is the influence of Corporate Social Responsibility on the informativeness of earnings. The test results are consistent with Sayekti (2007) and Eriana (2010). Timeliness is a voluntary mediation effect disclosure and Corporate Social Responsibility to the informativeness of earnings.

**Keywords:** *informativeness of earnings, Earnings Response Coefficient (ERC), Voluntary disclosure, Corporate Social Responsibility, Timeliness, earnings persistence.*

## **Introduction**

The information disclosed in the issuer's annual report can be grouped into two, namely the expression compulsory (mandatory disclosure) and voluntary expression (voluntary disclosure). The phrase is the information required to be disclosed by issuers governed by the laws of a country's capital market. While the expression of a voluntary disclosure of information beyond the minimum requirements of the applicable capital market regulations.

Voluntary disclosure or voluntary disclosure is voluntary disclosure by public companies as additional disclosures predetermined minimum. Voluntary disclosure are included in this category are the additional disclosures related to the company's financial information and the disclosure of corporate social responsibilities (CSR). Both voluntary disclosure is expressed in the form of annual reports (annual report) in the form of a sustainability report (sustainability reporting). The Company has the discretion to make voluntary disclosures in the annual report that gave rise to the broad diversity of expressions or variations of voluntary inter-company (Widiasatuti, 2002: 76)

Wolk and Tearney (1980) in Marwata (2000) states disclosure regarding the provision of information required by the competent authorities or voluntarily by the company, in the form of financial statements, information that occur after the date of the financial, management analysis on the future operation of the company, financial predictions and operations in the coming year, and additional financial statements that include the phrase by segment and other information beyond cost. Hendricksen and Breda in Widiastuti (2002: 74) defines a disclosure (disclosure) as providing some of the information needed for optimal operation of efficient capital markets.

Understanding Voluntary Disclosure by Meek et al. (1995) in Gulo (2000) is as follows: "Voluntary Disclosure is the free choice of the management company to provide accounting information and other relevant information for decision-making users of the annual report. Because the company has the flexibility to make voluntary disclosures in the annual report that gave rise to the diversity or variation of inter-company voluntary disclosure. "

Annual reports is a separate report with the financial statements (financial statement). However, submission of annual reports by public companies also will affect investors in providing information in response to reported earnings. Some researchers are trying to test whether there is influence of voluntary disclosure in the annual report of the Earnings Response Coefficient (ERC). Research conducted by Widiastuti (2002) concluded that the voluntary disclosure positive effect on Earnings Response Coefficient (ERC), and this conclusion remains consistent after inserting control variables were considered to affect Earnings Response Coefficient (ERC). However, the results of the sensitivity test using a model of fundamental returns indicate that extensive voluntary expression of a negative influence on Earnings Response Coefficient (ERC), although not significant.

Adhariani (2005) conducted a study of 90 companies manufacturing in the period 1998 to 2000, also concluded that the level of voluntary disclosures positive effect on Earnings Response Coefficient (ERC). This conclusion is consistent after researchers included control variables: the book value per share, Leverage, and audit opinion. The results of the sensitivity test also shows the same conclusion.

Research on the relationship with the voluntary disclosure Earnings Response Coefficient (ERC) gave inconsistent results. Kartajumena (2011) examined the factors affecting the level of disclosure found that companies that have a low correlation of returns and earnings more disclosure, in other words Earnings Response Coefficient (ERC) is negatively related to the broad disclosure.

Research conducted by Nugrahanti (2006) against 47 companies listed on the Stock Exchange until December 31, 2002, again showed similar results, namely the conclusion that the voluntary disclosure positive effect on Earnings Response Coefficient (ERC). Murwaningsari (2008) and Paramita (2013) states that the effect of voluntary disclosure to the Earnings Response Coefficient (ERC) showed findings consistent with several previous studies.

Various definitions of Corporate Social Responsibility or CSR has been widely described. CSR apply a concept whereby companies are committed to contributing to society and the environment, in order to provide benefits to the community and maintain environmental functions. The company does not have to always be concerned with profit and finance, but also has a social responsibility to employees,



society and the environment. CSR is not just a charity, but CSR requires a firm in its decision-making in order to seriously take into account due to all stakeholders (stakeholders) of the company, including the community and the environment.

A broad definition by the World Business Council for Sustainable Development (WBCSD) is a global association of approximately 200 companies that are specifically engaged in the field of "sustainable development" which states as follows: "CSR is an ongoing commitment by businesses to act ethically and contribute to economic development of the local community or society at large, along with an increase in the standard of life of the workforce and the whole family "

Various studies show that the number of companies doing CSR disclosure in the annual report is increasing. Likewise, the amount and type of information disclosed CSR increasing (Ernst & Ernst, 1978; Trotman, 1979; Kelly, 1981; Pang, 1982; Guthrie, 1982; Gray, 1990; Gray et al, 1993; in Sayekti, 2007) . Several studies link between CSR (corporate social performance) with the financial performance of the company (corporate financial performance) did show a positive trend.

Investors should consider the voluntary disclosure and Corporate Social Responsibility (CSR) to be reported in the annual financial statements of the company, resulting in investor decision making is not solely based on profit information only. Voluntary disclosure of financial information and information Corporate Social Responsibility (CSR) will provide additional information other than that included in the accounting profit. The Company will disclose the information if the information would increase the value of the company (Basamalah et al, 2005).

Corporate Social Responsibility (CSR) is the process of communicating the social and environmental impact of economic activity on the organization of special interest groups and on society as a whole (Heckton and Milne, 1996). Disclosure of Corporate Social Responsibility (CSR) through sustainability reporting has become an important and especially when making long-term investment decisions, with reporting performance through Corporate Social Responsibility (CSR) will reflect whether the company has been running the social and environmental accountability optimally or not, which also will be revealed that the company concerned has been implementing best practices, norms of fair business, initiative, consensus and commitment that agree or disagree with the legislation in force. Besides, the company will be open and honest in the delivery of accurate information or reporting on the implementation of the program of Corporate Social Responsibility (CSR) to stakeholdersnya.

CSR practices are carried out in order to be known by its stakeholders, companies must conduct disclosure of its CSR practices. CSR disclosure practices undertaken by the company led to the need to incorporate social elements in corporate responsibility into accounting. This led to the birth of a concept known as Social Accounting, Socio Economic Social Responsibility Accounting or Accounting (Indira and Early, 2005).

Gray et al. (1994) defines *Social and environmental accounting* as: ... the process of communicating the social and environmental effects of Organizations' economic actions to particular interest groups within society and to society at large ...

From the above definition of social accountability accounting is a process of communicating the social and environmental impacts of economic activities of the organization to specific groups of stakeholders and society as a whole. Until now there are differences of opinion about the content of CSR disclosure itself (Chariri and Ghazali, 2007). In a survey conducted by Ernst and Ernst, 1998 (in Chariri and Ghazali, 2007) found that the disclosure be said with regard to social issues (and the environment) if such disclosure contains information that can be categorized into the following groups:

1. Environment
2. Energy
3. Reasonable business practices (fair)
4. Human resources
5. Community involvement
6. The product
7. Other Disclosures

Sayekti (2007) examined the influence of social responsibility disclosure to Earning response Coefficient (ERC) and concluded that social responsibility in the company's annual report negatively affect Earning response Coefficient (ERC). These results indicate investors mengapresiasi social responsibility information disclosed in the annual report of the company.

Kartajumena (2010) investigated the influence of Voluntary disclosure and Corporate Social Responsibility (CSR) to Earning Response Coefficient (ERC) of the manufacturing company and concluded that simultaneous Voluntary disclosure and Corporate Social Responsibility (CSR) to Earning Response Coefficient (ERC) has no effect significant, but partially have different influences, in this case Voluntary disclosure have a negative influence and Corporate Social Responsibility (CSR) has a positive influence on Earning Response Coefficient (ERC)

One of the supporting criteria for adequacy of information obtained by investors is through timely submission of reports (*Timeliness*) (FASB, 1980). Bapepam set decision 80 / PM / 1996 concerning the obligation to submit financial statements prepared under accounting standards of the Indonesian Institute of Accountants namely that a public company shall submit an annual financial report with the opinion accountant who audited not later than 120 days from the date of the end of the fiscal year and shall be announced to the public through at least two daily newspapers in Indonesian language.

Timeliness presentation of financial information is an important element in order to provide benefits to investors in making rational decisions. Some research revealed timeliness phenomenon indicates that the publication of financial statements containing information accounting profit responded differently when published on different levels of timeliness (Atiase, et al., 1989). Sutikno and Sabeni (2000) in his study had findings that the financial statements of companies listed on the Jakarta Stock Exchange has been serving the accounting information reliable but is not relevant and comparable as the basis of decision-making because of the delay time of delivery.

Informativeness of earnings is one of the methods used to use the earnings figures as the dependent variable diregaskan with stock returns as independent variables. This method measures the magnitude of abnormal stock returns in response to the expected component of a company's reported earnings by using the Earnings Response Coefficient (ERC) (Scott: 2010). Informativeness of earnings in this study further proxied by using the Earnings Response Coefficient (ERC) is a method used to measure the level of corporate profits.

## Formulation Of The Problem

Based on the description of the background of the problem and previous research that researchers made the basis for the conduct of research, the formulation of the problem in this study are:

1. Do Voluntary disclosure have significant influence on the informativeness of earnings?
2. Do Corporate Social Responsibility (CSR) have a significant influence on the informativeness of earnings?
3. Do Timeliness is to influence Voluntary mediation disclosure and Corporate Social Responsibility (CSR) to the informativeness of earnings?

## Research Purposes

Based on the background of the problem and the formulation of the problem, the goal of the research is to identify and analyze:

1. Effect of Voluntary disclosure on informativeness of earnings?
2. Influence of Corporate Social Responsibility (CSR) to the informativeness of earnings?
3. imeliness effects as mediation for Voluntary influence disclosure and Corporate Social Responsibility (CSR) to the informativeness of earnings?

## Hypothesis

Based on theoretical studies and empirical evidence on some of the research that has been done before, the hypothesis proposed in this study are:

1. Voluntary disclosure have an influence on the informativeness of earnings.
2. Corporate Social Responsibility (CSR) have an influence on the informativeness of earnings.
3. Timeliness is a mediating variable to influence disclosure Voluntary and Corporate Social Responsibility (CSR) to the informativeness of earnings.

## Research Methods

### Data Collection Techniques

The study population includes all companies listed on the Indonesia Stock Exchange. Sampling using purposive sampling method. In this technique the sample taken is a sample that has certain criteria in order to represent the population. Sampled companies must meet the following criteria:

1. Companies that remain active in operation from 2009 until December 2013, and to publish audited financial statements on a regular basis.
2. The company did not stop its activities in the stock market, do not stop the operation and does not perform as well as the merger does not change the status of the industry sector.
3. The Company did not incur a loss during the estimation period.
4. Complete data are used as variables in this study and is consistently reported in the Securities and Exchange Commission

Of samples above criteria can be known companies that can be sampled in this study were as many as 30 companies during 5 years of observation.

### Operational Variables

Will outline the operational variables operationally variable according to researchers with reference to the conceptual definition and accompanied by indicators of variables including the scale of measurement. In this study can be explained operational definitions in table 1, as follows:

Table 1.  
Operational Variables and Measurement Scale

Variables	The concept of indicator variables	Indicator	Measure ment Scale
<i>Earnings Response Coefficient (ERC)</i>	Regression relationship between reported earnings with stock returns	ERC stock returns obtained from regression between the CAR and the EU Ratio	Ratio
<i>Voluntary disclosures</i>	Quantification of the financial information or social responsibility information contained in the issuer's annual report and indicates the level of disclosure items such information.	According Botosan (1997), Measurement of voluntary disclosure using the index (index disclosures), obtained by: $IDX = \frac{\text{Total score disclosure}}{\text{Maximum score disclosure}}$ Components of the financial information disclosure that should be reported:	Ratio

		1. Background of the company 2. The non-financial information 3. Information future projections company 4. Analysis of management Total score of 140	
<i>Corporate Social Responsibility (CSR).</i>		Corporate Social Responsibility (CSR). The components of the voluntary disclosure refers Sembiring (2005) 1. Environment 2. Energy 3. Health and safety labor 4. Others with teng work 5. Product 6. Involvement with the community 7. General Maximum Score 78	Ratio
<i>Timeliness</i>	Date of reporting to Bapepam	Timeliness is the span of the announcement of financial statements audited annual (audited) to the public, namely the length of days required to announce the annual financial statements are audited to the public, since the company's fiscal year closing date until the date of submission to Bapepam. This variable is denoted by TIME	Ratio
<i>Persistensi laba</i>	<ul style="list-style-type: none"> <li>Profit</li> </ul>	(Kormendi & Lipe, 1987) Regression Slope top $X_{it} = a + bX_{it-1} + E_t$ $X_{it}$ = profit of firm i in period t $X_{it-1}$ = profit of firm i in period t-1 $b$ = Ratio of earnings persistence	Ratio

Source of data: data is processed

Further explanation of the operational definition of each variable is as follows:

### 1. Earnings Response Coefficient (ERC)

This study was the dependent variable is proxied by Earning Response Coefficient (ERC). Calculation of Earnings Response Coefficient (ERC) is done by stages:

1. Calculate the variable Cumulative Abnormal Return (CAR) with the formula:

$$CAR_{i(-5,+5)} = \sum_{t=-5}^{+5} AR_{it} \quad (1)$$

In this case:

$CAR_{i(-5,+5)}$  : cumulative abnormal return for firm i during the observation period of approximately 5 days from the date of publication of the financial statements. (5 days before, the date of publication and 5 days after the date of publication of the financial statements)

$AR_{it}$ : abnormal return for firm i on day t

- a) In this study, abnormal return is calculated using the model of compliance market (market adjusted model). This is according to Jones (1999) in Murwaningsari (2008) which explains that the best estimate of the return securities market return at that time.

Abnormal return is obtained from:

$$AR_{i,t} = R_{i,t} - R_{m,t} \quad (2)$$

In this case:

$CAR_{i,[t1,t2]}$  = cumulative abnormal return for firm i on day t, [t-5, t + 5] is the length of the interval return (accumulation period) of t-5 to t + 5

$AR_{i,t}$  = abnormal return for firm i in period t ke-

$R_{i,t}$  = Return to the company in the period-t

$R_{m,t}$  = return to the market in the period-t

$\varepsilon_{i,t}$  = standard error

To obtain data on abnormal returns, must first seek daily stock returns and market returns daily.

Daily stock returns calculated by the formula:

$$R_{it} = (P_{it}-P_{it-1})/P_{it-1} \quad (3)$$

In this case:

$R_{it}$  = stock returns of firm i on day t

$P_{it}$  = closing price of stock i on day t

$P_{it-1}$  = closing price of stock i on day t-1.

Daily market returns are calculated as follows:

$$R_{m,t} = (IHSG_t - IHSG_{t-1}) / IHSG_{t-1} \quad (4)$$

In this case:

$R_{m,t}$  = daily market returns

$IHSG_t$  = stock price index on day t

$IHSG_{t-1}$  = stock price index on day t-1.

b) *Unexpected Earnings* as exogenous variables are taken into account by the model of a random walk.

*Unexpected Earnings* (UE) is defined as the difference between accounting profit realized by the accounting profit expected by the market. Unexpected Earning (EC) was measured according to the research Kalaapur (1994) in Novianty (2008):

$$UE_{it} = \frac{(EPS_{it} - EPS_{it-1})}{P_{it-1}} \quad (5)$$

In this case:

$UE_{it}$  : unexpected earnings of firm i in period t

$EPS_{it}$  : earnings per share of firm i in period t

$EPS_{it-1}$  : earnings per share of firm i in period t-1 before t

$P_{it-1}$  : previous stock price

c) *Annual Return* is used to reduce measurement error (Chandrarin, 2002 in Novianty 2008).

$$R_{it} = \frac{(P_{it} - P_{it-1})}{P_{it-1}} \quad (6)$$

In this case:

$R_{it}$  is the annual returns of firm i in period t

$P_{it}$  is the closing price of firm i in period t

$P_{it-1}$  is the closing price of firm i in period t-1

2. Earnings Response Coefficient (ERC) will be calculated from the slope  $\alpha_1$  in relations with the EU after controlled CAR Annual Return.

$$CAR_{it} = \alpha_0 + \alpha_1 UE_{it} + \alpha_2 R_{it} + \epsilon_{it} \quad (7)$$

In this case:

$CAR_{it}$  = cumulative abnormal return for firm i during the period of observation + 5 days of publication of financial statements

$UE_{it}$  = unexpected earnings

$R_{it}$  = Annual Return

$\epsilon_{it}$  = error component in the model on firm i in period t.

Value of  $\alpha_1$  for each sample is the value of the ERC, which is different for each company (*Time series models*)

## Data Analysis Techniques

Consistent with the hypothesis and objectives to be achieved in this study, the data will be analyzed by using SEM AMOS. In this research through direct testing and it indirectly on the dependent variable.

### 1. Testing directly between Voluntary disclosure and CSR to Earning Response Coefficient (ERC).

Hypothesis testing using Structural Equation Modeling (SEM) to determine the relationship model variables tested (Singgih, 2011). P-values in this study using a 5% level of significant (alpha 0.05). In the process of testing the hypothesis if  $p > 0.05$  then the test result means there is no real or significant influence between variables in the hypothesis, and vice versa.

### 2. Testing Indirect between Voluntary disclosure and CSR to Earning Response Coefficient (ERC) with Timeliness as a mediating variable

In testing mediation, basic decision is to compare the coefficient indirect influence coefficient direct influence. The coefficient of direct influence of two variables in the table Standardized Direct Effect multiplied to determine the total. Then the results will be compared, if the coefficient indirect effect (Indirect Effect) is greater / equal to than the direct influence coefficient (Direct Effect), then the variables tested the mediating variables, and vice versa.

## RESULTS AND DISCUSSION

### Results of Data Analysis

#### Sample Size

The number of samples in this study were 30 companies manufacturing for years 2009 to 2013 (so  $n = 30 \times 5 = 150$ ). Thus the assumption of large n the desired method of analysis by SEM-AMOS ie  $n > 100$  This research has been fulfilled (Singgih, 2011).

## Structural Equation Modeling

The results of the analysis using SEM full model can be seen in the following figure:

**Figure 1.**  
**Structural Equation Modeling**

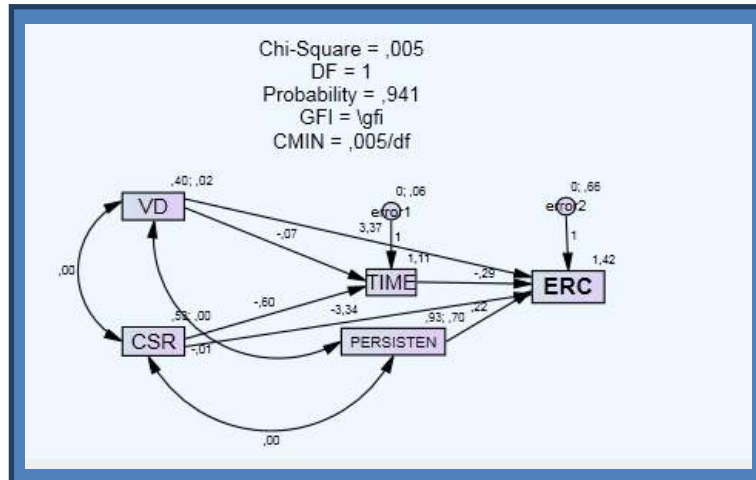


Figure 1. Structural Equation Model: Timeliness mediation effects to influence disclosure and ERC Against Voluntary Earnings Response Coefficient (ERC) with the persistence of earnings as a control variable

Source of data: Data were analyzed with AMOS 21

Based on the *data output text notes for group* shows that the model of recursive form, which means that the model is only one direction and not the model of the *reciprocal* (mutual influence). The number of samples after the *outlier* is 150.

### Model fit test

The next process is to test the suitability of the model look. In this process, obtained Degree of Freedom (df) = 1, if df is positive then the model is over-identified, so that the estimation and assessment of the model can be done.

Suitability test results obtained from the model used in accordance with the model fit test statistic and its cut-off valuenya used in testing whether a model can be accepted or rejected, as presented in Table 2, the following:

table 2  
 Suitability Test Statistics

Goodness of Fit Index	Cut-Off Value	Hasil Model
Chi-Square	$\leq 3,343$ *	0,005
Probabilitas	$\geq 0,05$	0,941
NFI	$\geq 0,9$	1,000
CFI	$\geq 0,9$	1,000
CMIN/DF	$\leq 2$	0,005/df

Source of data: Output Amos 21, processed

\*) The value of Chi\_Square on df = 1 at the significant level of 0.05 (p = 5%)

Based on the test the suitability of the model, then the model has met the criteria and can be fit model analysis process and subsequent testing.

### Normality Test Data

Critical Ratio values are + 2.58 with a significance level of 0:05 (p-value 5%). A data distribution can be considered normal if the value of CR skewnes and kurtosis in the range of -2.58 to table the critical value of 2.58.

Table 3.  
Normality Test Result Data

Variable	min	max	skew	c.r.	kurtosis	c.r.
CSR	,443	,646	,482	2,412	-,588	-1,469
VD	,093	,593	-,657	-3,287	-,218	-,546
PERSISTEN	,017	4,207	1,968	9,840	5,260	13,149
TIME	,230	1,650	-,132	-,660	,086	,214
ERC	,034	2,983	,891	4,457	-,473	-1,183
Multivariate					2,282	1,670

Source of data: Output Amos 21

The test result data indicates cr kurtosis value 1.670 means that the overall or multivariate normal distribution of data because it is in the range of -2.58 to 2.58 so that the normality assumption is met.

### Test Model / Hypothesis Testing

Testing the model is intended to determine how much influence a given VD and CSR to Earning Response Coeffisient (ERC) to answer the hypothesis. Here is the weight Regression output display that shows the correlation between variables, so as to determine whether or not the influence between these variables can be done by testing the hypothesis.

Value estimates and probabilitas generated against structural test of capital as shown in the following table:

Table 4.  
Regression Weight (default model)

#### Regression Weights: (Group number 1 - Default model)

		Estimate	S.E.	C.R.	P	Label
TIME <---	VD	-,073	,164	-,444	,657	par_4
TIME <---	CSR	-,604	,378	-1,596	,111	par_5
ERC <---	CSR	-3,336	1,307	-2,552	,011	par_2
ERC <---	TIME	-,286	,281	-1,020	,308	par_3
ERC <---	VD	3,374	,563	5,993	***	par_6
ERC <---	PERSISTEN	,224	,080	2,799	,005	par_7

data source: Output Amos 21.



Table 5.  
Standardized Regression Weight (default model)

Standardized Regression Weights: (Group number 1 - Default model)

	Estimate
TIME <--- VD	-,039
TIME <--- CSR	-,141
ERC <--- CSR	-,204
ERC <--- TIME	-,075
ERC <--- VD	,476
ERC <--- PERSISTEN	,203

data source: Output Amos 21.

Results formulation of hypotheses to test directly the results are as follows:

Table 6  
Results Hypothesis Formulation Directly

Hipotesis	Direct Path Analysis	Hasil
H <sub>1</sub>	VD → ERC	Signifikan
H <sub>2</sub>	CSR → ERC	Signifikan
Path	PERSISTENSI → ERC	Signifikan

Source of data: data is processed

As for knowing the results of hypothesis formulation relationship it indirectly, look at the text output: standardiedz direct effects, indirect effects and the standardized total effect in the following table:

Table 7.  
Standardidez Direct Effect

Standardized Direct Effects (Group number 1 - Default model)

	CSR	VD	PERSISTEN	TIME
TIME	-,141	-,039	,000	,000
ERC	-,204	,476	,203	-,075

Source of data: Output Amos 21

Table 8.  
Standardidez Indirect Effect

Standardized Indirect Effects (Group number 1 - Default model)

	CSR	VD	PERSISTEN	TIME
TIME	,000	,000	,000	,000
ERC	,011	,003	,000	,000

Source of data: Output Amos 21

Table 9  
Results Formulation of Hypothesis Indirectly

Direct relationship	Relationship Indirect	Value Calculation	results *)	Description
VD → ERC	VD → TIMELINESS TIMELINESS → ERC	(-0,039)(-0,075) = 0,003	0,003	Significant
CSR → ERC	CSR → TIMELINESS TIMELINESS → ERC	(-0,141)(-0,075) = 0,011	0,011	Significant

Source of data: data is processed

\*) From table 8: Standardiedz Indirect Effect

### Discussion/Study

Based on the analysis of hypothesis testing, the study of theory and empirical results, we then can be explained influence disclosure Voluntary and Corporate Social Responsibility (CSR) to the informativeness of earnings.

#### **Study of the results of hypothesis testing 1: There is a significant positive effect between Voluntary disclosure against informativeness of earnings**

The results show there is influence between Voluntary disclosure against informativeness of earnings. This means that the extent of voluntary disclosure, the higher the response of shareholders on corporate earnings. In other words, reported earnings response strength. This reaction reflects the quality of the company reported earnings. While the strength responsive to the information presented is strongly influenced by the extent of voluntary disclosure in the annual report.

The influence of the voluntary relationship disclosure against informativeness of earnings in the study can be interpreted investors have confidence about the expectations of return, which is based on publicly available information. However, these beliefs remain affected by how investors absorb the information received and make revisions. Another possibility, as companies serving the wider voluntary disclosure is a company that has Goodnews, so it will be responded positively by investors.

The results are consistent with Adhariani (2004), Widiastuti (2002), and Murwaningsari (2010) but not in line with Eriana (2010) which states that investors are not quite sure of the voluntary disclosure of management reports so that investors do not use these disclosures to absorb information received and revised, so that investors will use the information as a proxy for expected future earnings earnings.

#### **Study of the results of hypothesis 2: There is a significant positive effect between Corporate Social Responsibility (CSR) to the informativeness of earnings**

The results of the hypothesis testing shows there is influence between Corporate Social Responsibility (CSR) to the informativeness of earnings. This means that investors are using social responsibility disclosure in response to earnings reported by the company. So the strength responsive to the earnings reported by companies affected by the disclosure of corporate social responsibility.

This research is in line with research conducted by Sayekti (2007) and Eriana (2010) which states that social responsibility pengungapan positive effect on the company, especially can raise the image of the company that will indirectly increase sales volume (Eriana, 2010).

#### **Study of the results of hypothesis 3: Timeliness as meiasi variables to influence disclosure Voluntary and Corporate Social Responsibility (CSR) to the informativeness of earnings**

Timeliness of information implies that the information before it loses its ability to influence or make a difference in the decision. Ketidaktepatwaktuan financial reporting is a factor that raises questions for users of financial statements regarding the credibility or the quality of the report (Murwaningsari: 2010).

Timeliness is one of the obstacles to get relevant information. The more extensive disclosure and voluntary disclosure of corporate social tanggungjawab will further increase investor response to the expectations of return if it is supported by the timeliness of financial statement. Effects timeliness as mediation and voluntary disclosure of CSR to the market response indicates that the company should be able to minimize ketidaktepatwaktuan submission of financial statements or annual reports. Ketidaktepatwaktuan in the delivery of financial statements or annual reports can be defined as the interval of the number of days between the date of the financial statements until the date of the auditor's report is signed or interval number of days between the date of the financial statements until the date of receipt of the report was published.

## CLOSING

### Conclusion

Referring to the results of hypothesis testing and the discussion that has been described in the previous chapter, it can be some conclusions as follows:

The test results prove there is influence between *voluntary disclosure* against *informativeness of earnings*. The test results are in line dengna Adhariani (2005), Widiastuti (2002) and Murwaningsari (2010), but not in line with the research Eriana (2010) which showed positive results are not significant.

There is the influence of *Corporate Social Responsibility* on the *informativeness of earnings*. The test results are in line with Sayekti (2007) and Eriana (2010).

Timeliness is a voluntary mediation effect disclosure and Corporate Social Responsibility to the informativeness of earnings.

### Suggestion

Taking into account the results of the analysis and the conclusions that have been dikemukakan above, the above studies should be conducted research on the factors that influence the breadth of disclosure Voluntary disclosure and Corporate Social Responsibility and its implications Earnings Response Coefficient (ERC), also need to be investigated selian mediating effect of audit quality on the influence of or placement of quality auditors as control variables timeliness.

## Reference

- Adhariani. (2004) Tingkat Keluasan Pengungkapan Sukarela Dalam Laporan Tahunan dan Hubungannya Dengan Current Earnings Response Coefficient (ERC)". Jurnal Akuntansi dan Keuangan Indonesia. Vol 2, No.1 : 24-57
- Chairiri, Gozhali. (2007). Teori Akuntansi. Fakultas Ekonomi. Universitas Diponegoro Semarang.
- Departemen Keuangan RI, BAPEPEM. (2006). Keputusan Nomor: KEP-134/BL/2006, tentang kewajiban penyampaian laporan keuangan tahunan bagi emiten atau perusahaan publik.
- Financial Accounting Standards Boards,. (2000) Statement of Financial Accounting Concept Number 2: Qualitatif Characteristics of Accounting Information. Stanford, Conecticut.
- Fitriani. (2001) Signifikasi Perbedaan Tingkat Kelengkapan Pengungkapan Wajib Dan Sukarela Pada Laporan Keuangan Perusahaan Publik Yang Terdaftar Di Bursa Efek Jakarta. Makalah Simposium Nasional Akuntansi IV, Bandung. : Universitas Padjajaran dan Ikatan Akuntan Indonesia pp.133-154.
- Gulo, Y., (2000) Analisis Efek luas Pengungkapan Sukarela Dalam Laporan Tahunan Terhadap Cost of Equiyy Capital Perusahaan. Jurnal Bisnis dan Akuntansi, Vol. 2, No. I, April, 45-62.

- Indira, Dini, (2005) Pengaruh tanggung jawab sosial perusahaan terhadap kinerja keuangan. Jurnal MAKSI Vol. 2, No. 5, Agustus, 227-243.
- Jensen-Meckling. (1976) The Agency Theory Of The Firm : Managerial Behavior, Agency Cost And Ownership Structure Journal of Financial Economics 3 : 305-360
- Kertadjudjuma. Eriana (2010) Pengaruh Voluntary Disclosure of Financial Information dan CSR Disclosure terhadap Earning Response Coefficient. 2010.
- Manwata. (2000) Hubungan antara Karakteristik Perusahaan dan Kualitas Ungkapan Sukarela Dalam Laporan tahunan Perusahaan di Indonesia. Tesis S2, Universitas Gadjah Mada Yogyakarta.
- Mulyani, Sri., Nur F.Asik, dan Andayani,. (2007) Faktor-faktor yang mempengaruhi Earnings Response Coefficient (ERC) pada perusahaan yang terdaftar di BEI. JAAI vol.1, no.1 hal:35-45
- Murwaningsari, Ety. (2008) Beberapa faktor yang mempengaruhi Earnings Response Coefficient (ERC). Simposium Nasional Akuntansi (SNA) ke XI, Pontianak.
- Nugrahanti, Yeterina Widi. (2006) Hubungan Antara Luas Ungkapan Sukarela Dalam Laporan Tahunan Dengan Earnings Response Coefficient Dan Volume Perdagangan Pada Saat Pengumuman Laba. Jurnal Ekonomi dan Bisnis Vol XII No.2 : 152-171.
- Paramita, Ratna. (2013) Pengaruh leverage dan size terhadap Earnings Response Coefficient dengan voluntary disclosure sebagai variabel intervening. Jurnal Manajemen dan Akuntansi: 1-15.
- Sayekti, Yosefa, dan Wondabio L. Sensi. (2007) Pengaruh CSR disclosure terhadap Earnings Response Coefficient. Simposium Nasional IX.
- Scott, William R., (2010) Financial Accounting Theory. Second edition. Canada: PrenticeHall.
- Sembiring. Edi Rismanda (2005). Karakteristik perusahaan dan pengungkapan tanggungjawab social. Studi pada perusahaan manufaktur yang tercatat pada Bursa Efek Jakarta. Simposium national VIII. Solo.
- Susilowati, Christine,. (2008) Faktor-faktor penentu ERC. Jurnal Ilmiah akuntansi Vol.7, November 2008 hlm 146-161.
- Widiastuti, Harjanti,. (2002) Pengaruh Luas Ungkapan Sukarela Terhadap Reaksi Investor. Simposium Nasional Akuntansi VI: 1314-1326.
- \_\_\_\_\_ (2002) Pengaruh Luas Ungkapan Sukarela Dalam Laporan Tahunan Terhadap Earnings Response Coefficient (ERC). SNA 5, Surabaya. hlm 74-86.

# IMPACT OF SOCIAL MEDIA BRAND TO TRUST, BRAND AFFECTION, BRAND LOYALTY (AN CULTIVATION THEORIES APPROACH)

Mahjudin, Dody Suherman, Sumarno

[mahjudin@gmail.com](mailto:mahjudin@gmail.com) , 081330225858  
[dody.suhermawan@gmail.com](mailto:dody.suhermawan@gmail.com) , 08123470500  
[sumarnosby@gmail.com](mailto:sumarnosby@gmail.com), 082133260104

## Abstract

The emergence of Facebook was founded in 2004 and now has about 800 million active users currently the dominant social media used by individuals to communicate with their social group as it also Twitter, other social media tools are widely used to share information and links between individuals, was founded in 2006 and now has about 300 million users is a phenomenon of the emergence of new media that can menjadio means branding activities by companies and marketers. Based on these conditions, this paper will try to test one particular theory, the theory of cultivation, as a conceptual framework in order to better understand the relationship between social media usage and impacts resulting from advertising activities. In the end the results of this paper will allow to provide an understanding of how to use social media effectively to communicate the message and where further research could be done to better understand the newer media.

**Keyword ;** *Brand Equity, Brand Strategy, Online Buying, Social Media Exposure*

## Background of Studies

With the emergence of the Internet in 1990, many advertisers are becoming interested in the possibility of using online media proficiency level for advertising (Berthon, Pitt, & Watson, 1996). Over the years, the supplemental features of Internet services has added that increase its potential as an advertising tool, including social media (Kaplan & Haenlein, 2010). For example, Facebook was founded in 2004 and now has about 800 million active users (Facebook, 2011), is a very dominant social media used to communicate with friends, family, and coworkers, Twitter, other social media tools a lot used to share information and links between individuals, was founded in 2006 and now has about 300 million users (Twitter, 2011). And other social media tools have shown substantial growth since its foundation and, as a result, manarik interest in the advertising industry and business entities that realize the potential of this medium to assist in marketing (Mashable, 2011).

Nielsen news sources, a research institute that is concerned with the audit of social media users, in a release menyebutkan that those who follow brands that appear on Twitter tend to be more prone to buy and recommend products these brands (Swallow, 2011) . This and a number of other short article shows the relationship between the use of social media and interaction with the brand; but still little theoretical support for the study and also considerable research that proves the existence of the relationship statistically.

Based on these conditions, this paper will try to test one particular theory, the theory of cultivation, as a conceptual framework in order to better understand the relationship between social media usage and impacts resulting from advertising activities (Gerbner 1998). In particular, some of the effects of cultivation that may be of interest to companies, marketers, and advertisers are brand trust, brand loyalty and brand affection. Departing from this article seeks to examine whether social media has kontribusi the formation of the advertising impacts which this paper concentrates itself on social media that have strong characteristics to build a relationship (as an essential component of affection brand, brand trust and brand loyalty).

## Theoretical Overview

One important component to determine for the purpose of this research is social media, including how various social media outlets are classified, and the factors that affect the classification. First, "Social media is a group of Internet-based applications are built on a

foundation of ideology and technology of Web 2.0, and that allow the creation and exchange of User Generated Content" (Kaplan & Haenlein, 2010, p. 61). Additionally, social media has been defined broadly as social media interaction (Agichtein, et al., 2008). Even today also have incorporated social media content-content such as blogs, web forums, photo and video sharing communities, and social networking platforms such as Facebook (Agichtein, et al., 2008).

Social media sites have been launched since 1997 with the launch of SixDegrees.com (Ellison, 2008). Over time, more and more social media sites have become prevalent with the big wave of social media in 2000 (Ellison, 2008). Ellison (2008) states, "Since its introduction, social networking sites (SNSs) such as MySpace, Facebook, Cyworld, and Bebo have attracted millions of users, many of whom have integrated these sites into their daily practice" (p. 210).

Given the shift of individuals to use social media every day, more studies have been conducted to investigate the social media and what it means for advertisers and companies, such as research conducted by Mangold and Faulds (2009). In a study by Mangold and Faulds (2009), he argues that social media allows for an individual to communicate with many people about the product and company. Consequently, he argues that social media should be used in integrated marketing communications company (Mangold & Faulds, 2009).

However, not all social media are considered equal. Each different social media outlets offering different features and components for users who support a variety of flowers and practice (Ellison, 2008) individuals. As a result, the classification system put in place to distinguish a social media outlet from the others based on two social media components outlined by Kaplan and Haenlein (2010). Components related media component, which draws from the concept of social presence and media richness, and social components related, which draws from the concept of self-presentation and self-disclosure (Kaplan and Haenlein, 2010). For a better understanding of how different social media outlets function and classified, it is important to first understand the media-related component and then related social component.

There are two dimensions related media used to classify a social media, namely: the presence of elements of wealth and social media. Social presence theory basically states that the different media at the level of social presence (Short, Williams, & Christie, 1976). The presence of widespread social contact auditory, visual, and physical communication is allowed between partners (Short, Williams, & Christie, 1976). Most importantly, the higher the social presence, the greater the impact of communication on the behavior of others (Short, Williams, & Christie, 1976).

Dimensions of the second medium is used to classify social media is media richness theory basically states that the different media based on the level of media richness (Daft & Lengel, 1986). Media richness is seen as the amount of information that is allowed to be transmitted through the medium at a certain time (Kaplan and Haenlein, 2010). The assumption is that one purpose of the communication is to reduce ambiguity, where different points of view, uncertainty, lack of information, which makes it even more rich media, the greater the reduction (Daft & Lengel, 1986).

Basically, some media are more effective than others in reducing ambiguity and uncertainty and provide better information (Daft & Lengel, 1986).

With components related media social media, the results can be highly variable in which social media is able to integrate different communication tools and new information (Ellison, 2008). For example, a variety of social media can use photo postings, mobile connectivity, or a video sharing; However, other sites may be largely text-based (Ellison, 2008). Each of these features change depending on how people use the site, present themselves, and disclose information, so as that the components that exist in social media (Kaplan & Haenlein, 2010).

In addition to the components related media (media related component), there is also a social component related (social related component), which also has two dimensions: self-presentation and self-disclosure. The concept of self-presentation basically states that the social interaction of people have the desire to control the response of others above himself (Kaplan & Haenlein, 2010). Presentation yourself going to help create an image that is consistent with the person's identity (Kaplan & Haenlein, 2010). If this is associated with social media, the reason for someone to join a social network could be to present himself on the internet. Then, the presentation of self occurs through self-disclosure, in which self-disclosure is the act of disclose certain personal information to others (Joinson, 2001).

Therefore, disclosure of self-help develop good relationships with close family, friends, or strangers (Joinson, 2001).

Considering each of the above elements: social presence, media richness, self-presentation and self-disclosure, social media are further classified by the respective segment. Blogs, social networking sites (like Facebook), and virtual social world (like Second Life) all have the look of the presentation of self and a higher self-disclosure with social presence and media richness increasing (Kaplan & Haenlein, 2010). On the other hand, collaborative projects (such as Wikipedia), content communities (such as YouTube), and the virtual game world (like World of Warcraft) has the look of self-presentation and self-disclosure lower the social presence and media richness increased (Kaplan & Haenlein, 2010).

Overall, each of the different outlets provide different benefits for users and producers of content, and becomes important when defining social media will be used in this study. In addition, there is no research that supports social media to put in integrated marketing.

### **Brand Loyalty, Brand Affection, Brand Trust**

There are many ways to define brand loyalty, so it is important to clarify for the purposes of this study. Jacoby and Kyner (1973) states,

"The definition of brand loyalty is expressed in a set of necessary conditions and collectively support. So the brand loyalty is 1) behavioral responses (misall purchase), 2) the bias (nonrandom), 3) declared from time to time, 4) by decision makers, 5) on one brand over another brand, and 6) is function of the decision-making process. "

Each of the above conditions must be met in order to brand loyalty can be developed, and it is also important to note that brand loyalty is a deliberate decision and not an event that happened to occur.

Moreover, the general definition of brand loyalty generally emphasize two key aspects, namely loyalty behaviors and attitudes (Chaudhuri & Holbrook, 2001). Loyalty behavior is also known as the purchasing loyalty and repeat purchases brand consists of Chaudhuri & Holbrook, 2001). Attitudinal loyalty includes elements based on some disposition commitment to the brand because of the unique value associated with the brand (Chaudhuri & Holbrook, 2001).

Finally, there are several factors that influence when it comes to increase brand loyalty that brand affection and trust the brand, which needs to be defined in this paper. Affection brand is basically a consumer response to negative or positive on a brand (Matzler, Grabner-Krauter, & Bidmon, 2008). Affection brand further described as described as the ability to generate an emotional response in the individual as a result of the use of the brand (Matzler, Grabner-Krauter, & Bidmon, 2008). Brand can make people feel a certain emotion that produces feelings on a brand (Matzler, Grabner-Krauter, & Bidmon, 2008).

On the other hand, trust the brand is "confidence in the reliability of the brand to a situation where consumers are at risk of turning" (Delgado-Ballester, Munuera-Aleman, & Yagie-Guillent, 2003, p. 37). Trust the brand is how consumers are willing to rely on the ability of brands to work. Brand trust helps reduce consumer uncertainty because it allows them to rely on a certain level of expected performance (Delgado-Ballester, Munuera-Aleman, & Yagie-Guillent, 2003). Overall, the greater the brand affection and trust the brand, the greater the potential for loyalty (Chaudhuri & Holbrook, 2001).

### **Cultivation Theory**

The purpose of this study is to describe a relationship between the use of social media and brand affection, trust, and loyalty through cultivation theory, and thus, it is important to understand the theory of cultivation and the main factor. Cultivation theory developed in 1969 by George Gerbner, and since then, the effects of television on individual has been studied for decades (Potter, 1993). Cultivation theory in its initial form is basically a communication theory implies that repeated exposure to television, from time to time, will change the viewer's perception of reality (Gerbner, 1998). Gerbner et al. (1980) stated, "We found that the amount of television exposure is an important indicator of the strength of its contribution to the thinking and action" (p. 14).

Cultivation theory developed from the Cultural Indicators project in 1967 conducted by George Gerbner (Potter, 1993). From the Cultural Indicators Project, concluded that television is the medium that can be used by people to socialize into the role and behavior (Gerbner, 1976).

One of the key principles behind the cultivation theory is repeated exposure. The theory holds that the more someone spends time in front of the television, the more likely individuals feel they have a social reality that is congruent with the social reality that seen on television (Gerbner, Gross, Morgan, & Signorielli, 1980). More specifically, "cultivation theory related to the aggregate effect " large, long-term and healthy exposure to a large and heterogeneous community centrally produced, distributed mass, and repeated stories system " (Williams, 2006, p. 74).

In addition, it is also worth noting that the media's ability to attract someone's perception by increasing the amount of exposure through its contents, as well as variations terpaannya will affect the strength of the effect of cultivation (Williams, 2006). Basically, if the content (media content) is more limited, cultivation theory states that the effect of cultivation (cultivation) will run sequentially, therefore if the content (media content) is more limited than the more general media content will play a greater role in shaping perception (Williams, 2006). Another idea that emerged from these theories is their behavior "meanstreaming" (Gerbner, 1998).

"Meanstreaming" is a comparative view of the consistency that began to develop because of exposure to social media content that is very intense and for a long time (Gerbner, 1998). This shows that a very intense exposure can replace the variation information that would normally be acquired and evolved from other factors (Gerbner, 1998). Exposure to recurrent features an A major factor occurrence of cultivation (cultivation). With repeated exposure, which is consistently and continuously, it is expected there will be a general pattern that can grow along with the perception of a stable and wide to the reality (Gerbner, 1998). With intense and consistent exposure to media messages that, individuals begin to align their view of reality where they get the exposure or exposure, and this is where mainstreaming occurs (Gerbner, 1998).

Finally, the last key to understanding the cultivation is to understand the relationships underlying the effects of cultivation and media coverage. The relationship between media and cultivation rather complicated because of the "pull" on the viewers' perception depends on where viewers' lifestyles associated with the "norm" of the world media (Gerbner, 1998). Cultivation is not another word for effect or is regarded as one of the ways; otherwise, the cultivation is seen as a subtle yet complex intermingling the assumption that the influence of the media and the public interact in a dynamic process (Gerbner, 1998). Basically, viewers fuse them with the reality of "social reality" visible in the media and then begin to align their own perceptions.

To test whether the cultivation occurs, the theory see if the "cultivation differential" was developed. "The" differential cultivation "is" conception of reality margin difference between light and heavy viewers in the same demographic subgroups "(Gerbner, 1998, p. 180). If the heavy exposure to make a difference in the perception of reality, the cultivation has occurred.

## **HYPOTHESIS**

Based on the above theoretical studies, it examines the ability of cultivation (cultivation) of social media, which is a new non-traditional media, and its cultivation effects on affective brand, brand trust and brand loyalty. This paper will try to show how social media can make preferences through exposure to a consistent message of the brand in social media. This study will seek cultivation relationship between social media exposure with affection brand, influence, trust, and loyalty. Thus, the hypothesis can be put forward are as follows :

H1: Social Media has a significant impact on brand affection

H2: Social Media has a significant impact on brand trust.

H3: Social Media has a significant impact on brand loyalty.

## **Research Methods**

For the purposes of this study, which examined social media is social media that have high levels of usage for individual social presentation when developing a relationship with another individual (Kaplan and Haenlein, 2010), as well as showing that brand loyalty is essentially a relationship between the brand and consumers, as mentioned above. Social media that meet the criteria are Twitter and Facebook social network that will be the object of research. Blogs and social networking scores low to moderate levels of social presence and media richness scale (Kaplan and Haenlein, 2010), which allows a moderate degree of uncertainty that the



brand and the public may be able to fill up and the opportunity to communicate without too deep, as mentioned above. In addition, content on this site may be narrow and allow more mainstreaming happen.

Data was collected using an electronic survey provided through two social media sites above, Facebook and Twitter, by using a convenience sampling technique. Convenience sampling technique is used because of limited funding for this research and also for the ability to directly recruit people who use Facebook and Twitter to survey administration through the site. A total of 200 people responded to the survey with 93 users of Facebook and Twitter, become a Facebook user only 87, 17, became a Twitter user only, and 3 are not good to use social media (these categories are not mutually exclusive). Then, the participants were asked whether they follow retail brands through social media sites; 40 people reported that they did through Facebook and Twitter, 70 people are doing through Facebook alone, and 14 people are doing via Twitter alone. This study focuses on the people who declare themselves as Facebook user who follows the retail brand. The sample size was 110.

## **Sample**

The data reported below are from samples of 110 Facebook users who follow retail brands through social media. Nearly 60 percent of Facebook users are women and the average age in the sample was 30 years (range = 19-67, SD = 8.7). In addition, 85 percent of the sample reported using Internet social media every day. Television and other Internet website is second two most common sources of media that are used everyday. Of the type of retail brands followed, fashion goods (ie clothes and cosmetics) are the most common with 54 people stating that they follow the type of product; 36 people stated that they follow food products and 20 reported that they follow hard goods (ie equipment and electronics).

## **Data Analysis**

First, the question of the criteria applied to see whether someone is actually using social media are the focus for this research by providing the question "Do you use Facebook?" and "Do you use Twitter?" (Yes or no). Furthermore, given the questions related to the level of use of social media is "On average, how much time a day do you use to access Facebook?" Response choices ranged from 0.25 hours for 9+ hours. Facebook users reported spending an average of 2.68 hours on Facebook (SD = 2.20). Time spent using twitter it was also measured. Both items are summed to create a composite variable used social media. Respondents were also asked to use social media more common question, "How often do you use the following media - Social Media Internet ?." Response options ranged from never (1) to every day (6). The reported average was 5.75 (SD = 0.65), with the majority reporting daily use, which results suggest the use of online media in general to respondents research.

These questions are then followed up with a set of statements that set out to measure the brand influence, trust, and loyalty. This is an item Likert scale (1 = strongly disagree and 7 = strongly agree). Respondents were asked, "Now, think of retail brands you follow on Facebook. Consider the brand and shows the level of agree or disagree with the following statement." The report, which is drawn from the scale by Chaudhuri and Holbrook (2001), is as follows, with each each dimension (trust, influence and loyalty) are listed separately.

Brand affection measured with a two-item index with the following two statements: "I feel good when I use this brand" and coefficient alpha for this two-item index is 0.92 affection brand "This brand makes me happy.". Brand trust is measured by the three-item index with the following three statements: "I believe this brand," "I see this as a brand dishonest," and "I feel brand is not safe". Coefficient alpha for this index of three items brand trust is 0.74. Finally, brand loyalty is measured as an index of two-item with the following two statements: "I would buy this brand next time I buy the kind of products" and "I am committed to this brand." For brand loyalty, the first statement and statement of purchase loyalty measured both measured attitudinal loyalty, as both are brand loyalty needs to happen. Coefficient alpha for these two items brand loyalty index was 0.87.

## **Hypothesis Testing**

All analyzes were performed using the statistical package SPSS version 20. In addition to descriptive statistics are presented as represented above, the correlation dighunakan to examine the relationship between variables the use of social media in general, the use of social media as a composite, a composite index of how people spend time on Facebook and

Twitter, and brand trust, affection brand, and brand loyalty. Regression was also used to look at the impact of brand affection, trust, and loyalty to the various demographic groups such as: age, sex, use of social media in general, the classification of retail brands, and composite social media. Alpha level of 0.005 was used for all statistical tests.

Correlation Test for Facebook users who follow retail brands do to see the relationship between the use of social media in general, the use of social media in the composite, and the level of brand trust, affection, and loyalty to the study respondents. The findings showed a significant relationship is; First, in general, the use of social media correlates significantly with brand trust,  $r(110) = .26, p < .05$ . The use of social media in general also correlated significantly with brand loyalty,  $r(110) = .18, p < .05$ . Finally, the use of social media and brand trust composites were significantly correlated,  $r(110) = -.342, p < .05$ .

Furthermore, three regression models are run to test the hypothesis. Regression was used because it allows the simultaneous analysis of the correlation of several independent variables (age, sex, use of social media in general, the classification of retail brands, and social media in the composite) on the dependent variable (affective brand, brand trust and brand loyalty). By using this kind of analysis will provide a better picture of how the variables are more than one influence and interact with the dependent variable.

The first regression was performed to see the effect on brand affection to the variables of age, sex, use of social media, the classification of retail brands, and composite social media. This model significantly in the form of the relationship with the adjusted R 0.08 In the regression equation between age ( $\beta = .23, p < .05$ ) as a significant variable, gender ( $\beta = .19, p > .05$ ), the use of social media composite ( $\beta = -.04, p > .05$ ), the use of social media ( $\beta = 0.12, p > .05$ ), and the classification of retail brands ( $\beta = .10, p > .05$ ) were not significant predictors. Thus, H1 is not acceptable.

The second regression was done to see the impact on brand trust by the variables of age, sex, use of social media, the classification of retail brands, and composite social media. Adjusted R value at 0.23 shows the model significantly. Sex ( $\beta = .19, p > .05$ ), composites using social media ( $\beta = -.04, p > .05$ ), general use of social media ( $\beta = 0.12, p > .05$ ), and the classification brand retail ( $\beta = .10, p > .05$ ) were not significant predictors. Thus, H1 is not supported.

The second regression is run to see the impact on brand trust by these variables: age, sex, general use of social media, the classification of retail brands, and composite social media. This model is significant in accounting for the variation in brand trust with adjusted R at 0.23. In the regression equations generated significant variables of brand trust: composite using social media ( $\beta = -.37, p < .05$ ), the use of social media in general ( $\beta = 0.28, p < .05$ ), and classification of retail brands ( $\beta = .19, p < .05$ ). Age ( $\beta = .10, p > .05$ ) and Sex ( $\beta = .10, p > .05$ ) were not significant predictors. Consistent with the second hypothesis, the use of social media in the composite was significantly correlated with brand trust (H2;  $\beta = -.37, t(110) = -4.116, p < .05$ ) with H2 thus been accepted.

Finally, the last regression dilakukan to see the impact on brand loyalty by these variables: age, sex, use of social media in general, the classification of retail brands, and the use of social media kompsit. This model significantly by adjusted R = 0.06. When used as the dependent variable of brand loyalty obtained the result that age ( $\beta = .19, p < .05$ ), a significant predictor, but sex ( $\beta = 0.15, p > .05$ ), the use of social media as a composite ( $\beta = -.08, p > .05$ ), the use of social media in general ( $\beta = .16, p > .05$ ), and the classification of retail brands ( $\beta = 0.06, p > .05$ ) did not have a significant correlation with thus, H3 is not proven.

## **FINDINGS**

This study attempted to apply the cultivation theory of social media use specifically focused on two outlets, Facebook and Twitter, and the effect of cultivation on brand affection, trust, and loyalty. The findings presented here are based on several approaches. First, this study looked at the impact of cultivation from a branding perspective and applying theory to social media. Thus, social media is recognized as a potential tool for the cultivation of brand perception, khususnya brand trust.

At the time of the correlation analysis, the correlation was seen between the use of social media in the composite and trust the brand. In addition, there are also korelas between the use of social media in general and brand trust and loyalty. With these results, there are opportunities for future research into what influences and creates the relationship.

Secondly, as seen through regression analysis, the study showed that age could be a contributing factor to the brand influence and loyalty, which allow for further research to be done in what is creating this effect. In addition, this study supports the suggestion that the time spent using social media (composite using social media) associated significantly with brand trust as seen through regression analysis. This study accounted for most of the variance in brand trust as a result of the composite using social media; However, the relationship is visible is a negative relationship.

There are many ways to explain and interpret the possibility of negative the relationship between brand trust and composite use of social media. First, with social media, there is the possibility that the negative and positive comments were made about the brand given that social media allows for two-way communication, as mentioned above. In addition, if someone is exposed to more messages through a higher level of usage of social media, they also may be exposed to more negative comments, in which people who use social media less can only see the brand positive comments. Finally, people interact in social media may be more prone to seek or express negative comments about the brand. This study does not take into account the reasons behind the effects, but more research can be done to better understand the negative impact of composites using social media to brand trust.

In conclusion, similar to the previous cultivation research, this study found no effect of small farming for social media when it comes to trust the brand. That said, this research moves beyond the traditional cultivation media, television, social media. This study also moves beyond the traditional cultivation studies violence, gender roles, and materialism as stated above. Although this study does have some limitations, as shown below, presents the rationale for further investigation into the social media and the effect of potential cultivation as well as social media and its relationship with branding.

### **Limitation**

There are several limitations to this study. First, the sample size is rather small for both Facebook users who follow retail brands, with 110 being the size of the final sample. As a result, the strength of these findings is limited. In addition, because of the convenience sampling technique is used, there is a limited ability to make generalizations about the entire population. In addition, the brand returns to scale are used only two or three items, and therefore may not completely capture the desired effect.

In addition, like most surveys, there is always a chance for self-reporting bias. There is no guarantee that the reporting rate of correct use of social media. Additionally, a large restriction cultivation theory tends to how the level of defined media (Potter, 1993). As in most other aquaculture studies, there is the potential to level the use of different media make studies varied.

In addition, there are specialty retail brands selected for this study. With that in mind, it is likely that a variety of brand better or worse to produce a consistent message that will allow for heavy and mainstream exposure occurs. If a brand does not produce enough content to allow a more severe level of exposure, the cultivation can not happen.

Finally, the correlation indicates that there was no significant association between the use of social media and brand influence and loyalty. The correlation also shows that the relationship between the use of social media and negative brand trust. As a result, there is the possibility that the level heavier than the use of social media has the opposite effect on brand affection, trust, and loyalty. With that in mind, further research can be done to further investigate the potential effects.

### **Conclusion**

Overall, the media landscape has changed rapidly in recent decades with the internet and the shift in the use of social media (Kaplan & Haenlein, 2010). Given that and the nature of social media, there is the potential for centrally produced, mass-distributed, and repeated messages to be sent to the individual, which allows for the cultivation of perception occurs. As a result, social media has the potential to be a good communication tool for marketers and advertisers; However, little research has been done to see what useful outlet and in what way they are useful.

This study tried to see if cultivation occurs in a particular social media, which has a strong characteristic to build relationships. Kultivasi effects studied were brand affection, trust, and loyalty. This study tested for the level of use of the media and trying to find differences in the

effects of cultivation; However, the results showed that social media can have an effect on the cultivation of brand trust. With that there is a stronger association between the use of social media and brand trust, there is room for further research by the theorists of communication to see why and how the relationship occurs. In addition, there is still potential for other studies into the effects of social media and other cultivation.

Overall, given the changes in the use of media and social media is likely to be a good cultivation media, research seems more feasible to investigate. It is suggested that future studies look to develop the relationship between social media and cultivation theory. In addition, for purposes of this study, it is suggested that the study was repeated with a larger sample size and more certain retail brands to strengthen these findings and see if there is an opportunity for the relationship between the use of social media and brand influence and loyalty.

## References

- Brown, J. (2002). Mass Media Influences on Sexuality. *The Journal of Sex Research*, 39(1), 42-45. Retrieved from EBSCOhost.
- Bryant, J. & Zillmann, D. (2008). *Media Effects: Advances in Theory and Research*. NJ: L. Erlbaum. Retrieved from EBSCOhost.
- Chaudhuri, A. & Holbrook, M. B. (2001). The Chain of Effects from Brand Trust and Brand Affect to Brand Performance: The Role of Brand Loyalty. *The Journal of Marketing*, 65(2), 81-93. American Marketing Association. Available from <http://www.jstor.org/stable/3203382>
- Daft, R. L. & Lengel, R. H. (1986). Organizational Information Requirements, Media Richness and Structural Design. *Management Science*, 32(5), 554-571. Available from <http://www.jstor.org/stable/2631846>.
- Delgado-Ballester, E., Munuera-Aleman, J. L., & Yagüe-Guillén, M. J. (2003). Development and validation of a brand trust scale. *International Journal of Market Research*, 45, 35-53. Retrieved from EBSCOhost.
- Ellison, N. (2008). Social Network Sites: Definition, History, and Scholarship. *Journal of Computer-Mediated Communication*, 13, 210-230. doi:10.1111/j.1083-6101.2007.00393.x
- Facebook (2011). Factsheet. Retrieved from Facebook: <http://www.facebook.com/press/info.php?factsheet>
- Gerbner, G. (1998). Cultivation Analysis: An Overview. *Mass Communication & Society*, 1(3/4), 175-194. Retrieved from EBSCOhost.
- Gerbner, G., & Gross, L. (1976). Living With Television: The Violence Profile. *Journal of Communication*, 26(2), 172-200. Retrieved from EBSCOhost
- Gerbner, G., Gross, L., Morgan, M. & Signorielli, N. (1980). The "Mainstreaming" of America: Violence Profile No. 11. *Journal of Communication*, 30,10–29. doi: 10.1111/j.1460-2466.1980.tb01987.x
- Jacoby, J. & Kyner, D. B. (1973). Brand Loyalty vs. Repeat Purchase. *Journal of Marketing Research*, 10(1), 1-9. American Marketing Association. Available from <http://www.jstor.org/stable/3149402>
- Joinson, A. N. (2001). Self-disclosure in computer-mediated communication: The role of self-awareness and visual anonymity. *European Journal of Social Psychology*, 31, 177-192. Retrieved from EBSCOhost.
- Kaplan, A. M. & Haenlein, M. (2010). Users of the world, unite! The challenges and opportunities of Social Media. *Business Horizons*, 53, 59-68 doi:10.1016/j.bushor.2009.09.003
- Mangold, W. G. & Faulds, D. J. (2009). Social media: The new hybrid element of the promotion mix. *Business Horizons*, 52, 357–365. doi:10.1016/j.bushor.2009.03.002
- Mashable (2011). About. Retrieved from Mashable: <http://mashable.com/about/>
- Matzler, K., Grabner-Krauter, S., & Bidmon, S. (2008). Risk aversion and brand loyalty: the mediating role of brand trust and brand affect. *Journal of Product & Brand Management*, 17(3), 154–162. doi: 10.1108/10610420810875070
- Swallow, E. (2011). Following Brands on Twitter Increases Purchase Intent [STUDY]. Retrieved from Mashable: <http://mashable.com/2011/10/20/twitter-brands-purchase-intent/>
- Twitter (2011). What is Twitter. Retrieved from Twitter: <http://business.twitter.com/basics/what-is-twitter/>
- Williams, D. (2006). Virtual Cultivation: Online Worlds, Offline Perceptions. *Journal of Communication*, 56, 69–87. Retrieved from EBSCOhost.

## **Minimum Wage Level from Female Workers Perspective: Yogyakarta City Case**

**<sup>1</sup>Abdul Hakim, <sup>2</sup>Arief Darmawan**

<sup>1</sup>Fakultas Ekonomi, Universitas Islam Indonesia, [abdul.hakim.uui@gmail.com](mailto:abdul.hakim.uui@gmail.com), 081328118383

<sup>2</sup>Fakultas Ekonomi, Universitas Islam Indonesia, [052110101@uui.ac.id](mailto:052110101@uui.ac.id), 081392110777

### **Abstract**

Female workers have important roles in supporting the family's economy in Indonesia. The role is even more strategic since about half of Indonesian population are women. However, the important role of female workers have not been compensated at a decent wage, so that the female workers potentials have not been optimally occupied. This has motivated this paper to build an empirical model for determining the minimum wage level that female workers are willing to accept. Several factors that are considered to be the determinants of such a wage level are labor's education, type of jobs, access to finance, skills, as well as entrepreneurial spirit. A multiple regression model will be built for this purpose. If these factors can be appropriately identified, policies can be imposed by the government to determine the optimal wage level for such workers. The result can be used to motivate female workers to increase their bargaining power facing job offers in various industries. The increased bargaining power will be, eventually, followed by an increased in their skills. This will be beneficial both for workers and companies that hire them.

**Keywords:** Female workers, minimum wage level, education, access to finance, skills, entrepreneurial spirit.

**JEL Classification Numbers:** J31, J32, J33.

### **Introduction**

Female workers have an important role in supporting families in Indonesia. That role becomes particularly important given the low income of husbands and the high inflation, making the income value even lower from time to time. The contribution of female workers to their families have been significantly proven. The intensity of the female workers have also been investigated by Suseno and Hakim [22].

Almost 50% of Indonesia population is female, a huge human resource potential in economic development (Fadah and Yuswanto [5]). However, this potential has not been optimally utilized. Women contribute significantly to the economy and to improve the welfare of the household and the community. This is demonstrated by the role of women as housewives, as well as the role of them in supporting the family income (see, for example, Zulyanti [27]). Today, many Indonesian women doing work that used to be considered only men who can do it like being the driver, mechanic, laborer, astronauts, and even become president. They are trying to get a job to meet their needs. Female workers even involve in jobs that require energy or muscle (Angelina [2]).

Women consider a variety of factors when deciding to participate in the labor market. These factors are marriage status, age, area of residence (urban or rural), income, religion, education level, and income level of the husband (for married) (Fadah and Yuswanto [5]).

The government, as state officials, should care and be able to provide assistance for the poor. Several programs have been launched by the government in this regard, such as Jamkesna and Raskin. JAMKESNAS is a social assistance program for health care for the poor. Each JAMKESNAN participant has the right for basic health services include health care (outpatient and inpatient), and outpatient health services referral in advanced level, advanced level of hospitalization, and emergency services. Raskin is a food subsidy program as an attempt to improve food security and provide protection to the poor families through the distribution of rice. The rices is expected to reach poor families where each family can buy 10 to 20 kg of rice per month with a net price of Rp 1,000 per kg.

The minimum wage policies issued by the government is not always good for the economy in general. One suggestion is that the government should be neutral, in the sense of not siding with one party, namely the workers or employers. If the government is pro-worker, the employer might have trouble which, in the most severe scenario, shut down his company and led to the termination of employment. On the otherh and, if the pro-government is pro employer, the minimum wage will be really small that will be devastate the workers (see, for example, Suparjan and Suyatna [21]).

Given the vital role of female workers in the economy of the community in supporting the family economy, especially the grassroots population, but their wages are relatively low, this proposal plans to analyze the factors that determine the level of minimum wage workers are prepared to accept. This issue is of importance considering that female workers are still considered as second class workers, so they receive only marginal wages complae to male workers. Several factors are thought to be the determinant are the level of education, type of work they do that do not require high skills, limited access to finance, lack of skills, as well as the lack of entrepreneurial spirit.

The location of the study is the Municipality of Yogyakarta, so this research is a case study. Nevertheless, it is hoped that this study can be replicated in the county or other provinces in Indonesia, if it is assumed that the characteristic of economic structure in these places are not much different form those of Yogyakarta Municipality. In addition, this study confine themselves to the female non-managerial workers. This is motivated by the desire to empower the group, which currently still has a minimum level of welfare.

If these factors can be identified, the policies can be taken by the government to improve the level of wages received by female workers. These policies will include development in education and training system, enterpreneurship boosting, and access to investment funds, amont others. In the long term, it is expected that female workers would be able to increase their bargaining power to face job offers in various industries. In addition, the increase in female workers' bargaining power is an indication their increasing skill, which is imortant for companies, especially in the sense of human resource development.

## **Literature Review**

Research related to the wages of workers are currently focused on the collective bargaining power such as Dobbelaere [3] and Hirsch and Schnabel [6]. Other topics covered are gender-oriented workers' bargaining power (Agarwal [1]), the bargaining power of workers in relation to the capital structure (Kvistrum [11]), symptoms of labor allocation and inter-sectoral wage competitiveness in the industry monopolistic competition (Pompermeier [16]), female workers and demographic transition (Iyigun and Walsh [9]), or in relation to female workers as housewives (Doss [4]).

Various problems faced by female workers today are discrimination, sexual harassment in the workplace, overtime work without compensation, neglect of menstrual leave and maternity leave, dismissal of pregnant workers because the company did not want to bear the cost of labor, and their low salaries than male labor with a gap of about 17-22% (see Wardah [26]).

Research related to female workers are still a few in Indonesia. The topics that have been studied include female worker's contribution to the family income, the impact of women on family welfare workers, female workers productivity, as well as the intensity of female workers. The minimum wage for female workers perspective has also been the subject of study, but the minimum wage form the perspective of female workers, as far as the authors concern, has not been carried out, especially in Indonesia, particularly in the City of Yogyakarta.

Demographic and socioeconomic characteristics of female workers and their contribution to the family income has been investigated by Fadah and Yuswanto [5]. They found that the intensity of work is influenced by marital status and income. That the economic and non-economic motives motivate married women to work has been investigated by Septiningsih and Na'imah [19]. Using the method of embedded case study, they found that married women working for economic and non-economic motives. The contribution of female workers and the factors that affect labor income women has been investigated by Zulyanti [27]. By using multiple linear regression analysis, he showed that age, education, experience, and family responsibilities significantly affect female wokers income.

## **Theoretical Background**

Septiningsih and Na'imah [19] states that female workers are female who have regular or continuous activity within a specified period with a clear objective, namely to generate or to obtain something in the form of objects, money, services or ideas. According to Law No. 14 of 1969, labor is any person who is able to carry out work inside or outside the employment relationship in order to produce goods or services to meet the needs of the community.

Septiningsih also explains that the motivation that drives women to work, so that they should leave their family for a certain time, are to supplement the family income, to be economically independent on their husbands, to avoid boringness, to compensate the dissatisfaction in marriage, to apply skills that have been learned, to obtain a certain social status, and for self-development. Fadah and Yuswanto [5] adds the factors that motivate women to find jobs, ie, age, area of residence (urban or rural), income, religion, education level, income level of the husband (for the married ones), education, as well as the regional unemployment rate.

Work can be defined as an attempt to achieve goals. In terms of economics, work can be defined as an activity to produce goods or services, both for his own use or to obtain a reward. Work is basically a venue that allows human to express their ideas, create products, and form social networks. Humans exist not only for himself, but for others (Siregar [20]).

Female workers have some basic rights that must be protected by the state (Sari [18]). First, the right to equal payment for equal work. According to the International Labour Organization (ILO), the national average wage of women is slightly higher than two-thirds of the wages received by male workers. Second, the right to equal opportunities. This means that women have an equal opportunity to compete in all kinds of jobs, especially jobs that were previously not open to women. Third, the right to not receive discriminatory treatment in the workplace. Female workers also have the right to be free from all forms of inhumane treatment and freedom from discrimination are also entitled to fair working conditions and safety, as well as a decent income for themselves and their families. Fourth, the rights associated with reproductive function.

According to Law of Ministry No. 1, 1999, Article 1, paragraph 1, the minimum wage is the lowest monthly wage consists of basic salary including fixed allowances. This wage applies to those who are single and have a working experience of 0-1 years, serves as a safety net, established by Decree of the Governor on the recommendation of the Board Remuneration and valid for 1 year running.

According to Article 94 of Law No.13 of 2003 on Employment, wages consist of the basic wage and fixed allowances, where the amount of the basic wage is at least 75% of the basic salary and fixed allowances. Fixed allowance is an allowance which is paid on a regular basis and are not associated with the presence or of achievement.

If a female worker is offered a very low wage, she can choose not to work or do other activities that can help her family. The created unemployment, namely unemployment because workers do not like the terms of the work contract such as salaries, wages, and benefits, is called voluntary unemployment. If an unemployment is created because the workers really do not get the job, then he called involuntary underemployment.

Since a potential worker will consider the wage offered by the employer, in this case the company where she will work, it is necessary to learn the wage determination from the employer point of view.

## **Wages from Employers Point of View**

Various experts have examined the behavior of employers in wage setting. Krotz [10] mentions five stages in determining the wages of workers, namely (1) reviewing the remuneration practices that have been done, for example, based on a policy that has been done so far. (2) defines the work as clearly as possible. (3) Study the competitors, namely fellow employers. (4) Determine the salary range that can be given to certain types of work. (5) Making a salary as a part of a large package that also contains other benefits such as insurance, bonuses, and so on.

Lucas [12] stated that in order to avoid losses in determining wages, it is advisable for the employer to conduct the following steps. First, take enough time to consider the salary rate that will be

offered to the workers. Second, the employer should have a good relationship with fellow employers that have information about the level of wages that occurred in a particular type of work. Third, evaluate employees who have worked at your place, and give salary increases based on employee performance, not only by an increase in the cost of living. Fourth, in a volatile market, consider giving a bonus if it is necessary, because the bonus will be removed when the situation returns to normal.

Parker [13] stated that when companies hire employees, in general, he would pay twice the salary offered. Another component that must be spent by the company are taxes, a variety of benefits such as health insurance, pension, severance, and various other additional benefits, the cost of training and other related expenses.

Of the three questionnaires, representing a variety of studies that have been done, it appears that an employer will attempt to set salary in the most rational way. This applies both for prospective employees and employees who have worked a long time.

### **Wages from Workers Perspective**

To determine the salary to ask, Purdy [15] suggests to look for information about wages in similar jobs. If we know for certain the types of jobs we apply for, we should dare to mention the amount of salary. Otherwise, it would be better to wait for an offer.

Rynes et al. [17] found that money is not the only motivator and also not a primary motivator for workers. But they agreed that money is an important motivator. They also found that the way employees view money as their wages are also influenced by a variety of variables such as the variability of payment as well as the level of performance of each employee.

### **Methods**

This paper uses primary data. Interviews and prepared questionnaire are expected to encompass a wide range of information about the minimum wage they are willing to receive and factors expected to influence it.

A clear definite framework of population data are difficult to identify because of the nature of the distribution of workers to be investigated. However, this study attempts to find the best possible sample data, namely the sample that can be regarded as a representation of the data population. For this purpose, the sample collection method used is a random sampling method, which is one of the probabilistic sampling methods.

To obtain the answers consistency from businessmen and female workers, we will be built empirical models based on information from the aforementioned interviews and questionnaires. This analysis tool will also be able to provide information about significant variables determining the minimum wage from female workers perspective. The estimated regression model is as follows:

$$\begin{aligned}
 MWWR_i = & \beta_0 + \beta_1 EDU_i + \beta_2 EXPER_i + \beta_3 TR_i + \beta_4 CW_i + \beta_5 BEN_i + \beta_6 HI_i \\
 & + \beta_7 DEP_i + \beta_8 LA_i + \beta_9 NLA_i + \beta_{10} FUN_i + \beta_{11} INS_i + \beta_{12} GS_i + \varepsilon_i
 \end{aligned}
 \tag{1}$$

where

- MWWR* = Minimum Wage Women Received (Rp),
- EDU* = Education (years of schooling, starts from elementary school),
- EXPER* = Experience (month)
- TR* = Training (days),
- CW* = Current Wage (Rp)
- BEN* = Benefits other than salary received by the workers (Rp)
- HI* = Husband's income (Rp)



- DEP** = number of Dependence  
**LA** = Liquid asset (Rp)  
**NLA** = Non Liquid asset (Rp)  
**FUN** = Other source of funding, including from relatives (Rp)  
**INS** = Insurance (1 means has an insurance, 0 means NO)  
**GS** = Government Support (1 means receives government support, 0 means NO)

## Results and Discussion

The data for this pilot research covers 30 respondents from various location in Yogyakarta City. These respondents work as sales girls promotion in various malls, and various non managerial jobs in hospital and beauty salon. The statistics summary of the data are as follows. The minimum wage that female workers are willing to accept ranges from Rp 1,500,000 to Rp 3,000,000 with the mean of Rp 2,043,333.

The current wage that female workers ranges from Rp 1,300,000 to Rp 2,000,000 with the mean of Rp 1,660,000. In addition to the current wage they received, they also get some benefits in various ways from their employer. If the benefits are expressed in Rupiah, they range from Rp 125,000 per month to Rp 2,750,000 per month with the average of Rp 591,666.7 per month.

The years of education ranges from 12 years (high school graduate) to 15 years (graduate diploma), with the mean of 12.5 years. This means that most of them graduated from high school. The experience of working ranges from 7 months to 226 months with the average of 67 months (5,5 years). The other key characteristics of the respondents can be summarized from Table 1.

**Table 1.** Summary of Variables Statistics

	Minimum	Maximum	Mean
BEN	125,000	2,750,000	591,666.7
CW	1,300,000	2,000,000	1660,000
DEP	0	3	0.966667
EDU	12	15	12.5
EXPER	7	226	67.06667
FUN	0	1	0.4
GS	0	1.00E+00	2.33E-01
HI	0	4,000,000	666,666.7
INS	0	1	0.9
LA	15	18,000,000	8,883,334
MWWP	1,500,000	3,000,000	2,043,333
NLA	0	1.5E+08	8,333,333
TR	0	180	38.93333

Using OLS with heteroskedasticity consistent coefficient covariance of Newey-West technique to avoid both heteroskedasticity and serial correlation, we get the following results. The LM test for heteroskedasticity revealed that the model is free from such violation. The LM test for serial correlation revealed that the model is free from such violation, even though we can say that with 10% significance level, the model suffers the serial correlation.

The result of the estimation conclude that only education, experience, and insurance ownership influence the MWWP.

**Table 2.** Result of Estimation of Model 1

Variable	Coefficient	t-Statistic	Prob.
C	-1543257.	-1.580333	0.1325
EDU	228535.2	4.987503	0.0001
EXPER	1566.097	2.390538	0.0287
TR	-656.7690	-0.717479	0.4828
CW	0.059171	0.185461	0.8551
BEN	-0.094441	-1.833995	0.0842
HI	0.000903	0.043368	0.9659
DEP	54466.59	0.876563	0.3929
LA	0.008403	0.712753	0.4857
NLA	0.000891	1.432306	0.1702
FUN	132690.1	1.201884	0.2459
INS	496263.7	2.848016	0.0111
GS	-115488.6	-1.291602	0.2138
R-squared	0.629631	F-statistic	0.765005
Adjusted R-squared	-0.193411	Prob(F-statistic)	0.706462

**Table 3.** White Test for Heteroskedasticity of Model 1

F-statistic	0.765005	Probability	0.706462
Obs*R-squared	18.88894	Probability	0.529056

**Table 4.** Breusch-Godfrey Serial Correlation LM Test for Model 1

F-statistic	1.577871	Probability	0.238825
Obs*R-squared	5.214452	Probability	0.073739

To get rid of the problem of serial correlation, and also to increase the efficiency of the estimation, we delete the highly insignificant variables from the estimation. The remaining model is as follows:

$$MWR_i = \theta_0 + \theta_1 EDU_i + \theta_2 EXPER_i + \theta_3 BEN_i + \theta_4 DEP_i + \theta_5 NLA_i + \theta_6 INS_i + \xi_i \quad (2)$$

The LM test for both heteroskedasticity and serial correlation suggest that the model is free from both classical assumptions violations. The estimation results show that all variables are significance at 5%, except for DEP which is significance at 9%.

**Table 5.** Result of Estimation of Model 2

Variable	Coefficient	t-Statistic	Prob.
C	-1216002.	-2.073658	0.0495
EDU	226345.4	4.703596	0.0001
EXPER	1530.541	2.634079	0.0148
BEN	-0.134543	-3.074790	0.0054
DEP	42457.28	1.796223	0.0856
NLA	0.001183	2.030159	0.0541
INS	395637.2	10.45773	0.0000
R-squared	0.676138	F-statistic	8.002990

Adjusted R-squared	0.591652	Prob(F-statistic)	0.000097
--------------------	----------	-------------------	----------

**Table 6.** White Test for Heteroskedasticity of Model 2

F-statistic	0.982443	Probability	0.489523
Obs*R-squared	10.22511	Probability	0.420971

**Table 7.** Breusch-Godfrey Serial Correlation LM Test for Model 2

F-statistic	1.389776	Probability	0.271122
Obs*R-squared	3.506650	Probability	0.173197

It is clear that education is the dominant variable that determine the minimum wage female workers willing to receive (MWWP). Therefore, providing more education to the workers could be the primary policy to increase the wealth of such workers.

Experience is also important in determining the MWWP. However, there is nothing we could do about this variable, since experience comes with time. The benefit that is received from the employer has a negative impact on MWWP. This sign is clearly match with the expectation. This means that the higher the benefits, the less MWWP. This is because the employees are happy with low MWWP, as long as they can get higher benefits from the employer.

Non liquid assets also an important variables that influence the MWWP. The sign of the coefficient is positive, which means that the higher the non liquid assets, the higher MWWP they expect. This means that the higher non liquid assets made the workers more confidence to demand higher MWWP.

The ownership of insurance is very significant in determining the MWWP, with a positive sign. This is in contrast with the expectation. Probably, this phenomenon can be explained in the following way; the ownership of insurance made this workers feel confidence that they deserve to have higher salary, namely MWWP in this case.

## Conclusion

This paper investigated the nature of female workers in Yogyakarta City. It also intended to model the minimum wage female workers are willing to receive (MWWP). It found that the minimum wage that female workers are willing to accept ranges from Rp 1,500,000 to Rp 3,000,000 with the mean of Rp 2,043,333. The current wage that female workers ranges from Rp 1,300,000 to Rp 2,000,000 with the mean of Rp 1,660,000. In addition to the current wage they received, they also get some benefits in various ways from their employer. If the benefits are expressed in Rupiah, they range from Rp 125,000 per month to Rp 2,750,000 per month with the average of Rp 591,666.7 per month.

It found six variables influence MWWP, namely education, experience, benefits other than salary, number of dependence in the family, non liquid asset, and insurance ownership. The variables proven to be insignificant in determining the MWWP were training experience, current wage, husband income, liquid assets, funding from relatives, and government support.

## Acknowledgements

The authors acknowledge the funding receives from Direktorat Penelitian dan Pengabdian Masyarakat, Universitas Islam Indonesia, under the scheme of Unggulan Grant, 2014. The authors would like to thanks to all respondents that provide help in answering all the questions thoroughly and compassionately.

## References

- [1] Agarwal, B. (1977). Bargaining and Gender Relations: Within and Beyond the Household, Food and Nutrition Division (FCND). International Food Policy Research Institute, Discussion Paper No. 27.
- [2] Angelina (2009). Motivasi Tenaga Kerja Wanita, Can be down loaded from <http://wartawarga.gunadarma.ac.id>
- [3] Dobbelaere, S. (2005). Joint Estimation of Price-Cost Margins and Union Bargaining Power for Belgian Manufacturing, Institute for the Study of Labor (IZA). Discussion Paper No. 1466.
- [4] Doss, C. (2012). Intrahousehold Bargaining and Resource Allocation in Developing Countries, World Development Report, Gender Equality and Development, Background Paper.
- [5] Fadah, I. and Yuswanto, I.B. (2004). Karakteristik Demografi dan Sosial Ekonomi Buruh Wanita serta Kontribusinya Terhadap Pendapatan Keluarga (Studi Kasus pada Buruh Tembakau Di Kabupaten Jember). Accessed dari <http://puslit.petra.ac.id>.
- [6] Hirsch, B. dan Schnabel, C. (2011). Let's Take Bargaining Power Models Seriously: The Decline in Union Power in Germany, 1922-2009, Friederich-Alexander-Universitat Discussion Papers No. 73.
- [7] ILO Convention No. C111 (1958). International Labour Organization.
- [8] ILO Convention No. C111, ratifications (20014). International Labour Organization.
- [9] Iyigun, M. and Walsh, R.P. (2007). Endogenous Gender Power Household Labor Supply and the Demographic Transition, *Journal of Development Economics*, 82, 138-155.
- [10] Krotz, J.L. (2011). 5 Steps for Determining an Employee's Salary, Microsoft Business for Small and Midsize Companies, bisa dicari di [www.microsoft.com/business/en-us/resources/management/](http://www.microsoft.com/business/en-us/resources/management/).
- [11] Kvistrum, P. and Kagerman, H. (2012). Labor Bargaining Power and Capital Structure, Bachelor's Thesis, Stockholm School of Economics, Spring 2012.
- [12] Lucas, S. (2013). Are you Paying Your Employees Too Much? Inc. Com, can be downloaded from <http://www.inc.com/suzanne-lucas/are-you-paying-your-employees-too-much.html>.
- [13] Parker, T. (2013). How Much Does an Employee Really Cost? INTUIT Small Business Blog, NestEgg News, Wednesday, 16 October 2013 18:17, Can be Downloaded from <https://www.nestegg.com/news/item/49-how-much-does-an-employee-really-cost>.
- [14] Permen No. 01 Tahun 1999 tentang Upah Minimum, Menteri Tenaga Kerja Republik Indonesia.
- [15] Purdy, K. (2008). Know What Salary to Ask For in Your New Job, A Paper in Lifehacker, can be seen from <http://lifehacker.com/5041815/know-what-salary-to-ask-for-in-your-new-job>.
- [16] Pompermeier, A. (2003). Intersectoral Labour Allocation, Wage-employment Bargaining and Monopolistic Competition, CDAM Research Report LSE-CDAM-2003-11.
- [17] Rynes, S.L., Gerhart, B. and Minette, K.A. (2004). The Importance of Pay in Employee Motivation: Discrepancies between What People Say and What They Do, *Human Resource Management*, 43(4). 381-394.
- [18] Sari, D.I. (2004). Hak-Hak Sosial Ekonomi Buruh Perempuan: Realitas Kelabu di Tengah Setumpuk Konvensi, *Kalayanamedia*, 1(4). 12-14.
- [19] Septiningsih, D.S., and Na'imah, T. (2004). Studi Tentang Wanita Berkeluarga Yang Bekerja (Dampak Positif dan Hambatannya). *Jurnal Ilmiah Psikologi Psycho Idea*, ISSN No. 1693-1076.
- [20] Siregar, T. (2003). Pekerja Indonesia di Persimpangan Jalan, *Jurnal ALNI*, 78-79.
- [21] Suparjan and Suyatna, H. (2001). Kebijakan Upah Minimum yang Akomodatif, *Jurnal Ilmu Sosial dan Ilmu Politik*, 5(3). 298.
- [22] Suseno, A. and Hakim, A. (2013). Female Labor Working Intensity: A Study Case in A Construction Job, *Benefit* (forthcoming).
- [23] Undang-undang No. 39 Tahun 1999 (39/1999) Tentang Hak Asasi Manusia, Dewan Perwakilan Rakyat Republik Indonesia.
- [24] Undang-undang No. 7 Tahun 1984 (7/1984) Tentang Pengesahan Konvensi mengenai Penghapusan Segala Bentuk Diskriminasi terhadap Wanita, Dewan Perwakilan Rakyat Republik Indonesia.
- [25] Undang-undang No. 13 Tahun 2003 (13/2003) Tentang Ketenagakerjaan, Dewan Perwakilan Rakyat Republik Indonesia.

- [26] Wardah, F. (2003). Aktivist: Stop Diskriminasi Buruh Perempuan, *Voice of America*, Friday, 20 December 2013 Washington DC Time: 00:51, Downloaded 20, 12, 2013. Can be downloaded from <http://www.voaindonesia.com/content/aktivis-stop-diskriminasi-buruh-perempuan-/1776974.html>.
- [27] Zulyanti (2003). *Produktivitas Buruh Wanita Pabrik Rokok Penamas Malang*, Thesis, Universitas Muhammadiyah Malang, Can be Downloaded from <http://digilib.itb.ac.id>.

## **The Impact of price and income changes in nutrient intake in Urban Indonesia**

Agus Widarjono<sup>1</sup>

Lecturer at the Department of Economics, Islamic University of Indonesia  
Yogyakarta

email:[widarjonoagus@yahoo.com](mailto:widarjonoagus@yahoo.com)

Sarasri R Mumpuni Ruchba

Lecturer at the Department of Economics, Islamic University of Indonesia  
Yogyakarta

email:[mruchba@yahoo.com](mailto:mruchba@yahoo.com)

Majority of Indonesian households live in urban areas by 50.31 percent of total population in 2006 because of rapid urbanization since 1990. Rapid urbanization has changed food consumption as well as nutrient consumption. The purpose of this study is to estimate the macro nutrient consumption encompassing calorie, protein, fats and carbohydrate in urban areas. This study applied indirect approach using demand system. The model for demand system was Quadratic Almost Ideal Demand System (QUAIDS). Because the consumption patterns are different across the geographical areas and income level, the nutrient consumption was estimated separately between Urban Java and Off Java and different income level (low, medium and high income). The data used in this study were from the national social and economic survey of household (SUSENAS) in 2011. The results of nutrient consumption show most of nutrient price elasticities of ten food groups studied are negative. Nutrient-income elasticities are positive and become less elastic in moving from lower income to higher income households in both Java and off Java. As expected, simulation policies indicate poor families would suffer more than rich families from rising food price and/or decreasing income in both areas. Urban households on Java, however, are likely more vulnerable to nutrient deficiency than those urban households off Java as price and income changes.

**Keywords:** Urban Indonesia, QUAIDS, Demand Elasticity, and Nutrient Elasticity

### **1. Introduction**

One important indicator of society welfares is sufficient levels of nutrition consumed by human being. The amount of calories and protein consumed by each human being is used to measure Nutritional adequacy. The high rate of economic growth averaging 5% and rising incomes in the last 10 years has led to increased household consumption of calories and proteins. The level of calorie consumption was an average of 1849 kcal in 2013. The average household consumption of protein was 53.08 grams (CBS, 2014). Increased consumption of calories and proteins has been

---

<sup>1</sup> Corresponding author

continuing but not fully achieve an adequacy rate of calorie and protein consumption in Indonesia. The adequacy rate of calorie and protein intake of Indonesian people are set respectively by 2000 kcal and 52 grams per capita per day. If based on the standard of adequacy of calorie and protein consumption, average consumption of calories in Indonesia in 2013 was still below the standard of adequacy of calorie consumption. By contrast, average consumption of protein in the same year was above the adequacy standard of protein consumption.

Many previous studies on nutrient demand in Indonesia have been conducted such as Alderman and Timmer (1980), Moies (2003) and Skoufias (2003), Skoufias et al (2011) and widarjono (2012). With exception widarjono (2012), the previous researches were conducted before 2000. Widarjono investigated nutrient demand for the case in province level. Howeverm the rapid urbanization and increasing income leads to change the consumption pattern of Indonesian households. As a result, the change in food consumption behaviors also changes in nutrient availability and intake as well. The purpose of this study is to estimate the demand for nutrients in urban Indonesia focusing on macronutrient consisting of calories, protein, fats and carbohydrate using recent economic data.

The paper is written as follows. Section II discusses food and nutrient consumption patterns in urban Indonesia. Model specification and data are presented in section III. The next section discusses the results. The final section provides some conclusions and policy implications of this study.

## **2. Nutrient Consumption Pattern in Indonesia**

Nutrient can be classified as micro and macro nutrient. Micronutrient includes such as iron, iron, cobalt, chromium, copper, iodine, manganese, selenium, zinc and molybdenum. In other hand, macronutrient consists of calorie, protein, fat, and carbohydrate, minerals, vitamins and water.

Average per capita consumption of calories fluctuated over within 1999-2013. It has increased from 1,849.36 kcal in 1999 to 2,007.65 kcal in 2005 but it has been decreasing since 2006. It was 1926.74 kcal in 2013. Cereals were the largest contributor to calorie intake and were followed by oil and fats, prepared food and

beverage and beverage stuffs. Although the contribution of cereals to the calorie intake were quite dominant, but it has decreased from year to year. While the contribution of prepared food and beverage to calorie intake has continued to increase. Contribution of high-value foods such as fish, meat, eggs and milks, vegetables, fruits, oils and fats to calorie consumption continued to experience a steady increase. The contribution of tubers for consumption of calories has been coming down over that period.

Average per capita protein consumption was relatively stable during 1999-2013. It was less than 50 grams in 1999 but it was 54.45 in 2000. Protein consumption then has been increasing and it was 53.08 grams in 2013. On average over those periods, the contribution of each food items ranged from 0 grams for tobacco and betel to 23.22 grams for cereals. Like calorie intake, cereals was the largest contributor to the consumption of protein and was followed by a fish, prepared food and beverage, and legumes. Contribution of meat, eggs and milks, and vegetables to protein intake as the high-value foods was steadily growing. While the contribution of other food groups to protein intake were relatively small by less than 1 gram per day.

### **3. Model Specification and Data**

#### **3.1. Model Specification**

The indirect method was used to estimate nutrient demand in urban Indonesia. The first step of this study was to estimate the demand elasticities and in the second step nutrient nutrient elasticities were estimated based on information available from demand elasticity. The two-stage budget procedures are used to estimate food demand assuming that food is weakly separable from non-food (Deaton and Muellbauer, 1980). In the first-stage budgeting, total household expenditures are spent among food and non-food items. In the second stage budgeting, food household expenditures are spent among the each food group.

This study applied the Working-Leser model in the first-stage budgeting to calculate demand elasticity as follows:

$$w_i = \omega_o + \omega_1 \ln X + \sum_{j=1}^n \rho_{ij} \ln p_j + \sum_{k=1}^n \pi_{ik} Z_k + \varepsilon_i \quad (1)$$



where  $i$  and  $j$  are goods,  $w_i$  is the share of total expenditure allocated to the  $i$ th good,  $p_j$  is the price of the  $j$ th good,  $X$  is the household expenditures on goods,  $\mathbf{Z}_k$  is the demographic variables consisting of household size, years of schooling of household head, age of household head, gender of household head, urban dummy variables, and two quarter dummy variables.

The price ( $\eta_{ij}$ ) and expenditure ( $\eta_i$ ) elasticities in the first -stage budgeting are:

$$\eta_{ij} = \frac{\rho_{ij}}{w_i} - \delta_{ij} \quad (2)$$

$$\eta_i = 1 + \frac{1}{w_i} [\omega_i] \quad (3)$$

where  $\delta_{ij}$  is the Kronecker Delta (0 if  $i \neq j$  and 1 otherwise). Both prices and expenditure elasticities are evaluated at sample means. This study used Engle equation to calculate income elasticity as follow:

$$\ln x = \tau_0 + \tau_1 \ln Y + \delta \ln P + \sum_{k=1}^n \rho_{ik} \mathbf{H}_k + \mu_i \quad (4)$$

where  $x$  is the household expenditures on foods,  $Y$  is total household expenditure on both food and non-food,  $P$  is price index of foods, and  $\mathbf{H}_k$  is the demographic variables that are same as previously defined in equation (1). Following Chern et al (2003), the income elasticity can be estimated as:

$$\xi_i = \eta_i \tau_1 \quad (5)$$

A quadratic almost ideal demand system (QUAIDS) (Banks et al, 1997) is used in the second-stage budgeting given as:

$$w_i = \alpha_i + \sum_{j=1}^n \gamma_{ij} \ln p_j + \beta_i \ln \left( \frac{X}{a(P)} \right) + \frac{\lambda_i}{b(P)} \left( \ln \left[ \frac{X}{a(P)} \right] \right)^2 + u_i \quad (6)$$

where  $i$  and  $j$  are goods,  $w_i$  is the share of total expenditure allocated to the  $i$ th good,  $p_j$  is the price of the  $j$ th good,  $X$  is the household expenditure on goods in the system,  $a(P)$  is the price index defined as

$\ln[a(P)] = \alpha_0 + \sum_{i=1}^n \alpha_i \ln p_i + 0.5 \sum_{i=1}^n \sum_{j=1}^n \gamma_{ij} \ln p_i \ln p_j$ ,  $b(P)$  is the Cobb-Douglas price aggregator given by  $b(P) = \prod_{i=1}^n p_i^{\beta_i}$ ,  $\gamma_{ij}$ ,  $\beta_i$ , and  $\lambda_i$  are parameters to be estimated, and  $u_i$  is an error term.

We incorporate demographic variables into the intercept in equation (6) to capture demographic variables in estimating demand for food as defined  $\alpha_i = \rho_{i0} + \sum_{k=1}^m \rho_{ik} d_k$  where  $d_k$  is the demographic variables consisting of household size,

educational level of household head (years of schooling), age of household head, gender of household head, and two quarter dummy variables (Quarter 2 and quarter 3).

The properties of neoclassical demand theory consisting adding-up, homogeneity and slusky symmetry can be imposed on equation (6) by restricting its parameters ( Banks et al, 1996). The adding-up restriction is given by  $\sum_{i=1}^n \rho_{i0} = 1$ ;  $\sum_{i=1}^n \rho_{ik} = 0$ ;  $\sum_{i=1}^n \gamma_{ij} = 0$ ;  $\sum_{i=1}^n \beta_i = 0$ ; and  $\sum_{i=1}^n \lambda_i = 0$ ; homogeneity is imposed as  $\sum_{i=1}^n \gamma_{ij} = 0$  for any  $i$ ; and Slutsky symmetry is defined by  $\gamma_{ij} = \gamma_{ji}$ ,  $i \neq j$ .

SUSENAS data that were used in this study provide some contain some zero expenditures for a given food expenditure during the survey. If the dependent variables in the demand system contain zero expenditure, the appropriate model is limited dependent variable or censored model. Therefore, the QUAIDS model in the second-stage budgeting is the censored model and causes biased estimation (Heien & Wessels 1990). The consistent two- step estimation procedure proposed by Shonkwiler and Yen (1999) is applied to solve biased estimation. Probit model is used to determine the probability of buying a given type of food in the first step with some explanatory variables encompassing the logarithms of prices of studies food groups, the logarithms of total household expenditure and demographic variables that are same as those used in equation (6). Finally, the estimated standard normal probability density function ( $\phi$ ) and the estimated standard normal cumulative distribution function ( $\Phi$ ) from the first-step estimation are incorporated in the QUAIDS model and defined as (Shonkwiler & Yen 1999):

$$w_i = \{\alpha_i + \sum_{j=1}^n \gamma_{ij} \ln p_j + \beta_i \ln \left( \frac{X}{a(P)} \right) + \frac{\lambda_i}{b(P)} \left( \left[ \frac{X}{a(P)} \right] \right)^2 + u_i\} \Phi(\cdot) + \tau_i \phi(\cdot) + \varepsilon_i \quad (7)$$

The adding-up condition does not hold in the system of equations (7). Estimation of system equation (7) should be estimated on entire  $n$  equations in the demand system (Yen et al. 2002). Following Bank et al (1997), the Marshallian price and expenditure elasticities of the QUAIDS model with censoring model in the second-stage budgeting are calculated as follows:

$$e_{ij} = \frac{1}{w_i} \left\{ \gamma_{ij} - \left( \beta_i + \frac{2\lambda_i}{b(P)} \left[ \ln \left( \frac{X}{a(P)} \right) \right] \right) \left( \alpha_{ih} + \sum_{j=1}^n \gamma_{ij} \ln p_j \right) - \frac{\lambda_i \beta_j}{b(P)} \left( \ln \left[ \frac{X}{a(P)} \right] \right)^2 \right\} \Phi_i - \delta_{ij} \quad (8)$$

$$e_i = 1 + \frac{1}{w_i} \left[ \beta_i + \frac{2\lambda_i}{b(P)} \ln \left( \frac{X}{a(P)} \right) \right] \Phi_i \quad (9)$$

where  $\delta_{ij}$  is the Kronecker delta (0 if  $i \neq j$  and 1 otherwise). All price and expenditure elasticities in QUAIDS model are evaluated on the basis of parameter estimated and sample means of independent variables using equation (8) and (9). Standard errors of both price and expenditure elasticities are calculated using the delta method.

Both price and expenditure elasticities of demand for food groups in the second-state budgeting are conditional on total goods expenditure in the first-stage budgeting. Unconditional price ( $\Omega_{ij}$ ) and expenditures ( $\Omega_i$ ) elasticities are calculated as (Edgerton 1997):

$$\Omega_{ij} = e_{ij} + e_i[w_j + \eta_{ij}w_j] \quad (10)$$

$$\Omega_i = e_i \eta_i \quad (11)$$

where  $e_{ij}$  is the conditional Marshallian price elasticity,  $e_i$  is the conditional expenditure elasticity for  $j$ th food groups,  $\eta_{ij}$  is the Marshallian price elasticity of food in the first-stage budgeting,  $w_j$  is the expenditure share of  $j$ th food groups, and  $\eta_i$  is the unconditional expenditure elasticity for food in the first-stage budgeting. Finally, the income elasticity for  $i$ th food groups is given (Park et al, 1996):

$$\Psi_i = \Omega_i \xi_i \quad (12)$$

where  $\Omega_i$  is the unconditional expenditure elasticity for  $i$ th commodity within food groups and  $\xi_i$  the income elasticity of food in the first-stage budgeting.

The second step of this study is to calculate nutrient elasticity both nutrient-price and income elasticities. Following Huang (1996, 1999), nutrient-price and income elasticities are

$$\pi_{kj} = \sum_i \Omega_{ij} a_{ki} q_i / \phi_k \quad (13)$$

$$\eta_k = \sum_i \Omega_i a_{ki} q_i / \phi_k \quad (14)$$

where  $\pi_{kj}$  is the nutrient-price elasticity,  $\eta_k$  is the nutrient-income elasticity,  $a_{ki}$  is the amount of the  $k$ th nutrient obtained from a unit of the  $i$ th food,  $q_i$  is quantity consumed and  $\phi_k$  is the total amount of that nutrient obtained from various food and it is calculated as  $\phi_k = \sum_i a_{ki} q_i$ .

### **3.2. Data**

The data set for this study was collected from the national social and economic survey of household in Indonesian (SUSENAS). The Central Bureau of Statistics (CBS) conducts the SUSENAS survey every year. However, expenditure questions are collected every three years and SUSENAS 2011 was latest survey associated with expenditure survey. For this study, data include household survey form quarter 1 to quarter 3 and only households living in urban areas on Java and off Java are used. The total number of households living in urban is 88,049 households. Households living in urban on Java and off Java are 39.247 and 48.792 respectively. Households then are regroup based on their income level consisting low, middle and high income level. Following Central Bureau Statistics (CBS), 40 percent of the lowest expenditures household is classified as low income (poor household), 40 percent of medium household expenditure is considered as middle income (medium household) and 20 percent of the highest household expenditure is grouped as high income (rich household).

This study used SUSENAS 2011 and consists of 215 food commodities. The CBS classifies food consumption into 14 group foods. For the purpose of this study, we regroup 14 groups to 10 food groups according to similar nutritional components. The 10 food groups consist of : (1) cereal encompassing cereals and tubers; (2) fish; (3)meat; (4) eggs and milk; (5) vegetables; (6) fruits; (7) oil and fats encompassing oils and fats and legumes; (8) prepared food and drink encompassing beverages and prepared food;(9) other foods encompassing spices and miscellaneous foods; and (10) tobacco products. Non-food expenditures consist of 6 commodity groups encompassing housing and household facility, goods and services, clothing, footwear, and headgear, durable goods, taxes and insurance, and parties and ceremony.

The SUSENAS provides information prices for each food commodities. The weighted average of price within groups using budget share as a weight is used to calculate aggregate price for each food groups (Moschini, 1995). If missing or unreported aggregate price exists, this price was calculated by regressing observed prices on regional dummies, seasonal dummies, and income (Jensen and Manrique,

1998). Total household expenditure is used as a proxy for income (Deaton, 1996; and Moeis, 2003).

In the first-stage budgeting, this study estimate demand for food and non-foods. Monthly food and non-food expenditures data are used in estimating food and non-foods in the first-stage budgeting. However, the SUSENAS does not provide information prices for non-food expenditures. Following study of Jensen and Manrique (1998), this study uses consumer price indexes for non-food items. The aggregate price for the non-food commodity group was calculated using an average of the consumer price indexes for non-food items in each province. If a province has more than one city, the aggregate price for the non-food in each province was calculated as average of those cities.

## **4. Results and Discussion**

### **4.1. Demand Elasticity**

The Working -Leser model in the first-stage budgeting consisting of food and non-food commodity group was estimated using the Ordinary Least Squares (OLS). Food demand in the first step demand system was run separately for the different income groups for both urban on Java and off Java. Then, price and expenditure elasticities of food were calculated from the estimated parameter of the Working -Leser model using equation (2) and (3). Finally, expenditure elasticities available from Working-Leser model and Engle Function could be used to derive income elasticity by applying equation (5). The first-step demand system provides an unconditional price and expenditure elasticities of food in the first-stage budgeting.<sup>2</sup>

The demand system in the second-stage budgeting consists of food groups encompassing cereals, fish, meat, eggs and milk, vegetables, fruits, oil and fats, prepared food and drink, other foods and tobacco product. SUSENAS 2011 provide some zero expenditures for a given food expenditure during survey in urban area. Zero expenditures for cereals, fish, meats, eggs and milks, vegetables, fruits, oil and fats, prepared foods and drinks, other foods and tobacco products are 4.35%, 15.54%, 51.60%, 14.62%, 7.86%, 23.25%, 6.57%, 0.21%, 4.45%, and 37.36% respectively. In order to avoid bias estimated parameters because of zero observation in the demand

---

<sup>2</sup> The estimations and results in the first-stage budgeting are available upon request

system, the consistent two-step estimation procedure was employed. In the first-step estimation, Probit model were applied to estimate the studied food groups separately using maximum likelihood to calculate CDF and PDF. In the second-step estimation, food demand of ten food groups were estimated by including CDF and PDF in the QUAIDS using Full Information Maximum Likelihood estimation (FIML) with imposition of homogeneity and symmetry condition.

According to two-stage budgeting approach in estimating demand elasticities, the price and expenditure elasticities for the studied food group in the second-stage budgeting are conditional upon both price and expenditure elasticities in the first-stage budgeting<sup>3</sup>. Of interest demand elasticities in this study are unconditional demand elasticities and were calculated using equation (10), (11) and (12). Unconditional price, expenditure and income elasticities of the ten food groups for urban on Java are shown in Table 1. All the own-price elasticities are negative and these results are consistent with demand theory. The own-price elasticity are inelastic for the medium to high income but meat, eggs and milks, fruits, prepared food and drink and tobacco products are elastic for lower income. Cereals with rice as one subgroup is high responsive to price changes for low income but it is less responsive to price changes for higher income households. These findings are similar to previous study such as Jansen and Manrique (1998), Moies (2003), Pangaribowo and Tsegai (2011). The demand for high-value foods such as fish, meat, eggs and milks, vegetables, fruits, and oil and fats are more sensitive to price changes than other food group across income level. The meat as the most expensive food is inelastic for rich household but it is elastic for poor households. In general, lower income households are more responsive to price changes than those higher income households.

With exception prepared food and drink for low income households, the all unconditional expenditure elasticities are positive but inelastic. However, the main concern of economic policy is income elasticity instead of expenditure elasticity. All income elasticities are positive but inelastic (necessity goods) and relatively stable across income levels. Prepared food and drink are most responsive to income change for all income level. The income elasticities of cereal group as staple food are relatively

---

<sup>3</sup> The estimations and results in conditional demand elasticities are available upon request .

low compared to other food groups across income strata. Most of high value food such as fish, meat eggs and milks, vegetables, fruits, and oil and fats are less sensitive to income changes across income level compared to other food groups. Broadly speaking, income elasticity becomes more elastic as moving to lower income households.

Uncoditional demand elasticities for urban off Java are shown in Table 2. Like urban on Java, all the own-price elasticities are negative and inelastic with exception fruit and oils and fats for low income groups and high income respectively. Higher income households are less responsive to price changes than those lower income households. Cereals as staple food are less responsive to price changes for low income but more responsive to price changes moving to higher income households. Meat is inelastic for poor households but it is elastic for higher income households. Demand for rice for urban families off Java is less responsive to price change compared to urban families on Java. Estimated own-price elasticity for high-value foods such as fish, eggs and milks, vegetables, fruits, and oil and fats in urban off Java are less sensitive to price compared to urban on Java across income level. In general, urban households off Java generally show less own-price elasticities than urban households on java.

All food groups have income elasticities smaller than unity (necessity good). Income elasticity becomes more elastic as moving to lower income households. Prepared food and drink are most responsive to income change for all income levels. The income elasticities of cereal group as staple are more elastic moving from higher to lower income groups. More importantly, demand for cereals in urban off Java are more responsive to income change than those urban on Java. Most of fish, meat, eggs and milks, vegetables, fruits, and oil and fats as high value food have income elasticity smaller than other food groups. However, income elasticities of those high value food for urban off Java are generally higher than urban on Java. In general, urban households off Java are more responsive to income changes than urban households on Java.

#### **4.2. Nutrient Elasticity**

Calorie and protein- income and price elasticities of 10 food group across income strata are presented in Table 6. Table 6 is divided by two parts where the top part show

calorie and protein-price elasticity and the bottom part indicate calorie and protein-income elasticity. Calorie-price elasticity of cereals are negative across income groups. Because cereals are a staple food, an increase in price of cereals lowers demand for cereals and accordingly reduce calorie intakes. However, low income households reduce most calorie consumption than other household. Prices of eggs and milks, oils and fats, prepared food and drink, other food have negative impact on nutritional availability across income groups. Calorie-price elasticities of other food groups such as fish and meat have a positive sign. An increase in price of those product increases calorie consumption through substitution effect by increasing demand for other food. Tobacco does not contain nutritional effects such as calorie and protein. However, its calorie-price elasticity has positive for low and medium income household because of cross commodities effect. Calorie intake is most responsive to change in price of eggs and milks as compared to other studied foods. In general, most of calorie-price elasticity (18 of 30) are negative and become less elastic in moving from lower to higher income households. These findings imply that an increase in price of 10 food groups decrease calorie consumption and lower income households reduce more calorie intake. Calorie-income elasticities are positive across income groups but become more elastic from higher income to lower income households. Therefore, lower income households get more nutritional benefit for increasing income.

Table 6. Calorie and Protein Elasticity by Income Groups, Central Java, 2011

	Calorie			Protein		
	Low	Middle	High	Low	Middle	High
Price of						
Cereal	-0.3855	-0.2882	-0.2249	-0.3295	-0.2341	-0.1805
Fish	0.0282	0.2258	0.0195	-0.0202	0.1661	-0.0362
Meat	0.2298	0.1337	0.0256	0.1973	0.0927	-0.0174
Eggs and milks	-0.4268	-0.4209	-0.2400	-0.3600	-0.3467	-0.1758
Vegetables	-0.0184	0.0007	0.0443	-0.0540	-0.0263	0.0196
Fruits	-0.0240	0.1306	0.0196	0.0082	0.1544	0.0397
Oils and fats	-0.0664	-0.1440	-0.1009	-0.0666	-0.1298	-0.0856
Prepared food and drink	-0.3284	-0.2525	-0.2655	-0.2942	-0.2146	-0.2353
Other foods	-0.1113	-0.0248	-0.0393	-0.0976	-0.0228	-0.0217
Tobacco	0.0766	0.0441	-0.0161	0.0739	0.0421	-0.0110



Income	0.7301	0.5416	0.0493	0.7107	0.5203	0.0481
--------	--------	--------	--------	--------	--------	--------

Source: estimated using the 2011 SUSENAS

Protein-price and income elasticities have same patterns as calorie-price and income elasticities but most of their magnitudes are smaller than calorie elasticity. Protein-price elasticity of cereals are negative across income level and became inelastic as income increases. As expected, magnitude of protein-price elasticity of cereals is smaller than calorie-price elasticity. Protein consumption is also most responsive to change in price of eggs and milks. Protein-price elasticity of tobacco has only negative for high income households. Among 30 protein-price elasticity, 21 elasticities are negative. Like calorie, protein-price elasticities are more elastic from higher income to lower income households. As results, if price of 10 studied foods increase households decrease their protein consumption but lower income household would reduce more protein consumption. Calorie-income elasticities are also positive across income groups but become more elastic from higher income to lower income households. Lower income households consume more protein than higher income household as income increases.

### **4.3. Simulation Policy**

## **5. Conclusions and Policy Implications**

This study estimates calorie and protein elasticity in Central Java using indirect method developed by Huang (1996,1999). Household survey data SUSENAS in 2011 are used. Calorie and protein elasticities of 10 food groups are estimated across income groups. Most of calorie and protein-price elasticities are negative so that whenever price of studied foods go up households in Central Java would reduce calorie and protein consumption. Calorie and protein intake are most responsive to change in prices of eggs and milks as compared to other foods. More importantly, calorie and protein-price elasticity of cereals as staple food with rice as one subgroup are negative. These results suggested that as the price of rice goes up, people face nutritional

deficiency. Calorie -price elasticities of 10 studied foods are more elastic than protein-price elasticities. Calorie and protein-income elasticity are positive and become more elastic from higher income to lower income households. Calorie is more responsive to income change than protein.

Because most of calorie and protein-price elasticity of 10 studied food are negative and calorie consumption in Central Java was below standard of adequacy, some price policies should be addressed in facing undernutrition problem. First, maintaining affordable rice as staple food is critical for population well-being in Central Java. The Government of Central Java must maintain surplus staple foods such as rice, corn and cassava in order to stabilize the price of staple foods. Second, since calorie and protein intakes are most responsive to price of eggs and milks, stabilizing the price of eggs as one subgroup of egg and milk group is also important in solving undernutrition issues in Central Java.

## REFERENCES

- Alderman, H. C., and C. Peter Timmer. 1980. "Food Policy and Food Demand in Indonesia." *Bulletin of Indonesian Economic Studies* 16: 83-93.
- Banks, J., R. Blundell, and A. Lewbel. 1997. "Quadratic Engle Curves and Consumer Demand." *The Review of Economics and Statistics* 79 :527-39.
- Blundell, R., and J.M. Robin. 1999. "Estimation in Large and Disaggregated Demand System: An Estimator for Conditionally Linear System." *Journal of Applied Econometrics* 14:209-32.
- Cern, S. Wen, K. Ishboshi, K. Taniguchi and Y. Tokoyama. 2003. Analysis of Food Consumption Behavior by Japanese Households. Food and Agricultural Organization: Economic and Social Development, Paper 152.
- Central Bureau of Statistics (CBS). *Statistical Yearbook of Indonesia, 2008-2012*.
- Deaton, Angus and J. Muellbauer. 1980. "An Almost Ideal Demand System." *American Economic Review* 70: 312-26.
- Deaton, Angus. 1990. "Price Elasticities from Survey Data: Extension and Indonesian Results." *Journal of Econometrics* 44:281-309.
- Edgerton L. David. 1997. " Weak Separability and the Estimation of Elasticities in Multistage Demand System." *American Journal of Agricultural Economics* 79: 62-79.
- Food Security Bureau of Central Java (Badan Ketahanan Pangan). www
- Green, W. H. 2012. *Econometric Analysis*, 12<sup>th</sup> edition. Boston: Prentice Hall.
- Hein, D. and C. R. Wessels. 1988. "Demand for Dairy Products: Structure, Prediction, and Decomposition." *American Journal of Agricultural Economics* 70: 219-28.
- Hein, D. and C. R. Wessels. 1990. "Demand System Estimation with Microdata: A Censored Regression Approach." *Journal of Business and Economic Statistics*, 8: 365-71.
- Huang, Kuo S. 1996. "Nutrient Elasticities in a Complete Food Demand System." *American Journal of Agricultural Economics* 78: 21-29.
- \_\_\_\_\_. 1999. "Effect of Food Prices and Consumer Income on Nutrient Availability." *Applied Economics* 31 :367-80.
- Jensen, Helen H., and Justo Manrique. 1998. "Demand for Food Commodities by Income Groups in Indonesia." *Applied Economics* 30 : 491-501.
- Leser, C.E. 1963. "Forms of Engle Functions." *Econometrica* 31: 694-763.
- Moeis, J. Peananta. 2003. "Indoesian Food Demand System: An Analysis of the Impact of the Economic Crisis on Household Consumption and Nutritional Intake." Unpublished Doctor of Philosophy's Dissertation. The Faculty of Columbian College of Art and Sciences, Gorge Washington University.
- Moschini, G. 1995. "Unit of Measurement and the Stone Index in Demand System Estimation." *American Journal of Agricultural Economics* 77: 63-68.
- Park, John L., R. B. Holcomb., K. C. Raper., and O. Capps, Jr. 1996. "Demand System Analysis of Food Commodities by US Households Segmented by Income." *American Journal of Agricultural Economics* 78: 290-300.
- Shonkwiler, J.S., and S.T. Yen. 1999. "Two-Step Estimation of a Censored System of Equations." *American Journal of Agricultural Economics* 81: 972-82.

- Skoufias, Emmanuel. 2003. "Is the Calorie-Income Elasticity Sensitive to Price Changes? Evidence from Indonesia." *World Development* 31: 1291-307.
- Skoufias, Emmanuel, Sailesh Tiwari and Hasan Zaman. 2011. "Crisis, Food Prices, and the Income Elasticity of Micronutrient: Estimates from Indonesia." *The World Bank Economic Review* : 1-28.
- Widarjono, Agus. (2012). "An Analysis Of Protein And Calorie Consumption In Central Java," *Economic Journal of Emerging Markets* 4:115-126.
- Working, H. 1943. "Statistical Laws of Family Expenditure." *Journal of the American Statistical Association* 33:43-56.
- Yen, S. T., K. Kan and Shew-Jiuan Su. 2002. "Household Demand for Fats and Oils: Two Step Estimation of a Censored Demand System." *Applied Economics* 14 : 1799-1806.
- Yen, S.T., B. Lin., and D.M. Smallwood. 2003. " Quasi-and Simulated-Likelihood Approaches to Censored Demand Systems: Food Consumption by Food Stamp Recipients in the United States." *American Journal of Agricultural Economics* 85: 458-78.

Table 1. Own-Price and Expenditure Elasticity by Income Groups,  
The Second-Stage Demand, Urban Java, Indonesia, 2011

Food Groups	Own-Price Elasticity			Expenditure Elasticity			Income Elasticity		
	Low	Middl	High	Low	Middl	High	Low	Middl	High
		e			e			e	
Cereal	-0.833	-0.485	-0.509	0.751	0.634	0.408	0.552	0.344	0.063
Fish	-0.961	-0.791	-0.659	0.600	0.669	0.422	0.441	0.363	0.065
Meat	-1.001	-0.552	-0.580	0.912	0.460	0.339	0.670	0.250	0.052
Eggs and milks	-1.004	-0.825	-0.797	0.557	0.703	0.416	0.409	0.381	0.064
Vegetables	-0.796	-0.875	-0.832	0.601	0.708	0.403	0.441	0.384	0.062
Fruits	-1.079	-0.830	-0.706	0.834	0.455	0.316	0.612	0.247	0.049
Oils and fats	-0.893	-0.971	-0.947	0.683	0.670	0.469	0.501	0.364	0.073
Prepared food and drink	-1.016	-0.948	-0.860	1.129	0.958	0.652	0.829	0.520	0.101
Other foods	-0.725	-0.677	-0.665	0.980	0.738	0.464	0.720	0.401	0.072
Tobacco	-1.003	-0.881	-0.929	0.847	0.730	0.497	0.622	0.396	0.077
Mean	-0.931	-0.784	-0.748	0.789	0.672	0.439	0.580	0.365	0.068

Source: estimated using the 2011 SUSENAS

Table 2. Own-Price and Expenditure Elasticity by Income Groups,  
The Second-Stage Demand, Urban Off Java, Indonesia, 2011

Food Groups	Own-Price Elasticity			Expenditure Elasticity			Income Elasticity		
	Low	Middl	High	Low	Middl	High	Low	Middl	High
		e			e			e	
Cereal	-0.488	-0.771	-0.636	0.872	0.695	0.446	0.635	0.376	0.062
Fish	-0.604	-0.744	-0.729	0.859	0.725	0.443	0.625	0.392	0.061
Meat	-0.405	-0.923	-0.888	0.624	0.571	0.353	0.455	0.309	0.049
Eggs and milks	-0.670	-0.836	-0.802	0.779	0.676	0.432	0.567	0.365	0.060
Vegetables	-0.764	-0.648	-0.705	0.753	0.561	0.312	0.548	0.303	0.043
Fruits	-1.044	-0.836	-0.720	0.774	0.555	0.403	0.563	0.300	0.056
Oils and fats	-0.841	-0.880	-1.029	0.739	0.586	0.573	0.538	0.317	0.079
Prepared food and drink	-0.823	-0.800	-0.814	1.087	1.016	0.644	0.791	0.549	0.089
Other foods	-0.487	-0.692	-0.708	1.024	1.011	0.564	0.745	0.546	0.078
Tobacco	-0.921	-0.650	-0.873	0.818	0.671	0.477	0.596	0.363	0.066
Mean	-0.705	-0.778	-0.790	0.833	0.707	0.465	0.606	0.382	0.064

Source: estimated using the 2011 SUSENAS

Table 3.

	Nutrient Price Elasticity of										
	Nutrient Income elasticity	Cereal s	Fish	Meat	Eggs and Milk	Vegetable s	Fruits	Oils and Fats	Prepare d food and drink	other foods	Tobacco products
<b>Calorie</b>											
Low income	0.6214	-0.3903	0.0634	-0.0149	-0.3508	0.0742	-0.0074	-0.0886	-0.3083	-0.1126	0.0035
Middle income	0.3972	-0.1974	-0.0093	0.0323	-0.3281	0.0004	0.0482	-0.0609	-0.3003	-0.0540	-0.0033
High Income	0.0751	-0.1696	-0.0109	0.0225	-0.2399	0.0324	0.0417	-0.0848	-0.2436	-0.0691	0.0244
<b>Protein</b>											
Low income	0.6046	-0.3242	-0.0039	-0.0289	-0.2814	0.0473	0.0047	-0.0809	-0.2802	-0.0947	0.0038
Middle income	0.3935	-0.1571	-0.0720	0.0153	-0.2590	-0.0097	0.0621	-0.0437	-0.2691	-0.0385	-0.0027
High Income	0.0736	-0.1311	-0.0691	-0.0029	-0.1727	0.0244	0.0478	-0.0434	-0.2233	-0.0542	0.0231
<b>Fats</b>											
Low income	0.6304	-0.0802	0.0562	0.0119	0.0127	0.0252	0.0145	-0.3098	-0.3340	-0.0751	0.0077
Middle income	0.4074	-0.0180	0.0024	0.0885	-0.0394	-0.0018	0.0539	-0.3013	-0.3040	-0.0283	0.0080
High Income	0.0764	-0.0099	0.0139	0.0335	-0.0084	0.0258	0.0554	-0.2884	-0.2365	-0.0470	0.0293

Source: Source: estimated using the 2011 SUSENAS

# The Effect Accounting Conservatism on the Company's Performance and Information Asymmetry as a Moderator: Evidence From Indonesia and Singapore

Nera Marinda Machdar<sup>1</sup>

Sekar Mayangsari<sup>2</sup>

<sup>1</sup>Department of Accounting, Kalbis Institute

<sup>2</sup>Department of Accounting, Trisakti University

## Abstract

The purpose of this study is to examine the influence of accounting conservatism on the company's performance and to test whether the effect of information asymmetry strengthen the relationships of accounting conservatism on the company's performance. The samples used by 298 manufacturing companies, consisting of 129 companies listed in Indonesia Stock Exchange (IDX) and the 169 companies listed on the Singapore International Monetary Exchange (SIMEX). The study used the financial statements for the period 2004 to 2013. The results show that (a) accounting conservatism will negatively affect the company's performance; (b) differential timeliness will negatively affect the company's performance; (c) hidden reserves will negatively affect the company's performance; and (d) information asymmetry strengthens the effect of accounting conservatism on the company's performance.

**Keywords:** *Accounting Conservatism, Information Asymmetry, Differential Timeliness, Hidden Reserve, Stock Return, Cash Flow Operation.*

## 1 Introduction

Conservatism principle has been traditionally used in financial reporting for long time and it has been dominant accounting principles (Watts 2003). Basu (1997) interpreted that conservatism as capturing the tendency of accountant to require a higher degree of verification for recognizing good news than bad news in financial statements. It means that earnings reflect bad news more quickly than bad news. Penman and Zhang (2002) contended that traditionally financial reporting is based on conservatism principle which requires anticipating all possible losses and writes them off in unfavorable period and underestimate gains in favorable period. Although accounting conservatism has increased in recent decades, but conservatism has been controversial among researchers.

In recent years, the focus of standard setters such as International Accounting Standards Board (IASB) and Financial Accounting Standard Board (FASB) have developed standard which are less conservative in nature in an attempt to reduce conservatism in financial reporting. The principle of conservatism is no longer included in the Conceptual Framework for Financial Reporting. IASB (2010) which excluded the principle of conservatism from the conceptual framework was actually not eliminate completely. Form of

conservatism removed from the conceptual framework is a form of unconditional conservatism instead of conditional conservatism (Andre, 2013). In accounting standards, examples of practical applications of conservatism principle as an accounting tool include adopting the method of the lower of cost or net realizable value of inventory, impairment testing for the value of asset, and contingency accounting (Wang, 2013).

Beaver and Ryan (2005) divided conservatism into unconditional conservatism and conditional conservatism. Unconditional conservatism (*ex-ante* or independent news) occurs when the book value net asset is set too low because companies recognized immediately research and development costs, marketing costs (advertising) or use the accelerated allocation method (depreciation expenses with the double declining method). Unconditional conservatism has persistently earning in the long run because management does relatively consistent accounting policies. Unconditional conservatism is associated with the statement of financial position that is also called the balance sheet conservatism. Conditional conservatism (or news-dependent) arises when book value is written down under sufficiently adverse circumstances but not written up under favorable circumstances (Shroff, *et al.* 2013). Conditional conservatism is also known as earnings conservatism. Conditional conservatism is greater aggressiveness in the recognition of bad news than good news recognition and is considered as the main qualitative characteristics of financial reporting (Watts, 2003; Francis *et al.* 2004; Dechow *et al.* 2010). Conditional conservatism consist of impairment of assets (tangible fixed assets and intangible, financial instruments), accounting for inventory, and provisioning (Andre, 2013).

Beaver, *et al.* (2012) stated that conditional conservatism used by US companies and the demand for increasingly conservative accounting. In addition, Ball, *et al.* (2000; 2003) suggested that conservatism occurred in several other countries, where the level of conservatism depends on a variety of institutional factors. Overall, conservatism generally higher for US companies, which are interpreted as indirect evidence that conservatism advantageous because the US is generally considered as having the most efficient capital markets in the world. Ball *et al.* (2003) found that East Asian countries such as Hong Kong, Thailand, Singapore and Malaysia which are common law countries use conditional conservatism in financial reporting.

In Indonesia, Dewan Standar Akuntansi Keuangan – Ikatan Akuntan Indonesia (DSAK-IAI, 2012) eliminated the principle of conservatism on Framework for the Preparation and Presentation of Financial Statements and replaced with prudence consideration. Prudence as a part of the qualitative characteristics of financial statements, in which the judgment of prudence when making estimates under conditions of uncertainty, so that assets or income not otherwise too high (not exceeding the fair value) and liabilities or expenses not otherwise too low (not below the fair value). For example, the unpredictability of events and circumstances occurs, such as the collectability of doubtful receivables, estimated useful lives of plant and equipment, and a claim for warranty that may arise. However, DSAK-IAI (2012) does not allow by using prudence to establish hidden reserves or doing excessive allowance, and intentionally determine a lower income or asset and recognize a higher



liability which result in the financial statements does not neutral and unreliable.

This study is important due to most of previous studies investigate the effect of conservatism on earnings quality and stock return have done in developed economies country and assume that market is efficient (Ball *et al.* 2000; Penman and Zhang, 2002, Wang, 2013). This study which focus on evidence from Indonesia and Singapore as an emerging market will provide new insights from emerging market perspective where the level of efficiency of capital market is less than developed economies country.

The rest of the paper is organized as follows. Section two discusses the related literature and hypothesis. Section three cover methodology and data source. Section four present empirical findings and finally, section five draw the conclusion.

## 2. Related Literature and Hypothesis

Traditionally, accounting conservatism is described by the adage “anticipate no profits, but anticipate all losses” (Bliss 1924 in Watt, 2003). *Ceteris paribus*, this indicates that bad news is recognized earlier than good news in reported earnings. Basu (1997) suggested that the inconsistency conservatism in recognition criteria for profits and losses in accounting standards results in a slower earnings response to good news compared to bad news. Basu (1997) used this difference to quantify the accounting conservatism, and defined this discrepancy as the asymmetric timeliness of earnings. Asymmetric timeliness relates to when the information conveyed by an economic event or shock is recorded in periodic accounting earnings earlier if it conveys bad news and later if it conveys good news (Shroff, *et al.* 2013). Conservatism is defined as the differential verifiability required for recognition of profits versus losses (Watt, 2003). Asymmetric timeliness in news recognition is expected to manifest itself also as asymmetric persistence in earnings (Watt, 2003). Since accountants typically report the capitalized value of bad news as losses, bad news earnings is more timely but less persistent. In contrast, good news is reflected in earnings on a less timely basis, but good news earnings tends to be more persistent. Good news earnings is less timely because accountants require more verifiable information before they recognize good news. But good news earnings is more persistent than bad news earnings because the capitalized value of the good news is only partially reflected in current earnings, and after verification, is also reflected in subsequent earnings.

According Kazemi (2011), conservatism makes profit becomes more predictable so that the profit to be more qualified, and will further enhance stock returns. This contrasts with Salehi and Zareijam (2011) which showed that there was no relationship between conservatism and stock returns. By using a proxy performance of different companies, Martani and Dini (2010) showed a positive relationship between accounting conservatism and operating cash flows and cash flows of investment.

This study argues that conservatism has a very important role in determining the quality of financial information, particularly with regard to the performance of the company. Immediate recognition of the economic loss compared with the economic benefits do not guarantee high quality of the performance of the company. That is, the greater the difference in the degree of verification to recognize gains than losses, the greater conservatism. Consequently earnings downward bias due to the recognition of income (assets) accrual lower than operating cash flow. This condition result in less qualified earning. It is also in accordance with accounting setters that a negative earnings in the current period as a result of the elimination of assets and liabilities increase would turn into a positive earnings in the next period, so that the figures presented in the financial statements do not suit with the correct number. In other words, previous theories supported the opinion that conservatism positive and useful for decision-usefulness has not appropriate. Thus, this study suggested that conservatism negatively affect the performance of the company. If the company's performance deteriorates, then stock returns and operating cash flow will also decrease. This study proposes Hypothesis 1 as follows:

H1: Conservatism will negatively affect the company's performance.

The following two concepts are proposed in H1.

H1a: differential timeliness will negatively affect the company's performance.

H1b: Hidden reserve will negatively affect the company's performance.

LaFond and Watts (2008) contended that information asymmetry between the insiders and outsiders result in demand for conservatism and concluded that conservatism can reduce earnings manipulation incentives for the insiders of a corporation, decrease agency problems among stakeholders, and further reduce information asymmetry and increase corporate value. Chi, et al. (2009) supported that conservatism accounting can reduce the occurrence of information asymmetry, and thus it can be used as a corporate governance mechanism to increase corporate value and cash flow. On the other hand, Wang (2013) stated that accounting conservatism generate current earnings is too low and too high for future earnings, thereby affecting the neutrality and relevance of financial information disclosure and will further enhance the information asymmetry between insiders and outside the company. This is supported by Mashayekhi (2010), where conservatism results in fluctuating earning and is not persistent, thereby increase information asymmetry.

This study suppose that the higher information asymmetry, the higher conservatism and the lower information asymmetry, the lower conservatism. Conservatism gives a different perception. First, the higher conservatism means that financial statements are not informative, results in increasing information asymmetry and encourage investors increase the bid-ask spread as a self-protection. Second, outside investors suppose that corporations do "taking a big bath", and it negatively affects the informatively of financial statement. In other words, when the higher information asymmetry, then conservatism will reduce role in improving corporate performance. The

argument proposes that bid-ask spreads is used to measure information asymmetry would adversely affect the relationship between conservatism and corporate performance (coefficient interaction between information asymmetry and conservatism will be negative). Therefore, information asymmetry could be expected to strengthen the effect of conservatism on the company's performance. This study proposes Hypothesis 2 as follows:

H2: Information asymmetry strengthen the effect of conservatism on the company's performance.

### 3. Methodology and Data Source

#### 3.1 Measuring Performance Company's

##### 3.1.1 Stock Return

Ang (2010) states that stock return is the rate of return on investment by investors. The investors are motivated to invest in the desired instrument in the hope of obtaining an appropriate return. Investors would not be willing to invest when the expected return is not appropriate. According to Hartono (2013), return consists of a yield return (cash paid periodically to the shareholders in the form of dividends), and gain (loss) capital (the difference between the stock price at the time of purchase and the time of sale). Van Horne and Wachowicz (2008) defines return as benefits associated with ownership including cash dividends paid last year, along with appreciation the cost or capital gains realized by the end of the year.

The formula proposed in this study (Hartono 2013) as follows:

$$\text{Stock Return}_{it} = \frac{P_{it} - P_{it-1} + D_{it}}{P_{it-1}}$$

Where  $P_{it}$  represents stock price of firm  $i$  in year  $t$ ,  $P_{it-1}$  denotes stock price of firm  $i$  in year  $t-1$ ,  $D_{it}$  indicates the weighted portfolio return of firm  $i$  in year  $t$ .

##### 3.1.2 Operating cash flows

According to IAS 7 (2010), Statement of Cash Flows Operating activities are the principal revenue-producing activities of the entity and other activities that are not investing or financing activities. Cash flows from operating activities are primarily derived from the principal revenue-producing activities of the entity. Therefore, they generally result from the transactions and other events that enter into the determination of profit or loss. The amount of cash flows arising from operating activities is a key indicator of the extent to which the operations of the entity have generated sufficient cash flows to repay loans, maintain the operating capability of the entity, pay dividends and make new investments without recourse to external sources of financing. This study measures the performance' company by divided cash flows from operating activities with total assets.

## 3.2 Measuring Conservatism

### 3.2.1. Differential Timeliness (Khan and Watts Model 2009)

Previous study adopted the asymmetric timeliness of earnings model proposed by Basu (1997) as a basis for measuring the level of accounting conservatism (La Fond and Watts, 2008). The Basu model (1997) as follows:

$$X_{it}/P_{it-1} = \beta_0 + \beta_1 DR_{it} + \beta_2 R_{it} + \beta_3 (D_{it} * R_{it}) + \varepsilon_{it} \quad (1)$$

where  $X_{it}/P_{it-1}$  indicates the continuing operating income after tax for firm  $i$  at year  $t$  divided by the equity market value at the beginning of year  $t$ , with the purpose of deflating the net income or profit using market value;  $R_{it}$  represents buy and hold return which is calculated from May 1 of year  $t$  to April 30 of year  $t+1$ ; and  $DR_{it}$  is a dummy variable. When  $R_{it}$  is a negative value,  $DR = 1$ ; otherwise,  $DR = 0$ . According to Equation (1), when the market response reflects positive news (i.e.,  $R > 0$ ), the response coefficient of earnings for good news is  $\beta_2$ , and when the market response reflects bad news ( $R < 0$ ), the response coefficient of earnings for good news is  $\beta_2 + \beta_3$ .  $\beta_3$  denotes the disparity between the accounting recognition of good news compared to bad news.  $\beta_3 > 0$  if earnings conservatism exists in accounting recognition (Basu, 1997).

Khan and Watts (2009) extend model proposed by Basu (1997), by using indicator firm-year conservatism include firm size, market to-book value, and leverage ratio. This study uses Khan and Watts (2009) model with changing leverage ratio to debt equity ratio. Basu mode has limitations (Wang, 2013), where during the process of estimation, the measurement conservatism is estimated either for an industry-year using a cross-section of firms in the industry or for a firm using a time-series of firms-years. It presages that conservatism within the same year for all firms in the industry are homogeneous and the firm's operating is stationary. To resolve this problems, Khan and Watts (2009) developed firm-years conservatism measurement. Khan and Watts (2009) determines the timeliness of good news (G-score) and the incremental in accuracy of bad news (C-score) as a linear function of the specific company's characteristics each year.

The formula proposed in this study (Khan and Watts, 2009) as follows:

$$G\text{-score} = \beta_2 = \mu_1 + \mu_2 \text{Size}_{it} + \mu_3 \text{MB}_{it} + \mu_4 \text{DER}_{it} \quad (2a)$$

$$C\text{-score} = \beta_3 = \lambda_1 + \lambda_2 \text{Size}_{it} + \lambda_3 \text{MB}_{it} + \lambda_4 \text{DER}_{it}(b) \quad (2b)$$

$\beta_2$  represents the response to good news of the earnings in Equation (2a),  $\beta_3$  indicates the disparity in responses toward good and bad news for earnings in Equation (2b),  $\text{Size}_{it}$  denotes the logarithm of total assets,  $\text{MB}_{it}$  is market-to-book ratio, and  $\text{DER}_{it}$  is debt equity ratio. By substituting Equations. (2a) and (2b) into the Basu (1997) estimation model represented in Equation (1), the annual cross-section regression model is:

$$X_{it}/P_{it} = \beta_0 + \beta_1 D_{it} + R_{it} * (\mu_1 + \mu_2 \text{Size}_{it} + \mu_3 \text{MB}_{it} + \mu_4 \text{DER}_{it}) + D_{it} * R_{it} * (\lambda_1 + \lambda_2 \text{Size}_{it} + \lambda_3 \text{MB}_{it} + \lambda_4 \text{DER}_{it}) + (\delta_1 \text{Size}_{it} + \delta_2 \text{MB}_{it} + \delta_3 \text{DER}_{it} + \delta_4 D_{it} * \text{Size}_{it} + \delta_5 D_{it} * \text{MB}_{it} + \delta_6 D_{it} * \text{DER}_{it}) + \varepsilon_{it} \quad (3)$$

Equation 3 is reorganizing and obtaining the regression estimation (equation 4) as follows:

$$X_{it}/P_{it} = \beta_0 + \beta_1 D_{it} + \mu_1 R_{it} + \mu_2 (R_{it} * \text{Size}_{it}) + \mu_3 (R_{it} * \text{MB}_{it}) + \mu_4 (R_{it} * \text{DER}_{it}) + \lambda_1 (R_{it} * D_{it}) + \lambda_2 (R_{it} * D_{it} * \text{Size}_{it}) + \lambda_3 (R_{it} * D_{it} * \text{MB}_{it}) + \lambda_4 (R_{it} * D_{it} * \text{DER}_{it}) + \delta_1 \text{Size}_{it} + \delta_2 \text{MB}_{it} + \delta_3 \text{DER}_{it} + \delta_4 (D_{it} * \text{Size}_{it}) + \delta_5 (D_{it} * \text{MB}_{it}) + \delta_6 (D_{it} * \text{DER}_{it}) + \varepsilon_{it} \quad (4)$$

### 3.2.2 Hidden Reserve (Penman and Zhang, 2002)

The hidden reserve measures the effect of conservative accounting on the balance sheet. Penman and Zhang (2002) measure the C-score as the level of estimated reserves created by the conservatism,  $ER_{it}$ , relative to net operating assets:

The formula proposed in this study (Penman and Zhang, 2002) as follows:

$$C_{it} = ER_{it} / NOA_{it} \\ C_{it} = (RD_{it}^{res} + ADV_{it}^{res}) / NOA_{it}$$

Where net operating assets (NOA) is the book value of operating assets minus operating liabilities, excluding financial assets and liabilities (financing debt and assets in which the firm invests excess cash). R&D reserve ( $RD_{it}^{res}$ ) is calculated as the estimated amortized R&D assets that would have been on the balance sheet if R&D had not been expensed. Advertising reserve ( $ADV_{it}^{res}$ ) is the estimated brand assets created by advertising expenditures.

### 3.3 Measuring Information Asymmetry

Amihud and Mendelsen (1986) contended that the bid-ask spread is the difference between the bid and ask (offer) prices quoted by a dealer who makes a market in a stock and bridges the time gaps between asynchronous public buy and sell orders. The ask price reflects a price concession includes a premium for immediate buying, and the bid price reflects a price concession for immediate sale. The bid-ask spread is viewed as the price the dealer (or market-maker) demands for providing liquidity services and immediacy of execution. Glosten and Milgrom (1985) asserted that the market makers' bid-ask spreads increase with the number of informed transactions, reflecting a rise in the level of information asymmetry.

The formula proposed in this study (Callahan, *et al.* 1997) as follows:

$$Spread_{it} = \left[ \frac{\sum_{t=1}^N \frac{ask_{it} - bid_{it}}{(ask_{it} + bid_{it})/2}}{N} \right]$$

Where  $Spread_{it}$  (BAS) represents the average percentage of the bid-ask spread of stock  $i$  during year  $t$ .  $Ask_{it}$  indicates the lowest selling price caused investors agreed to sell the stock  $i$  in year  $t$ .  $Bid_{it}$  denotes the highest purchase price caused investors agreed to buy the stock  $i$  in year  $t$ .  $N$  is the sum of observations for year  $t$ .

### 3.4 The Models

The proposed model consist of model 1 and model 2 as follows:

Model 1:

$$RET_{it} = \gamma_0 + \gamma_1 KONS_{it} + \gamma_2 AI_{it} + \gamma_3 KON_{it} * AI_{it} + \gamma_4 IOS_{it} + \gamma_5 SIZE_{it} + \gamma_6 DER_{it} + \gamma_7 COUNTRY_{it} + \gamma_8 DYEARS_{it} + \varepsilon_{it}$$

Model 2:

$$CFO_{it} = \gamma_0 + \gamma_1 KONS_{it} + \gamma_2 AI_{it} + \gamma_3 KON_{it} * AI_{it} + \gamma_4 IOS_{it} + \gamma_5 SIZE_{it} + \gamma_6 DER_{it} + \gamma_7 COUNTRY_{it} + \gamma_8 DYEARS_{it} + \varepsilon_{it}$$

Where  $RET_{it}$  is Stock returns of firm  $i$  in year  $t$ .  $CFO_{it}$  is operating cash flow of firm  $i$  in year  $t$ .  $Kov_{it}$  denotes Conservatism of firm  $i$  in year  $t$  proxy by  $CSCORE$  ( $X_{it}$ ) and  $HIDRES$  ( $C_{it}$ ).  $X_{it}$  is the C-score firm  $i$  in year  $t$  (model Khan and Watts, 2009).  $C_{it}$  is the C-score hidden reserve firm  $i$  in year  $t$  (model Penman and Zhang (2002).  $AI_{it}$  represents Asymmetry information firm  $i$  in year  $t$  (bid-ask spread).  $IOS_{it}$  denotes Investment opportunity set of firm  $i$  in year  $t$ .  $SIZE_{it}$  is size firms  $i$  in year  $t$ .  $DER$  is debt equity ratio of firm  $i$  in year  $t$ .  $COUNTRY_{it}$  is dummy variable country, 1 for Indonesia; and 2 for Singapore.  $DYEARS_{it}$  is dummy variable year, 0 for the year 2008; and 1 for apart the year 2008.  $\gamma_0, \zeta_0, \eta_0 = \text{constant}$ .  $\varepsilon_{it} = \text{residual error in year } t$ .

### 3.5 Data and Sample Selection

Population in this study are 198 public manufacturing firms listed on the Indonesian Stock Exchange (BEI) and 275 public manufacturing firms listed on Singapore International Monetary Exchange (SIMEX) for the period 2013. Samples is chosen based on the purposive sampling with the following criteria: (a) Firms listed on the Indonesian Stock Exchange and Singapore International Monetary Exchange during the study (2004-2013); and (b) Firms have completed data.

Based on the above criteria, the company have not been listed since 2004 in Indonesia Stock Exchange equal to 69 and in Singapore International Monetary Exchange equal to 106 companies. So the rest of the company which can be used as a sample of 298 companies. This study uses financial statement data during the period 2004 till 2013. Variables stock returns and conservatism requires measurement of the past time period ( $t-1$ ) and the future ( $t+1$ ), so that the sample period used in this study was the period 2005

to 2012. The number of firm-year observations as much as 2,384 observations. The data in this study obtained from OSIRIS database; Indonesian Capital Market Directory (ICMD), Singapore Exchange (SGX) and Financial statements report.

## 4 Empirical Results

### 4.1 Descriptive Statistics

Table 1 shows the descriptive of the first model. The mean for RET, CSCORE, HIDRES were 0.208, 0.2439 and -1.558, respectively. The bid-ask spread was 0.2007. The mean for DER, MB, SIZE, COUNTRY and DYEARS were 1.3183, 1.3366, 8.9301, 1.5671, and 0.875, respectively. The interaction variables for CSCORE\*BAS and HIDRES\*BAS were approximately -0.0725, and -0.2285, respectively.

Table 1. Descriptive Statistics of the First Model

Variable	N	Minimum	Maximum	Mean	Std. Deviation
Dependent:					
RET	2384	-1	12.41	0.208	0.87458
Independent:					
CSCORE	2384	-16.74	3.07	0.2439	0.98858
HIDRES	2366	-9.21	9.75	-1.558	2.4547
Information Asymmetry					
BAS	2384	-1.96	2	0.2007	0.30701
Control Variables:					
DER	2384	-201.49	237.64	1.3183	8.32491
MB	2384	-66.39	45.3	1.3366	3.40521
SIZE	2384	7.34	11.61	8.9301	0.6492
COUNTRY	2384	1	2	1.5671	0.49558
DYEARS	2384	0	1	0.875	0.33079
Interaction variable:					
CSCORE*BAS	2384	-9.55	4.72	-0.0725	0.32436
HIDRES*BAS	2377	-10.1	9.1	-0.2285	0.96131

Notes: RET is stock return, CSCORE is Khan and Watts (2009) measure of conservatism, HIDRES is Penman and Zhang (2002) measure of conservatism, DER symbolizes the debt equity ratio, MB is the firm market-to-book ratio, SIZE denotes the logarithmic value for the total asset of the corporation, COUNTRY = 1 for Indonesian companies and 2 for Singapore companies, DYEARS = 1 for the year of 2004-2007 & 2009-2013, and 0 for the year of 2008.

Table 2 shows the descriptive of the second model. The mean for CFO, CSCORE, HIDRES were 0.052, 0.2439 and -1.558, respectively. The bid-ask spread was 0.2007. The mean for DER, MB, SIZE, COUNTRY and DYEARS were 1.3183, 1.3366, 8.9301, 1.5671, and 0.875, respectively. The interaction variables for CSCORE\*BAS and HIDRES\*BAS were approximately -0.0725, and -0.2285, respectively.

Table 2. Descriptive Statistics of the Second Model

Variable	N	Minimum	Maximum	Mean	Std. Deviation
Dependent:					
CFO	2384	-2.32	3.87	0.052	0.17392
Independent:					
CSCORE	2384	-16.74	3.07	0.2439	0.98858
HIDRES	2366	-9.21	9.75	-1.558	2.4547
Information Asymmetry					
BAS	2384	-1.96	2	0.2007	0.30701
Control Variables:					
DER	2384	-201.49	237.64	1.3183	8.32491
MB	2384	-66.39	45.3	1.3366	3.40521
SIZE	2384	7.34	11.61	8.9301	0.6492
COUNTRY	2384	1	2	1.5671	0.49558
DYEARS	2384	0	1	0.875	0.33079
Interaction variable:					
CSCORE*BAS	2384	-9.55	4.72	-0.0725	0.32436
HIDRES*BAS	2377	-10.1	9.1	-0.2285	0.96131

Notes: RET is stock return, CSCORE is Khan and Watts (2009) measure of conservatism, HIDRES is Penman and Zhang (2002) measure of conservatism, DER symbolizes the debt equity ratio, MB is the firm market-to-book ratio, SIZE denotes the logarithmic value for the total asset of the corporation, COUNTRY = 1 for Indonesian companies and 2 for Singapore companies, DYEARS = 1 for the year of 2004-2007 & 2009-2013, and 0 for the year of 2008.

#### 4.2 Hypothesis Analysis

The first model examines whether there is a negative effect of conservatism on the company's performance (which measured by stock return) and investigates whether the information asymmetry strengthens the influence of conservatism on the performance company. The empirical results of model 1 are listed in Table 3. Table 3 indicates data regarding H1 and H2 using stock returns as dependent variable.

Table 3. Regression Model 1 Results

$$RET_{it} = \gamma_0 + \gamma_1 KONS_{it} + \gamma_2 AI_{it} + \gamma_3 KONS_{it} * AI_{it} + \gamma_4 IOS_{it} + \gamma_5 SIZE_{it} + \gamma_6 DER_{it} + \gamma_7 COUNTRY + \gamma_8 DYEARS + \epsilon_{it}$$



	Coefficient	t-stat	Sig.
(Constant)	.106	.599	0.549
CSCORE	-.611	-45.510	.000***
HIDRES	-.014	-2.098	0.036**
BAS	.762	17.273	.000***
DER	-.001	-.414	0.679
MB	.015	3.831	.000***
SIZE	-.016	-.848	0.397
NEG	-.080	-2.761	0.006**
DTHN	.329	9.027	.000***
CSCORE*BAS	-.455	-10.768	.000***
HIDRES*BAS	-.023	-1.515	0.130
F-s statistic	302.464		
Sig. F-s statistic	.000***		
Adjusted R-squared	.560		
a. Dependent Variable: RET			

Notes: RET is stock return, CSCORE is Khan and Watts (2009) measure of conservatism, HIDRES (hidden reserve) is Penman and Zhang (2002) measure of conservatism, DER symbolizes the debt equity ratio, MB is the firm market-to-book ratio, SIZE denotes the logarithmic value for the total asset of the corporation, COUNTRY = 1 for Indonesian companies and 2 for Singapore companies, DYEARS = 1 for the year of 2004-2007 & 2009-2013, and 0 for the year of 2008.

Based on Table 3, it can be figured that both of the measurement of conservatism such as CSCORE and HIDRES have a negative coefficient to stock returns. (a) The coefficient CSCORE is -0.611 (negative), significant at 1% level (t-statistic -45.510; sig. 0.000). It means that as the conservatism which measured by differential timeliness is negatively affect stock returns. Therefore, hypothesis 1a is accepted. (b) The coefficient of hidden reserve (HIDRES) is -0.014 (negative), significant at the 5% level (t-statistic -2.098; sig. 0.036), it means that the conservatism which is quantified by hidden reserve is negatively affect the company's performance (stock returns). Therefore, hypothesis 1b is accepted.

This study also finds that DER and SIZE have a negative coefficient, each of -0.001 and -0.01, and t-statistic is less than 1.96, equal to -0.414 and -0.848 respectively and not significant at 0.679 and 0.130. The other word, debt to equity ratio does not influence stock return, however size influences negatively significant on stock return. The variables of bid-ask spread (BAS) and market-to-book ratio (MB) positively significant influence stock return.

In regarding with the acceptance both of hypothesis 1a and hypothesis 1b, it can be concluded that conservatism is negatively affect the company's performance (stock returns), so hypothesis 1 is accepted. This negative coefficient indicates the conservatism results in fluctuating earning, thereby increase information asymmetry and deteriorates the company's performance, then decreases stock returns. This result supports the findings of and Mashayekhi (2010) and Wang (2013) that accounting conservatism generates the lower of current earnings and the higher future earnings, thereby affects

the neutrality and relevance of financial information disclosure and further enhances information asymmetry between insiders and outside the company. However this result is not consistent with Salehi and Zareijam (2011), in which there was not relationship between conservatism and stock returns.

Table 3 also shows that the measurement of interaction between conservatism and information asymmetry such as CSCORE\*BAS has a negative coefficient (-0.455) to stock returns and significant at 1% level (t-statistic -10.768; sig. 0.000). It indicates that the interaction of conservatism and information asymmetry which is quantified by CSCORE\*BAS is strengthen the effect of conservatism on the company's performance (stock returns). Thus, it can be concluded that information asymmetry strengthen the effect of conservatism on the company's performance and hypothesis 2 (H2) is accepted. This result supports the finding of Wang (2013), in which when the higher information asymmetry, then conservatism will reduce role in improving corporate performance, and will encourage investors increase the bid-ask spread as a self-protection.

The other hand, the interaction between conservatism and information asymmetry such as HIDRES\*BAS have a negative coefficient (-0.023) to stock returns and significant at the 5% level (sig. 0.130), and t-statistic is -1.515 less than 1.96. Therefore, the information asymmetry by quantifying hidden reserve strengthens the influence of conservatism on the company's performance (stock return). It indicates that management does not reserve inventory (LIFO), research and development and advertising. Management may expense directly the expenditure of R&D and advertising.

The second model examines whether there is a negative effect of conservatism on the performance company (which measured by operating cash flows) and investigated whether the information asymmetry strengthens the influence of conservatism on cash flows from operations. The empirical results of model 2 are listed in Table 4. Table 4 indicates data regarding H1 and H2 using operating cash flows as dependent variable.

Table 4. Regression Model 2 Results

$$CFO_{it} = \delta_0 + \delta_1 KONS_{it} + \delta_2 AI + \delta_3 KON_{it} * AI_{it} + \delta_4 IOS_{it} + \delta_5 SIZE_{it} + \delta_6 DER_{it} + \delta_7 COUNTRY + \delta_8 DYEARS + \epsilon_t$$

	Coefficient	t-stat	Sig.
(Constant)	.078	1.508	.132
CSCORE	-.005	-.985	.325
HIDRES	-.005	-1.886	.059
BAS	-.001	-.122	.903
DER	-.001	-2.017	.044
MB	.004	3.728	.000
SIZE	-2.869E-05	-.005	.996
NEG	-.018	-2.427	.015
DTHN	-.004	-.406	.684
CSCORE*BAS	-.041	-1.873	.061
HIDRES*BAS	-.009	-1.351	.177
F-statistic	2.694		
Sig. -statistic	.003**		
Adjusted R-squared	.007		
b. Dependent Variable: CFO			

Notes: CFO is operating cash flows, CSCORE is Khan and Watts (2009) measure of conservatism, HIDRES (hidden reserve) is Penman and Zhang (2002) measure of conservatism, DER symbolizes the debt equity ratio, MB is the firm market-to-book ratio, SIZE denotes the logarithmic value for the total asset of the corporation, COUNTRY = 1 for Indonesian companies and 2 for Singapore companies, DYEARS = 1 for the year of 2004-2007 & 2009-2013, and 0 for the year of 2008.

Table 4 indicates that both of the measurement of conservatism such as CSCORE and HIDRES have a negative coefficient to operating cash flows. The coefficient CSCORE is -0.005 (negative), t-statistic -0.985 and sig. 0.325. It means that as the conservatism which measured by differential timeliness (CSCORE) does not affect operating cash flow. Thus, there is no relationship between the conservatism by quantifying CSCORE and operating cash flow. (b) The coefficient of hidden reserve (HIDRES) is -0.005 (negative), significant at the 10% level (sig. 0.059), and t-statistic -1.886 < 1.96. It indicates that the conservatism which is quantified by hidden reserve (HIDRES) affects operating cash flows. Thus, the conservatism by quantifying HIDRES affect negatively significant on operating cash flow. Therefore, hypothesis 1a (H1a) is accepted. This result does not supports the findings of Martani and Dini (2010) that shows a positive relationship between accounting conservatism and operating cash flows and cash flows of investment.

Table 4 also shows that both of the measurement of interaction between conservatism and information asymmetry such as CSCORE\*BAS and HIDRES\*BAS have a positive coefficient to operating cash flows. (a) The coefficient CSCORE\*BAS is -0.041 (positive), t-statistic -1.873, sig. 0.061. (b) The coefficient of HIDRES\*BAS is -0.009 (positive), t-statistic -1,351, sig. 0.177). It indicates that the interaction of conservatism and information asymmetry which is quantified by CSCORE\*BAS and HIDRES\*BAS moderates the influence of conservatism on operating cash flows. It can be concluded that information asymmetry strengthens the effect of conservatism on operating cash flows. Therefore, hypothesis 2 is accepted.

## 5 Conclusion

The purpose of this study is to examine the influence of accounting conservatism on the company's performance and to test whether information asymmetry strengthens the effect of accounting conservatism on the company's performance. This study finds that accounting conservatism will negatively affect stock return and operating cash flows. This study also finds that information asymmetry strengthens the effect of accounting conservatism on stock return and operating cash flows.

## References

- Amihud, Y. and Mendelsen, H. (1986). Liquidity and Stock Returns. *Financial Analysts Journal*. May-June. Pp 43- 48.
- Andre, P., Filip, A. and Paugam, L. (2013). *Impact of Mandatory IFRS Adoption on Conditional Conservatism in Europe*, ESSEC Working paper. Document de Recherche ESSEC/Centre de recherche de l'ESSEC. ISSN: 1291-9616.
- Ang, R. (2010). *Buku Pintar Pasar Modal Indonesia*, Edisi 7, Media Soft Indonesia, Jakarta.
- Ball, R., Kothari, S.P and Robin, A. (2000). The Effect of International Institutional Factors on Properties of Accounting Earnings. *Journal of Accounting and Economics* 29, pp. 1-51.
- Ball, R., Robin, A. and Wu, J.S. (2003). Incentives versus Standards: Properties of Accounting Income in Four East Asian Countries. *Journal of Accounting and Economics* 36, pp. 235-270.
- Basu, S. 1997. The Conservatism Principle and the Asymmetric Timeliness of Earnings. *Journal of Accounting and Economics*, 24 (December), pp. 3-37.
- Beaver, W.H., and Ryan, S.G. (2005). Conditional and Unconditional Conservatism: Concepts and Modeling. *Review of Accounting Studies*, 10 (2/3), pp 269-309.
- Beaver, W.H., Landsman, W.R. dan Owens, E.L. (2012). Asymmetry in Earnings Timeliness and Persistence: a Simultaneous Equations Approach. *Review of Accounting Studies* 17, pp. 781-806.
- Callahan, C. M., Lee, C. M. C., and Yohn, T. L. (1997). Accounting information and Bid Ask Spreads. *Accounting Horizons*, Vol. 11, No. 4, pp. 50-60.
- Chi, W., Liu, C., and Wang, T. (2009). What Affects Accounting Conservatism: A Corporate Governance Perspective. *Journal of Contemporary Accounting and Economic*, 5, pp. 47-59.

Dechow, P.M., Ge, W. and Schrand, C.M. (2010). Understanding Earnings Quality: A Review of The Proxies, Their Determinants and Their Consequences, *Journal of Accounting and Economics*, 50(2-3), pp. 344-401.

Dewan Standar Akuntansi Keuangan Ikatan Akuntan Indonesia (2012). *Standar Akuntansi Keuangan, Kerangka Dasar Penyusunan Dan Penyajian Laporan Keuangan*.

Francis, J., LaFond, R., Olsson, P.M. and Schipper, K. (2004). Costs of Equity and Earnings Attributes. *The Accounting Review*, 79(4), pp 967–1010.

Glosten, L.R. and Milgrom, P.R. (1985). Bid, Ask and Transaction Prices in A Specialist Market With Heterogeneously Informed Traders. *Journal of Financial Economics* 14 (1985) pp. 71-100.

Hartono, J. (2013). *Teori Portofolio dan Analisis Investasi*, Edisi Kedelapan, BPF, Yogyakarta.

International Accounting Standard Board (2010), *International Accounting Standard 7 Statement of Cash flows*.

International Accounting Standard Board (2010), *Conceptual Framework for Financial Reporting 2010*.

Kazemi, H, Hammati, H and Faridvand, R (2011), Investigating The Relationship Between Conservatism and Earnings Attribute, *World Applied Science Journal*, Vol. 12, (9), pp. 1385-1396.

Khan, M., and Watts, R. L. (2009). Estimation and Empirical Properties of a Firm-Year Measure of Accounting Conservatism. *Journal of Accounting and Economics*, 48, pp. 132-150.

LaFond, R., and Watts, R. L. (2008). The Information Role of Conservatism. *The Accounting Review*, 83, pp.447-478.

Mashayekhi, B., Abadi, M.M. and Reza, H.S., (2010). The Effect of Accounting Conservatism on Earning Persistence. *Journal of Accounting Review*, pp. 107-124.

Martani, D. and Dini, N. (2010). The Influence Of Operating Cash Flow And Investment Cash Flow To The Accounting Conservatism Measurement. *Chinese Business Review*, Vol. 9, No.6 (Serial No.84), pp. 1-6.

Penman, S., and Zhang, X., (2002). Accounting conservatism, the quality of earnings, and stock returns. *The Accounting Review* 77, 237-264.

Salehi, M. and Zareijam, A. (2011). A Study of the Effect of Conservatism on Stock Return: Evidence of Iranian Chemical Industry. *Journal of Asian Business Strategy*, Vol. 1(3): pp. 31-44.

Shroff, P.K., Venkataraman, R., Zhang, S. (2013). The Conservatism Principle and the Asymmetric Timeliness of Earning: An Event-Based Approach. *Contemporary Accounting Research*, Vol 30 No. 1, pp 215-241.

Van Horne, J.C. and Wachowicz, J.M. (2008). *Fundamental of Finance Management*. Twelfth Edition, Financial Times Prentice Hall.

Wang, J.L. (2013). Accounting Conservatism and Information Asymmetry: Evidence from Taiwan. *International Business Research*; Vol. 6, No. 7. pp. 32-43.

Watts, R.L. (2003). Conservatism in Accounting Part I: Explanations and Implications. *Accounting Horizons*, Vol. 17, No. 3, pp. 207-221.

## **The Impact of Accounting Conservatism on Corporate Equity Valuation Moderated by Good Corporate Governance (An Empirical Study on LQ45 Companies for Period 2010-2012)**

<sup>1</sup>Ahalik, <sup>2</sup>Bayu Pasupati

<sup>1</sup>Accounting Department – Kalbis Institute, Jakarta, *ahalik\_ui@yahoo.com*, +628161691121

<sup>2</sup>Accounting Department - President University, Cikarang, *bayupasupati7@gmail.com*, +628111756121

### **Abstract**

The objective of this study is to determine the influence of accounting conservatism on the assessment of corporate equity valuation and the ability of Good Corporate Governance (GCG) in interact the effect of accounting conservatism to the corporate value. Sample in this research is companies that consistently fall withing LQ45 Index for period 2010-2012. Number of sample is 29 companies with 87 observations. The accounting conservatism proxy by the difference between net income and operating cash flow divided by average total assets (ACC\_CON). The assessment of corporate equity valuation proxy by market-to-book ratio. The mechanism of Corporate Governance is measured using managerial ownership, proportion of independent board of commissioners and number of audit committee.

The results showed that accounting conservatism giving significant positive influence to corporate equity valuation. All of the mechanism of Good Corporate Governance (GCG) used in this research, managerial ownership, proportion of independent board of commissioners and audit committee, were moderating variable that interact relation between accounting conservatism with corporate equity valuation.

Since this research only shows 36% of dependent variable is explained by independent variables, the next researcher can search other independent variables that may affect equity valuation like economic condition, market perception, company or world event, human psychology and so on. Next researcher also may use other proxy of accounting conservatism.

**Key words:** *conservatism instrument variable, market-to-book ratio, corporate governance mechanism.*

## **1. Introduction**

### **1.1. Background**

Suwardjono (2005) stated that the prudence action is applied by immediately recognizing expenses or losses that possibly happen, but not immediately recognizes revenue or gains that will be received. This actions is called accounting conservatism. In traditional adage, it is "anticipate no profit and recognize all losses."Conservatism concept or pessimism obliges expenses or losses to be immediately recognized while the recognition of revenue and gains will be recognize after there is realization certainty.

Based on Ball et al. 2000; Watts 2003a; Watts 2003b; Ball and Shivakumar 2005, accounting conservatism fulfills an important role in providing high-quality information for investors. Panicked investors caused by financial crisis will withdraw from the stock market entirely or move their money to what they perceive as high-quality firm. Based on Basu (1997), accounting conservatism mitigates managerial opportunism by requiring higher degree of verification to recognize good news as gains than to recognize bad news as losses.

Accounting conservatism becomes concern of many parties. Based on the research done by Fala (2007), accounting conservatism influences corporate equity valuation that moderated by Good Corporate Governance (GCG). GCG is a system that regulates and controls corporation to create higher added value for stakeholders. Besides, shareholders can get information based on what they want so that the principle of corporate governance can enhance the quality of corporate financial statement that will eventually increase trust between both parties to avoid continuous conflicts.

Corporate governance plays an important role in the implementation of conservatism. Governance is the set of mechanism in place (1) to ensure that the assets of the firm are used efficiently and (2) to prevent the inappropriate distribution of the assets to managers or to other parties at the expense of the rest of stakeholders. Thus, strong corporate governance results in better monitoring of management, produces more timely accounting information, accelerates the recognition of bad news to provide board-of directors with early-warning signals to investigate the reasons for the bad news and reduces the likelihood of incurring litigations costs. All of this outcomes also resulted by implementing accounting conservatism. The research done by Lara, Osma and Penalva (2005) found that firm with strong corporate governance exhibit a higher degree of accounting conservatism. Thus, the researcher used good corporate governance as moderator variables since its existence strengthen exhibits a higher degree of accounting conservatism that influences corporate equity valuation.

Therefore, when a corporation applied accounting conservatism with the practice of GCG, like percentage of managerial ownership, proportion of independent commissioners and audit committee will influence corporate equity valuation. The higher the percentage of managerial ownership, proportion of independent commissioners and number of audit committee, the higher the monitoring and corporation performance that will increase corporate equity valuation.

### **1.2. Statement of Problems**

Based on the explanation on research background so the problem statements are as follow :

1. Does accounting conservatism have positive influence on corporate equity valuation?
2. Does percentage of managerial ownership have positive influence on relationship of accounting conservatism towards corporate equity valuation?
3. Does proportion of independent commissioners have positive influence on the relationship of accounting conservatism towards corporate equity valuation?
4. Does number of audit committee have positive influence on the relationship of accounting conservatism towards corporate equity valuation?

### **1.3. Research Benefits**

This research can give suggestion for investors in investing their funds in capital market related to accounting conservatism practice and corporate equity valuation. Then, for companies, this research can be used as source of information for implementation of company's policy related to accounting conservatism and implementation of good corporate governance. Last but not least, this research can give a reference for next researcher in the future.



## **2. Literature Review and Hypotheses Development**

### **2.1. Agency Theory**

Agency theory states that if there is a separation between the owner as principal dan managers as agents who run the company, the agency problems will exist since each side will always try to maximize utility function (Jensen & Meckling, 1976). To minimize these agency problems, so contracts are made in company either between management and employees, However, the conflict can not be eliminated completely by using contracts because costs for complete contracts is very expensive, and impossible. (Fama dan Jensen, 1983; Hart, 1995). Thus, in the absence of contract in which contract is not made perfectly, corporate governance mechanism plays an important role in mitigating those conflicts.

Conservatism is one of important characteristics in companies' accounting systems that can help board of directors in reducing agency cost and increase the quality of information in financial statements and at the end increase the value of companies and their shares price. (Watts, 2003, 2006 dalam Ahmed dan Duellman, 2007).

### **2.2. Signalling Theory**

Signalling theory stressed the importance of information released by the company to an investment decision on the parties outside the company. Information is an essential element for investors and business people because the information is essentially presenting information, records or state picture for past, current and future conditions for the going concern of a company and how the market effect. Complete, relevant, accurate and timely information is required by investors in the capital market as an analytical tool to make investment decisions.

According Jogiyanto (2000: 392), information published as an announcement will give a signal to investors in making investment decisions. If the notice contains a positive value, it is expected that the market will react when the announcement was welcomed by the market. At the time the information was announced and all market participants have received such information, market participants must first interpret and analyze such information as the signal is good (good news) or poor signal (bad news). If the announcement of such information as a good signal for investors, then there is a change in the volume of stock trading.

### **2.3. Accounting Conservatism**

Penman and Zhang (2002) and Wolk et al (2001) suggest that conservative accounting is not only related to the choice of accounting methods, but also estimate that is often applied in relation to accrual accounting. Basu (1997) mentions that conservatism is an accounting practice that reduces profits (and lower net assets) in the face of bad news, but do not increase profits (and increase net asset value) when responding to good news. Seen from the point of view of earnings management, this definition looks similar but the difference is in the word "do not increase profits (and increase net asset value) when responding to good news."

According to Watts (2003b) an explanation of the earnings management literature seems compatible with conservatism based on the following reasons: (1) establish reserves understate net assets, (2) remove the negative stock returns, potentially giving relationships earnings / stock return is asymmetric, (3 ) initial losses will be temporary, followed by higher earnings are still generated by the use of reserves.

### **2.4. Accounting Conservatism and Equity Valuation**

Based on Basu (1997), accounting conservatism is tendency to did higher verification to recognize gains (good news in earnings) compare to when recognizing loss (bad news in earnings). Accounting conservatism can reduces opportunistic managers that tend to benefit themselves than act for the welfare of shareholders. Companies that implement accounting conservatism is a positive signal from management to investors that earnings with good quality is produced, not overstate. With efficient market

assumptions, investors can receive this signal and corrects undervalued equity by valuing the company's equity at a higher price.

Research conducted by Fala (2007) states that accounting conservatism positive effect on the company's equity valuation. This result also supported by Pranama (2008) that proved accounting conservatism has positive significant influence on equity valuation. Then the hypotheses is :

**H<sub>1</sub>: Accounting conservatism has positive significant influence on equity valuation.**

## **2.5. Managerial Ownership and the Relationship between Accounting Conservatism and Equity Valuation**

Jensen & Meckling (1976) established a theory which states that stock ownership by management will reduce the agency problem because the more shares held by the management of the stronger their motivation to work to increase companies shares price. Based on the classic agency theory, the greater ownership by inside directors (affiliated commissioner / commissioner except independent commissioners) will bring to goal congruence between management and shareholders. However, on the other side as owners, insider directors can use voting power to do expropriation towards companies.

In the context of conservatism, ownership by inside directors and management has two different views. Ownership by inside directors and the management can act as a function of monitoring the financial reporting process, and become the driving factors of expropriation against minority shareholders. If inside directors do monitoring and management function properly, then it signals financial reporting information that has high quality so that they will requires the use of a higher principle of conservatism as well. However, if ownership drive expropriation against the companies, then they will be more inclined to use a more liberal accounting principles (more aggressive). So, the higher managerial ownership, the higher monitoring and will influence the relationship between accounting conservatism and equity valuation. Thus, the hypotheses is :

**H<sub>2a</sub> : Managerial ownership has positive influence on the relationship between accounting conservatism and equity valuation.**

## **2.6. Proportion of Independent Commissioners and the Relationship between Accounting Conservatism and Equity Valuation**

While Ball (2001) which states that conservatism will facilitate the implementation of governance through its role as a monitoring function to the investment policy. With faster on recognition of losses, accounting conservatism helps managers to identify projects which have a negative NPV investment that has poor performance. Conservatism will also limit the losses that may resulted from bad performance of investment so it will increase the equity valuation (Ahmed and Duellman, 2007).

The argument above shows that conservatism is a useful tool for board of directors (especially outside directors) in carrying out their functions and decisions as decision maker to monitor management. Investors are willing to give more premium to the company because of service and control performed commissioner, the ability to monitor financial statements also increased. Research done by Fala (2007) also found that proportion of independent commissioners as one of mechanism as good corporate governance was moderating variables that interact the relationship between accounting conservatism and equity valuation. Thus, the hypothesis is:

**H<sub>2b</sub> : Proportion of independent commissioners has positive influence to the relationship between accounting conservatism and equity valuation.**

## 2.7. Audit Committee and the Relationship between Accounting Conservatism and Equity Valuation

Audit committee to assist the board of commissioners komisairs to ensure that financial statements presented fairly in accordance with generally accepted accounting principles, internal control executed, internal audit conducted in accordance with applicable auditing standards, and follow-up audit findings are implemented by management. With the audit committee of a company, the company's financial reporting processed is monitored. The audit committee ensure that companies apply the principles of financial accounting will produce accurate and good quality of information. . Xie, Davidson & Dadalt (2003) found that audit committee activity is important factor in constraining the propensity of managers to engage in earning management. Company that has audit committee will make shareholders feel safe since it reduces the manipulation done by managers. The shareholders will pay more for the equity for this safe feeling. Thus the hypotheses in this research is:

**H<sub>2c</sub> : Number of audit committee positively influence relationship between accounting conservatism and equity valuation.**

## 3. Research Method

### 3.1. Source of Data, Population and Sample

Population in this research are companies listed in Indonesia Stock Exchange during 2010 – 2012. Sample used in this research is companies that fall within LQ45 Index since LQ45 Index consists of liquid companies and actively traded in Indonesia Stock Exchange thus it has high market capitalization. The sampling method used is purposive sampling that take sample based on some criteria. The criteria are as follow:

1. Companies that fall within LQ45 Index consistently during 2010-2012.
2. Companies that publish annual report during 2010-2012.

### 3.2. Variable Operationalization

#### 3.2.1. Dependent Variable

This research used price to book ratio as proxy for equity valuation (Y). Beaver and Ryan (2000) in Watts (2003b) used price to book ratio that reflects market value relatively to equity valuation. This ratio gives assessment of companies' market shares. This ratio reflects point-of-view of investors over companies as a whole (Walsh,2003). Based on Fala (2007), price-to-book ratio shows market reaction of positive signal from companies that implement accounting conservatism in financial statements. The formula of price to book ratio as proxy of equity valuation (PBV) is as follows :

$$PBV = \frac{\text{Outstanding Shares} \times \text{Closing Price (QIV)}}{\text{Total Equity}}$$

#### 3.2.2. Independent Variable

In this research, the independent variable are :

1. Accounting Conservatism (ACC\_CON)  
Based on the model used by Givoly and Hayn (2000) in Ahmed and Duellman (2007), accounting conservatism can be measured by formula as follows :

$$ACC\_CON = \frac{NI - CF}{ATA}$$

Where :

ACC\_CON = level of accounting conservatism  
 NI = Income before extraordinary items  
 CF = Cash Flow from Operations plus depreciation expenses  
 ATA = Average of Total Assets

2. Managerial Ownership (MO)  
 Managerial ownership is shares ownership by directors, management, commissioners and every stakeholders that directly involved in economic decision making (Jensen dan Meckling, 1976).

$$MO = \frac{\text{Number of Shares Owned by Management}}{\text{Total of Companies' Shares}} \times 100\%$$

3. Proportion of Independent Commissioners (Prop)

Based on decision by Board of Directors of Indonesia Stock Exchange, Jakarta No. Kep-339./BEJ/07-2001 item C about board governance that consists of independent commissioners that do not perform executive tasks and regarding board governance that consists of Independent Commissioners, Audit Committee, and Corporate Secretary, to achieve good corporate governance, number of independent commissioners must be at least 30% from total numbers of board of commissioners. Below are the formula to measure proportion of independent commissioners (Prop).

$$Prop = \frac{\text{Number of Independent Commissioners}}{\text{Total Members of Commissioners}} \times 100\%$$

4. Audit Committee (AC)  
 Members of audit committee is appointed from member of board of commissioners that do not perform executive tasks and consists of at least three independent members. Audit committee held meeting three until four times yearly to implement its obligation and responsibility. Audit committee give professional opinion to board of commissioners to increase work quality and reduce deviation of company's governance.

AC = Number of Audit Committee's member

### 3.3. Analysis and Hypotheses Testing

This research uses multiple regression analysis. Before multiple regression analysis is done, descriptive statistic and classic assumption test must be conducted to ensure that the data is normally distributed. Below is the regression model :

$$PBV = a + \beta_1 ACC\_CON + \beta_2 MO + \beta_3 Prop + \beta_4 AC + \beta_5 MO.ACC\_CON + \beta_6 Prop.ACC\_CON + \beta_7 AC.ACC\_CON + e$$

Where:

Y	= Equity Valuation
a	= constanta
$\beta$	= regression coefficient
ACC_CON	= Accounting Conservatism
MO	= Managerial Ownership
Prop	= Proportion of Independent Commissioners
AC	= Audit Committee
MO.ACC_CON	= Interaction between Conservatism and Managerial Ownership

Prop.ACC\_CON = Interaction between Conservatism and Proportion of Independent Commissioners  
AC.ACC\_CON = Interaction between Conservatism and Audit Committee  
e = error

The researcher determines  $H_0$  and  $H_a$  as follow :

$H_0$  : Independent variable (X) has no influence on dependent variable (Y)

$H_a$  : Independent variables (X) influence dependent variable (Y)

With level of significance, 5 %, the criteria for this test are as follow:

- 1) If significance value  $t > 5\%$ , so hypotheses is rejected, means there is no impact between independent variable towards dependent variable.
- 2) If significance value  $t > 5\%$ , so hypotheses is rejected, means there is impact between independent variable towards dependent variable.

Below are the summary of how hypotheses is accepted or rejected :

$H_1$  is accepted if sig.t on  $b_1 < 0.05$  with positive  $\beta$

$H_{2a}$  is accepted if sig.t on  $b_5 < 0.05$  with positive  $\beta$

$H_{2b}$  is accepted if sig.t on  $b_6 < 0.05$  with positive  $\beta$

$H_{2c}$  is accepted if sig.t on  $b_7 < 0.05$  with positive  $\beta$

## 4. Analysis and Interpretation

### 4.1. Accounting Conservatism and Equity Valuation

Based on Table 4.1. Descriptive Statistic, Accounting Conservatism (ACC\_CON) has mean -0.11837. It means that samples in this research are conservative. Table 4.2 shows that significance value  $0.039 < 0.05$  with regression coefficient of 9.286. Since the significance value  $0.039 < 0.05$ , hypothesis ( $H_1$ ) is accepted. Thus, Accounting Conservatism has positive significant influence on Equity Valuation (PBV). Companies that implement accounting conservatism is positive signal from management to investors that earning reported has good quality, not overstated. With efficient market assumption, investors can see this positive signal and revise the undervaluation of equity by valuing the equity with higher price. This research is supported and consistent with the research done by Amalia (2007) and Pranama (2008) that also found that accounting conservatism has positive influence on equity valuation.

### 4.2. Managerial Ownership and the Relationship Between Accounting Conservatism and Equity Valuation

To test second hypotheses,  $H_{2a}$ , the level of significance on Table 4.2 of  $0.026 < 0.05$  with regression coefficient 25.586 that means hypotheses is accepted. Thus, managerial ownership has positive influence on relationship between accounting conservatism and equity valuation. In accounting conservatism concept, ownership by inside directors and management has two different point of view. Managerial ownership has monitoring function in financial reporting and supporting factor of expropriation over minority shareholders. If inside director or management perform monitoring function well, so it signals information in financial statements has high quality so that they will ask higher implementation of accounting conservatism. But, if managerial ownership encourages expropriation towards companies, they tend to use more aggressive accounting method. Thus, the higher managerial ownership, the higher monitoring process so that it will influence the relationship between accounting conservatism and equity valuation. This result is agree with the research conducted by Jensen & Mecling (1976).

### 4.3. Proportion of Independent Commissioners and the Relationship Between Accounting Conservatism and Equity Valuation

Accounting conservatism is a useful tool for board of directors (especially outside directors) in performing their function as decision maker and as party that monitors

management. Regression analysis and T-Test show that positive regression coefficient of proportion of independent board of commissioners that influence the relationship between accounting conservatism and equity valuation (Prop.ACC\_CON),  $\beta_6$  of 167.137 with  $p$ -value < 0.05 as level of significance determined by the researcher shows that  $H_{2b}$  is accepted. So the characteristic of board of directors as one of mechanism of corporate governance will have positive relationship with accounting conservatism. Among all good corporate governance mechanism, proportion of independent board of commissioners (Prop.ACC\_CON) has the most significant influence on the relationship between accounting conservatism (ACC\_CON) and equity valuation (PBV). Investors are willing to give premium to companies because of service and control performed by either board of commissioners or board of directors. The ability to monitor the financial statements also increase.

The result of this research is also supported previous research findings by Fala (2007) that stated proportion of independent commissioners as one of mechanism as good corporate governance was moderating variables that interact the relationship between accounting conservatism and equity valuation.

#### **4.4. Audit Committee and the Relationship between Accounting Conservatism and Equity Valuation**

Audit committee has task to help board of commissioners to ensure that financial statements are presented fairly based on the accounting standards, to ensure that internal control is well implemented and based on audit standards, and to ensure audit findings is implemented by management. Hypotheses  $H_{2b}$  is accepted with positive coefficient of regression of 13.745 ( $\beta_7$ ) and  $p$ -value < 0.05. This research proved that the number of audit committee positively affect the relationship of accounting conservatism (ACC\_CON) on equity valuation (PBV). The existence of audit committee in a company, the process of financial reports will be well monitored. Audit committee will ensure that company implements accounting methods or principles that produce accurate and good quality information. Thus, the existence of audit committee will encourage higher accounting conservatism in financial reporting. Then, the quality of financial statements will increase using accounting conservatism and finally will increase equity valuation.

## **5. Conclusion, Limitations, and Recommendation**

### **5.1. Conclusion**

This Accounting conservatism as controversial accounting convention is proved to influence equity valuation. Beside its pros and cons, investors see that companies implement accounting conservatism ensure that earning reported is not overstated. Together with the implementation of good corporate governance that increase monitoring function over financial reporting makes investors feel more comfortable when giving their money. This feeling makes investors undoubtedly assess equity with higher price. This research found that accounting conservatism has positive influence on equity valuation as stated by the previous researcher Amalia (2007) and Pranama (2008).

The corporate governance mechanism like managerial ownership, proportion of independent board of commissioners and audit committee also proved to be moderating variables that strengthen the relationship between accounting conservatism and equity valuation. Corporate governance plays an important role in the implementation of conservatism. Corporate governance ensures that the assets of the firm are used efficiently, prevent the inappropriate distribution of the assets to managers or to other parties at the expense of the rest of stakeholders. Thus, strong corporate governance results in better monitoring of management, produces more timely accounting information, accelerates the recognition of bad news to provide board-of directors with early-warning signals to investigate the reasons for the bad news and reduces the likelihood of incurring litigations costs.

### **5.2. Limitations**

The limitations of this research are as follow :

1. The good corporate governance attributes used as moderating variables are limited to managerial ownership, proportion of independent board of commissioners and audit committee.
2. The results of this research are applied to LQ45 Index.

### **5.3. Recommendations**

The researcher has some recommendations for next researcher. Those recommendations are :

1. Next researcher can use other proxy of accounting conservatism as suggested by Watts (2003a) which are earning/stock return relation measure, earning/accrual measure, and net asset measure.
2. Next researcher also can take sample from all companies listed in Indonesia Stock Exchange for longer period to get more representative result.
3. Since this research only shows 36% of dependent variable is explained by independent variables, the next researcher can search other independent variables that may affect equity valuation like economic condition, market perception, company or world event, human psychology and so on.

## REFERENCES

- Ahmed, A.S. & Duellman, S. (2007). Accounting Conservatism and Board of Director Characteristics: An Empirical Analysis. *Journal of Accounting and Economics*.
- Amalia, D.Y. (2007). *Pengaruh Konservatisme Akuntansi terhadap Penilaian Ekuitas Perusahaan dimoderasi oleh Good Corporate Governance*. SNA Makassar 2007.
- Ball, R., & Shivakumar L. (2005). Earning Quality in UK Private Firms: Comparative Loss Recognition Accounting Earnings. *Journal of Accounting and Economics*, 71, 265-313.
- Bahaudin, A.A. & Wijayanti P. (2011). Mekanisme Corporate Governance Terhadap Konservatisme Akuntansi di Indonesia. *Dinamika Sosial Ekonomi*, 7 (1).
- Basu, S. (1997). The Conservatism Principle and the Asymmetric Timeliness of Earnings. *Journal of Accounting and Economics*, 24(1), 3-37.
- Boediono. (2005). "Kualitas Laba: Studi Pengaruh Mekanisme *Corporate Governance* dan Dampak Manajemen Laba dengan Menggunakan Analisis Jalur", *Simposium Nasional Akuntansi, SNA VIII*, 15-16 September 2005.
- Fala, D.Y.A.S. (2007). Pengaruh Konservatisme Akuntansi Terhadap Penilaian Ekuitas Perusahaan Dimoderasi oleh Good Corporate Governance. *Simposium Nasional Akuntansi X, Makasar*.
- Fama dan Jensen, (1983). Separation of Ownership. *Journal of Law and Economics*, Vol. XXVI, June 1983.
- Francis, B., Hasan I., Wu Q. (2013). The Benefits of Conservative Accounting to Shareholders: Evidence From Financial Crisis. *Accounting Horizons*, 27 (2), 319-346. doi: 10.2308/acch-50431.
- FCGI. 2001. *Corporate Governance: Tata Kelola Perusahaan*. Jilid I. FCGI, Edisi ke-3.
- Givoly, D., and C. Hayn. (2000). The Changing Time-Series Properties of Earnings, Cash Flows and Accruals: Has Financial Reporting Become More Conservative? *Journal of Accounting and Economics* 29,3, 287-320.
- Ghozali, Imam. (2012). *Aplikasi Analisis Multivariate dengan Program SPSS*. Semarang: BPFE Universitas Diponegoro.
- Gujarati, D. (1993). *Basic Econometric*. Fourth Edition. McGraw-Hill Book Co.
- Hart. (1995). Strategic Reference Point Theory. *Strategic Management Journal*, Vol. 17, 219-235.
- Hati, L.A.D. (2011). Telaah Literatur Tentang Faktor-faktor yang Mempengaruhi Konservatisme Akuntansi. *Journal Ekonomi dan Pendidikan*, 8 (2).
- Jensen, M & Meckling W. (1976). Theory of The Firm: Managerial Behavior, Agency Cost, and Ownership Structure. *Journal of Financial Economics*, 3, 305-360.
- Jogiyanto. (2000). *Teori Portofolio dan Analisis Investasi*. Yogyakarta: BPFE.
- Lara J.M.G., Osma B.G., Penalva, F. (2005). *Accounting Conservatism and Corporate Governance*.



- OECD. (2004). OECD Principles of Corporate Governance, OECD Publication Service.
- Penman, S.H, dan Zhang, X.J. (2002). "Accounting Conservatism, the Quality of Earnings, and Stock Returns." *The Accounting Review*, 77: 237-264.
- Pranama,S. (2008). Pengaruh Konservatisme Akuntansi, Good Corporate Governance dan Kualitas Laba Terhadap Penilaian Ekuitas Pada Perusahaan Manufaktur di Bursa Efek Indonesia. *Skripsi*. Universitas Pembangunan Nasional "Veteran Yogyakarta.
- Sandra, D dan Kusuma, W. (2004). *Reaksi Pasar terhadap Tindakan Perataan Laba dengan Kualitas Auditor dan Kepemilikan Manajerial sebagai Variabel Pemoderasi*. Simposium Nasional Akuntansi VII, 2-3 December, Denpasar, Bali.
- Siallagan, H. dan Mas'ud Machfoedz. (2006). Mekanisme *Corporate Governance*, Kualitas Laba dan Nilai Perusahaan. *Simposium Nasional Akuntansi, SNA 9*, August 2006.
- Suaryana, Agung. (2005). *Pengaruh Komite Audit terhadap Kualitas Laba*. Universitas Udayana.
- Sulistiyanto, H. Sri. (2008). *Manajemen Laba, Teori dan Model Empiris*. Jakarta: PT Gramedia Widiasarana Indonesia (Grasindo).
- Suwardjono. (2005). *Teori Akuntansi*. Jakarta: Salemba Empat.
- Walsh, Ciaran. (2003). *Key Management Ratios: Rasio-rasio Manajemen Penting Penggerak dan Pengendali Bisnis*. 3rd Ed. Jakarta: Erlangga.
- Watts,R.L. (2003a). Conservatism in Accounting Part I : Explanations and Implications. *Accounting Horizons*, 17,207-221
- Watts,R.L. (2003b). Conservatism in Accounting Part II: Evidence and Research Opportunities. *Accounting Horizons*, 17, 287-301.
- Wolk, H.I., M.G. Tearney, dan J.L. Dodd. (2001). "*Accounting Theory: A Conceptual and Institutional Approach*." Fifth Edition. Ohio: South-Western College Publishing.
- World Bank. (1999). Corporate Governance: A Framework for Implementation.
- Wulandini,D. (2012). Pengaruh Karakteristik Dewan Komisaris dan Komite Audit Terhadap Tingkat Konservatisme Akuntansi (Studi Empiris pada Perusahaan Manufaktur yang Terdaftar di BEI Tahun 2008-2010). *Skripsi*. *Diponegoro Journal of Accounting*, 1 (2), 1-14.
- Xie B., Davidson W.N III., DaDalt P.J. (2003). Earnings Management and Corporate Governance: The Role of the Board and the Audit Committee. *Journal of Corporate Finance*, 9 (3), 295-316

## APPENDIX I

**Table 4.1. Descriptive Statistics**

Descriptive Statistics					
	N	Minimum	Maximum	Mean	Std. Deviation
PBV	87	.2565	40.8316	4.574412	6.6590854
ACC_CON	87	-.1642	.1666	-.011837	.0679804
MO	87	.0000	1.0000	.048286	.1806953
Prop	87	.1667	1.0000	.438475	.1385099
AC	87	3.0000	8.0000	3.735632	1.1559731
Valid N (listwise)	87				

**Table. 4.2. Multiple Regression Analysis**

Coefficients <sup>a</sup>								
Model		Unstandardized Coefficients		Standardized Coefficients	t	Sig.	Collinearity Statistics	
		B	Std. Error	Beta			Tolerance	VIF
1	(Constant)	1.517	2.660		.570	.570		
	ACC_CON	9.286	4.060	.098	2.287	.039	.634	1.577
	MO	-2.280	4.280	-.062	-.533	.596	.601	1.664
	Prop	18.368	4.435	.382	4.141	.000	.952	1.050
	AC	-1.377	.535	-.239	-2.574	.012	.940	1.064
	MO.ACC_CON	25.586	10.778	.044	2.374	.026	.588	1.700
	Prop.ACC_CON	167.137	44.067	.792	3.793	.000	.186	5.384
	AC.ACC_CON	13.745	5.290	.590	2.598	.011	.157	6.358

a. Dependent Variable: PBV

### Model Summary<sup>b</sup>

Model	R	R Square	Adjusted R Square	Std. Error of the Estimate	Durbin-Watson
1	.600 <sup>a</sup>	.360	.303	5.5588852	1.834

a. Predictors: (Constant), AC.ACC\_CON, Prop, MO, AC, ACC\_CON, MO, ACC\_CON, Prop.ACC\_CON

b. Dependent Variable: PBV

**Table 4.4. F Test**

**ANOVA<sup>b</sup>**

Model		Sum of Squares	df	Mean Square	F	Sig.
1	Regression	1372.339	7	196.048	6.344	.000 <sup>a</sup>
	Residual	2441.195	79	30.901		
	Total	3813.534	86			

a. Predictors: (Constant), AC.ACC\_CON, Prop, MO, AC, ACC\_CON, MO.ACC\_CON, Prop.ACC\_CON

b. Dependent Variable: PBV

**Table 4.5 T Test**

Variabel	Beta	T Count	Sig.	Explanation
(Constant)	1.517	0.570	0.570	
ACC_CON	9.286	2.287	0.039	H <sub>1</sub> accepted
MO	-2.280	-0.533	0.596	-
Prop	18.368	4.141	0.000	-
AC	-1.377	-2.574	0.012	-
MO.ACC_CON	25.586	2.374	0.026	H <sub>2a</sub> accepted
Prop.ACC_CON	167.137	3.796	0.000	H <sub>2b</sub> accepted
AC.ACC_CON	13.745	2.598	0.011	H <sub>2c</sub> accepted

## APPENDIX II LQ 45 Companies

No	IDX Code	Companies
1	AALI	Astra Agro Lestari Tbk.
2	ADRO	Adaro Energy Tbk.
3	ANTM	Aneka Tambang (Persero) Tbk.
4	ASII	Astra International Tbk.
5	BBCA	Bank Central Asia Tbk.
6	BBNI	Bank Negara Indonesia Tbk.
7	BBRI	Bank Rakyat Indonesia Tbk.
8	BDMN	Bank Danamon Indonesia Tbk.
9	BMRI	Bank Mandiri (Persero) Tbk.
10	BUMI	Bumi Resources Tbk.
11	ELTY	Bakrieland Development Tbk.
12	ENRG	Energi Mega PersadaTbk.
13	GGRM	GudangGaramTbk.
14	INCO	Vale Indonesia Tbk.
15	INDF	Indofood SuksesMakmurTbk.
16	INDY	Indika Energy Tbk.
17	INTP	Indocement Tunggul Perkasa Tbk.
18	ITMG	Indo TambangrayaMegahTbk.
19	JSMR	JasaMargaTbk.
20	KLBF	Kalbe FarmaTbk.
21	LPKR	LippoKarawaciTbk.
22	LSIP	PP London Sumatra Indonesia Tbk.
23	PGAS	Perusahaan Gas Negara (Persero) Tbk.
24	PTBA	Tambang Batubara Bukit AsamTbk.
25	SMGR	Semen Gresik (Persero) Tbk.
26	TINS	Timah (Persero) Tbk.
27	TLKM	Telekomunikasi Indonesia Tbk
28	UNTR	United Tractors Tbk.
29	UNVR	Unilever Indonesia Tbk.

## Analyzing Report of Acceptance in Import Transaction Using Usance L/C Based on SAK (Standar Akuntansi Keuangan) in the Financial Statement

<sup>1</sup>Rony Wardhana, S.E., M.Ak., <sup>2</sup>Emmaliana Pandan, S.Ak. & <sup>3</sup>Santirianingrum Soebandhi, S.E., M.Com.

<sup>1</sup>Narotama University Surabaya, rony.unnar@gmail.com, 081553355015

<sup>2</sup>Narotama University Surabaya, emmaliana.pandan@gmail.com, 08989876778

<sup>3</sup>Narotama University Surabaya, santirianingrum@gmail.com, 081553019300

### Abstract

Today banks support multi-services for its customers who want to do export-import by using L/C (Letter of Credit). Based on term of payment there are 2 kinds of L/C, sight and usance L/C. This study only discuss usance L/C which the payment will be made at the due date. This will lead to the emergence of acceptances payable account in the financial statement. Acceptance payable is classified into financial instruments based on PSAK 50, PSAK 55, and PSAK 60. And the reporting is regulated by PSAK 1 about short-term liability. This study aimed to analyze whether the acceptance reporting in Bank X Surabaya is in compliance with applicable SAK. Research method is based on descriptive qualitative method. Data were collected from interview, documents analysis, and observation technique of 2013 financial report by using secondary data type. The result showed that the report of acceptance has been in accordance with the latest version of SAK (Revised 2012). This indicates that this bank has followed the applicable regulations in Indonesia. Our study has several limitations, which can offer perspective for future research in other aspects such as analyzing effect of sight L/C in financial report and broader location of banking industry.

**Keywords:** *acceptance, financial instrument, letter of credit (l/c), psak 1, psak 50, psak 55, psak 60*

### 1. Introduction

Bank plays an important role in maintaining economic growth of a state by providing financial services. Bank provides numerous services such as deposit account, clearing service, remittance, home loan (in Indonesia it is known as KPR) and many more. In last three years, international trading transactions in Indonesia tend to be fluctuated. In 2011, Indonesian trading position for export increased up to 29,1% becomes 203,6 billion USD. Meanwhile, trading position for import increased up to 30,7% becomes 177,3 billion USD. Neighbor countries in Asia played role as major trading partners where China is the largest trading partner for Indonesia in 2011 (Annual Report of Bank X 2011). Unlike 2011, Indonesian trading position in 2012 changed since September. Indonesia became net importer due to the increase of import into 8,0% becomes 191,7 billion USD. Meanwhile, trading position for export decreased into 6,6% becomes 190, 0 billion USD. It is influenced by decreasing price of timber and CPO. In 2012, China was still the main trading partner for Indonesia (Annual Report of Bank X 2012).

All economic elements of a state including bank, try to provide services in order to develop export-import transactions in international trading. Besides numerous services that are mentioned above, bank also provides special service which serve export-import transactions by arranging Letter of Credit (herein after referred to as L/C). Based on International Trading Module that is applied by bank X "L/C is a written agreement that is published by issuing bank on the basis of written request that is proposed by importer to exporter in order to pay or approve/accept the draft of agreement or to permit other banks to pay or approve/accept or take over the draft when all documents that need to be submitted by beneficiary are completed or based on terms coupled with conditions that are mentioned in L/C". Acceptance means conducting authorization by submitting promissory note that already signed or legalized. In using L/C, importer is commonly known as applicant meanwhile exporter is commonly known as beneficiary party.

Bank plays different role in which its role depends on the transaction that is handled by them. When bank clients take position as beneficiary party, bank gives their contribution as negotiating bank.

Meanwhile, when bank clients take position as applicant, bank gives their contribution as issuing bank. The tasks of negotiation and issuing bank are different. Negotiation bank is able to take over payment obligation from the issuing *bank* when all documents given by beneficiary party are completed or based on terms coupled with conditions that are mentioned in L/C. Meanwhile, the issuing bank plays role to publish L/C based on request that is proposed by the applicant. It is issued by bank to warrant the beneficiary party that payment obligation will be settled by applicant when all documents that need to be submitted are completed or based on terms coupled with terms and conditions that are mentioned in L/C.

International Trading Module that is applied by bank X mentioned that there are 2 kinds of payment that can be used, which are sight L/C and usance L/C. In sight L/C, beneficiary party will receive the payment after applicant party settled the invoice and collected shipping documents that are sent to the issuing bank. Meanwhile, applicant only needs to give promissory note as warrant when they are applying usance L/C as their payment system. Applicant obliges to pay invoice when due date of the invoice is approaching. Before due date of the invoice, applicant only needs to give promissory note as evidence that the applicant will pay the invoice based on the terms and conditions that are agreed in the contract. Although it is clearly mentioned in the contract, it cannot be ascertained that the applicant has fund to pay the invoice when the due date is approaching. It can be said that non-performing credit can be occurred in this transaction. In order to minimize this issue, management risk concerning this situation needs to be taken.

In providing L/C service in export-import trading, bank obliges to report all activities and predict all risks that might occur in their service. Usance L/C system in import transaction creates the occurrence of payment commitment for acceptance that is conducted by importer/applicant. Based on regulations that are enacted in Financial Accounting Standard (Standard Akuntansi Keuangan “SAK”) the occurrence of payment commitment for acceptance in balance sheet is known as acceptance debt. At the beginning, L/C is regulated in PSAK 31 (revised in 2000) concerning Financing import L/C: Acceptance L/C. In 2012, Statement concerning revocation of Financial Accounting Standard (PSAK) article 4 is emerged in which it caused PSAK 31 (revised in 2000) is not applicable. Regulations regarding L/C transaction nowadays are regulated under PSAK 50 (2010) concerning Financial Instrument: Presentation, PSAK 55 (2011) concerning Financial Instrument: Recognition and Measurement; PSAK 60 concerning Financial Instrument: Disclosure. All of those regulations are implemented starting from 1<sup>st</sup> January 2012. The financial recording is based on PSAK 1 (2009) concerning Financial Report Presentation.

Based on the description above, the present article aims to examine whether acceptances reporting that is made by Bank X Surabaya concerning import transaction under usance L/C system has followed the Indonesian Financial Accounting Standard (SAK) or not. The present study will be divided into three sections. First section will discuss about research methodology that will be applied in the article. Second section will discuss about theoretical background that will be used. The last section will discuss about the result of the research.

## **2. Methodology and Data Collection**

We use qualitative approach by applying descriptive method. According to Gunawan (2013:80) research that uses qualitative approach emphasizes analytical proses of inductive reasoning relates to issues that are going to be elaborated and also supports by scientific logic. Qualitative research aims to develop sensitive concepts in the issues that are going to be examined, illuminating realities that are connected with grounded theory and acquire better understandings of phenomena that are analyzed.

The data are collected by conducting interview with an employee of Bank X that holds responsibility in processing usance L/C for import transaction and creating an account that reports debt in acceptance into company financial report. Moreover, in collecting the data, we also conduct documentation analysis, observation on Bank X financial report that can be downloaded in <http://www.idx.co.id> coupled with official site of Bank X

## **3. Data Analysis Method**

Based on Sugiyono (2009) method in analyzing qualitative data is a process of systematical finding and drafting that can be gained through interview, field note and other sources so the data can be easily

comprehended coupled with informed to other scholars. We use several steps in analyzing the data which are:

1. Determine which company and duration of financial report that are going to be examined. We choose Bank X as the company coupled with its acceptance concerning usance L/C as the object of the research. Meanwhile, Bank X financial report that will be analyzed in the present research is financial report for period 2013.
2. Research process is continued by collecting the data through BEI website <http://www.idx.co.id> and official website of Bank X.
3. Conduct interview regarding the process of acceptance concerning usance L/C for import transaction. We also examine the process of journals input (if there any) into company's system and how does it appears in financial report of the company.
4. Start analyzing the data by examining how acceptance concerning usance L/C for import transaction is reported and compared it with regulations enacted in the Indonesian Financial Accounting Standard (SAK). In comparing, we use PSAK 1, 50, 55 coupled with 60 as the guidelines.
5. Create summary based on the result of the data analysis.

#### 4. Theoretical Background

According to Ismanthono (2010:146), import is the in-flow of goods and services into a state market which can be consumed or as materials to fulfill the local demand of materials for production. Meanwhile, Bank Indonesia defines import based on the regulation implement by Indonesian banking association as commerce by entering goods into Indonesian custom territory under the regulations that are enacted. Based on Indonesian Minister of Commerce decree (2015: article 1 section 2) Letter of Credit herein after referred to as L/C is payment commitment from issuing bank given to receiver/applicant when receiver/applicant already completed all documents that need to be submitted based on terms coupled with conditions as the requirements in publishing L/C. In L/C transaction, there are several parties that are involved in transaction mechanism which are:

1. Exporter (*beneficiary*) is party that exports goods into outside Indonesian custom territory under the regulations that are enacted. Based on its function, exporter can be divided into three which are:
  - a) Exporter. It can be a company or personal that sends goods outside Indonesian custom territory. Example: exporting string, exporting shoes etc.
  - b) Export Merchant House. It is branch office or subsidiary company that helps main corporate in collecting data, doing inspection and packaging goods that are going to be exported by the main corporate. It also has function to purchase goods from production company or corporate and or specialize their service in providing and trading those goods to be traded with countries that demand it.
  - c) Trading Company/Trading House. It is a company that does not produce goods instead of collecting goods that are needed to be exported (this company acts as intermediary).
2. Importer (applicant) is a party that imports goods from abroad into Indonesian custom territory under the regulations that are implemented. Based on its function, importer can be divided into three which are:
  - a) Manufacturers Importer. It is a company that imports raw materials to be produced to become finished goods. Example: A company that imports string to make fabric.
  - b) Special Importer. It is a company that imports certain goods under the government decree. Example: Importing Rice, it is regulated and done by Logistic Business Entities (Bulog).
  - c) Public Importer. It is a company that imports goods to be traded to others and to fulfill their demands. Example: Importing computer, car spare parts etc.
3. Bank, in this situation takes position as intermediary between exporter and importer.

Based on its position as intermediary, roles of Bank X that are mentioned in International Commerce Module (2010: I-4/9) can be divided into:

1. Remitting Bank. Bank has function to submit documents based on collection basis by following an instruction from principal to collecting/presenting bank. The documents mentioned above also need to

be attached with instruction letter (which is also known as collection instruction/schedule of remittance) from remitting bank to the collecting/presenting bank.

2. Collecting Bank. Morally, bank has function to collect invoice payment from benefactor based on collection document that is given by remitting bank.
3. Presenting Bank. Bank that conveys collection document received from remitting bank to the benefactor.
4. Issuing Bank. Bank that publishes L/C based on written request that is proposed by applicant. Bank is obliged to ensure payment to the beneficiary when all documents that need to be submitted are based on terms and conditions that are mentioned in L/C.
5. Advising Bank. Bank that conveys L/C to other party (bank) or delivers L/C to beneficiary and this bank obliges to validity the legitimacy of L/C.
6. Confirming Bank. Bank that adds payment warrant in L/C based on request and authority of the issuing bank. Confirming bank obliges to pay the payment obligation based terms and conditions that are mentioned in L/C.
7. Negotiating Bank. Bank that take over payment obligation from issuing bank for documents that are given by beneficiary. Moreover, those documents should be based on terms and conditions that are mentioned in L/C.
8. Reimbursing Bank. Bank that is instructed or given authority in conducting reimbursement based on invoice/payment authentication that is issued by issuing bank. This bank obliges to pay to the claiming bank under the instruction or authority that is given by issuing bank.

According to Marbun, et.al. (2012: 12) acceptance is a commitment to pay the invoice/payment obligation by benefactor in which benefactor needs to put his/her signature in bank note. Meanwhile, according to Winarno and Ismaya (2012: 12) acceptance is (1) commonly known as statement for loan that is given by other party. (2) Formal action to withdraw bank note. In order to make it legal, beneficiary needs to write "received" and sign the receipt. In other words, acceptance is a signature hub which conform that benefactor is agreed to pay payment obligation as mentioned in the bank note. Acceptance needs to be confirmed with word "accepted/authorized" or using other words which have the same meaning. Signature that is given by benefactor in the receipt/note can be regarded/claimed as acceptance.

Financial Accounting Standard (SAK) that is used in Indonesia is compilation of Financial Accounting Standard Statement (PSAK "Pernyataan Standar Akuntansi Keuangan"), Financial Accounting Standard Interpretation (ISAK "Interpretasi Standar Akuntansi Keuangan"), and Revocation Statement of Financial Accounting Standard (PPSAK "Pernyataan Pencabutan Standar Akuntansi Keuangan"). It is published by accountants that are joined into Indonesian Accountant Association (IAI "Ikatan Akuntan Indonesia").

PSAK 1 (2013: 1.3) mentions that definition of SAK is statement and interpretation that regulated by The Board of Financial Accounting Standard and IAI. This Commissions Board also enact regulations concerning entity in stock market which under their supervision. Nowadays, started from 1<sup>st</sup> June 2012, SAK that can be used as guidelines is SAK 2012.

In 2012, IAI published SAK that has been revised significantly compared to the standard before. The main difference between SAK 2012 compared to standard before is that SAK 2012 adapts International Financial Reporting Standard (IFRS) that is published by International Accounting Standard (IAS). It can be said that SAK 2012 is a convergent of IFRS 2009.

PSAK 31 (2000) concerning Banking Accounting discuss about export and import transaction as follow:

PSAK 31 (2000) Funding in Import L/C: Acceptance L/C

68. When due date of L/C payment is approaching, reimbursement bank will pay to the L/C beneficiary based on nominal amount/value that is mentioned in L/C. Reimbursement bank should acknowledge and report this process in form of invoice to the issuing bank with the same nominal amount/value that is stated in L/C.
69. Regarding acceptance (issuing or non-issuing bank) in giving authorization toward periodic bank note that is published by beneficiary party, therefore authorized bank obliges to acknowledge its responsibility to the beneficiary party of L/C (bank that issue periodic bank note) equivalent to the amount/value of bank note. Authorized bank also should recognize invoice/payment obligation upon applicant of acceptance with the same nominal amount/value.



70. When the bank note mentioned above has been discounted to another bank's party that appointed therefore authorized bank should acknowledge its responsibility to settle invoice/payment obligation to another bank's party with equal amount in bank note that is authorized or at the same moment it is acknowledged as payment obligation dedicated to authorize applicant with equal amount/value as bank note.

Based on Revocation Statement of Financial Accounting Standard (PPSAK) 4 regarding revocation of PSAK 31: Banking Accounting; PSAK 42: Stock Company Accounting; and PSAK 49: Mutual Fund accounting; it is explained that the basis in revocation of those articles are:

- a) Impacts of convergent into International Financial Reporting Standards (IFRS) which stimulate urgency to revoke SAK to avoid overlap regulations towards numerous companies since those regulations already implied in other articles in SAK.
- b) The occurrence of inconsistency of regulations in PSAK 31, PSAK 42 and PSAK 49 under the basic scheme of Financial Drafting and Reporting Standards.
- c) Overlapping regulations occur in PSAK 31; PSAK 42; and PSAK 49 with other articles in SAK for some events or transactions.
- d) Change of concepts or regulations which are used as guidance in drafting SAK for certain industries create situations which make some regulations in SAK not implacable for the latest/contemporary concepts or regulations that have been revised lately.

Referring to explanation above, it can be said that PSAK 31 which also discussed about Letter of Credit is not applicable anymore. Letter of Credit nowadays is discussed in PSAK 50 (2010); PSAK 55 (2011) and PSAK 60. PSAK 50 (2010) addresses Financial Instrument: Presentation; PSAK 55 (2011) addresses Financial Instrument: Recognition and Measurement; PSAK 60 addresses Financial Instrument: Disclosure.

Based on PSAK 50 (2013: 50.1) financial instrument is all contract which add extra amount of financial asset, financial entity and financial liability or equity instrument issued by entity. PSAK 50 (2013: 50.1) aims to determine standard in presenting Financial Instrument as liability or equity and it can be used as standard in terminating financial asset coupled with financial liability. According to PSAK 50 (2013: 50.3) financial liability is:

- a) Contractual liability:
  - (i) To deliver cash or other financial asset to another entity.
  - (ii) To exchange financial asset or financial liability to another entity under the conditions in which that entity does not have profitable potential.
- b) Contracts which or might be achieved by using equity instrument issued by entity and it can be characterized as:
  - (i) Non-derivatives in which entity shall or might need to deliver some amount that are varies from equity instrument that is issued by entity, or
  - (ii) Derivatives that will or might be achieved besides exchanging cash in some amount or financial asset with certain equity instrument that is issued by entity. For achieving this goal, right; option; or warrant will be proposed to non-derivative holders in order to get fixed specific amount to cover equity instrument that is issued by entity. Fixed means in a specific amount which is equal when it is converted to foreign currencies. Moreover, for achieving this goal, financial equity instrument that is issued by entity cannot be regarded as instrument that can be sold. It is stated in articles 13 and 14 that entity obliges to deliver this instrument to other appointed party as protocol asset holder in case of liquidation of entity and it will be regarded as instrument equity based on articles 15 and 16. It also can be determined as contract or agreement which regulates entity as the issuing party to receive or deliver equity instrument in the future.

PSAK 55 (2013: 55.14) describes about initial measurement of financial asset and financial liability that will be explained on sub chapter of the present research concerning liability. PSAK 55 (2013: 55.1) aims to set standard in recognizing and measuring of financial asset and purchasing contract or purchasing or selling contract concerning non-financial items. PSAK 55 paragraph 14 (2013: 55.8) explains that entity acknowledges financial asset or financial liability when and if only when that entity is appointed as party in contract of that instrument. Meanwhile, PSAK 55 paragraph 39 (2013: 55.14)

describes about termination of financial liability acknowledgement in which: entity issues financial liability (or part of financial liability) based on the financial report that is elaborated by entity. When and if only, expiration of that financial liability is approaching, namely when liabilities that are mentioned in contract are released or cancelled or expired. In measuring financial liability, PSAK 55 paragraph 43 (2013: 55.14) describes as follow: In initial process of determining financial liability coupled with financial asset recognition, entity is measured based on its reasonable value. Regarding financial asset or liability, it does not measure based on reasonable profit and loss. It is measured based on reasonable value plus transaction cost that can be attributable directly with acquisition or issuance of financial asset or financial liability.

PSAK 60 (2013: 60.1) aims to presuppose entity in providing disclosure in financial report which makes users easy to evaluate:

- a) Financial instrument significance towards position coupled with performance of financial entity; and
- b) Characteristic and scope of risks that might occur from financial instrument which can be seen from early up to present period of entity financial report, coupled with how entity manages those risks.

Meanwhile, PSAK 60 paragraph 07 (2013: 60.2) describes that entity should provide information which helps users easy to evaluate financial instrument significance toward position and financial performance. If it is elaborated further, although L/C nowadays is regulated under PSAK 50, PSAK 55, and PSAK 60, each entity should notice PSAK 1 (2009) concerning presentation of financial report. Acceptance debt that will be discussed in the present research can be concluded as financial liability coupled with its presentation based on PSAK 1 paragraph 70 (2013: 1.13). It is mentioned that entity is able to conform financial liability as short term liability in which the expiration date of that liability will be expired in 12 months after its reporting period, although:

- a) In contract it is mentioned that the duration of initial conditions of agreement is more than twelve months.
- b) Agreement for re-financing or re-scheduling of payment is based on long term duration that have been completed after reporting period and/or before financial report been authorized to be published.

SAK revised in 2012 explains that liability is debt of corporate in recent years that occurred in the past. Completion concerning this issue is expected to result outcomes dedicate to corporate resources that contains economic beneficial. Meanwhile, SAK ETAP (2009: ETAP.6) explains that liability is current liability that is occurred because of past issues, which completion concerning this issue is expected to result outcomes dedicate to corporate resources that contains economic beneficial.

In PSAK 1 paragraph 67 (2013: 1.12) it is explained that liability can be classified as short term liability when:

- a) Entity estimates that liability will be resolved in normal operation term;
- b) Entity holds that liability that can be sold;
- c) When due date of that liability is approaching, it should be settled in twelve months after reporting period; or
- d) Liability in any conditions is not holding right to cancel settlement in liability for at least twelve months after reporting period.

Classification of liability that is not mentioned in above description can be concerned as long term liability.

PSAK 1 paragraph 73 (2013: 1.13) describes that entity classifies liability as long term liability when lender is agreed to give grace period of payment at the end of reporting period at least in twelve months after reporting period. Within period where entity is able to improve breaching in agreement, lender cannot request or even force entity to settle the invoice/payment. Meanwhile SAK ETAP (2009: ETAP.7) describes:

2.17 Essential characters of liability mentions that entity has current obligation to take action or making decision in certain ways. Liability can be formed in legal and constructive liability. Liability can be forced based on law as the form of consequence of bounding contract or legislation. Meanwhile, constructive liability occurs when entity is conducting:

- (a) by old practice standard, policies that have been published or specific present statements, entity gives indication to other party in which entity will accept certain responsibility;

(b) It creates impact that stimulates the occurrence of firm and legal expectations to other parties which justify that entity will be responsible for certain obligation.

2.18 Settlement of current liability usually involves cash payment, submission of another asset, granting service, liability replacement above with another liability, or converting liability into equity. Liability can also be terminated with certain ways such as creditor releases or cancels their rights.

According to Pulungan, et. al (2013) there are numerous considerations that need to be noticed in clarifying an event as liability which are:

1. Current liability. Liability holds by entity must be current liability in which its settlement can be settled in the future.
2. Past event. Liability issues which occur shall be events that happened in the past.
3. Dissipation of resource in the future. Settlement of present liability commonly requires sacrifice of resource in the future.

Below is mechanism of export-import transaction using usance L/C based on International commerce module that is applied by Bank X:

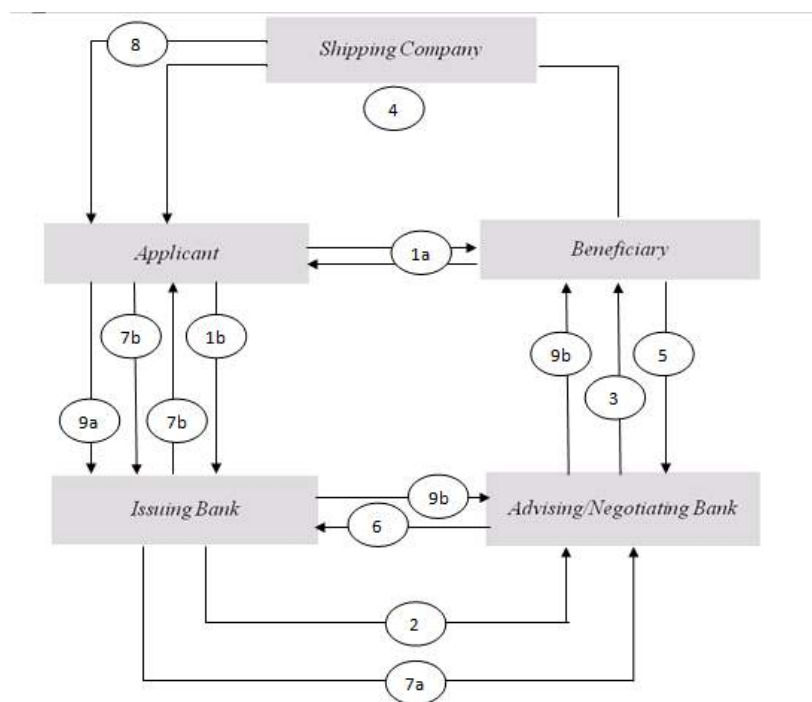


Figure 1 Export-import transaction mechanism using usance L/C

The mechanism:

1. a. Applicant and beneficiary agreed with the agreement  
b. Applicant proposes request to the issuing bank to create L/S
2. After analyzing feasibility of credit applicant, issuing bank publishes L/C to beneficiary through advising bank
3. Advising bank authorizes L/C that is received and delivered it to beneficiary
4. Beneficiary delivers goods coupled with gets notification based on transportation that is used to deliver it
5. Beneficiary conveys document that has been completed according to the terms and conditions in L/C to the negotiating bank

6. After checking and confirming that the document is appropriate, negotiating bank conveys the document to the issuing bank.
7.
  - a. After checking and confirming that the document is based on terms and conditions in L/C, issuing bank conduct acceptance to the negotiating bank
  - b. After holding acceptance from applicant, issuing bank able to convey the document to applicant
8. Applicant picks up the goods through shipping company
9.
  - a. When the due date of invoice is approaching, applicant shall settle the payment to the issuing bank
  - b. Issuing bank remunerates to negotiating bank when the due date of invoice is approaching and delivers it to the beneficiary

## 5. Result and Discussion

Interview is conducted as an initial step to explore begins from transaction process up to the issuance of acceptance that is reported into bank trade application. Data that is collected from interview process can be regarded as qualitative data. We use one respondent that works as operator in payment import division named Mr. Onny. We also analyze other sources such as documentation and journal approvals that appear within bank trade system. Before processing input, first of all operator needs to evaluate L/C tenor that will be processed. Above is the description from respondent:

“As operator, he/she needs to check that applicant opens sight or usance L/C. If it is usance, it has expiration period. When L/C has been issued, it will be reported in debit 53062 and credit 63072 journal”.

Next, there are view steps that need to be done in input process in bank trade system. First of all, when applicant just proposes for L/C issue, then the operator will record the journal as:

D: 53062	USD XXX	
K: 63072		USD XXX

Remarks:

- Mnemonic 53062 is account L/C outstanding usance
- Mnemonic 63072 is liability account which occur from L/C outstanding usance

Although L/C has been issued and never used before, bank has made note as liability. This liability will be displayed as “Irrevocable Letter of Credit Facility”. It is called irrevocable since it cannot be cancelled in a unilateral manner.

Operator will also record journal to debit the commission fees as described below:

D: COVA/COIDR	USD XXX	
K: 31021		USD XXX

Remarks:

- Mnemonic COVA is foreign currency account owned by bank client; meanwhile COIDR is bank client account in Rupiah.
- Mnemonic 31021 is L/C import usance commission.

Based on information that is given, commission value that is charged to client can be varied. Cost that is charged can be varied as well, as described by informant:

“When issuing process begin, bank charged for commission in opening L/C. It is varied depend on the client. Therefore, client account debit can be COIDR atau COVA, meanwhile credit will be reported to 31021 for commission coupled with import commission. When acceptance issued, bank client shall pay Rp. 50.000,- for administration cost or telex cost”.

The next process, issuing bank will receive document from negotiating bank that will be continued with monitoring process by document checking division. Within this process, operator is not conducting any input. Journal Input will be conducted after issuing bank receives acceptance from applicant together with the journal. There are 2 journals that will be recorded, first journal is to omit outstanding usance L/C liability that noted in the beginning process of opening L/C:

D: 63072   USD XXX  
  K: 53062   USD XXX

Remarks:

- Mnemonic 63072 is liability account that occurs in L/C outstanding usance
- Mnemonic 53062 is L/C outstanding usance account

Second journal is for recording liability which has equal amount as written in invoice:

D: 55069   USD XXX  
  K: 65079   USD XXX

Remarks:

- Mnemonic 55069 is bank acceptance invoice of import L/C
- Mnemonic 65079 is liability account for bank acceptance of import L/C.

For additional information, L/C amount is not always equal with invoice amount. It depends on agreement between beneficiary and applicant concerning how much amount that will be charged. Therefore, operator cannot make any mistake in doing report, whether in recording journal input coupled with nominal input. It is confirmed by respondent as follow:

“The amount of invoice is not always equal with L/C amount that issued. It can be more than the invoice or vice versa. So 5509, when 53062 is accorded to the amount of L/C that issued, 55069 accommodate invoice amount. Therefore, invoice amount will be added here (this account). What are 55069? It is acceptance account. 65709 is liability account that occurred because of acceptance. The one that I showed you, it was because outstanding L/C isn’t?”

From the journal mentioned above, it appears section in report that is called “acceptance debt”. It is considered as debt by bank because when the due date of invoice is approaching, bank will settle payment to beneficiary based on amount that is charged. However, bank also makes report named “acceptance bill” since bank has claim from applicant/import client. When due date of invoice is approaching, bank will be debiting fund into client’s account in same amount as mentioned in L/C transaction (invoice amount) plus with commission coupled with interest.

Those journals will be reported in system and automatically will be posted in general ledger (GL). When operator is conducting input, those journals will only be reported in the system. Journals that have been reported will be rechecked by releaser. After being confirmed that report journals are fixed, releaser will release and update journals that existed in general ledger.

Reporting in system will been done when applicant requests for an acceptance. When original document is taken by applicant, bank just makes manual note followed by receipt form about receiving document that signed or authorized.

When due date of debt is approaching, operator will record journal as follow:

D: 65079   USD XXX  
  K: 55069   USD XXX

Remarks:

- Mnemonic 65079 is liability account concerning bank acceptance for import L/C
- Mnemonic 55069 is bank acceptance account concerning bill of import L/C

BANK X			
LAPORAN POSISI KEUANGAN KONSOLIDASIAN (Lanjutan)			
31 DESEMBER 2013			
(Dalam jutaan Rupiah, kecuali dinyatakan lain)			
	Catatan	31 Desember	
		2013	2012
<b>LIABILITAS DAN EKUITAS</b>			
<b>LIABILITAS</b>			
Simpangan dari nasabah	21.2x.16.32,		
Pihak berelasi	35,37	987.860	1.484.745
Pihak ketiga	28,41	408.497.903	368.789.454
Dana simpanan syariah	2y	250.146	232.813
Simpangan dari bank-bank lain	21.2x.16.32,		
	35,37	3.301.039	2.330.295
Liabilitas keuangan untuk diperdagangkan	21.21.9.32,		
	35,37	113.516	48.474
Utang akseptasi	21.2m.10.32,		
	35,37	4.539.442	5.839.495
Efek-efek utang yang diterbitkan	21.2x.18.32,		
	37	3.132.847	2.521.877

Figure 2 Debt presentation in bank financial report concerning acceptance 2013.

Above journal is aimed to terminate amount in liability coupled with amount in acceptance that are charged and reported in financial report. It is omitted since the due date of invoice is approaching and/or it has been settled by applicant.

Research is continued by elaborating for what is called by acceptance debt. Acceptance debt is classified as financial liability. Financial liability of Bank X consists of saving from bank clients, saving from other banks, Financial reliability that can be sold, bank acceptance debt, impacts on debt that are issued, and loans that are received. The present research tries to examine financial liability in form of acceptance debt.

Financial liability initially acknowledged based on the date of commerce in which Bank X takes position as a party in instrumental contract. At the first recognition, financial liability is measured through reasonable value (for items that cannot be measured based on reasonable value it will be measured through loss and profit report after initial recognition) plus transaction cost that will be attributed directly from obtained the issuance of financial asset or liability. Invoice and acceptance debt initially measured based on reasonable value (transaction value mentioned in invoice) plus/minus transaction cost that will be attributed directly and it is a cost to achieve/issue financial asset/liability.

Bank X releases financial liability recognition when liability in contract is terminated or released or cancelled or expired. Meaning of liability releases is when bank X has settled the payment of liability. Cancelled means that parties in contract agreed to cancel all agreements mentioned in contract. Meanwhile, expired means that expiration date of the contract is approaching and all parties agreed that the contract is no longer valid or binding.

Concerning releases of acknowledgement toward financial liability of L/C transaction, Bank X conducts termination of recognition by releasing its liability in contract. Two other ways in terminating liability recognition (by cancelled and expired) can only be done for transaction outside L/C.

Cost that is obtained from amortized is an amount in financial liability that is measured when initial recognition started minus basic payment, plus or minus with cumulative amortized by applying effective rate that is counted from margin between initial amount and due date amount, and minus backup of loss and decreasing of amount. Acceptance debt that is resulted from L/C transaction cannot be amortized since that debt is settled or expired within 6 months period.

According to analyzed data above, it can be concluded that acceptance report in import transaction using usance L/C in Bank X is coming from journals that are noted by operator and released by releaser. It is reported into acceptance debt column since at the time when due date of invoice is approaching, bank will settle the payment to beneficiary an amount of fund that is charged. However, in another side, bank will also report it as acceptance bill in asset column, since it can be regarded as claim from applicant to the bank.

## **5.1 Analysis of PSAK 1 and its practice within entity**

In PSAK 1 paragraph 67 (2013: 1.12) it is explained that liability can be classified as short term liability when:

- a) Entity estimates that liability will be resolved in normal operation term;
- b) Entity holds that liability that can be sold;
- c) When due date of that liability is approaching and it should be settled in twelve months after reporting period; or

Entity in any conditions is not holding right to cancel settlement in liability for at least twelve months after reporting period.

Other explanations concerning classification of liability also described in PSAK 1 paragraph 70 (2013: 1.13) which mentioned that liability can be classified as short term liability when due date of that liability is approaching and it should be settled in twelve months after reporting period; or although:

- a) It is mentioned in initial agreement concerning expiration date of loan will be 12 months period of time; and
- b) Agreement for re-funding, or re-schedule of payment based on long term period can be conducted after settlement of the payment has been settled between reporting period and before the issuance of financial report concerning authorization.

In practice, due date of invoice/payment obligation that is applied in L/C transaction is in range of 30 up to 180 days. Therefore, it can be settled less than 12 months period. It is used by bank to classify bank acceptance as short term liability. Moreover, acceptance that is resulted in L/C transaction cannot be amortized because the duration of payment is less than a year. Although there is no limitation in determining due date of invoice/payment, beneficiary and applicant commonly never applied due date of invoice/payment more than 180 days since it will influence cash flow of their company.

## **5.2 Analysis of PSAK 50 and its practice within entity**

PSAK 50 (2013: 50.1) aims to determine standard in presenting Financial Instrument as liability or equity and it can be used as standard in terminating financial asset coupled with liability. According to PSAK 50 (2013: 50.3) financial liability is:

- (a) Contractual liability:
  - (i) To deliver cash or other financial asset to another entity.
  - (ii) To exchange financial asset or financial liability with another entity under the conditions that the entity does not have profitable potential.
- (b) Contracts which or may be achieved by using entity instrument by issuing equity are:
  - (i) Non-derivatives in which entity shall or might need to deliver some amount that is varies from equity instrument that is issued by entity, or
  - (ii) Derivatives that will or might be achieved besides exchanging cash in some amount or financial asset with certain equity instrument that is issued by entity. For achieving this goal, right; option; or warrant will be proposed to non-derivative holders in order to get fixed specific amount to cover equity instrument that is issued by entity. Fixed means in a specific amount which is equal when it is converted to foreign currencies. Moreover, for achieving this goal, financial equity instrument that is issued by entity cannot be regarded as instrument that can be sold. It is stated in paragraph 13 and 14 that entity obliges to deliver this instrument to other appointed party as protocol asset holder in case of liquidation of entity and it will be regarded as instrument equity based on paragraph 15 and 16. It also can be determined as contract or agreement which regulates entity as the issuing party to receive or deliver equity instrument in the future.

In Bank X financial report, acceptance is regarded as debt that is classified in financial liability. It is happened since that debt appears from financial instrument which is L/C. If referring to conditions mentioned in PSAK 50, it is appropriate with SAK since this liability is in form of contractual liability. Contractual liability, refer to PSAK 50 paragraph 09 (2013: 50.4) is an agreement between two parties or more. It has firm economic consequences coupled with has small tendency for parties to abandon/breach the conditions in the contract since this contract has legal binding conditions.

Contractual liability that is mentioned above is an liability to convey cash or another asset into entity based on time that is agreed. Bank will settle the payment by using cash when the due date of invoice is approaching. Therefore, there will be a movement of cash from issuing bank into negotiating bank and negotiating bank will deliver it into beneficiary. There are two sources of fund (cash) that can be used by issuing bank in settling the payment which are:

1. Fund that is paid by buyer/applicant to issuing bank as form of eligibility concerning payment in which it is signed and followed by submission of promissory note by applicant to the bank.
2. Fund that comes from bank itself, which is caused by disability of applicant in settling the payment at the exact time of expiration date of invoice (non-performing credit). Bank burdens this liability since bank takes position as issuing bank in which as issuing bank, bank provides warrant concerning payment of L/C transaction under two conditions that have been fulfilled, which are:
  - a) Document that is submitted by beneficiary through negotiating bank is based on three standards in international commerce which are: L/C (Letter of Credit), UCP (Uniform Custom of Practices), also ISBP (International Standard Banking Practices).
  - b) Document that is submitted in discrepancy condition but it is already authorized by applicant.

In usance L/C, as long applicant has submitted promissory note, whether the document is in discrepancy condition or not, in this case, issuing bank obliges to deliver cash or other financial assets to other entities/parties. Another entity mentioned here is negotiating bank, in which the fund will be delivered to beneficiary as form of payment.

### **5.3 Analysis of PSAK 55 and its practice within entity**

PSAK 55 (2013: 55.14) describes about initial measurement of financial asset and liability that will be explained on sub chapter liability in present research. PSAK 55 (2013: 55.1) aims to set standard in recognizing and measuring of financial asset and purchasing contract or purchasing or selling contract concerning non-financial items. PSAK 55 paragraph 14 (2013: 55.8) explains that entity acknowledges financial asset or liability when and if only that entity is appointed as party in contract concerning that instrument.

Bank X acknowledges acceptance in L/C as financial liability when Bank X is involved (in this case as issuing bank) in contract and takes position as issuing or negotiating bank; as beneficiary; and/or as applicant. Therefore, what is implied and applied by company (Bank X) concerning recognition of financial liability has been accorded to what is regulated in PSAK 55.

PSAK 55 paragraph 39 (2013: 55.14) describes about termination of financial liability recognition in which: entity issues financial liability (or part of financial liability) based on its financial report. When and if only, the expiration of that financial liability is approaching, namely when liabilities that are mentioned in contract are released or cancelled or expired.

As issuing bank that handles usance L/C transaction, applicant shall deliver fund/cash to Bank X when due date of invoice is approaching based on conditions that are stated in L/C. Therefore, what is reported by bank as acceptance bill will be terminated, followed by reduction of acceptance debt when bank has delivered the fund to beneficiary toward negotiating bank. It means that bank has released liability that is appointed in contract. Based on above explanation, Bank X has right to terminate its financial liability.

In measuring financial liability, PSAK 55 paragraph 43 (2013: 55.14) describes as follow: In initial process of determining financial liability coupled with financial asset recognition, entity is measured based on its reasonable value. Financial asset or liability is not measured based on reasonable profit and loss. It is measured based on reasonable value plus transaction cost that can be attributable directly with acquisition or issuance of financial asset or liability.

In practice, measurement of acceptance bills and debts initially is measured based on fair value plus/minus transaction cost that can be attributable directly and it is an additional cost for issuing the financial asset/liability. It is applied since financial liability cannot be measured based on its fair amount through loss and profit.

### **5.4 Analysis of PSAK 60 and its practice within entity**



PSAK 60 (2013: 60.1) aims to presuppose entity in providing disclosure in financial report which makes users easy to evaluate:

- (a) Financial instrument significance concerning position coupled with performance of financial entities; and
- (b) Characteristic and scope of risks that might occur from financial instrument which can be seen from early up to present period of entity financial report and how entity manages those risks.

PSAK 60 paragraph 07 (2013: 60.2) describes as follow: entity should provide information which helps users easy to evaluate financial instrument significance toward position and financial performance. It means that entity shall provide information concerning disclosure in order to help users in conducting significance evaluation in those instruments.

In report that is made by Bank X for period 2013, subsection point d.1 concerning accounting policy related to standards and changes that are implied effectively in 1<sup>st</sup> January 2013, it is mentioned about appliance of PSAK 60 “Financial Instrument: Disclosure” as follow: Application of PSAK 60 does not have impacts for bank financial result and entity’s branch because those standards only related with disclosure concerning financial instrument. Moreover, disclosure needs to be done in order to manage the risks that might be occurred in financial instrument.

Tabel 1 Analysis Result of SAK compared to Bank X Financial Report

No	Description	SAK	Bank X Financial Report
1	Determining short term liability	Based on PSAK 1 paragraph 67, liability can be classified as short term liability when its due date concerning the payment is approaching and need to be settled within 12 months after reporting period.	It is based on SAK standards. Commonly, due date of payment in L/C transaction range from 30 to 180 days can be regarded as short term liability.
2	Determining Contractual Liability	Based on PSAK 50 paragraph 09: is an agreement between two parties or more. It has firm economic consequences coupled with has small tendency for parties to abandon/breach the conditions in the contract since this contract has legal binding conditions.	It is based on SAK standards. Acceptance debt is regarded to contractual liability in financial liability.
3	Determining Recognition of Financial Asset and Liability	PSAK 55 paragraph paragraph 14 explains that entity acknowledges financial assets or financial liability when and if only when that entity is appointed as party in contract of those instruments	It is based on SAK standards. Bank X acknowledges L/C bank acceptance as financial liability when Bank X is involved (in this case as issuing bank) in contract takes position as issuing or negotiating bank; as beneficiary; and/or as applicant.
4	Termination of Financial Liability	Based on PSAK 55 paragraph 39 (2013: 55.14) entity issues financial liability (or part of financial liability) based on its financial report. When and if only, the expiration of that financial liability is approaching, namely when liabilities that are mentioned in contract are released or cancelled or expired.	It is based on SAK standards. Bank X has released Its recognition by settling the liability. It means that Bank X has settled or paid its liability.
5	Measurement of Financial asset and liability	Based on PSAK 55 paragraph 43: In initial process of determining financial liability coupled with financial asset recognition, entity is measured based on its reasonable value. Financial asset or liability is not measured based on reasonable profit and loss. It is measured based on reasonable value plus transaction cost that is attributable directly with acquisition or issuance of financial asset or financial liability.	It is based on SAK standards. The measurement of payment liability and bank acceptance debt initially is measured based on reasonable value plus/minus transaction cost that can be attributable directly and it is additional cost for issuing those financial asset/liability.
6	Disclosure in financial report	Based on PSAK 60 paragraph 07: entity should provide information which helps users to evaluate financial instrument significance toward position and financial performance. It means that entity shall provide information concerning disclosure in order to help users in conducting significance evaluation in those instruments.	It is based on SAK standards. Bank X has conducted disclosure concerning risks that might be occurred in financial instrument.

## 6. Summary and Suggestion

Financial report of bank X toward acceptance for import transaction that used usance L/C is coming from journals that are reported by operator import payment division. Acceptance is reported as “acceptance debt” in financial report. Acceptance debt is reported when issuing bank provides commitment concerning payment for import transaction. Process that is mentioned above can be described by using picture below:

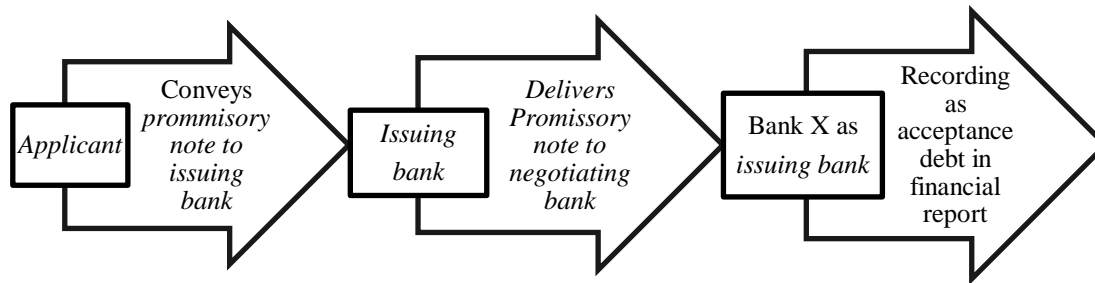


Figure 3 Scheme in acceptance reporting in Bank X financial report  
Source: analyzed data

Based on research that have been conducted, it can be summarized 2013 Bank X Financial Report has been following the standards that are applied in SAK. The results are achieved by comparing 6 points that are mentioned in 4 PSAK which used as standards, those points are:

1. Classification of acceptances debt to short-term liabilities (PSAK 1 paragraph 67)
2. Classification of acceptances debt to contractual liabilities which are included in the financial liability (PSAK 50 paragraph 09)
3. Determining Recognition of Financial Asset and Liability (PSAK 55 paragraph 14)
4. Termination of Financial Liability (PSAK 55 paragraph 39)
5. Measurement of Financial asset and liability (PSAK 55 paragraph 43)
6. Disclosure in financial report (PSAK 60 paragraph 07)

Although result of the research depicts that Bank X financial report has been based on standards in SAK, there are some advises that we will proposed, which are:

1. In financial report, it is not described the description concerning measurement cost that is amortized in L/C transaction. Meanwhile, in bank trade system that is used, the journal concerning amortization process is not occurred. After collecting information, it is known that in L/C transaction, amortization is not conducted since the expiration date in usance L/C is in range from 30-180 days therefore, amortization is not essential. It is recommended that amortization process in usance L/C need to be reported in order to help user of financial report easy to understand concerning that issue.
2. Description concerning measurement of reasonable amount that is applied in L/C transaction does not describe the usage of invoice amount instead of L/C amount. It stimulates miss interpretation for users when they are going to read or use the report. It will be good if above issue is mentioned in the financial report.

Advises mentioned above hopefully able to provide clear information concerning issues that presence in financial report mainly Bank X financial report. Those advises hopefully able to help user of financial report to understand better in reporting or recording events or journals in import transaction that apply usance L/C in financial report.

## 7. Limitation and further research

The present research takes banking as object of the research mainly in agents that provide service concerning export-import transaction using L/C (Agent A in Bank X). The study focuses on how the reporting of acceptance arising from import transactions using usance L/C in the financial statements and also focuses on the correspondence between the acceptances reporting of usance L/C at the current year's financial statements in Bank X with the standards that are applied in SAK that is used in Indonesia.

The present research is limited by import perspective concerning the position of bank as issuing bank. It is influenced since acceptance only occurs when parties are conducting import using L/C. The present study has several limitations, which can offer perspective for future research in other aspects such as analyzing effect of sight L/C in financial report and broader location of banking industry.

## 8. References

- Bank X Financial Report, Available at: <http://www.idx.co.id>, accessed October 10<sup>th</sup> 2014
- Gunawan, Imam. 2013. *Metode Penelitian Kualitatif Teori & Praktik*, Jakarta: Bumi Aksara
- Ikatan Akuntansi Indonesia (IAI). 2009. *Standar Akuntansi Keuangan Entitas Tanpa Akuntabilitas Publik*, Jakarta: IAI
- Ikatan Akuntansi Indonesia (IAI). 2013. *Standar Akuntansi Keuangan Per 1 Juni 2012*, Jakarta: IAI
- Ismanthono, Henricus W. (2010). *Kamus Istilah Ekonomi dan Bisnis*, Jakarta: Kompas
- Marbun, Rocky, et.al. (2012). *Kamus Hukum Lengkap*, Jakarta: VisiMedia
- Menteri Perdagangan Republik Indonesia (2015). *Peraturan Menteri Perdagangan RI Nomor 04/M-DAG/PER/1/2015 Tahun 2015 Tentang Penggunaan Letter of Credit untuk Ekspor Barang Tertentu*, Jakarta: Sekretariat Jenderal Menteri Perdagangan.
- Sugiyono. (2009). *Metode Penelitian Kuantitatif Kualitatif dan R&F*, Bandung: Alfabeta
- Tim Penulis Bank X. (2012). *Modul Perdagangan Internasional Bank X*, Jakarta: Bank X
- Tim Penyusun Laporan Tahunan Bank X. (2011). *Laporan Keuangan*, Jakarta: Bank X
- (2012). *Laporan Keuangan*, Jakarta: Bank X
- (2013). *Laporan Keuangan*, Jakarta: Bank X

## **Business Ethics and Corporate Social Responsibility (CSR) in Sustainable Development: A conceptual framework**

Irham Fahmi<sup>1</sup>

Rudy Fachruddin<sup>2</sup>

1 & 2 Lecture of Syiah Kuala University, Banda Aceh, Indonesia

Corresponding author: [irhamfahmi@yahoo.com](mailto:irhamfahmi@yahoo.com)

### **Abstract**

Currently the company is not only the responsibility solely to give satisfaction to the shareholders, but includes being able to implement and apply the concept of Corporate Social responsibility (CSR). Furthermore Corporate Social responsibility (CSR) also has a close relationship with business ethics. Because the business is far from ethical values is a business that does not have a responsibility to the environment. Business Ethics and Corporate Social Responsibility (CSR) is a concept is expected to promote the realization of sustainable development. Sustainable development is a desire to build order of a society that is more civilized, and prosperous. Basic company's current business operations on the concept of triple bottom line of building balance ethical business, responsible for the environment and promote sustainable development. That is the power of synergy will bear the purpose of high value and are able to realize the long-term changes in people's lives.

***Keywords: business ethics, corporate social responsibility, and sustainable development***

### **1. Introduction**

In the basic concept that the main purpose of the establishment of the company to make profits and business sustainability. The gain is illustrated in the form of acceptance in dividends for the shareholders. But today it is the responsibility of the company is not merely to give satisfaction to the shareholders, but including the responsibility to consider the condition of the environment in which they operate. Concern about the environment more broadly termed Corporate Social Responsibility (CSR).

The application and effect of corporate social responsibility itself very much and are multiplying effect. Concern of the company is able to accelerate development that is sustainable. Further hope in the formation of the order of development that is stable and sustainable.

Conceptually, CSR is an approach whereby companies integrate social concerns in their business operations and in their interaction with stakeholders based on the principle of voluntarism and partnership.<sup>[1]</sup> This means that the company must see if CSR is not a program of coercion but the form of solidarity towards fellow human beings, which helps release the parties from the difficulties that plagued them. And the effect later for the company as well, not just giving short term operating influence but also able to give the effect of the long-term operations including a positive effect on company value in the eyes of the stakeholders.

## **2. Objective**

This study aims to look at the business strategy with the implementation of business ethics, corporate social responsibility, and sustainable development applications with theoretical approach.

## **3. Research Methodology**

### **3.1. Population and Sample**

The population and sample in this research were experts who have insight into business ethics, corporate social responsibility, and sustainable development.

### **3.2. Data Collection**

The data obtained were divided to two sources, first primary data is the result of interviews with the experts in business ethics, corporate social responsibility, and sustainable development. The second data is study of

literature, from various books, journals and other written sources that are considered have relevance.

### **3.3. Data Analysis Method**

Methods of data analysis here is descriptive or explain based on existing conditions with the support of expert opinion as a justification amplifier analysis. However, in this paper we only focused on theoretical aspect of the research topic.

## **4. Result/Conclusion**

### **4.1 Business Ethics Concept**

Business ethics are rules that affirm a business must not be allowed to act and act , where such rules can be derived from the rules of written and unwritten rules.

### **4.2 Corporate Social Responsibility (CSR) Concept**

Corporate Social Responsibility is the commitment of the company or business to contribute to sustainable economic development with attention to corporate social responsibility and focuses on the balance between attention to aspects of economic, social , and environment.<sup>[2]</sup>

### **4.3 SustainabilityDevelopment Concept**

Sustainable economic development is a desire to build community economic order that is prosperous, secure and Sentausa. By promoting the concept of economic development planned and consistent.

### **4.4 Corporate and Principle of Corporate Social Responsibility (CSR)**

A discussion of CSR in this era began to rise with the many problems faced by society as a result of the actions of the company. CSR is long word is didegungkan to the surface, but less strong response from the public. Around 1955, a prominent social commentators named Howard

Robert Bowen had argued about the need for a company to pay more attention to the surrounding communities where the company is located. And this was reinforced by the publication of the book by Howard Robert Bowen, entitled *Social Responsibilities of the Businessman*. Books published in the United States that became a bestseller in the business world in the era of 1950-1960.<sup>[3]</sup>

## **5. Discussion**

A business that is not able to provide welfare to the community is considered as a form of unsuccessful effort, but on the contrary if he is able to contribute to the communities where the company is deemed he has succeeded. This opinion is confirmed by Howard Robert Bowen as the originator of the concept of CSR.

But the reality of the current condition of the position of the company and the community has awakened the social contract (social contract). The social contract is an agreement that is "implicit," society provides social legitimacy (the right to exist) on the presence of the corporation, and vice versa economic benefits generated business should also be distributed to the public (in return for on certain benefits).<sup>[4]</sup>

We understand that the cases of commotion within the company at this time due to the surrounding communities do not feel their contribution to the company. So this raises protest from the public. Persists even in the form of demonstrations and other anarchist action. Cases of violence in Papua is between the company Freeport to cause fatalities is not because of the company to be indifferent to the protests, and similar cases like this also happened in other places in Indonesia.

During this time the contract is made only deal with the investor and the government alone without involving the local community. While at this time with the modern technology so is the direct cause of any information (direct information). Society can quickly feel the changes that occur quickly.

And this condition makes people question their social rights are not met, or are known to social justice.

And social justice can't be obtained before they acquire the social contract in advance as a form of a desire to build a welfare together with full public involvement. It can be interpreted if the social contract seeks to realize the creation of equitable distribution of well-being or welfare.

The interpretation of the distribution of welfare here understood as the attention of the owners of wealth to the people who are considered worthy to receive it, including the company with the community. With the concept of the relationship is expected harmony with the community management company are disconnected in the form of a balanced agreements. Society is in this perspective is called with the stakeholders and the shareholders referred to stockholders.

Stockholders are those who have a number of funds that are deposited in the company to be managed and given the advantages, such as in the form of shares (stock). While there are many types of stakeholders, such as suppliers (suppliers), business partners, creditors, government, corporate employees, consumers, and society .

Poverty can not be resolved by giving charity as practiced by the rich, but poverty should be careful management planning and seen the factors that cause why it could Happen and Including how to tackle the problem in order to finish up the basic problem.<sup>[5]</sup>

During this critical view assumed if poverty reduction is done by the Government does not touch the substance of the issue, including the welfare program in the field of charitable aid.

It is as stated by Edi Suharto<sup>[6]</sup> that "welfare program issued by the government and charities seen as an attempt to maintain poverty." And poverty occurs and lasts from year to year without settlement will cause disruption of development, including deemed not able to realize the establishment of sustainable development.



The interpretation of the meaning of development, according to Schumpeter in his Theory of Economic Development, quoted by ML Jhingan<sup>[7]</sup> said "Development is a change in the spontaneous and discontinuous in the channels of the circular flow, disruption of the balance that is always changing and change the state of balance before". As is circularly by Schumpeter here is a production of goods and services that are performed repeatedly with the aim to continue to meet the needs of human life.

And poverty itself can be caused by various reasons, so that finally emerged poverty theory to explain it. Conceptually, there are several theories that could explain the causes of poverty: poverty cultural perspective, the functionalist perspective, the perspective of the conflict, and interactionist perspective. (Zastrow, 200a; Zastrow, 200b; Suharto, 2006b).<sup>[8]</sup> For some people, poverty actually seen as something beneficial, and this opinion is generally applicable for the rich who do not care about poverty reduction efforts. And further they assume if poverty has many functions.

If we go back to the basic concept of CSR, based on the opinion of DodyPrayogo<sup>[9]</sup> said, "If the substance squeezed anyway, CSR consists of two things namely" commitment "and" action "(action) corporation. In other words, if the corporation does not have a strong commitment to reduce poverty then we do not have to hope there will be action. And in the opinion of many people a company to realize the CSR commitment should be urged or pressed so that he would carry it out. One of the parties that can suppress this is NGO Organization, as well as several other non-governmental organizations. Some evidence of the success of NGOs in support of poverty reduction have shown evidence for this. However, problems often arise when NGO work is temporary, and they also have funding (donor) while donors are also in the decision really depends on the situation and conditions.

And we can see clearly if CSR is one solution that is constructive in building a sustainable development in the form of poverty alleviation as well as various other community development programs. And so there is no business ethics if a company does not apply the concept of CRS in earnest.

## 6. Recommendation

Business ethics and CSR is a unified whole that is mutually supportive towards the strengthening of the company, not only internally but also in terms of the external aspect of course . The government could consider if the CSR program are able to accelerate the realization of sustainable development. And further all that can ease the burden of the government in an effort to realize the public welfare.<sup>[6]</sup>

## 7. Acknowledgment

In making this research we get a lot of input thinking of Mr. Muslims A. Djalil and other parties who can't mention his name. And encouragement of Shyia Kuala University rector in so high a spirit to give you the motivation to continue to conduct research and development to scientists. And all of this award will be our guard and keep it as a form of mandate for us.

## 8. Reference

- [1] Edi Suharto, *Pekerjaan Sosial di Dunia Industri; Memperkuat CSR (Corporate Social Responsibility)*, Bandung, Alfabeta. Page. 103.
- [2] Suhandari M. Putri, Schema CSR, Kompas, 4 Agustus 2007. Dalam Hendrik Budi Untung, 2008, *Corporate Social Responsibility*, Jakarta. Sinar Grafika. Page. 1.
- [3] Hendrik Budi Untung, 2008, *Corporate Social Responsibility*, Jakarta, Sinar Grafika. Page. 37.
- [4] Dody Prayogo, 2011, *Socially Responsible Corporation; Peta Masalah, Tanggung Jawab Sosial dan Pembangunan Komunitas pada Industri Tambang dan Migas Indonesia*, Jakarta, UI-Press. Page. 74.
- [5] Manuel G. Velasque, 2005, *Etika Bisnis, Konsep dan Kasus*, Edisi 5, Andi, Yogyakarta. Page. 10.

- [6] Edi Suharto, 2008, *KebijakanSosialsebagaiKebijakanPublik*, Bandung, Alfabeta. Page. 79.
- [7] M.L. Jhingan, 2000, *Ekonomi Pembangunan danPerencanaan*, PT Raja GrafindoPersada, Jakarta (translete). Page. 125.
- [8] In book Edi Suharto, 2008, *KebijakanSosialsebagaiKebijakanPublik*, Bandung, Alfabeta. Page. 75.
- [1] Dody Prayogo, 2011, *Socially Responsible Corporation; Peta Masalah, Tanggung Jawab Sosial dan Pembangunan Komunitas pada Industri Tambang dan Migas Indonesia*, Jakarta, UI-Press. Page. 77.

# IMAGE, TRUST AND SOCIAL IDENTIFICATION AS PREDICTORS OF CUSTOMER LOYALTY

Lerbin R. Aritonang R.

Economics Faculty of  
Tarumanagara University, Jakarta, Indonesia  
[aritonanglerbin@gmail.com](mailto:aritonanglerbin@gmail.com), 0816759105

## ABSTRACT

In marketing perspective, a student loyalty is a key objective for many higher education institutions since a loyal student population is a source of competitive advantage. The specific purpose of this research is to develop an empirical model linking student loyalty to student image, student trust and student social identification to the institution. Data was collected from 242 undergraduate management and accounting students of the Faculty of Economics, Tarumanegara University, Jakarta. Empirical investigation was carried out to validate the frame work through measurement reliability, validity and testing the significance of relationship structure using regression analysis. The results suggest that image, trust and social identification are positive and significant predictors of loyalty. Based on the results, managerial implications and future researches are suggested.

Keywords: image, trust, social identification, loyalty, higher education students, Indonesia

## INTRODUCTION

In competitive markets, it was verified that developing and retaining relationship with customers is better than recruiting new customers (Gummesson, 1994; Gronröos, 1990). The condition drives companies to explore how to increase retained customers because it relates to the increase of companies' profit (Fornell & Wernerfelt, 1987). Accordingly, researches indicated that customers who have strong relationship with companies are more profitable because they buy regularly (De Wulf *et al.*, 2001), buy more product (De Wulf *et al.*, 2001), willing to pay more (Dowling & Uncles, 1997), and cheaper to serve them (Rigby *et al.*, 2002 in Grégoire & Fisher, 2006). Loyal customers may also increase corporate revenue (Reichheld, 1993), and more possibly buy other products from the same corporate (Clark & Payne, 1994 in Gwinner *et al.*, 1998), specifically decrease switched customers (Reichheld & Sasser 1990), and frequently create new business for the corporate by word-of-mouth recommendations (Zeithaml *et al.*, 1996; Reichheld & Sasser, 1990). Loyal customers may also decrease cost (Reichheld, 1993) because they serve cheaper (Reichheld, 1996 in Gwinner *et al.*, 1998), sale, marketing and setup cost may be aborted for customers who longerly retained (Clark & Payne, 1994 in Gwinner *et al.*, 1998).

According to Hennig-Thurau *et al.* (2001), student loyalty is the main objective of numerous higher education institutions for three arguments. First, tuition fee is the main source of income for most privately-owned universities. For higher education institutions retaining students will have a good and predictable financial basis for their future activities. Second, students' loyalty to their higher educational institutions may positively influence the quality of teaching through their active participations and committed behavior. The last reason, loyal students may continually support their academic institution financially after graduating, through word-of-mouth promotion or some forms of alumni cooperation.

Even though the concept of relationship marketing has begun to influence marketing practices and academic research in various areas and industries, it is for the most part ignored by higher educational institutions (Hennig-Thurau *et al.*, 2001). Therefore, there are few studies on the relations between higher education institutions and their students, such as presented in Table 1. The aim of this research is explaining student loyalty in a higher education institution by examining the variables during the academic years. These variables (image, trust, and social identification) are articulated in a model. Based on research studies listed in Table 1, this study adds a new independent variable, i.e. image.

Table 1. Summary results of student loyalty research,  
with student loyalty as the dependent variable

Researchers	Variables to explained	Result	Subject
Hennig-Thurau <i>et al.</i> (2001)	Trust Quality Goal commitment Emotional commitment Cognitive commitment	-no sign +sign +sign -sign -sign	German: graduates and dropouts university
Helgesen and Nettet (2007)	Image UC, Service Quality Image study, Facilities Satisfaction	+sign + +sign	Norway
Brown and Mazzarol (2009)	Evaluative satisfaction Emotional satisfaction SQ, Value	+sign +sign	Australian universities
Rojas-Mendez <i>et al.</i> (2009)	Commitment Trust Satisfaction	+sign +sign +sign	Chile: college of business
Mohamad and Awang (2009)	Corporate image Service quality Students' satisfaction	+sign +sign +sign	
Gulid (2011)	Satisfaction -> attitudinal loyalty Satisfaction -> behavioral loyalty	+sign +sign	Thailand
Phadke (2011)	Satisfaction Perceived value Affective commitment SQ, Fee fairness	+sign +sign +sign	India
Thomas (2011)	Satisfaction Reputation via satisfaction	+sign +sign	India
Kheiry <i>et al.</i> , (2012)	Satisfaction, Expectation University image Quality, Value, WOM	+sign +sign	Iran
Aritonang R. (2014)	Satisfaction Trust Social identification	+sign +sign +sign	Indonesia

## THEORITICAL FOUNDATION AND DEVELOPING HYPOTHESIS

*Consumer loyalty.* Consumer loyalty is defined by Oliver (1997: 392) as follows: ". . . a deeply held commitment to rebuy or re-patronage a preferred product/service consistently in the future, thereby causing repetitive same-brand or same brand-set purchasing, despite situational influences and marketing efforts having the potential to cause switching behavior." From the definition it can be seen that consumer loyalty includes behavioral and attitudinal elements. Behavioral element is manifested in repeated purchases of the same product. Attitudinal element is manifested in depth commitments for the behavioral element. Another thing that can be seen from the definition, i.e. loyalty is not easily affected by situational conditions such as marketing efforts by the company's competitors.

If we carefully examine, the definition proposed by Oliver is a commitment. It means that customer loyalty is a commitment (promise) without behavior (purchase). Commitment, of course, cannot be directly attributed to the purchase (and consumption) of a product so that there is no revenue for the company.

Another opinion on consumer loyalty was proposed by Jacoby and Kyner (1973). According to them there are six conditions that are collectively sufficient to express consumer loyalty. Those are (1) random (bias), (2) behavioral responses (buying), (3) expressed from time to time, (4) by the decision-making unit, (5) related to one or more of a set of similar brand, and (6) is a function of psychological processes, namely evaluative process to make a decision. Based on their opinion, it can be seen that consumer loyalty is a consumer behavior to repeatedly buy the same or similar product or brand from time to time through an evaluative process.

At least there are two things that distinguish the definition Oliver (1997) and Jacoby and Kyner (1973). One, Oliver definition of consumer loyalty is not about behavior but promise (commitment) to repeatedly buy, while Jacoby and Kyner's allegiance is about repeated buying. Two, Oliver did not mention the brand alternatives available, while Jacoby and Kyner stated that consumers have an alternative brand.

There is one important thing about consumer loyalty but not covered in the above opinions, i.e. the attitudinal aspect in the form of happiness. Customers' repeated purchase of the same product may occur because of they are forced to do so, without pleasure feeling. For example, consumers have no alternative products to meet their needs because they have no access to reach convenient places to buy the product. However, such forced buying condition can not be expected to repeatedly happen. For example, if there are alternate products in the customers' area, it is difficult to be expected that the customers will continue buying and/or consuming the same product.

From the above case, it can be concluded that consumer loyalty is the behavior and commitment of the consumer to buy the same product again and again accompanied by the feelings of pleasure. Thus, consumer loyalty connotes repetitive behavior in the past. The behavior of consumers buying the same products in the future more accurately expressed as intention or commitment to the consumer, not loyalty.

The concept of consumer loyalty as a repeatedly purchasing the same product (Sheth & Mittal, 2004; Neal *et al.*, 1999; Dick & Basu, 1994) is often debated because it does not distinguish the pure from the spurious loyalty (Day, 1969), does not indicate whether the consumer is actually fond of a certain product than the other similar products (Sheth & Mittal, 2004). Consumer loyalty should present the relative attitude and repeat purchases of a product (Dick & Basu, 1994; Grisaffe, 2001).

Consumer loyalty in service context may be indicated through repeated purchases or intention to buy (Rust *et al.*, 1995; Cronin & Taylor, 1992). Associated with it, the following is one of the definitions of loyalty expressed by Reichheld (2002 in Shoemaker & Bowen, 2003: 48):

"A loyal customer is one who values the relationship with the company enough to make the company a preferred supplier. Loyal customers don't switch for small variations in price or service; [instead] they provide honest and constructive feedback, they consolidate the bulk of their category purchases with the company, they never abuse company personnel, and they provide enthusiastic referrals."

In durable products context, including higher education services, behavioral loyalty is not appropriate to be applied. The reason is that there may not be people who buy the services of the same higher education more than one time. On that basis, the intention is used to represent consumer loyalty in this study.

*Company image.* There are several terms used to designate image of company, namely reputation, identity, prestige, goodwill, esteem, and standing (Wartick, 1992). According to Barich and Kotler (1991), company image was described as "the overall impression made on the minds of the public about a firm". Nguyen and Leblacn (2001) also stated that the company image associated with physical and behavioral attributes of the company, such as business name, architecture, variety of goods / services, and the impression of quality that is communicated by each person who interacts with the company's clients.

According to Minkiewicz and Evans (2011: 192), "Corporate image . . . is defined as stakeholders' beliefs, perceptions, feelings and attitudes towards an organization. The stakeholders, according to Minkiewicz and Evans (2011: 191), is outside the company.

Another opinion of company image was presented by According Wartick (1992: 34) as "the aggregation of a single stakeholder's perceptions of how well organizational responses are meeting the demands and expectations of many organizational stakeholders . . . ." So, company or organization image is an aggregation of stakeholder perceptions about organizational response to meet the demands and expectations.

Corporate image is the result of a process (MacInnis & Price, 1987). That process is derived from the ideas, feelings and experiences with the company remembered and transformed into mental images (Yuille & Catcpole, 1977). Thus, the image of the company is the result of the evaluation process. A person can only have the image of a company even though he was never a consumer company. It can

happen through information obtained from various sources, such as advertising and talks with other parties.

*Consumer trust.* Rotter (1967 in Chow & Holden, 1997) described trust as ". . . an expectancy held by an individual that the words, promise, verbal or written statement of another individual or group can be relied on." In higher education context, student's confidence can be understood as student's trust to the integrity and reliability of the college. Student's trust was growing through his personal experience with the college's workers. Universities will develop the confidence as part of the relationship. A lack of trust can be badly damaging the long-term relationship between the student with the college (Andaleeb, 1992).

According to Moorman *et al.* (1992: 316), "Trust is defined as the willingness to rely on an exchange partner in whom one has confidence." The emphasis of the definition is the willingness to trust others. Trust will be realized if one party has confidence in the reliability and integrity of the partner (Morgan & Hunt, 1994; Garbarino & Johnson, 1999). Thus, trust is based on the willingness to trust the reliability and integrity of those believed.

Trust also relates to expectations, i.e. something that has not happened. It can be seen from the definition of confidence expressed by Rotter (1967 Sheth & Mittal, 2004: 371) that the trust is "a generalized expectancy held by an individual that words of another. . . can be relied on." So, trust is also related to the realization of the words of those who believed. In connection with the expected results, Anderson and Narus (1990) argue that hope includes the actions of others who provide positive results without negative results.

Sheth and Mittal (2004) also state that trust is the willingness of a person to believe in the ability, integrity, and motivation of others to serve his/her needs and interests as implicitly or explicitly approved. From the statement it can be seen that there are four things that need to be elaborated further. One, those who believe to have confidence that he will trust, have the will to do what has been approved. Two, the person belief relates to the three characteristics of partnership, namely ability, integrity, and motivation. So, it is someone judging the counterpart in terms of competence to fulfill his promise and to serve. In addition, it is a person who considers that the partner has the integrity, his words can be trusted. It is one who also believes that the partners have the motivation to take no action that is in contrary to their interests, respecting the integrity of a relationship and will act rationally. Three, people believed would keep the needs and interests of both parties, not just their own needs and interests. Four, the trusted partner will pay attention to their expectations, either explicitly or implicitly. In another statement, a partner will go beyond the mere written agreement; he will also appreciate the spirit of the agreement.

From the definitions presented above it can be seen that trust between two parties which includes the willingness to trust the other party, along with the expectations regarding the ability (reliability), integrity, and motivation parties believed to act in accordance with the agreements made so as to provide positive results to those who believe, and the fulfillment of more than what has been agreed.

*Social identification.* According to the Social Identity Theory, people tend to classify themselves and others into social categories (Tajfel & Turner, 1985 in Mael & Ashforth, 1992). According to Mael and Ashforth (1992: 104), "Social identification is the perception of belongingness to a group classification. The individual perceives him or herself as an actual or symbolic member of the group." So, it can be seen that the classification of people into social groups is based on perception. In addition, group membership can be either actual or symbolic.

Organizational identification is a special form of social identification, where a person defines himself as a member of a particular organization. If the person identifies himself with the organization, he/she perceives. ". . . oneness with or belongingness to an organization, where the individual defines him or herself in terms of the organization (s) of which he or she is a member." (Mael & Ashforth, 1992: 104)

*Image and loyalty.* According to Fishbein and Ajzen (1975 in Aydin & Özer, 2005), attitudes are functionally related to behavioral intentions, which is a predictor of behavior. The consequence is that the image of the company as attitude will affect behavioral intentions such as consumer loyalty (Johnson *et al.*, 2001: 224).

Nguyen and Leblanc (2001) also showed that the corporate image is positively related to customer loyalty in three sectors (telecommunications, retail and education). The same relation was found by Kristensen *et al.* (2000) for the Danish postal service and the food retail sector in Denmark.

Results of other studies also showed a positive and significant association between corporate image and consumer loyalty (Aydin & Özer, 2005; Nguyen & Leblanc, 2001).

Corporate image is formed in the minds of consumers through direct or indirect experience of the company. Those experiences, including through information obtained from various sources, will form an overall impression of the company, including information and experience that may be related to the physical and behavioral attributes. Overall impression or image of a company formed through a continuous process for the consumer to have the experience and information about the company. The image of company as on the company's consumer attitudes may be either positive or negative, like or dislike. The more positive image of the company means that consumers increasingly like the company. Under such a framework it can be formulated a hypothesis as follows:

H1. The image is a positive predictor for the loyalty of consumers.

*Trust and loyalty.* Trust plays an important role in influencing commitment in a relationship between consumers and companies (Morgan and Hunt, 1994) and then influencing the consumer loyalty (Gundlach & Murphy, 1993). If one party trusts the other party, the positive behavioral intentions towards the other party will be positive. If the intention was formed, then the consumer may buy the service (Lau & Lee, 1999). Trust plays a role to maintain relationship investment through cooperation, by rejecting an alternative short-term service because there are long-term benefits that are expected to persist, and by looking at potentially high-risk actions as prudent because of the belief that the partner will not act as opportunistic (Morgan & Hunt, 1994). Accordingly, several studies showed a positive association between trust in the company and consumer loyalty towards the company (Chaudhuri & Holbrook, 2001; Aydin & Özer, 2005; Lau & Lee, 1999).

There is an exchange relationship between consumers and service providers; companies provide services to consumers, and consumers pay some money for the services received. That relationship will be sustained if consumers trust the service provider. The trust includes the ability of providers to produce the same services in the future and sincerity service providers to provide the services so that consumers trust that the provider will not harm them. In such circumstances, consumers are expected to continue using the services. Under such a framework a hypothesis can be formulated as follows:

H2. Trust is a positive predictor for consumer loyalty

*Social identification and loyalty.* Social identification is the perception of members towards the group they join. The identification allows person to participate with (as if) his own achievement beyond his ability (Katz & Kahn, 1978 in Bhattacharya *et al.*, 1995).

Organizational researchers have consistently found that the identification of an organization members, such as employees and alumni, tend to increase their loyalty to the organization (Adler and Adler, 1994 in Bhattacharya *et al.*, 1995) and to decrease the exchange of workers (O'Reilly & Chatman, 1994 in Bhattacharya *et al.*, 1995). In consumer context, Sheth and Mittal (2004) state that social identification to a brand have dominant contribution for loyalty to brand.

People identify themselves socially to an organization based on his pride of the organization. Accordingly, they may have an emotional attachment to the company so that he would be willing to pass up something to support the organization. Under such a framework can be formulated hypothesis is as follows:

H3. Social identification is a positive predictor for the loyalty of consumers.

## **METHOD**

*Sample.* The subjects of this research were students at the Economics Faculty, Tarumanagara University, Indonesia, majoring in accounting and management. The sample consisted of 242 students; 142 females and 100 males, with the effective response rate of 96.5%. Their age ranged between 18 and 23 years, with 22.2 as an average.

*Measures.* This research used a self-administrated questionnaire. Image (5 items) was adapted from Bayol *et al.* (2001 in Aydin & Özer, 2005). Trust (9 items; 3 items for reliability dimension, 3 items for benevolence, and 3 items for integrity) and loyalty (4 items) scales were adapted from Sirdeshmukh *et al.*



(2002). The social identification scale (6 items) was adapted from Bhattacharya *et al.* (1995). A ten-point (Allen & Rao, 2000), modified Likert-type response format was used.

A confirmatory factor analysis with a varimax rotation was performed on all multiple scale items to determine item retention. Results of the analysis would be valid if several requirements are satisfied (see Table 2). Firstly, Bartlett's tests for all variables were significant. It means that no correlation matrixes were identity matrixes, so it was appropriate to use the analysis (Norušis, 2012). Secondly, the KMO (Kaiser-Meyer-Olkin) index was used to compare the magnitudes of the observed correlation coefficients to the magnitudes of partial correlation coefficients. KMOs for all variables were higher than 0.70, meaning that the factor analysis was appropriate (Kaiser, 1974 in Norušis, 2012).

Table 2. Prerequisites for factor analysis

Variable	KMO MSA*	Approx. Chi-Square	Sig. (Bartlett' Test)
Image	0.880	756.025	0.000
Trust	0.934	1537.564	0.000
Social identification	0.851	602.840	0.000
Loyalty	0.838	770.999	0.000

\* Kaiser-Meyer-Olkin Measure of Sampling Adequacy

Table 3 reports the results of exploratory factor analysis and reliability results. Extraction cumulative sums of squared loadings are 73.28% for image, 65.72% for trust, 67.32% for social identification and 82.17% for loyalty. All of these percentages are higher than 60.000%, so the factor for each variable was retained (Hair, Jr. *et al.*, 2006). All items loadings for each variable are higher than 0.50, except the item X20 of social identification (not shown), meaning that all 23 items may be retained (Hair, Jr. *et al.*, 2006).

Table 3. Results of factor analysis

Image (73.28*)		Trust (65.72*)		Social identification (67.32*)		Loyalty (82.17*)	
Item	Loading	Item	Loading	Item	Loading	Item	Loading
X1	0.862	X6	0.811	X15	0.746	X21	0.898
X2	0.856	X7	0.831	X16	0.860	X22	0.918
X3	0.850	X8	0.830	X17	0.823	X23	0.915
X4	0.848	X9	0.840	X18	0.852	X24	0.895
X5	0.864	X10	0.646	X19	0.816		
		X11	0.860				
		X12	0.843				
		X13	0.784				
		X14	0.831				

\* extracted cummulative squared-loading (%)

Another result of items analysis is shown on Table 4, i.e. corrected item-total correlation (CITR). CITR items for each variable are more than 0.2, meaning that all 23 items may be retained (Cronbach, 1990).

Table 4. Corrected item-total correlation (CITR)

Image		Trust		Social identification		Loyalty	
Item	CITR	Item	CITR	Item	CITR	Item	CITR
X1	0.777	X6	0.753	X15	0.618	X21	0.818
X2	0.769	X7	0.776	X16	0.767	X22	0.852
X3	0.762	X8	0.771	X17	0.712	X23	0.843
X4	0.759	X9	0.790	X18	0.751	X24	0.809
X5	0.779	X10	0.576	X19	0.703		
		X11	0.818				

		X12	0.785				
		X13	0.716				
		X14	0.775				

The reliability (Cronbach's alpha) values of all variables (see Table 5) are higher than 0.70, hence, all scales are reliable (Rust & Golombok, 1989).

Table 5. Alpha Cronbach

Variable	Alpha Cronbach
Image	0.908
Trust	0.931
Sosical identification	0.878
Loyalty	0.926

Based on the validity and reliability analysis, all instruments are appropriate to measure variables in this research.

## RESULTS

All analysis in this research is done by IBM SPSS. Table 6 provides means, standard deviations and correlations among variables. All means are between 4.00 and 4.60, the two middle points. Social identification has the maximum mean (4.60) and image has the minimum mean (4.00). The minimum standard deviation of trust is 1.047, while the maximum standard deviation of loyalty is 1.113.

The study also indicates that all correlations among variables are positive significant. The correlations range from 0.826 (between trust and loyalty) to 0.891 (between social identification and image).

Table 6. Means, standard deviations and correlations among variables

Variables	Means	Standard deviations	Correlations			
			1	2	3	4
1. Image	4.00	1.049	1.000			
2. Trust	4.22	1.047	0.869*	1.000		
3. Social identification	4.60	1.074	0.891*	0.856*	1.000	
4. Loyalty	4.25	1.113	0.848*	0.826*	0.854*	1.000

\*sign. = 0.000

Testing all hypothesis (H1, H2, and H3) was based on multiple regression analysis. The F-value is 437.358 (p = 0.000). It means that as a whole, the multiple regression model is appropriate to predict loyalty. The coefficient of determination is 0.846, meaning 84.6% of loyalty variance may be explained by variances of image, social identification and trust.

The regression model is:

$$\text{Loyalty}' = 1.001\text{E-}013 + 0.325 \text{ Image} + 0.436 \text{ Trust} + 0.207 \text{ Social identification}$$

t	0.000	6.165	7.661	3.962
Sign.	1.000	0.000	0.000	0.000

Partial regression coefficients for all three predictors are positive, as expected in the three hypothesis, and significant. The regression coefficient of image (0.325) is positive and significant (t = 6.165, sign. = 0.000), meaning that H1 is supported. The regression coefficient of trust (0.436) is positive and significant (t = 7.661, sign. = 0.000), meaning that H2 is also supported. The regression coefficient of social identification (0.962) is positive and significant (t = 3.962, sign. = 0.000), meaning that H3 is also supported.

Based on F-test and t-test, the model is appropriate to predict loyalty although the constant (1.001E-013, p = 1.000) is not significant because what is more important to predict dependent variable in regression analysis is the regression coefficients, not the constant (Aritonang R., 2007).

## DISCUSSION AND MANAGERIAL IMPLICATIONS

This research aims at developing a loyalty model in the higher education context in Indonesia and, specifically, at investigating the effects of image, trust and social identification on loyalty. By investigating the relationship between image and loyalty in the higher education context, the result endorses image as a positive and significant predictor of loyalty and some previous studies (see Sheth & Mittal, 2004; Johnson *et al.*, 2001; Nguyen & Leblanc, 2001; Kristensen *et al.*, 2000; Aydin & Özer, 2005; Aritonang R., 2014). It means that higher education institutions need to develop the institution image to build their loyalty. Building image should start before students study on campus.

This research also supports the belief that trust, as a prerequisite variable of loyalty, is a positive and significant predictor of loyalty (Gundlach & Murphy, 1993; Chaudhuri & Holbrook, 2001; Aydin & Özer, 2005; Lau & Lee, 1999; Aritonang R. 2014). It suggests that, if someone is loyal to his or her institution, he or she trusts the institution. Thus, the officials of higher education institutions should comprehensively plan every promise to students before the promises are published.

The last finding of this research is that social identification is a positive and significant predictor of loyalty and some previous studies (see Sheth & Mittal, 2004). It means that higher education institutions need to develop social identification of students with the institution to build their loyalty. Building social identification should start when students study on campus. Based on Hall and Schneider's (1972) work, membership tenure will increase identification, but the rate at which this increase occurs will diminish over time. Mael and Ashforth (1992) also report that the length of time a person is actively involved with an organization is positively related to identification. Accordingly, there are many strategies to develop social identification (Bhattacharya *et al.*, 1995).

## LIMITATIONS AND FUTURE RESEARCH

It is acknowledged that there are some limitations in the study. Firstly, the one item of social identification is not qualified. For the next research, the item should be revised, so that a conceptualization of social identification becomes representative.

Secondly, this research selected its subjects from only one university in Indonesia which, in turn, results in weakness of the external validity. A replication of the research is necessary to examine the reliability of the result because misleading conclusions could be drawn easily by the possibility of making generalizations to other countries with different characteristics (e.g. culture, academic quality). Finally, the variance of loyalty should be merged with other variables, such as quality (Hennig-Thurau *et al.*, 2001) and value (Kheiry *et al.*, 2012), motivation, and achievement in order to yield a more comprehensive model.

## REFERENCES

- Allen, Derek R. & Rao, Tanniru R. (2000). Analysis of Customer Satisfaction Data. Milwaukee, Wisconsin: ASQ Quality Press.
- Andaleeb, Syed Saad (1992). The Trust Concept: Research Issues for Channel of Distribution. Research in Marketing, 11, 1-34.
- Anderson, J. C. & Narus, J. A. (1990). A Model of Distributor Firm and Manufacturer Firm Working Partnerships. Journal of Marketing, 54 (January), 42-58.
- Aritonang R., Lerbin R. (2007). Peramalan Bisnis. Jakarta: Ghalia Indonesia.
- \_\_\_\_\_ (2014). Student Loyalty Modeling. Market (Tržište), XXVI (1), 77-91.
- Aydin, Serkan & Özer, Gökhan (2005). The Analysis of Antecedents of Customer Loyalty in the Turkish Mobile Telecommunication Market. European Journal of Marketing, 39 (7/8), 910-25.

- Barich, H. & Kotler, P. (1991). A Framework for Marketing Image Management. *Sloan Management Review*, 32 (2), 94-104.
- Bhattacharya, C. B. *et al.* (1995). Understanding the Bond Identification: An Investigation of Its Correlates among Art Museum Members. *Journal of Marketing*, 59, 46-57.
- Brown, Robert M. & Mazzarol, Timothy William (2009). The Importance of Institutional Image to Student Satisfaction and Loyalty within Higher Education. *Higher Education*, 58, 81-95.
- Chaudhuri, A. & Holbrook, M. B. (2001). The Chain Effects from Brand Trust and Brand Affect to Brand Performance: The Role of Brand Loyalty. *Journal of Marketing*, 65(April), 31-93.
- Chow, Simeon & Holden, Reed (1997). Toward an Understanding of Loyalty: The Moderating Role of Trust. *Journal of Managerial Issues*, 9 (3), 275-98.
- Cronbach, Lee J. (1990). *Essentials of Psychological Testing*. New York: HarperCollins Publishers, Inc.
- Cronin, J. J. & Taylor, S. A. (1992). Measuring Service Quality: A Reexamination and Extension. *Journal of Marketing*, 56 (3), 53-66.
- Day, G. (1969). A Two-dimensional Concept of Brand Loyalty. *Journal of Advertising Research*, 9, 29-35.
- De Wulf, K. *et al.* (2001). Investment in Consumer Relationships: A Cross-ountry and Cros-Industry Exploration. *Journal of Marketing*, 65, 33-50.
- Dick, A. S. & Basu, K. (1994). Customer Loyalty: Toward an Integrated Conceptual Framework. *Journal of the Academy of Marketing Science*, 22(2), 99-113.
- Dowling, Grahame R. & Uncles, Mark (1997). Do Customer Loyalty Programs Really Work? *Sloan Management Review*, 38(4), 71-82.
- Fornell, Claes & Wernerfelt, B. (1987). Defensive Marketing Strategy by Customer Complaint Management: A Theoretical Analysis. *Journal of Marketing Research*, 24, 337-46.
- Garbarino, Ellen & Johnson, Mark S. (1999). The Different Roles of Satisfaction, Trust, and Commitment in Consumer Relationship. *Journal of Marketing*, 63 (April), 70-87.
- Grégoire, Yany & Fisher, Robert J. (2006). The Effects of Relationship Quality on Customer Retaliation. *Market Letter*, 17, 31-46.
- Grisaffe, Doug (2001). Loyalty – Attitude, Behavior, and Good Science: A Third Take on the Neal-Brandt Debate. *Journal of Consumer Satisfaction, Dissatisfaction and Complaining Behavior*, 14, 55-9.
- Grönroos, C. (1990). Relationship Approach to Marketing in Service Contexts: The Marketing and Organisational Behavior Interface. *Journal of Business Research*, 20 (1), 3-11.
- Gulid, Nak (2011). Student Loyalty toward Master's Degree Business Administration Curriculum at Srinakharinwirot University. *American Journal of Business Education*, 4(8), 49-56.
- Gummesson, Everett (1994). Making Relationship Marketing Operational. *International Journal of Service Industrial Management*, 5 (5), 5-20.
- Gundlach, G. T. & Murphy, P. E. (1993). Ethical and Legal Foundations of Relational Marketing Exchanges. *Journal of Marketing*, 57(October), 35-46.

- Gwinner, K. P. *et al.* (1998). Relational Benefits in Service Industries: The Customer's Perspective. *Journal of Academy of Marketing Science*, 2 (2), 1001-14.
- Hair, Jr., Joseph F. , *et al.* (2006). *Multivariate Data Analysis*. Upper Saddle River, New Jersey: Prentice-Hall International, Inc.
- Hall, D. T. & Schneider, B. (1972). Correlates of Organizational Identification as a Function of Career Pattern and Organizational Type. *Administrative Science Quarterly*, 17, 340-350.
- Helgensen, Oyvind & Nettet, Erik (2007). Images, Satisfaction and Antecedents: Driver of Student Loyalty? A Case Study of Norwegian Universty College. *Corporate Reputation Review*, 10(1), 38-59.
- Hennig-Thurau, Thorsten *et al.* (2001). Modeling and Managing Student Loyalty. An Approach Based on the Concept of Relationship Quality. *Journal of Service Research*, 3 (4), 331-44.
- Jacoby, Jacob & Kyner, David B. (1973). Brand Loyalty vs. Repeat Purchasing Behavior. *Journal of Marketing Research*, 10(1), 1-9.
- Johnson, M. D. *et al.* (2001). The Evolution and Future of National Customer Satisfaction Index Models. *Journal of Economic Psychology*, 22: 217-45.
- Kheiry, Bahram *et al.* (2012). University Intellectual Image Impact on Satisfaction and Loyalty of Students (Tehran Selected Universities). *Africal Journal of Business Management*, 6(37), 10205-211.
- Kristensen, K. *et al.* (2000). Customer Satisfaction Measurement at Post Denmark: Results of Application of the European Customer Satisfaction Index Methodology. *Total Quality Management*, 11(7), 1007-15.
- Lau, G. & Lee, S. (1999). Consumers' Trust in a Brand and Link to Brand Loyalty. *Journal of Market Focused Management*, 4, 341-70.
- MacInnis, D. J. & Price, L. L. (1987). The Role of Imagery in Information Processing: Review and Extensions. *Journal of Consumer Research*, 13, 473-91.
- Mael, Frend & Ashforth, Blake E. (1992). Alumni and Their Alma Mater: A Partial Test of the Reformulated Model of Organizational Identification. *Journal of Organizational Behavior*, 13, 103-23.
- Minkiewicz, Joanna & Evans, Jody (2011). Corporate Image in the Leisure Services Sector. *Journal of Services Marketing*, 25(3),190-201.
- Mohamad, Mahadzirah & Awang, Zainudin (2009). Building Corporate Image and Securing Student Loyalty in the Malaysian Higher Learning Industry. *The Journal of International Management Studies*, 4 (1), 30-40.
- Moorman, Christine *et al.* (1992). Relationships between Providers and Users of Market Research: The Dynamics of Trust within and between Organizations. *Journal of Marketing Research*, 29 (August), 314-29.
- Morgan, R. M. & Hunt, S. D. (1994). The Commitment-trust Theory of Relationship Marketing. *Journal of Marketing*, 58(July), 20-38.
- Neal, Cathy, Pascale Quester, and Hawkins (1999). *Consumer Behavior*. New York: The McGraw-Hill Companies, Inc.

- Nguyen, N. & Leblanc, G. (2001). Corporate Image and Corporate Reputation in Customers' Retention Decisions in Services. *Journal of Retailing and Consumer Services*, 8, 227-36.
- Norušis, Marija J. (2012). IBM SPSS® Statistics 19. Statistical Procedures Companion. Chicago, IL: SPSS Inc.
- Oliver, R. L. (1997). *Satisfaction: A Behavioral Perspective on the Consumer*. New York: McGraw-Hill.
- Phadke, Suniti (2011). Modeling the Determinants of Student Loyalty in Indian Higher Education Setting. *International Conference on Management, Behavioral Sciences and Economics Issues*.
- Reichheld, F. R. (1993). Loyalty-based Management. *Harvard Business Review*, 71 (2), 64-73.
- \_\_\_\_\_ *et al.* (1990). Zero Defections: Quality Comes to Services. *Harvard Business Review*, 68(5), 105-12.
- Rojas-Mendez, Jose I *et al.* (2009). Determinants of Student Loyalty in Higher Education: A Tested Relationship Approach in Latin America. *Latin American Business Review*, 10, 21-39.
- Rust, John & Golombok, Susan (1989). *Modern Psychometrics*. London: Routledge.
- Rust *et al.* (1995). Return on Quality (ROQ): Making Service Quality Financially Accountable. *Journal of Marketing*, 59, 58-70.
- Sheth, Jagdish N. & Mittal, Banwari (2004). *Customer Behavior: A Managerial Perspective*, Australia: Thomson, South-Western.
- Shoemaker, Stowe & Bowen, John T. (2003). Commentary on 'Loyalty: A Strategic Commitment'. *Cornell Hotel and Restaurant Administration Quarterly*, October-December, 47-52.
- Sirdeshmukh, Deepak *et al.* (2002). Consumer Trust, Value, and Loyalty in Relational Exchanges. *Journal of Marketing*, 66 (January), 15-37.
- Thomas, Sam (2011). What Drives Student Loyalty in Universities: An Empirical Model from India. *International Business Research*, 4(2), 183-92.
- Wartick, Steven L. (1992). The Relationship between Intense Media Exposure and Change in Corporate Reputation. *Business and Society*, 31(1), 33-49.
- Yuille, J. C. & Catchpole, M. J. (1977). The Role of Imagery in Models of Cognition. *Journal of Mental Imagery*, 1, 171-80.
- Zeithaml, Valarie A. *et al.* (1996). The Behavioral Consequences of Service Quality. *Journal of Marketing*, 60 (April), 31-46.

## **Rent or Buy Decision at a Viscose Rayon Manufacturing Company**

**<sup>1</sup>Ians Aldian Neova & <sup>2</sup>Budi Harsanto**

<sup>1</sup>FEB Unpad Jl.Dipati Ukur 35 Bandung, ians.aldian.neova@gmail.com, +6285793347345

<sup>2</sup>FEB Unpad Jl.Dipati Ukur 35 Bandung, budi.harsanto@feb.unpad.ac.id, +628112210900

### **Abstract**

Transportation needs acquire adequate attention from the company. At manufacturing company, transportation needs are generally divided into two categories. First, to transport raw materials and or finished products. Second, as shuttle transportation for employees. This study focuses on the analysis of transportation needs for employees. The purpose of this study is to find out which one is better option to meet the transportation needs in the PT XYZ: rent or buy? This company producing semi-synthetic raw material for textile manufacturer made from cellulose fibers/viscose rayon. Current production capacity has reached 125,000 tons per year. The method used in this study is forecasting using least square, statistical test through paired samples statistics and cost analysis to compare the cost of the rent or buy decision. Components that are considered in the analysis for vehicle costs includes the vehicle price, maintenance expense, repair cost, insurance and administrative cost. As for the driver include basic salary, overtime hours and overtime rate. The results showed that the recommended decision is to buy and use internal driver with average cost of Rp 123,710,101.87 per vehicle per year.

**Keywords:** *operations management, rent or buy decisions, transportation, decision making.*

## **1 Introduction**

Every company wants its employees can contribute the maximum energy and thoughts for the betterment of the company. So that they are able to pull out the best of their abilities, they need the supports that can support their business activities. In addition to moral support, of course, need to be supported by the materials. According to Robins, Stephen P. (2009: 27), job satisfaction is the general attitude of workers who assess the difference between the amount of remuneration received by which he believed should be accepted. Meanwhile, according to Fraser, T.M. (1992: 24), the workers feel they have the perception that the rewards received as compensation for their work exceeds their energy and individual cost that has been issued, and so that the remaining compensation is still enough to undergo the necessities of life. This means that employees in a company can work with prime condition or in a state of satisfied then they need to be fulfilled in accordance with applicable standards. Job satisfaction has a positive relationship with labor productivity, as more satisfied employees work, the level of productivity achieved would be even higher.

With such an understanding, it is not surprising that employee satisfaction to be one important factor that must be considered by the company. And it became an obligation for companies to be able to achieve and maintain employee satisfaction. In addition to providing a decent salary, the company can also meet the needs of employees by providing a wide range of additional facilities, one of which is in the form of transport facilities. Transportation problems faced by companies, especially companies engaged in manufacturing is not only related to the distribution of any products. In the manufacturing, transportation needs are generally divided into two categories: 1)Transport that is used to transport raw materials or finished products. Both of suppliers as well as for distribution to consumers. 2)Transport that is used to shuttle employees both factory workers and office employees. Each of these categories has its own complexities that must be completed by the company. So that the handling of transport related to the handling of the product will be different with regard to the employee transportation. In this study, researchers focused on the problems of employees transportation procurement.

Specifically, transport for employees divided into two categories which are classified based on the transport function: a) The first category is transport that are still where the vehicle has a primary function as means to take employees to the same route every day and with a fixed schedule anyway. Typically used by employees working in the factory. While the vehicle used usually a mini bus. b) The second category is transport that are not fixed where the primary function is to facilitate the needs of the office employees and important company guest, whether for business or other purposes. In addition, the level of need is uncertain or change due to the use of this transport is conditional. For example, an employee has the type of motor vehicle, but if there will be a meeting with other companies in a location away from the company, the use of the motor is not efficient, it requires the transportation of a car to reach the location of the meeting.

Employee transportation facilities that are only used to shuttle employees only (first category), it is not experiencing a significant problem because it is fixed. As for transportation is not permanent (second category) requires further evaluation is primarily concerned with the costs incurred for the provision of transport. The current condition of the company in order to provide transport facilities employees by paying the purchase of vehicles such as cars are used as an asset by the company.

**Table 1** Vehicle in PT XYZ

<b>Type of Vehicle</b>	<b>Number of Vehicles</b>
Toyota Innova	16
Toyota Avanza	3
Toyota Previa	2
Toyota Camry	1
Toyota Wish	1
Toyota Altis	4
Toyota All New Corolla	3
Toyota Kijang LXS	2
Total	32

Source: internal company data

To meet the transportation needs, gradually the company did purchase a number of vehicles to eventually look like in table 1. During the use of this transport takes place, the company faced by various constraints, the main obstacle is the cost of overtime for drivers could exceed the amount of up to two times base salary. These costs could arise because of the working hours of the drivers are always located outside the company's working hours, so it is considered as the cost of overtime / overtime. In addition, the longer the vehicles owned by the company was only increasing in number, this also resulted in various problems of its own. Seeing these conditions, the management needs to reevaluate the issue of the provision of transport facilities employees. One option that is expected to be a solution that is by outsourcing or co-operation with third parties to meet the transportation needs of employees. In this case acts as a third party that is a company engaged in the lease/ rental car.

## 2 Literature Review

Abbas Salim (2011: 4) argued that transport is intended to move goods (cargo) and passengers from one place to another. According to Nur Nasution (2008: 104), "Transportation management is part of the activities carried out by means of transport units within the industry or trade organizations and other services for moving or transporting goods or passengers from one location to another effectively and efficiently." It can be interpreted that to be able to move or transport goods or passengers from one location to another in order to achieve effectiveness and efficiency, it takes planning and



regulation or guidance of transportation management. Transportation planning is a comprehensive plan of the "Transportation System" which is the intermode Integrated Transportation Systems.

While Matz and Usry (2006: 29) defined cost as an exchange price, a forgoing, a sacrifice made to secure benefit. In financial accounting, the forgoing or sacrifice at date of acquisition is represented by a current or future diminution in cash or other asset. According to Maurice F. Greaver II (2000 : 5) Outsourcing is the art of transferring some of a company's recurring internal activities and decisions rights to outside provider, as set forth in a contract. Because the activities are recurring and a contract is used, outsourcing goes beyond the use of consultants. As a matter of practice, not only are the activities transferred, but the factors of production and decision rights are often are, too. Factors of production are the resources that make the activities occur and include people, facilities, equipment, technology, and other assets. Decision rights are the responsibilities for making decisions over certain elements of the activities transferred. The main purpose companies outsource is to enable companies to focus on in the face of global competition and meet higher consumer demand. Through the study of management experts who conducted since 1991, including a survey of over 1200 companies, Outsourcing Institute collects a number of reasons why companies outsource to an activity and the potential benefits that are expected to be obtained from it. Potential benefits intended are: Increased focus on companies, utilizing world-class capabilities, accelerate the benefits of reengineering, divide the risk, the resources themselves can be used for other needs

### **3 Method**

This study uses descriptive-comparative method. Descriptive research is used to examine the status of a group of people, an object, a condition, a system of thought or an event that occurred in the present. Descriptive research goal is to create a description, picture or painting in a systematic, factual and accurate information on the facts, the properties and the relationship between the phenomena investigated. (Moch. Nazir 2004: 54). Comparative study is a research method to find the fundamental causal factors by analyzing the occurrence of certain phenomena (Moch. Nazir 2004: 54). In this case study variables is the same as the independent variable, but sample uses more than one or in a different time.

Analysis and the type of data that will be used in this study including research into quantitative. The data obtained are quantitative data that is then processed again based on quantitative research methodology both used simulation method and paired sample test.

There are two variables in this study. ( $X_1$ ) "The costs of transportation of employees through purchase of the vehicle" and the dependent variable ( $X_2$ ) "The costs of transportation of employees through lease to the rental car company". Through assessment, then set the following hypothesis:

$H_0$  : there is no significant difference between the cost of employees transportation procurement through buy the vehicle and costs of employees transportation procurement through rent the car.

$H_a$  : there is a significant difference between the cost of employees transportation procurement through buy the vehicle and costs of employees transportation procurement through rent the car.

## 4 Results & Discussion

Based on statistical tests were performed, shows the following results :

1. There is a difference between the cost of employees transportation procurement through vehicle purchase and lease from the car rental company.
2. There is a difference between the wage of company drivers with wage of outsourced drivers.

Then when viewed based on average mean total procurement costs of employee transportation and wages of drivers:

1. The average (mean) of the cost of employees transportation procurement through vehicle purchase = Rp. 70.530.916,73, N = 15, and standard deviation = Rp. 2.839.525,65.
2. The average (mean) of the cost of employees transportation procurement through lease from the car rental company = Rp. 86.215.602, N = 15, and standard deviation = Rp. 5.700.830,78.
3. The average (mean) wage of company drivers = Rp. 53.179.185,14, N = 15, and standard deviation = Rp. 7.054.101,48
4. The average (mean) wage of outsourced drivers = Rp. 96.573.113,33, N = 15, and standard deviation = Rp. 18.364.925,09.

Both have a similar result, the total cost incurred for the procurement of transport and total wages of drivers alike indicated that the cost for outsourcing will be more expensive than the cost of which is used internally for procurement of transport by way of purchase or hiring drivers as employees of the company .

Here is a matrix table that describes a wide variety of possible combinations of alternatives that can be used by companies and also costly in terms of provision of transport facilities for its employees.

**Table 2** Matrix Cost Average Annual Employee Transportation Procurement

	Own Driver	Outsourced Driver
Buy	123,710,101.87	167,104,030.06
Rent	139,394,787.14	182,788,715.33

Cost as result of a combination between the use of the vehicle through purchase and lease coupled with its own drivers and outsourced drivers as shown in the table 2 are as follows:

1. Purchase a vehicle with its own drivers require the average cost of RP. 123.710.101,87 annually.
2. Purchase a vehicle with outsourced drivers require the average cost of RP. 167.104.030,06 annually.
3. Rent a vehicle with its own drivers require the average cost of Rp. 139.394.787,14 annually.
4. Rent a vehicle with oursourced drivers require the average cost of Rp. 182.788.715,33 annually.

The combination can occur because at a given moment to meet the transportation needs of employees there is the possibility of vehicles owned by the company are not sufficient so we need a rental. And also there is a possibility shortage of drivers within the company that need to outsource.

According to the matrix, it can be seen that the cost of employees transportation procurement are the cheapest in the matrix 1.1 by purchasing a vehicle with its own driver. While the cost of the most expensive is the matrix 2.2 that is rental vehicle with outsourced driver.

**Table 3** The forecast for employees transportation procurement (monthly)

	<b>Buy</b>	<b>Rent</b>	<b>Own Driver</b>	<b>Outsourced Driver</b>
January 2012	89.065.607	108.366.320	69.210.261	135.730.166
January 2013	90.753.842	109.468.138	74.229.434	150.520.657

Table 3 shows that the costs required to organize employees transport facilities in the future also showed results that are not much different from the previous calculation of the cost that the cheapest remain on the purchase options and the company's own drivers.

Following reasons may explain why that outsourcing is more expensive than purchasing and internal empowerment company drivers:

1. Facility, quality and service excellence: Lease or rental is a form of cooperation with third parties in order to acquire the facility in accordance with the agreed price. Therefore, to obtain the needed facilities in the form of financial sacrifice.

Facilities provided by the tenant in this case the car rental company, include regular vehicle maintenance, insurance, vehicle latest, the administrative handling of the vehicle and so on. So naturally the price is more expensive than purchasing a vehicle which everything is taken care of by the company.

2. Drivers with high Overtime: When viewed based on the amount of basic salary driver, a cursory look that outsource driver wages are cheaper than the company driver wages. But overtime rate for outsourced drivers is higher that is ranged between Rp. 35.000,00 - Rp. 55000.00. If both are treated with the same length of time overtime, then the costs to be incurred for outsource drivers much greater, even up to three times the driver company. Gains derived by using outsourced drivers that is driving experience that is long enough, knowing the routes and important places, as well as a quiet temperament while driving. In addition, if the drivers are either absent due to illness or other things can be replaced with a substitute driver who has been provided by the car rental company. The problem here is the length of time overtime of the drivers is quite high. It can not be denied that overtime costs will inevitably arise every day considering working hours of the driver is always outside the working hours of the company. So although the basic salary of outsourced drivers is cheaper, but because of the high overtime then the costs for wages can also be higher. Conversely, if the driver overtime time is low, it is possible that the final result of total wage costs for outsourced drivers can be cheaper than the driver who works at the company.

Those are the reason why the cost of outsourcing is becoming more expensive. Therefore, from the results of the entire discussion above it can be concluded that the answer to one of the intent and purpose of the research that is "Outsourcing transport employees to third parties is not more favorable than do the employees transportation procurement that is carry out by the companies itself through vehicle purchase"

## **5 References**

- Fraser, T.M. (1992). Stres dan Kepuasan Kerja. Jakarta : Pustaka Binaman Pressindo
- Greaver, Maurice F. II. (2000). Strategic Outsourcing, a Structured Approach to Outsourcing Decision and Initiatives. USA : American Management Association.
- Nasution, M. Nur. (2008). Manajemen Transportasi. Bogor: Ghalia Indonesia.
- Nazir. Moch. (2004). Metode Penelitian. Jakarta : Ghalia Indonesia.
- Robins, Stephen P. (2009). Organizational Behavior. Eaglewood Cliff : Prentice Hall
- Sugiyono. (2007). Metode Penelitian Kuantitatif, Kualitatif, R&D. Bandung : Alfabeta
- William K. Carter & Milton F. Usry. (2006). Cost Accounting, Akuntansi Biaya, Penerbit Salemba Empat

## The Influence of Consumer's Perceived Value on Buying Behavior of Store Brands in Yogyakarta

Asmai Ishak, Drs., M.Bus., Ph.D <sup>\*)</sup>  
Meywinda Ritya Iriyanto <sup>\*\*)</sup>

### ABSTRACT

Nowdays, Store brands has become one of the most popular strategies for retailers. However, Indonesian consumers tend to perceive that store brand as inferior products in term of quality, and hence are reluctant to buy and consume them. Investigating the effect of consumer perceived value toward customers' buying behavior of store brand in Indonesia context is interesting. This study aims to examine this topic using multidimensional constructs. This research investigates the influence of involvement, loyalty, price perception, quality perception and familiarity on buying behavior using multiple regression analysis. Using a sample of 100 shoppers, the study found that involment, loyalty, price perception, quality perception and familliarly affect positively and significantly the buying behavior of store brands.

**Keyword:** *Buying Behavior, Involvement, Loyalty, Familiarity, Price Perception, Quality Perception*

### Introduction

The rapid development and competitive environments in retail industry force retailers to consider the better marketing strategy. One of most popular and critical strategy for retailers is competing on store brand products. Further, it becomes one of most popular strategy for retailers since the sales of store brand could result higher profit margin for retailers and able to compete with national brand (Permarupan et al., 2014). Harcar et al. (2006) indicate the rapid growth of store brand products in global retailers industry, and continue to expand into new markets (Baltas and Argouslidis, 2007).

AT Kearney's 2014 Global Retail Development Index (GRDI) places Indonesia in 15th position among developing countries as a retail investment destination. Further, Association of Indonesia Retailers (Aprindo) claim that the Indonesian Consumer Confidence Index, which indicates the level of optimism among Indonesian consumers is still quite high in comparison to other countries, and could drive consumption on store brand product (Dewi, 2014). This demonstrates that the situation of retail market in Indonesia is good and getting more attractive for foreign retailers. The continuing influx of world-class retailers to Indonesia indicates this. Due to the high number of retailers and the high competition of retailers in Indonesia, retail players have been trying to continuously compete and innovate on their store brand products. Several retail players in Indonesia provide their store brand products, such as Indomaret, Carrefour, Superindo, Lotte Mart, Alfamart. Providing store brand products becomes a strategy option in today modern grocery stores in Yogyakarta. Its role to attract more customers is increasing.

To win the competition, many retailers lower the price on their store brands products (Corstjens and Lal, 2000). Retailers believe that by lowering the price of their store brand products, the consumers would have more intention and preference to do shopping in their stores. Indonesian retailers position their store brand products as mid quality products with lower price to increase the buying behavior of customer, due to their belief that Indonesian customers, mostly on the mid income level, are price

-----  
<sup>\*)</sup> Senior Lecturer in Marketing Fakultas Ekonomi Universitas Islam Indonesia (asmai.ishak@uii.ac.id)

<sup>\*\*)</sup> Barchelor (S1) Student in the Management Department - the International Program UII (meywindaritya@yahoo.com)

sensitive. However, it will not be that simple. Most customers in Indonesia are still preferred to buy national brand (Nugroho and Wihandoyo, 2009). They are used to consume national brands. They also include their subjectivities such as the proudest, trust toward national brand, status and safety in the purchase decision (Fianto, and Hadiwidjojo, 2014). Additionally, their perceptions toward retail brand are quite bad compared to the national brand (AC Nielsen, 2011). They perceive the store brand products are inferior in quality compared to the national brands (Vaidyanathan and Aggrawal, 2000). This perception is the result of the low price and less familiar with the store brands. These evidences indicate that giving the lower price on store brand products is not enough to attract the customers to buy. Understanding the effect of consumer perceived value toward store brand buying behavior is an essential topic for marketers and researchers (Corstjens and Lal, 2000). However, the number of study of factors affect store brand buying behavior In Indonesia is limited (Nugroho and Wihandoyo, 2009).

Harcar et al. (2006) assert that consumer's perceived value dimensions, which consist of involvement, price perception, quality perception, familiarity and loyalty, have strongly affect buying behavior. The success of store brands is supported by the high perceived value not only by giving the lowest price of the products (Hoch and Banerji, 1993). In addition, the store brand buying preference is resulted by wider evaluation process, where quality and perceived value plays critical role (Baltas and Argouslisdis, 2007). And hence, retailers should not only consider about lowering the price but also should consider about creating good value by considering consumer's perceived values. Consumers will have buying preference if their perceived values are fulfilled (Harcar et al., 2006).

Understanding Consumer's perceived values place important part to win customers preference, and became the major motive in choosing the products. To develop and improve a product, managers must know what are the factors that consumers think when considering to purchase it. Consumer perceived values also reflect the performance of the firms in delivering their products (Sweeney and Soutar, 2001). Empirical findings demonstrate that consumer's perceived value dimensions contribute positively to their perceptions of store brands. Better knowledge on the aspects of store brand products due to their past experience in purchasing the items lead to positive perceptions which eventually will lead to good possibility for them in re-purchasing store brands products in the future (Permarupan et al., 2014). This research investigates factors influencing consumer's buying behavior of store brands within the Indonesia context, especially in Yogyakarta. Specifically, this research investigate how perceive value dimensions which are; involvement, loyalty, price perception, quality perception, and familiarity, affect consumer buying behavior of store brands.

## **Literature Review and Hypotheses Development**

### **Consumer Buying Behavior**

Buying behavior is defined as the process by which individual search, select, purchase use and dispose good and services, in satisfyinghis/her need and want. Consumer buying behavior can be viewed as signal of retention of defection toward the product (Permarupan et al., 2014). The knowledge of consumer behavior helps marketers to understand how consumers think, feel and select the alternatives of products, brands and the like, and how their environment, the reference groups, family, and salespersons influence them (Furajji et al., 2012).

Previous studies of consumer buying behavior mostly investigated personal factor, social factor, physical factors, cultural factors, and attitudinal factors. While Kotler & Caslione (2009) stated that consumer buying behavior is affected by physiological factor, cultural factor, personal and social factors, there had been limited studies examine physiological factors (motivation, perception, belief, attitude) as the antecedence variables (Yakup et al., 2011). Perception is one of major in physiological factors. It is the process by which people select, organize, and interpret information to form a meaningful picture of the world (Kotler & Caslione, 2009). Consumer's perceived value contributes positively to perceptions of store brands and the greater knowledge of store brands (mostly due to consumer's previous experience), and leads to positive perception, which in return contributes positively to store brand purchase (Harcar et al., 2006). In studyingthe consumer perceived value and the buying behavior of TESCO's store brands, Permarupan et al. (2014) examine

the loyalty, the price perception, the quality, and the familiarity. The results indicate that only the familiarity and the quality perception have significant effect on buying behavior. Other research results indicate that buying behavior of store brands is affected by involvement (Zeb et al., 2011), loyalty (Hesket, 2002), price perception, quality perception (Rzem & Debabi, 2012), and familiarity (Flavian et al., 2005).

## **Perceived Value**

Consumer perceived value has become the fundamental issue to be addressed in every marketing activity (Rzem & Debabi, 2012). Perceived value was firstly introduced by Monroe and Krishnan who have proposed that whether consumers make a purchase or not would depend on the correlation between the gains they get from the product they want to buy and the cost they pay for it. The more perceived gains exceed the perceived cost, the higher the consumers' perceived value (Peng & Liang, 2013). This is consistent with Payne & Holt (2001) who stated that perceived value implies a trade-off between benefits and sacrifice.

The perceived value has been examined by various researchers as a factor that has a great influence on the decision-making process of customers. The strong effect on perceived value on buying behavior has driven great interest of the researcher. As stated by Petrick (2002) high levels of perceived value result in purchase. Despite of the huge interest on the study about the perceived value, the concept of perceived value has not been clearly defined in studies of the subject (Khalifa, 2004). Besides the definitions of perceived value stated by Payne & Holt (2001), there are many definitions of perceived values that have been claimed by other researchers. Fernandez and Bonillo (2007) believed that perceived value is defined as the outcome of an evaluative judgment, whereas the term values refers to the standards, rules, criteria, norms, goals, or ideals that serve as the basis for such an evaluative judgment. Further, Kotler and Armstrong (2007, p.622) stated that consumer perceived value is whether the price is reasonable in relationship to value.

Even though various definitions of perceived value have been offered in the marketing literature, one of the most commonly cited definitions is that supplied by Zeithaml (1988), who defines the perceived value as the consumer's overall assessment of the utility of a product based on perceptions of what is received and what is given. This view places the perceived value as a uni-dimensional construct that can be measured simply by asking respondents to rate the value that they received in making their purchases. However, other studies presume such conceptualization represents a narrow approach (Permarupan et al. 2014). Sweeney & Soutar (2001) argue that the perceived value is a multidimensional construct in which the dimensions are price, quality, emotional, and social. Many studies investigate the multidimensional construct of the perceived value and its effect on the consumer buying behavior (Sheth et al., 1991; Petrick, 2002; Harcar et al., 2006; Sanchez et al., 2006; Peng & Liang, 2013; Permarupan et al., 2014). However, these research do not only demonstrate different results but also use different dimensions in measuring the perceived value. For instance, Sanchez et al. (2006) use six dimensions, while Peng & Liang (2013) only consider four dimensions to measure the construct.

Nevertheless, those researches demonstrate that the perceived value is not one-off phenomenon; rather, it must be seen as an ongoing assessment within an evolving consumer relationship (Fernandez & Bonillo, 2007). Instead of the inconsistent finding and theory used in the studies of perceived value, the study of perceived value and consumer buying behavior is mostly conducted in developed countries. This lack of agreement among scholars with respect to the conceptualization and measurement of perceived value is a consequence of its somewhat nebulous nature, which has variously been described as complex (Lapierre, 2000). In responding to this concern, this study investigates consumer perceived value by adopting the previous research done by Harcar et al. (2006) and Permarupan et al. (2012). This study examines the perceived value using a multi-dimensional construct, which consists of involvement, quality perception, price perception, brand loyalty, and familiarity. The following sections present the detail discussion of each dimension.

## **Involvement**

Involvement is defined as a psychological state that motivates people to be more aware and careful about persons/objects/situations. It also indicates a level of personal importance that the person attaches to such persons/objects/situations (Praveen, 2011). In line with Praveen, Sahney (2013) asserts that the consumer involvement is a state of mind that motivates consumers to identify the product offerings, their consumption patterns, and consumption behavior. Involvement creates



desire or encouragement within customers to look for and think about the product category and the varying options before making decisions on brand preferences and the final act of purchase. It is the amount of physical and mental effort that consumer puts before purchase decision. It creates within a person a level of relevance or personal importance to the product offering, and leads to an urge within the former to collect and interpret information for present or future decision-making (Sahney, 2013). Schiffman & Kanuk (2007) states, further, that the involvement is a heightened state of awareness that motivates consumers to seek and think about product information before the purchase. It is the perceived interest and importance that a consumer attaches to the consumptions of products.

There has been several researches that investigated how the involvement relates to the consumer behavior in buying decision processes (Gendel & Levy, 2013). The consumer involvement influences the consumers' attitudes, and motivates the buying behavior in the consumption activities (Celsi & Olson, 1988). In the study of Sahney (2013), it was found that involvement affects the consumer buying process and the sub processes of information search, information processing, and information transmission. The effect of Involvement of consumers on buying behavior, when making purchase decisions, varies across persons, across product offerings in question as well as purchase situations and time at hand (Praveen, 2011). However, previous research findings demonstrate inconsistent effect of the involvement on the consumer buying behavior. In studying the involvement in edible oil, Pragma & Nalendra (2011) find that if customers are highly involved in the purchase decision, they would choose the brand carefully and repeatedly. Zeb et al, (2011), studying female consumer buying behavior in fashion clothing, claim that the involvement was highly related to the customer buying behavior indicated by the changing of their confidence and intention in making purchase decision. This study demonstrate that the higher the customer involvement in fashion clothing, the higher the confidence and intention to purchase are. Harcar et al. (2006) suggest that involvement as one of perceived value dimensions affecting customer-buying behavior by shifting the consumer value perception. Consequently, the higher the involvement, the more information kept by the customer. Having better information encourages customers to perceived value in a brand, and feels attached to the brand which in turn change their purchase behavioral (Kos & Vida, 2004).

While the previous research above showed the strong positive relationship between the involvement and the buying behavior (Zeb et al., 2011), empirical studies examined the involvement in grocery products show different results. Gendel and Levy (2013), for example, uncover that the influence of the customer involvement on the willingness and intention to buy store brand is low, slightly marginal, and indirect. George & Edward (2009) examine the cognitive dissonance and the purchase involvement in consumer behavior, find that the customer involvement do not have strong positive relationship to the buying behavior. Their research results indicate that the involvement has stronger influence on the cognitive dissonance.

Besides the inconsistent results shown in the previous researches, the results of those studies can not be generalized to all products, because different products have different level of importance for the customers (Pragma & Nalendra, 2011). Apart from the inconsistent result of the studies, Zaichkowsky (1985) states that highly involved customers are less open to alternative views and tend to be difficult to be persuaded through advertising. They tend to believe on products information available on the label, package, and ingredients (Rundle-Thiele & Bennett, 2011). Hence, the involvement of customers positively affect on how consumers decision making and buying behaviors (Michaelidou & Dibb, 2008). Based on the above discussion, the hypothesis proposed in this research is:

*H<sub>1</sub>: Involvement positively affects consumer buying behavior of store brands.*

## **Loyalty**

Customer loyalty is all about attracting the right customer, getting them to buy, buying often, buying in higher quantities, and bringing a seller even more customers. To build customer loyalty, customer experience management blends the physical, emotional and value elements of an experience into one cohesive experience. Retaining customers is less expensive than acquiring new ones and customer experience management is the most cost-effective way to drive customer loyalty (Permarupan et al., 2014). Wieringa & Verhoef, (2007) describe the loyalty as an unspecified number of repeat purchase from the same supplier over a specified period. Kharaim (2011) believe that the loyalty is closely associated with many factors. One of them is being the experience of using the product. The other factor that makes customer loyal is because of high switching barriers related to technical, economical, or psychological factors.



Heskett (2002) investigates that the loyalty is one of indicators of customer's perceived value that influences the buying behavior. He find that the consumer loyalty is able to identify the degree of benefit perceived by the customer and can classify as added value, which can influence customer buying behavior. The effect of the customer loyalty on the buying behavior is shown in the repeat purchase and willingness to recommend others. The positive impact of customer loyalty is also shown in a research by Fouladivanda et al. (2013) who investigate the effect of brand equity in consumer buying behavior in the fast moving consumer goods. The result of the study reveal that the loyalty has the highest impact on consumer buying behavior compared to brand awareness and brand association. The significant effect of the customer loyalty on the customers buying behavior is also shown in the research done by Nazia (2011), investigating about Loyalty on L'oreal and Garnier products. It is stated that the loyalty affect buying behavior, which determined the intention to purchase. However, the respondents of the research were limited only to retailers. Therefore, it is only the retailer's point of view which can not be generalized.

In contrast to the research findings that the customer loyalty influences positively the buying behavior, Shukla (2009) believes that in purchasing grocery products, customers do not buy products because of their loyalty on one particular brand. The reason is that grocery products are daily consumed products which are low risk, and categorized as fast moving products. The consumers are more concerned about the package, information provided in the package, price, and the trade off between price and quality (Rzem & Debabi, 2012). Therefore the loyalty do not significantly affect the buying behavior. However, this research can not be generalized because the sample was limited to young customers.

Apart from the previous studies demonstrate inconsistent results; yet, most of them find that the loyalty positively affect the consumer buying behavior. Based on this consideration, the hypothesis proposed in this research is:

*H<sub>2</sub>: Consumer loyalty positively affects consumer buying behavior of store brand.*

## **Price Perception**

The price of a product or service is what the customer pays for obtaining it. Price is also defined as the agreed value placed on the exchange by a buyer and seller (Weckman, 2009). However, Ghayoomi & Nazari (2014) suggest that there are two kinds of price, i.e. subjective and objective prices. Price is normally "objective" figure because price is certain amount of money. Marketers are going by perception, treat price as much as subjective as an objective measure. Price can be defined as consumer judgments of price fairness in terms of consumers' relationships with sellers (Martins & Monroe, 1994). Price perception as subjective price is critical for marketers (Nazari & Ghayoomi, 2014). Since it is critical for marketers, they should work it out carefully, because the studies on the price perceptions has produced some contradicting findings (Ho, 2012).

In the study about the price perception on mobile communication service, Munnuka (2008) reveals that there is significant positive relationship between customer's perception on the price and the purchase intention. This finding strengthens the study of Grewal et al., (1998) who find the the price perception has a moderately significant effect on buyers' perception and purchase intention. Supporting Munnuka (2008), Rajput et al. (2012) and Ghayoomi & Nazari (2014) uncover the positive effect of the price perception on the customer buying behavior. Hao (2011) believes that the changing in price perception changes the buying behavior due to the discount program. Interestingly, the effect of the price perception on the buying behavior is different for customers from different countries. The study of Jin & Sternquist (2003) investigate about the price perception of US and Korean students. The results indicate that the price perception has low influence on the buying behavior for Korean students. They explain that Korean students are more sensitive to quality rather than prestige and word of mouth. Prestige and word of mouth may result price perception beyond the objective price/ actual price. Korean students are also less hedonistic shopping tendency. Thus, it caused the low influence of their price perception on buying behavior. In contrast, the price perception of US students strongly influences the buying behavior. US students are more price sensitive.

Many consumers are not looking for the lowest prices. Store brands with the low price are not enough in influencing consumer on their purchase decisions (Permarupan et al., 2014). They are looking for a store that offers a number of other benefits besides low prices. If the product adds great value, price becomes less important (Moon et al., 2006). Dodds (1991) in studying the price and the store name in retail industry find that the intention to buy is mostly caused by the performance of store image. Thus, the store image is considered as a good value for the customers. The findings also reveal that the

price perception has less influence on the buying behavior compared to the store image. Similarly, the study of Permarupan et al. (2014), that use the multiple regression analysis, suggest that the price perception has low influence on the buying behavior.

Based on the above discussion, the hypothesis proposed in this research is:

*H<sub>3</sub>: Consumer price perception has positive effect of store brand buying behavior.*

## **Quality Perception**

As businesses competition becomes intense, the concept of the quality perception has been increasingly becoming much on the minds of marketing practitioners today (Zeithaml, 1988). Kirmani & Baumgartner (2000) believe that the quality perception is the evaluation of brand benefits perceived by consumers, which will easily lead to deviation from perceived quality to objective quality. This is consistent with Zeithaml (1988) who states the perceived quality is the consumer's judgment about a product's overall excellence or superiority. Zeithaml (1988) emphasizes that the perceived quality is (1) different from objective or actual quality, (2) a higher-level abstraction rather than a specific attribute of a product, (3) a global assessment that in some cases resembles attitude, and (4) a judgment that is usually made within a consumer's evoked set.

According to Bao et al. (2011), customer's quality perception is a significant determinant of store brand's success, and found to have substantial impact on store brands purchase intention. In the research on the buying behavior and the perceived value of TESCO's customers, Permarupan et al. (2014) reveal that the quality perception significantly and positively affect the buying behavior of store brands. The quality perception is regarded as one of the most relevant variables when explaining the difference between the customer purchase behavior of store brands and national brands (Mieres et al., 2006). In line with this argument, Delong et al. (2004) and Baltas & Argouslidis (2007) note that the quality perception has significant role in store brand preferences and buying behavior.

Vantamy (2007) suggested that consumer's quality perception is the consumer's way of measuring level of benefits perceived. Thus, the higher the benefit felt by the customers, the more the customers are encouraged to buy. The quality perception is the antecedence of consumer buying behavior because it determined the willingness and intention to buy. Similar to Vantamy (2007), Alex and Thomas (2011) investigate the coffee shop buying behavior. They find that the customers quality perception toward the service, the taste of the coffee, and the coffee shop convenience positively influence customer's buying behavior. The quality perception does not only influence customer's buying behavior at the pre purchase phase but also affects the behavior at the post purchase phase (Parasuraman & Grewal, 2000)

The role of perceived quality in influencing consumer choice and behavior is well supported. Based on Baltas (2003), consumer preferences result from a process of evaluation in which the quality has the most significant role on the buying process. For instance, in the study examined about drugstores as the research context, Wu (2011) demonstrates that the service quality has a positive effect on the purchase intention of store brands. Huang & Hsieh (2011) also discover that the higher perceived quality, the more positive behavior in purchasing store brand food products among Taiwanese consumers. Hence, private label buyers observe that the brands have a good perceived quality. In contrast to these findings, Cheng et al. (2014) uncover that that customers have low evaluation on the quality of Chinese local retailers' store brands. Similarly, Rajput et al. (2012) who study the impact of price perception and quality perception in Pakistan customers, find that the quality perception has negative impact on the buying behavior. They explain that it is because most Pakistan customers have low-income, and make them prefer low price products.

Consistent with the most research findings that demonstrate a significant influence of the quality perception on the buying behavior, the hypothesis proposed in this research is:

*H<sub>4</sub>: Quality perception positively affects consumer-buying behavior of store brand.*

## **Familiarity**

Consumer familiarity with a product or service has become the interest of marketing researchers because the familiarity can play a critical role on consumer decision-making process (Densai & Hoyer, 2000; Fen et al., 2012). Consumer familiarity is a result of accumulated consumer learning of a brand either through consumption experience or through marketing communications. The familiarity usually depends on the number of experience related to a product that has been accumulated by customers.

As consumers use product more frequently, they are more familiar with it. This can reduce uncertainty in future purchase situation (Flavian et al., 2005). As noted earlier, familiarity provides the customer with different frame of reference for evaluations in the buying process. Moreover, familiarity has been proven one of the most relevant determinants when explaining the difference between store brands and national brands consumers' buying behavior (Mieres et al., 2006).

In the context of store brands that are characterized as inexpensive and frequently purchased, the role of familiarity becomes more significant in influencing consumer buying behavior. Familiarity reflects a consumer's understanding of a product and the amount of information available to the consumer which he or she judges to be important in evaluating product quality (Baltas & Argouslidis, 2007). In general, consumers who possess greater familiarity with a specific product category are more likely to remember the information better (Alba & Hutchinson, 1987). This situation may lead to favorable brand evaluations and quality perception (Hardesty et al., 2002). Permarupan et al. (2014) corroborate this point of view by demonstrating significant effect of the familiarity on the buying behavior through their study of TESCO customers in Malaysia. They reveal that the familiarity has the highest positive significant influence on the buying behavior compared to the loyalty and the price perception. This is consistent with the study of Harcar et al. (2006) who find that the familiarity positively contribute to the customers perception, and significantly influence the buying behavior. The positive effect of familiarity toward buying behavior is also shown in the study of Ha & Jang (2010) who examined familiarity in restaurant context. By the purpose of examining the moderating effect of brand familiarity on satisfaction evaluation and customer buying behavior, they assert that the familiarity influence the effect of the satisfaction on the buying behavior. They further explain that the effect of the satisfaction on the buying behavior is stronger for customers who have high familiarity.

However, Stranahan & Konsiel (2007), who examine familiarity on online shopping, find contradictory finding. Their study indicates that the familiarity does not affect the buying behavior of young and educated customers when shopping online. Younger and educated customers are willing to purchase unfamiliar brand on unfamiliar online store.

Based on the above discussion, the hypothesis proposed in this research is:

*H<sub>5</sub>: Familiarity positively affects consumer-buying behavior of store brand*

## Research Method

The sample used for this study are the people who live in Yogyakarta, and have experiences of buying store brands. The sample selection use non-probability random sampling method with convenient approach, The survey conducted with face-to-face guidance of the questionnaire. From 113 respondents involved in this study, only 100 questionnaires considered in the analysis. 15 questionnaires removed from the the study due to incompleteness of the answers.

The constructs of this study i.e. Consumer Buying Behavior, Involvement, Loyalty, Price Perception, Quality Perception, and Familiarity were measured adapted from Harcar et al. (2006). A six point Likert-type scale was anchored with "strongly disagree" (1) and "strongly agree" (6) across all measures. Minor modifications to some item semantic were made on the basis of pre-test that was held in order to more accurately reflect the context of this research. Based the pre-test questionnaires on 35 respondents, all items are valid in measuring the constructs. Their corrected item-total correlations are ranging from 0.332 to 0.785 with Cronbach alpha ranging from 0.638 for Familiarity to 0.888 for Involvement indicating that all constructs are reliable. These 35 questionnaires were not included in further analyses. Table 1. Below presents the detail of the pre-test questionnaires.

**Table 1: Validity and Reliability Tests for the Questionnaire**

Constructs/Indicator	Corrected Item-Total Correlation	Cronbach Alpha	Minimal Score	Status
<b><i>Involvement</i></b>		0.888	0.6	Reliable
Having expertise on shopping	0.684		0.3	Valid
Being good source of shopping	0.785		0.3	Valid
Buying product that perceived as important	0.678		0.3	Valid
Buying product that matters a lot for him/her	0.755		0.3	Valid
Buying product that interest him/her a lot	0.746		0.3	Valid
Enjoying and being able to give advice to other people when it comes to shopping	0.471		0.3	Valid

Reading product labels in detail before buying	0.682		0.3	Valid
<b>Loyalty</b>		0.686	0.6	Reliable
Having preference on a specific brand when buying product	0.366		0.3	Valid
Always asking for his/her favorite product	0.480		0.3	Valid
Having a lot of attention about which particular brand s/he buys	0.521		0.3	Valid
Having preference to always shop at one store	0.529		0.3	Valid
<b>Price Perception</b>		0.650	0.6	Reliable
Believe that the price of store brands offer great value for money	0.499		0.3	Valid
Believe that store brand products appear to be bargain	0.461		0.3	Valid
Believe that price and quality show positive relationship	0.332		0.3	Valid
Believe that s/he gets the quality that paid for store brands	0.387		0.3	Valid
Think that store brand products are considered to be good to buy	0.348		0.3	Valid
<b>Quality Perception</b>		0.866	0.6	Reliable
Perceive that all brands of grocery products are basically the same in quality	0.778		0.3	Valid
Think that there are no significant differences among different brand of grocery products in term of quality	0.530		0.3	Valid
Think that store brand grocery products do not vary a lot in term of quality	0.753		0.3	Valid
Believe that there are only minor variations among brands of grocery products	0.747		0.3	Valid
Believe that there is a great deal of difference in overall quality between nationally advertised and store brand grocery items	0.651		0.3	Valid
<b>Familiarity</b>		0.638	0.6	Reliable
Buying store brands	0.384		0.3	Valid
The shopping cart contains store brand for several products	0.537		0.3	Valid
Familiarity with various store brand grocery items available in grocery store	0.449		0.3	Valid
<b>Buying Behavior</b>		0.853	0.6	Reliable
Have intention to buy store brand product	0.683		0.3	Valid
Have willingness to buy store brand in the future	0.723		0.3	Valid
Have willingness to give recommendation to buy store brand to her/his relatives	0.781		0.3	Valid

## Results and Discussion

From 100 respondents involved in this study, 57 % of them are female, while the rest are male. Most of the respondents (67%) are 20-50 year old. Nearly a quarter of them are below 20 year old, and the rest are above 50 years. In term of the occupation, nearly half of the respondents (48%) are students, 30% work in the private and public organization. Whereas the rest are house wife or business people. Validity and reliability tests were conducted to ensure that the data used this study used are good. The results of these tests are presented in the Table 2 below:

**Table 2: Validity and Reliability Tests for the Data**

Constructs/Indicator	Corrected Item-Total Correlation	Cronbach Alpha	Minimal Score	Status
----------------------	----------------------------------	----------------	---------------	--------

<b>Involvement</b>		0.885	0.6	Reliable
Having expertise on shopping	0.747		0.3	Valid
Being good source of shopping	0.686		0.3	Valid
Buying product that perceived as important	0.699		0.3	Valid
Buying product that matters a lot for him/her	0.683		0.3	Valid
Buying product that interest him/her a lot	0.767		0.3	Valid
Enjoying and being able to give advice to other people when it comes to shopping	0.592		0.3	Valid
Reading product labels in detail before buying	0.560		0.3	Valid
<b>Loyalty</b>		0.828	0.6	Reliable
Having preference on a specific brand when buying product	0.577		0.3	Valid
Always asking for his/her favorite product	0.740		0.3	Valid
Having a lot of attention about which particular brand s/he buys	0.706		0.3	Valid
Having preference to always shop at one store	0.602		0.3	Valid
<b>Price Perception</b>		0.772	0.6	Reliable
Believe that the price of store brands offer great value for money	0.595		0.3	Valid
Believe that store brand products appear to be bargain	0.618		0.3	Valid
Believe that price and quality show positive relationship	0.526		0.3	Valid
Believe that s/he gets the quality that paid for store brands	0.635		0.3	Valid
Think that store brand products are considered to be good to buy	0.348		0.3	Valid
<b>Quality Perception</b>		0.848	0.6	Reliable
Perceive that all brands of grocery products are basically the same in quality	0.741		0.3	Valid
Think that there are no significant differences among different brand of grocery products in term of quality	0.694		0.3	Valid
Think that store brand grocery products do not vary a lot in term of quality	0.640		0.3	Valid
Believe that there are only minor variations among brands of grocery products	0.645		0.3	Valid
Believe that there is a great deal of difference in overall quality between nationally advertised and store brand grocery items	0.575		0.3	Valid
<b>Familiarity</b>		0.743	0.6	Reliable
Buying store brands	0.571		0.3	Valid
The shopping cart contains store brand for several products	0.616		0.3	Valid
Familiarity with various store brand grocery items available in grocery store	0.523		0.3	Valid
<b>Buying Behavior</b>		0.852	0.6	Reliable
Have intention to buy store brand product	0.665		0.3	Valid
Have willingness to buy store brand in the future	0.726		0.3	Valid
Have willingness to give recommendation to buy store brand to her/his relatives	0.785		0.3	Valid

The data in Table 1 above demonstrate that all items and constructs are considered to be valid and reliable. This is indicated by the score of corrected item-total correlations that are above the minimum score (0.30) and the Cronbach Alpha which are also greater than the minimum score of 0.6.

Furthermore, tests of multicollinearity, normality, and heteroscedasticity are also conducted to verify that the data fulfill the requirements of the multiple regression used for the analysis. The results of



those tests demonstrate that there is no multicollinearity in the data indicated by the values of VIF lower than 10; the data are normal shown by the probability of residual regression of 0.999 which is greater than 0.05; and the residual plot is speeded upper and under 0 point, and it does not shape any pattern such as U pattern or U rolled back. It illustrates the difference in the data that meets the assumption homocedasticity. These test results indicate that the data fulfill the requirements, and readily examine the research hypotheses.

The results of multiple regression demonstrate that the model of this research is a good model. F value of 30.115 with significant level of 0.000 indicate this, meaning that all the independent variables of this study simultaneously affect the dependent one. Those independent variables can explain the variance of the independent as much as 59.5%, while the rest of variances are explained by other variables not included in this study. The value of adjusted R<sup>2</sup> of 0.595 points out this evidence. Additionally, Table 3 below summarizes further results of the multiple regression analysis with regard to the  $\beta$  and t values, their relationships with hypotheses of this study:

**Table 3: Summary of  $\beta$  and t Values, and Hypotheses**

Hypothesis	$\beta$ (t Value and Sig. Level)	Status
H <sub>1</sub> : Involvement positively affects consumer buying behavior of store brands	0.24 (2.58/0.011)	Supported
H <sub>2</sub> : Consumer loyalty positively affects consumer buying behavior of store brand	0.17 (2.01/0.05)	Supported
H <sub>3</sub> : Consumer price perception has positive effect of store brand buying behavior	0.23 (2.59/0.01)	Supported
H <sub>4</sub> : Quality perception positively affects consumer-buying behavior of store brand	0.18 (2.17/0.03)	Supported
H <sub>5</sub> : Familiarity positively affects consumer-buying behavior of store brand	0.18 (2.21/0.03)	Supported

Table 2 above demonstrates that all independent variables (the Involvement, the Loyalty, the Price Perception, the Quality Perception, and the Familiarity) significantly and positively affect the dependent variable (Buying Behavior). Their  $\beta$  values are ranging from 0.17 to 0.24; with t values greater than 1.96 and the significant level lower than 0.05. These values prove that all hypotheses of this study are supported.

This study corroborates previous research such as Zaichkowsky (1985), Harcar et al. (2006), Pragma and Nalendra (2011), and Zeb et al. (2011) who find that the involvement influences the consumer buying behavior. This implies when consumer involve in the purchase decision making, they will have more information, which in turn leads them to have good perception toward the brand, and feels attached to it, and finally encourage them to buy. Moreover, the study also amplifies the empirical findings of Heskett (2002), Harcar et al. (2006), Nazia et al. (2011), Fouladivanda et al. (2013), and Permarupan et al., (2014) which reveal that the consumer loyal to a certain brand because they feel some benefit from it. When they are loyal to the brand they will continuously consume it, and more importantly they will inform others about the brand.

Likewise, this study is consistent with the previous study such as Grewal et al., (1998), Harcar et al. (2006), Munnuka (2008), Rajput et al. (2012), Ghayoomi and Nazari (2014), and Permarupan et al., (2014) who declare the price perception have a positive effect on the consumer buying behavior. This suggests that consumers consider the price when purchasing products. Nevertheless, marketers should be careful in determining the price because this does not mean that consumers are price sensitive. As stated earlier in the previous section that lower price cannot always encourage consumers to buy. Setting the price too low can make the consumer presume the product to have low quality. They, sometimes, look for a number of other benefits besides low price. Marketers should realize that consumers also consider the store reputation in doing their shopping. Setting the price is not a simple decision but it is a complex and complicated decision making.

Additionally, this study demonstrates that the consumers perceive quality affects positively their buying behavior. This amplifies previous research such as Delong et al. (2004), Harcar et al. (2006), Mieres et al., (2006), Baltas and Argouslidis (2007), Bao et al., (2011), and Permarupan et al. (2014). Empirical findings reveal that consumers use the quality as the relevant indicator to differentiate the

store brands and the national ones. This could be one of the explanations of why the quality perception has a significant role in enhancing the store brand preferences and buying behavior. Finally, this study is in line with the findings of Flavian et al., (2005), Harcar et al (2006), Mieres et al., (2006), Fen et al., (2012), and Permarupan et al (2014) revealing that the has positive effect on the consumer buying behavior. This suggest the more familiar consumers with the brand the higher the possibility consumers to buy the brand will be. When consumers are familiar with the brand, this reduces their uncertainty in buying it in the future.

## Conclusions and Implications of the Study

Based on the aboe analyses, the conceptual framework of this study, statistically, is good. All dimensions of the consumers perceived value considered in this study are good predictors of the consumers buying behavior. Those dimensions have significantly and positively influence the buying behaviors either partially or simultaneously. Consequently, all hypotheses of this study are supported. The findings of this study can give a clear picture for marketing practionaires, especially operating in the retail industry that the customer preceived values have an important role in changing the consumer buying behavior. They should put more attention the perceived value dimension, specifically the consumer involvement, loyalty, price perception, quality perceptions, and familiarity when formulating their marketing strategy. They should explore these dimensions in more detail so that the formulated strategy really fit to the percieved values of the target consumers.

However, considering the independent variables of this study is only able to explain 59,5% variance of the consumer buying behavior, future research should include other variables to increase predictive power the behavior such as the store reputation/image, the variety of the store brands availability and the like. Or alternative the future research should include the specialty storesto detect any differentiation with the grocery ones. By doing so researchers can predict the generalizability of the model.

## References

- ACNielsen.(2011). *9<sup>th</sup> Annual Frequent Shopper Survey*. Retrieved from: <http://www2.acnielsen.com>.
- Alba, J.W., and Hutchinson, J.W. (1987). Dimensions of consumer expertise. *Journal of Consumer Research*, 13, 411-454.
- Alex, D., and Thomas, S. (2011). Impact of product quality, service quality, and contextual experience on consumer perceived value and future buying intention. *European Journal of Business*, 3(3).
- Baltas, G., and Argouslidis, P. C. (2007). Consumer characteristics and demand for store brands. *International Journal of Retail and Distribution Management*. 35(5), 328-241.
- Baltas. G., (2003). A combined segmentation and demand model for store brands. *European Journal of Marketing*, 37, 1499- 1514.
- Bao, Y., Shibin S.,Yeqing, B., and David, S. (2011). Assessing quality perception of private labels: Intransient cues and consumer characteristics. *Journal of Consumer Marketing*, 28(6), 448 – 458.
- Celsi, R.L. and Olson, J.C. (1988). The role of involvement in attention and comprehension processed. *Journal of Consumer Research*, 15 (2), 210-224..
- Cheng,H., Li, D., and Luo, L. (2014). The Chinese perception of quality: Model building and analysis based on consumers perception. *Journal of Chinese Management*, 1(3).
- Corstjens, M., and Lal, R. (2000). Building store loyalty through store brands. *Journal of Marketing Research*, 37, 281-291.
- Delong, M., Bao, M., Wu, J., Chao, H., and Li, M. (2004). Perception of US branded apparel in Shanghai. *Journal of Fashion Marketing and Management*, 8(2), 141–153.
- Densai, K.K., and Hoyer W.D. (2000). Descriptive characteristic of memory based consideration sets: Influence of usage occasion frequency and usage location familiarity. *Journal Consumer Research*, 27, 209-323.
- Dewi, N. K. (2014). Retail overview: huge opportunity amid tight competition. Jakarta Post. Retrieved from <http://www.thejakartapost.com/news/2014/10/29/analysis-retail-overview-huge-opportunity-amid-tight-competition.html>
- Dodds, W.B. (1991). In Search of value: How price and store name information influence buyers' product perception. *The Journal of Service Marketing; Summer*, 5(3), 27.

- Fen, S., May, S., Yu-Ghee, L, and Wee. (2012). Store brand proneness: Effect of perceived risk, quality and familiarity. *Australian Marketing Journal*, 20(1), 48-58.
- Fernandez, R. S., and Bonillo, M. A. I. (2007). The concept of perceived value: A systematic review of the research. *Marketing Theory*, 7, 427.
- Flavian, C., Gunaliu, M., and Torres, E. (2005). The influence of corporate image on consumer trust: A comparative in traditional versus internet banking. *Journal of Internet Research*, 15, 447-470.
- Fouladvanda, F., Pashandi, M.A., Hooman, A., and Khanmohammadi, Z. (2013). The effect of brand equity on consumer buying behavior in term of FMCG in Iran. *Interdisciplinary Journal of Contemporary Research in Business*, 4(9).
- Furajji, F., Łatuszyńska, M., and Wawrzyniak, A. (2012). An empirical study of the factors influencing consumer behavior in the electric appliances market. *Contemporary Economics*, 6, 76-86.
- Gendel, G.G and Levy, S. (2013). Does consumers' personal involvement have an influence in store buying proneness? *Journal of Service Marketing*, 30 (7).
- George, B. P., and Edward, M. (2009). Cognitive dissonance and Purchase Involvement in the Consumer Buying Context. *The IUP Journal of Marketing Management*, 8(3).
- Ghayoomi, Z., and Nazari, M. (2014). Effective factors on price acceptance in buying social magazine in Iran. *The Business Management Review*, 4(4).
- Grewal, D., Monroe, K.B., and Krishnan, R. (1998). The effect of price comparison advertising on buyers' perceptions of acquisition value, transaction value and behavioral intention, *Journal of Marketing*, 6(2), 46.
- Ha, J.& Jang, S.(2010). Perceived values, satisfaction, and behavioral intentions: the role of familiarity in Korean restaurants. *Hospitality Management*, 29, 2-13.
- Hao, L. (2011). The effect of price discount promotions on consumer responses. *A Thesis*.
- Harcar, T., Ali, K., and Kucukemiroglu, O. (2006). Consumer's perceived value and buying behavior : an empirical investigation. *The Business Review*, 5(2), 55-62.
- Hardesty, D.M., Carlson, J.P., and Bearden, W. (2002). Brand familiarity and invoice price effect on consumer evaluations: the moderating role of skepticism toward advertising. *Journal of Advertising*, 21(2), 1-15. Abstract retrieved from <http://www.tandfonline.com/doi/abs>
- Hesket, J.L. (2002). Beyond customer loyalty. *Managing Service Quality*, 12(6), 355.
- Ho, C. W. (2012). An exploratory study on relationship between factors that influence consumers' perceptions of retail branding and purchase behavior. *Journal of Business Economics*, 4(2), 143-176.
- Hoch, S. J, and Banerji, S. (1993). When do private labels succeed? *Sloan Management Review*, 4, 57-67.
- Huang, L., and Hsieh, Y. (2011). What drives consumer impulse buying? Evidence from retail in Taiwan, *Journal of International Management*, 6(1).
- Huo, H., Xu, W., and Chen, K. (2013). The influence of customer equity drivers on specific purchasing behavior in retail industry. *Information Technology Journal*, 12: 2236-2240
- Jin, B., and Sternquist, B. (2003). The influence of retail environment on price perceptions: an exploratory study of US and Korean students. *International Marketing Review*, 20(6), 643.
- Khalifa, A.S. (2004). Customer value: A review of recent literature and an integrative configuration. *Management Decision*, 42(5-6), 645-666.
- Kharaim, H. S. (2011). The influence of brand loyalty on cosmetics buying behavior of UAE female customers, *International Journal Marketing*, 3(2).
- Kirmani, A., and Baumgartner, H. (2000). Reference points used in quality and value judgments. *Marketing Letters*, 11 (4), 299-310.
- Kos, M., and Vida, I. (2004). An examination of consumer home buying behavior, University of Ljubljana, Slovenia.
- Kotler, P., and Armstrong, G. (2007). *Marketing: An Introduction*. 8th ed. New Jersey: Pearson Prentice Hall.
- Lapierre, J. (2000). Customer perceived value in industrial contexts. *The Journal of Business & Industrial Marketing*, 15(2-3): 122-40.
- Manuka, J. (2008). Customers purchase intention as a reflection of price perception. *Journal of Product and Brand Management*, 17(3), 188-198.
- Martins, M., and Monroe, K.B. (1994). Perceived price fairness: A new look at an old construct. *Advances in Consumer Research*, 21, 75-78.
- Michaelidou, N., and Dibb, S. (2008). Consumer involvement: A new perspective. *Marketing Review*, 8(1), 83-99.
- Mieres, C.G.; Martín, A.M.D. and Gutierrez, J.A.T.(2006). Antecedents of the difference in perceived risk between store brands and national brands. *European Journal of Marketing*, 40, 61-82.



- Moon, S., Russell, G.J., and Duvvuri, S. D. (2006). Profiling the reference price consumer. *Journal of Retailing*, 1, 1-11.
- Nazari, M., Hosseini, M.A.S., and Kalejahi, S.V.T. (2014). Impact of price fairness on price satisfaction, customer satisfaction, and customer loyalty in Iran telecommunication market. *Asian Journal of Research in Marketing*, 3 (1), 131 – 141.
- Nazia, Y. (2011). Impact of brand awareness, perceived quality and customer loyalty on brand profitability and purchase intention: a reseller's view. *Interdisciplinary Journal of Contemporary Research in Business*, 3, 8, 833- 839.
- Nugroho, W. A., and Wihandoyo, L. S.(2009). Consumer's perceived value and buying behavior. *Journal of Business Strategy and Execution*, 2(2), 216-238
- Parasuraman, A. & Grewal, D. (2000). The Impact of technology on the quality-value-loyalty chain: a research agenda. *Journal of the Academy of Marketing Science*, 28(1), 168- 174.
- Payne, A. and Holt, S. (2001). Diagnosing customer value: Integrating the value process and relationship marketing. *British Journal of Management*, 12, 159-182.
- Peng, L., and Liang, S. (2011). The effect of consumer perceived value on purchase intention in e-commerce platform: A time limited promotion perspective. *Journal of Retailing*, 77(2), 203–20
- Permarupan, P.Y., Mohan, M., Al-Mamun, A., and Zainol, N. R. B. (2014). Consumer perceived value and buying behavior of store brands. *International Business Management*, 8 (2), 136-141.
- Petrick, J.F., (2002). Development of a multi-dimensional scale for measuring the perceived value of a service. *Journal of Leisure Research*, 34 (2), 119-134
- Pragya, K., and Nalendra, K, (2011). Purchase decision involvement: A study of edible oils. *Prestige International Journal of Management and Research*, 3 (4), 58-6
- Praveen, S. (2011). Consumer behaviour. Retrieved from University of Calcut, School of Distance Education website: [http://www.academia.edu//CONSUMER\\_BEHAVIOUR\\_BBA\\_Specialization\\_-Marketing\\_BBA\\_Specialization\\_Marketing\\_BBA\\_Specialization\\_-Marketing](http://www.academia.edu//CONSUMER_BEHAVIOUR_BBA_Specialization_-Marketing_BBA_Specialization_Marketing_BBA_Specialization_-Marketing)
- Rajput, A.A., Kalhor, S.H., and Wasif, R. (2012). Impact of product price and quality on consumer buying behavior: Evidence from Pakistan, 4(4). Retrieved from: <http://www.proquest.com>
- Rundle-Thiele, S. and Bennett, R. (2001), A brand for all seasons? A discussion of brand loyalty approaches and their applicability for different markets. *Journal of Product & Brand Management*, 10(1), 25-37.
- Rzem, H., and Debabi, M. (2012). Store image as a moderator of store brand buying behavior. *Journal of Business Studies Quarterly*, 4(1), 130-148.
- Sahney, S., Ghosh, K., and Shrivastava, A. (2013). "Buyer's motivation" for online buying: an empirical case of railway e-ticketing in Indian context. *Journal of Asia Business Studies* 8.1 43-64.
- Sanchez, J., Callarisa, L., Rodriguez, R.M.&Moliner, M.A.(2006). Perceived value of the purchase of a tourism product. *Tourism Management* , 27(3), 394-409.
- Schifman, Leons G. And Kanuk, L.L. (2007). *Consumer Behavior*, 7th Edition, Prentice Hall Inc, Upper Saddle River, New Jersey
- Sheth, J.N., Newman, B.I. and Gross, B.L. (1991). Why we buy what we buy: a theory of consumption value. *Journal of Business Research*, 22(2), 159–70.
- Shukla, P. (2009). Impact of contextual factors, brand loyalty and brand switching on Purchase Decision. *Journal of Consumer Marketing*, 26(5), 348-357.
- Stranahan, H., and Konsiel, D. (2007). E-tail Spending Patterns and The Importance of Online Store Familiarity. *Internet Research*, 17, 421-434. Doi 10.1108/10662240710828076
- Sweeney, J.C., and Soutar, G. N. (2001). Consumer Perceived Value: The Development of a Multiple Item Scale. *Journal of Retailing*, 77(2), 20-203.
- Tam, J.L.M. (2008). Brand familiarity: its effect on satisfaction evaluations. *Journal of Service Marketing*, 22(1), 3-12.
- Vaidyaanathan, R ., and Aggrawal, P. (2000). Strategic brand alliances: implication of infegredient branding for national and private label brand. *Journal Product Brand Management*, 9, 214-228.
- Vantamy, S. (2007). Understanding perceived product quality: Review and recommendations. *Journal of Management*, 3(2).
- Weckmen, N. (2009). Consumer buying behavior case study: Algol technics. A Thesis. Laurea University of Applied Science.
- Wieringa, J.E. and Verhoef .(2007). Understanding customer switching behavior in a liberalizing service market: An exploratory study. *Journal of Service Research*, 10 (2), 174-186.
- Wu, C. C. (2011). The impact of hospital brand image on service quality, patient satisfaction and loyalty. *African Journal of Business Management*, 5(12), 4873-4882.

- Yakup, D., Muchait, C., and Reyhan, O. (2011). The impact of cultural factors on the consumer buying behavior examined through an empirical study. *International Journal of Business and Social Science*, 2(5).
- Yang, D., and Wang, X. (2010). The effects of 2-tier store brands' perceived quality, perceived value, brand knowledge, and attitude on store loyalty. *Front. Bus. Res. China* 2010, 4(1), 1–28.
- Zaichkowsky, J.L. (1985) Measuring the involvement construct. *Journal of Consumer Research*, 12(3), 341-352.
- Zeb, H., Rashid, K., and Javeed, M.B. (2011). Influence of brand on female consumers' buying behavior in Pakistan. *International Journal of Trade Economics and Finance*, 2(3).
- Zeithaml, V.A. (1988). Consumer perceptions of price, quality, and value: A measure model and Synthesis of Evidence, *Journal of Marketing*, 52(3), 2- 22.

# **The Determinant Factors of Market Orientation Over Financial Performance: Mediating Role of Market Performance**

<sup>1</sup> Mukhlis Yunus, <sup>2</sup> Yuliandi Djalil

<sup>1</sup> Lecturer in Program of Magister Management, Economy Faculty-Syiah Kuala University-Banda Aceh, Phone: 085277233889, mukhlis.feusk@gmail.com

<sup>2</sup> Doctoral Program of Management Science, Economy Faculty-Syiah Kuala University-Banda Aceh, Phone: 085361171515, Yuliandidjalil@yahoo.com

## **Abstract**

The paper introduces a new perspective of the interactions that take place between marketing, organizational behavior concepts which affect market and financial performance. This study analyzes the effects exerted by internal marketing, and employees organizational commitment as antecedents of market orientation over financial performance with regard to mediating role of market performance in Aceh private universities. This study raises some hypotheses to acknowledge the problems using quantitative method of 200 respondents, then analyzed using Structural Equation Modeling (SEM) operated by Lisrel. The results of the data analysis showed that internal marketing, organizational commitment and market orientation have positive direct and indirect effects on universities' both market performance (customer satisfaction and customer loyalty) and financial performance. Aceh private universities should convert internal marketing as a strategy into their core operations and systems to meet employees' demands and the universities goals. This conversion shall make employees show their sincere organizational commitment that is beneficial for the universities' market orientation which has a significant impact on market and financial performance.

**Keywords:** Commitment, Internal Marketing, Market Orientation and Performance

## **1 Introduction**

Many higher educations established everywhere so many higher education that fall up in adventures, especially those experienced by private universities. However, very rapid progress in terms of quantity is not matched by an increase in quality so private universities are unhealthy conditions. On the other hand, there is a phenomenon that occurs in the world of higher education in Indonesia, namely a decrease in the amount of public interest in sending their children to private universities. The decrease is due to the low level of public confidence in the universities in Indonesia. The high cost of education if it is associated with a per capita income of the people and the absence of collateral received in the world of work into the public motivating factor for not sending their children to higher education.

For that private universities should improve the quality of its performance in various ways, such as by creating an effective organizational performance, efficient and productive, good marketing, as well as good organizational commitment will create satisfactory academic services students and creates a high quality performance for the college concerned.

According to Richard et al. (2009) organizational performance encompasses three specific areas of firm outcomes: (a) financial performance (profits, return on assets, return on investment, etc.); (b) product market performance (sales, market share, etc.); and (c) shareholder return (total shareholder return, economic value added, etc.). Meanwhile, Homburg and Pflesser (2000) separate market performance from financial performance; while the former includes customer satisfaction and loyalty, the latter can be measured in ROA. Using their dichotomy, argue that market orientation as strategic marketing should influence market performance, which in turn impacts financial performance.

This paper argues that market orientation, both as a culture and a behavior, can not be manifested without organizational commitment not only by top management, but also by all employees within the organization. Caruana and Calleya (1998) have underlined that lack of commitment from employees can be harmful to an organization, resulting in poorer performance arising from inferior service offerings and higher costs. Hence, lack of employees' commitment might negatively affect an organization's market orientation. Accordingly, for Indonesian universities to succeed in their market-oriented endeavors, employees' commitment must be guaranteed. One way of achieving such commitment is the application of internal marketing programs (Cauana and Calleya, 1998; Farzad et

al., 2008). Market orientation and performance are correlated, but it is more important to know how they are related.

There are some researches that found a relationship between internal marketing and organizational commitment, as Caruana and Calleya (1998) assured that. Souchon and Lings (2001) have also suggested that internal marketing practices have been proposed as a key means of increasing staff motivation, organizational commitment and employee satisfaction. Furthermore, Voola et al., (2003) found that there is a positive relation between internal marketing and market orientation, and internal marketing has been considered as an antecedent of market orientation. Kyriazopoulos et al., (2007) also examined the adoption of the internal marketing concept from bank branches' employees and found that internal marketing has a positive effect on market orientation. Zepf (2008) suggested that internal marketing must precede external marketing; it makes no sense to promise excellent service before the company's staff is ready to provide it.

Beside that, Jones et al. (2003) believe that a firm's market orientation as, perceived by salesperson, would increase the salesperson's organizational commitment. Waris (2005), who examined market orientation and organizational commitment in general, found that there is a positive relationship between the two variables. Lings (2004) also suggested that internal aspects of organizational performance (employee satisfaction, employee retention and employee commitment) have a direct effect on external market orientation.

## **2 Literature Review**

### **2.1 Organizational performance**

The empirical literature reports a high diversity of performance indicators (cf., reviews by Combs, Crook, & Shook, 2005; Venkataraman & Ramanujam, 1986); a common distinction is between financial and non-financial measures. Organizational performance comprises the actual output or results of an organization as measured against its intended outputs (or goals and objectives). Measuring the performance of any organizations is a difficult task. According to Richard et al. (2009) organizational performance encompasses three specific areas of firm outcomes: (a) financial performance (profits, return on assets, return on investment, etc.); (b) product market performance (sales, market share, etc.); and (c) shareholder return (total shareholder return, economic value added, etc.). The term Organizational effectiveness is broader.

Meanwhile, Homburg and Pflesser (2000) separate performance into market performance and financial performance; while the former includes customer satisfaction and loyalty, the latter can be measured in ROA. Using their dichotomy, argue that market orientation as strategic marketing should influence market performance, which in turn impacts financial performance. Organizational Performance can be seen as a multi-dimensional construct consisting of more than simply financial performance (Baker and Sinkula, 2005). Organizational performance is described as the extent to which the organization is able to meet the needs of its stakeholders and its own needs for survival (Griffin, 2003).

Further, one of the most recent definitions was provided by Antony and Bhattacharyya (2010) who defined the organizational performance as the measure of organizational success with regards to the value it creates and deliver to internal as well as external customers. Traditionally, the organizational performance has been measured using the cost and account-based measures (Demirbag, Tatoglu, Tekinus, & Zaim, 2006). Due to the differences of the organizational performance definitions, there has been a continuous debate regarding which is the best measure of the organizational performance (Jusoh, Ibrahim, & Zainuddin, 2008).

### **2.2 Market Orientation**

There are several variations of market orientation definitions. Kohli and Jaworski (1990, p.6) defined market orientation as "the organization wide generation of market intelligence pertaining to current and future customer needs, dissemination of the intelligence across departments, and organizations wide responsiveness to it" (known as MARKOR scale) . Narver and Slater (1990, p.2) defined market orientation as "the organization culture that most effectively and efficiently creates the necessary behaviors for the creation of superior value for buyers and, thus, continuous superior performance for the business" (known as MKTOR scale). They include three elements in their market orientation measure: customer orientation, competitor orientation, and inter functional coordination.

Hult et al. (2005) concluded their research by underlining the importance of recognizing the importance of both Narver and Slater's and Kohli and Jaworski's conceptualizations. While the previous detects internal marketing and latter organizational information process behaviors, they together create more holistic image of market orientation than neither alone.

Hult et al. (2005) disagree the idea that market orientation directly leads to enhanced performance. Thus, in their research study these authors hypothesized that market orientation and market information processing (MIP) both are positively related to organizational responsiveness, which in the end has positive effect on performance.

Market orientation is concept rooted in marketing theory (Kok & et al, 2003). Although there are differences in the definition of market orientation, this concept usually focuses on three components: customers, competitors, coordination between tasks. All the definitions offered from market orientation by experts such as Kohli and Jaworski has an operational focus on data collection, data dissemination and the ability to respond to what has been received (Erdil, 2003).

Further, Grinstein (2008, p177) cited definition market orientation (MO) by Narver and Slater (1990) that defines Mo as: "internal marketing that most effectively and efficiently creates the necessary behaviors for the creation of superior value for buyers and thus, continues superior performance for the business"

At first sight there might appear to be an overlap between the market orientation and internal marketing constructs. However, in this study, market orientation is not treated as a type of culture but as a set of behaviors that exists in varying degrees within different organizational types (McClure, 2010). Analyzing the consequences of adopting a market orientation approach has been a hot topic in the marketing and strategy literatures (Pulendran et al. 2000). Yet relatively little research has considered how such adoption influences employee responses (organizational commitment and organizational commitment). In non-profit service settings, which feature direct organization customer interactions, understanding the effects of implementing market-oriented behaviors is an even greater necessity (Kirca et al., 2005).

Schlosser and Naughton (2009) see market orientation linked with resource-based view of the firm (RBV), which defines the resource arrangements and value creation within firm. Market oriented behaviors relate closely to information resources of the firm (*ibid.*). Olavarrieta and Friedman (2008) based on two schools of thought, namely resource-based school of thought and the evolutionary approach to strategy, combined with marketing literature while proposing an integrative model of firm superior performance. Model of these authors simultaneously considered the role of culture and knowledge-related resources, thus linking market orientation literature with dynamic capabilities literature. Thus, market orientation concept has well-grounded position in the strategic marketing discourse.

### 2.3 Internal Marketing

The objective of internal marketing is to get motivated and customer conscious employees in order to achieve service excellence. The use of marketing in the IM context suggests an emphasis on the application of marketing techniques, approaches, concepts, and theories aimed at achieving customer satisfaction in the context of internal customers, in order to achieve success in the external market (Gro'nroos, 1985). Drake et al. (2005) suggest that the effective implementation of marketing techniques internally can create significant bottom-line results.

The IM perspective holds that, by treating both employees and customers with the same total dedication to satisfy their needs, the organization can inspire employees to do extra work beyond the call of duty and help to build and sustain a great organization. IM can perhaps be defined as a mechanism for instilling a "people" orientation within an organization as a prerequisite for instilling and strengthening the service, customer, and marketing orientation among organizational personnel. Ahmed and Rafiq (2004) criticized the notion of "employee as customer" since it raises the question of whether the needs of external customers have primacy over those of employees.

Internal marketing aims to improve customer consciousness by changing the beliefs of the front line employees (Ahmed, Rafiq and Saad, 2003). Helman and Payne (1992) believe the objectives of marketing depend on the reason it is being implemented. Internal marketing may be concerned with improving employee routines through internal motivation. Internal marketing may be concerned with ensuring the entire organization understands each department's function within the organization. The internal marketing function may be aimed at marketing the organizations product or services to customers. Internal marketing aims to improve the overall business process within an organization to ensure that resources to progress the organizations aspiration are made available to the internal customer (Joesph, 1996).

## 2.4 Organizational commitments

Organizational commitment has been variously and extensively defined, measure and researched, but it continues to draw criticism for lack of precision and concept redundancy (Roja and Roast, 2007). Organizational commitment refers to the extent to which an employee develops an attachment and feels a sense of allegiance to his or her employer (The Pennsylvania State University, 2011) Organizational commitment involves more than just company loyalty; its the employee intrinsically wanting to defend against criticism both internal and external (Business Daily Review, 2008). From an individual perspective, organizational commitment has been linked to intrinsic motivation and job satisfaction. Likewise, from an organizational perspective, organizational commitment has positively contributed to organizational attachment (Joo & Lim, 2009).

Three-component model of organizational commitment has been the dominant frame work for organizational commitment researches in the past decade because it is based on a more comprehensive three-component model consist of:

- Affective commitment – refers to employee state of emotional attachment to the organization and is especially sensitive to work experiences such as organizational support (Griffin and Hepburn, 2005; Erdheim et al., 2006). This emotional response has also been described as a linking of individual identity with the identity of organization and as an attachment to the organization for its' own sake, apart from its purely instrumental worth; it results in a situation where the employee wants to continue his or her association with the organization (Dawley et al., 2005).
- Normative commitment – refers to an employees' belief that he or she ought to stay with the organization and develop, because of socialization experiences that emphasize the appropriateness of remaining loyal to one's employer (Griffin and Hepburn, 2005).
- Continuance commitment – might consist of two sub-construct- one based on the degree of personal sacrifice associated with leaving the organization ( Dawley et al., 2005), and the other based on individuals' recognition of the availability of alternatives if they were to leave the organization, often referred to as sunk costs (Namasivayam and Zhao, 2007).

Therefore in the aggregate, companies should strive to hire and retain employees with high organizational commitment because it can "increase performance, reduce absenteeism, [and] reduce turnover", thus providing positive outcomes for both the individual and the organization (Cohen & Golan, 2007, p. 421).

Based on background and literature review above, the proposed conceptual model is depicted in Figure 1.

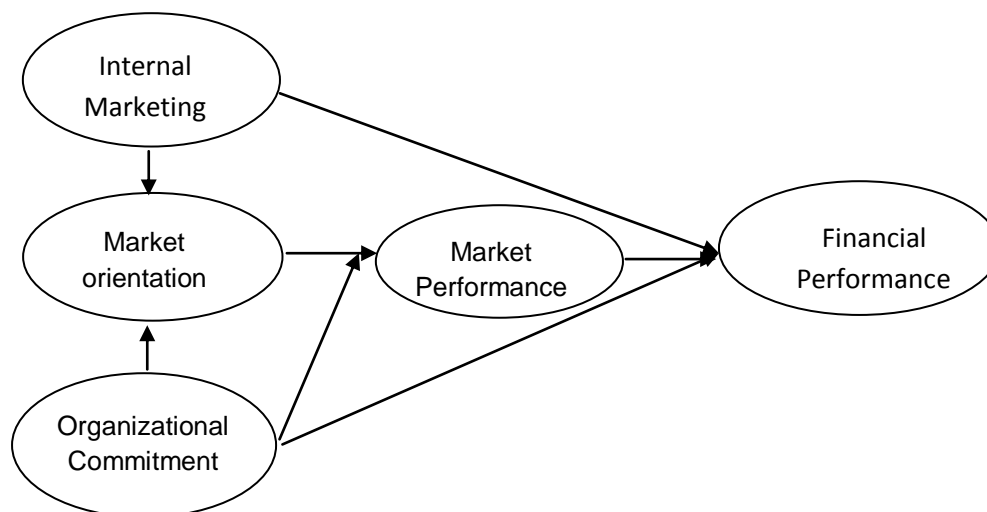


Figure 1. Research Model

Based on explanations above, so research hypothesis as follow:

- H1 : Organizational commitment influence to market orientation positively and significantly
- H2 : Internal marketing influence to market orientation positively and significantly
- H3 : Organizational commitment influence to market performance positively and significantly
- H4 : Internal marketing influence to financial performance positively and significantly
- H5 : Market performance influence to financial performance positively and significantly

### **3. Methodology**

#### **3.1 Research Design**

Research design essentially refers to the strategy or plan of shaping the research (Henn, Weinstein and Foard, 2006), that include the entire process of research from conceptualizing a problem to writing the research question, data collection, analysis, interpretation and report writing (Creswell, 2007). The descriptive research will be doing in this research. Descriptive research did not fit neatly with definitions of quantitative or qualitative research methodology, but it can utilize both elements often within same study

#### **3.2 Research Subject (population & Sample)**

The study focused on private universities in region of Indonesia. The data gathering involved a cross-sectional survey which was conducted with a national sample of private universities in Aceh. An introductory letter and a questionnaire were sent to the respondents of a population of 200 respondents in private universities of Indonesia. In the first mailing, a cover letter, a questionnaire and a pre-paid reply envelope was sent to the person in charge of the organization, since these individuals are most likely to be involved in strategic decisions. The researchers offered to provide a summary of research findings as an incentive. A self-completion questionnaire was developed, addressing the following issues: identification, organizational environment, market orientation, internal marketing, commitment and performance..

The goals of the pre-test were to assess clarity of questions, determine the length of time required for completion, and examine the appropriateness of the subject matter for the population of interest. Based on this feedback the questionnaire was modified, and some items were eliminated, others changed and some added.

#### **3.3. Data Collection.**

The data used in this study was primary data. Primary data is the data obtained from respondents directly, collected through the survey by using specific data collection technique (Sekaran, 2006). The primary data in this study was the data obtained direct in Aceh region as research respondents, and was collected through questionnaires. Data was collected through a survey method. The survey was conducted on 200 respondents. Closed questioners measured using a Likert scale (five opinions about social phenomena. The process of data collection by questionnaire was conducted with enumerators.

#### **3.4. Data Analysis.**

Inferential statistical analysis was aimed to test the research hypothesis. The researchers wanted to test the path analysis used a SEM analysis (Structural Equation Modeling). SEM is a combination of analytical tools of confirmatory factor analysis (factor analysis) Goodness of Fit. The tool for analyzing structural models in this study was the General Structured Component Analysis software / GSCA (Hwang and Takane, 2004.). According to Ghozali (2008), the approach used was Component-Based or Based Variance.

### **4. Result and Discussion**

#### **4.1 Result**

From result of data processing show that internal marketing has a positive effect on market orientation. This hypothesis is verified (with path coefficient =0.370;  $t = 20.21$ ). It shows that the higher the positive the positive internal marketing philosophy adopted within the private universities, the higher would be their market orientation. Internal marketing has a positive direct effect on financial performance, this hypothesis is verified (with the path coefficient =0.511;  $t = 48.491$ ). It shows that the higher the positive internal marketing adopted within private universities, the higher the financial performance will be. Organizational commitment has a positive effect on market orientation, this hypothesis is verified (with the path coefficient =0.259;  $t = 3.429$ ). It shows that the higher the commitment of employees, the higher would be the private universities' market orientation. Further, organizational commitment has a positive effect on market performance, this hypothesis is verified (with the path coefficient =0.101;  $t = 7.300$ ). It shows that the higher the commitment of employees, the higher would be the financial performance of the private universities. Market orientation has a positive effect on market performance of the private universities (customer satisfaction and customer loyalty), this hypothesis is verified (with the path coefficient =0.807;  $t = 11.142$ ). It shows that the higher the positive market orientation adopted within private universities, the higher the market performance will be.

#### **4.2. Discussion**

Some researchers (Lings, 2000; Bouronta et al., 2005) support the hypothesis that internal marketing has a positive effect on market orientation. This study found that internal market has indirect effects on market orientation through organizational commitment, too. Also, Voola et al. (2003) mentioned that a number of variables could likely moderate the internal marketing-market orientation relationship. These may include: the affective commitment of the employees and organizational learning capability. So, internal marketing appears to be means of developing and maintaining a market oriented culture in a private universities.

It was found that internal marketing has a positive direct effect on organizational commitment. This finding is similar to what other previous studies have found (Caruana and Calleya, 1998; Tsai and Wu, 2006; Kyriazopoulos et al., 2007; Hung and Lin, 2008; and Farzad et al., 2008). When the private universitiess provide effective training, a fair reward system, a positive interaction between employees within the private universities and sharing vision among them, this creates more emotionally attached employees with their private universities who want to remain employed. Therefore, if the commercial private universitiess want to ultimately provide a better service experience for their customers, it is recommended that more attention be directed toward enhancing organizational commitment among personnel, with a focus on the effective criteria of internal marketing (Ahmed et al., 2003). Tsai and Wu (2006) suggested, through the design and implementation of human resource management systems for internal marketing, that internal marketing is available to enhance employees' job satisfaction, motivate employees to achieve organizational goals and promote employee perceptions regarding organizational commitment.

As it mentioned before, market orientation causes to develop profitability in each organization and internal marketing as an antecedent of market orientation will affect profitability and in return financial Both of these characteristics as components of market performance will be developed with market orientation, because an organization is market oriented, its' customers and their needs are as important as anything.

Existing literature seems to disagree on what role organizational commitment plays in the market orientation of a firm. Some researchers suggested that market orientation is an antecedent to organizational commitment, such as (Caruana et al., 1997; Jones et al., 2003; Waris, 2005). However, Sivaramakrishnan et al. (2008) suggested that market orientation is a consequence of organizational Sivaramakrishnan et al. (2008) suggest that committed employees are likely to be more willing and more able to implement and/or adopt a market orientation culture than less committed employees. This study argues that organizational commitment is an important antecedent to market orientation, rather than a consequence, as proposed by Kohli and Jaworski (1990). The previous studies supported Kohli and Jaworski's (1990) proposal, but Sivaramakrishnan et al. (2008) used Narver and Slater scale to measure market orientation and found that organizational commitment is antecedent to market orientation.

Although, Sivaramakrishnan et al. (2008) have not found an explanation to the perspectives conflict on the nature of the relation between organizational commitment and market orientation, they said that this relation seems to be a "chicken-and-egg" problem. As Sivaramakrishnan et al. (2008) say, organizational commitment is an employee-based input to create a firm's market orientation culture.



Caruana et al. (1997) examined the relationship between market orientation and organizational commitment through using the three components of organizational commitment (affective commitment, normative commitment, and continuance commitment) and the three dimensions for market orientation (information generation, information gathering and responsiveness). He found that there is a direct link between market orientation and organizational commitment and more specifically between the responsiveness dimension of market orientation and the affective component of organizational commitment. Jones et al. (2003) believe that a firm's market orientation, as perceived by the salesperson, would increase the salesperson's organizational commitment. Moreover, Waris (2005), who examined market orientation and organizational commitment in general, found that there is a positive relationship between the two variables. Lings (2004) also suggested that internal aspects of organizational performance (employee satisfaction, employee retention and employee commitment) have a direct effect on external market orientation. From Narver and Slater (1990) viewpoint market orientation has 3 dimensions (customer orientation, competitor orientation and inter functional coordination), so organizational commitment has significant effects on customer oriented culture. High committed employers would cause to satisfy and eventually loyal customers, means organizational commitment will have important effects on market performance.

## 5. Conclusions and Suggestions

The purpose of this study was to investigate the relationships between internal marketing, market orientation, organizational commitment market and financial performance in private universities. Data were collected using validated scale instruments drawn from relevant literature. The results of the data analysis showed that internal marketing, organizational commitment and market orientation have positive direct and indirect effects on universities' both market performance (customer satisfaction and customer loyalty) and financial performance. Aceh private universities should convert internal marketing as a strategy into their core operations and systems to meet employees' demands and the universities goals. This conversion shall make employees show their sincere organizational commitment that is beneficial for the universities' market orientation which has a significant impact on market and financial performance. This study was based on a single service industry (Private universities sector) with its own peculiar characteristics. It is not clear to what extent the substantive results of this study can be generalized to other industries.

Future research should apply the study's model on a larger population of other types of universities and other service and manufacturing industries. We measured market orientation using MARKOR scale; future researchers can measure this factor with MKTOR scale and attend to behavioral insight of market Organizational citizenship behavior as a variable which has a significant impact on organizational commitment can take place in future researches.

## References

- Ahmed, P. R. (2003). Internal marketing and the mediating role of organizational competencies. *European Journal of Marketing*, 37, 1221-43.
- Anderson, W. E. (1993, spring). The antecedents and consequences of customer satisfaction for firms. *Marketing Sci*, 12, 125–143.
- Antony, J. P, & Bhattacharyya, S.(2010). Measuring organizational performance and organizational excellence of SMEs – Part 2: an empirical study on SMEs in India. *Measuring Business Excellence*, 14(3), 42-52.
- Baker, W. E., & Sinkula, J. M. (2005). Market orientation and the new product paradox. *Journal of Product Innovation Management*, 22(6), 483-502.
- Behn, B. K. (1999). Using Nonfinancial Information to Predict Financial Performance: The Case of the U.S. Airline Industry. *Journal of Accounting, Auditing & Finance*, 14, 29-56.
- Bentler, P. M. (1992). On the fit of models to covariances and methodology to the Bulletin. *Psychological*
- Bolton, R. (1998winter). A dynamic model of the duration of the customer's relationship with a continuous service provider: the role of satisfaction. *Marketing Science*, 17, 45-65.
- Boulding, W. A. (1993, Feb). A dynamic process model of service quality: From expectations to behavioral intentions. *Marketing Research*, 30, 7–27.
- Bouranta, N. M. (2005). The impact of internal marketing to market orientation concept and their effects to private universities performance. *Operational Research: An International Journal*, 5(2), 349-62.

- Capon, N. (1990). Determinants of Financial Performance: A Meta-Analysis. *Management Science*, 36,
- Capon, N. F. (1996). *Toward and integrative explanation of corporate financial performance*.
- Caruana, A. P. (1998). The effect of internal marketing on organizational commitment among retail private universities managers. *International Journal of Private universities Marketing*, 16(3), 108-16.
- Caruana, B. R. (1997). Market orientation and organizational commitment in the Australian public sector. *International Journal of Public Sector Management* , 294-303.
- Combs, J. G., Crook, T. R., & Shook, C. L. (2005). The dimensionality of organizational performance and its implications for strategic management research. In D. J. Ketchen & D. D. Bergh (Eds.), *Research methodology in strategic management*. (pp. 259-286). San Diego, CA: Elsevier.
- Dawley, R. S. (2005). Dimensionality of organizational commitment in volunteer workers: Chamber of Commerce board members and role fulfillment. *Journal of Vocational Behavior*, 67, 511-25.
- Demirbag M. T., Tatoglu, E., Tekinus, M., & Zaim, S. (2006). An analysis of the relationship between TQM implementation and organizational performance: evidence from Turkish SMEs. *Journal of Manufacturing Technology Management*, 17(6), 829-847.
- Deshpande, J. F. (1993, January). Internal marketing, customer orientation, and innovativeness in Japanese firms: a quadrad analyses. *Journal of Marketing*, 57, 23-37.
- Drake, S.M.(2005). *Light Their Fire: Using Internal Marketing to Ignite Employee Performance and*
- E.J ones, P. B. (2003). Firm market orientation and salesperson customer orientation: interpersonal and intrapersonal influences on customer service and retention in business-to-business buyer-seller relationships. *Journal of Business Research*, 56.
- Erdheim, J. (2006). Linking the big five personality constructs to organizational commitment. *Personality and Individual Differences*, 41, 959-70.
- Farzad, A. N. (2008). The effect of internal marketing on organizational commitment in Iranian private universities. *American Journal of Applied Sciences*, 5(11), 1480-6.
- Ghozali, Imam. (2008). *Generalized Structured Component Analysis (GSCA)*. Badan Penerimaan UNDIP, Semarang.
- Griffin, M. 2003. Organizational performance model. Available at: <http://griffin-oc.com/GOC>.
- Griffin, M.L. (2005). Side-bets and reciprocity as determinants of organizational commitment among correctional officers. *Journal of Criminal Justice*, 33, 611-25.
- Gronholdt, L. A. (2000). The Relationship Between Customer Satisfaction and Loyalty: Cross-Industry Differences. *Total Quality Management*, 11(4), S509-S14.
- Gruca, T.S. (2005, July). Customer satisfaction, cash flow, and shareholder value. *Journal of Marketing*,
- Homburg, a. C. (2000, November). A multiple-layer model of market-oriented internal marketing: measurement issues and performance outcomes. *Journal of Marketing Research*, 37, 449-62.
- Hung, J. (2008). The investigation on the internal marketing practices of the international tourism hotel chains. *Journal of International Management Studies*, 170-6.
- Hwang, H and Takane, Y. (2004). Generalized structured Component Analysis. *Psicometric*, vol 69. p.81-99.
- Jusoh, D., Ibrahim, N., & Zainuddin, Y.(2008). The performance consequence of multiple performance measures Usage: Evidence from the Malaysian manufacturers. *International Journal of Productivity and Performance Management*, 57(2), 119-136.
- Kohli, A. K. (1993, November). MARKOR: A measure of market orientation. *Journal of Marketing Research*, 30, 467– 477.
- Kohli, A.K. (1990, April). Market orientation: the construct, research propositions, and managerial implications. *Journal of Marketing*, 54, 1-18.
- Kyriazopoulos, P.(2007). *Implementation internal marketing through employees' motivation*, 1-36.
- Lings, I. (2000). The impact of internal market orientation on external market orientation and business performance: an empirical study of the UK retail market. *ANZMAC Visionary Marketing for the 21st Century: Facing the Challenge Stock-Keeping Units: Examining Patterns of Buyer Behavior*,
- Lings, I. (2004). Internal market orientation construct market orientation. *Journal of Business Research*, 57, 405-13.
- Mittal, V. (2001, February). Satisfaction, repurchase intent and repurchase behavior: investigating the moderating effect of customer characteristics. *Journal of Marketing Research*, 38, 131-42.
- Morgan, R. (1994, July). The commitment– trust theory of relationship marketing. *Journal of Marketing*,
- Narver, J.C. (1990). The effect of a market orientation on business profitability. *Journal of Marketing*, 54, 20-35.

- Oliver, R. (1980, September). A cognitive model of the antecedence and consequences of satisfaction decisions. *Journal of Marketing Research*, 17, 46-9.
- Oliver, R. L. (1997). *Satisfaction A Behavioral Perspective on the Consume*.
- Private universities, R. D. (2000). An Empirical Investigation of an Incentive Plan that Includes Nonfinancial Performance Measures. *The Accounting Review*(1), 65-92.
- Rafiq, M. (2000). Advances in the internal marketing concept: definition, synthesis and extension. *Journal of Services Marketing*, 6, 449-62.
- Reichheld, F. (1996). *The Loyalty Effect: The Hidden Force Behind Growth, Profits, and Lasting Value*.
- Reinartz, W. V. (2000). On the profitability of long-life customers in a noncontractual setting: An empirical investigation and implications for marketing. *Marketing*, 64(4), 17-35.
- Roja, N.S. (2007). *Internal branding*. development of brand values and organizational commitment.
- Sekaran, Uma,(2006). *Research Methods for Business : Metode penelitian untuk Bisnis*, Edisi Keempat, Salemba Empat, Jakarta
- Sivaramakrishnan, S. (2008). The relationship between organizational commitment and market orientation. *Journal of Strategic Marketing*, 16(1), 55-73.
- Souchon, A. I. (2001). *Adopting internal marketing practices across national borders: key propositions and implications*. 1-9.
- Tsai, Y. (2006). Internal marketing, organizational commitment and service quality. *IEEE-Xplore*, 1-7.
- TYAGI, P. (1982, May). Perceived organizational climate and the process of salesperson motivation. *Journal of Marketing Research*, 19(2), 240 – 254.
- Venkatraman, N., & Ramanujam, V. (1986). Measurement of business performance in strategy research: A comparison of approaches. *Academy of Management Review*, 11, 801-814.
- Voola, R. (2003). Leadership styles, internal marketing, and market orientation: conceptualizing the relationships. *ANZMAC Conference Proceedings Adelaide*, 1-7.
- Waris,R.G.(2005). *An examination of internal marketing, employee attitudes, and organizational citizenship behaviors: a path analysis approach*.
- Zepf, P. (2008). Sport sponsorship as an internal marketing tool: employees' sponsorship assessments and their effect on job attitudes. *unpublished submitted in partial fulfillment of the requirement for the degree of Doctor of Philosophy, Florida State University*.

## THE ROLES OF STAKEHOLDERS IN CONTROLLING FIELD CONVERSION OF PADDY PRODUCTION CENTER IN OKU REGENCY

<sup>1</sup>Fifian Permata Sari and <sup>2</sup>Munajat

<sup>1</sup> The Lecturer of Agribusiness Study Programe, Agriculture Faculty of Baturaja University  
Adress: Jln. Ratu Penghulu No. 02301 Karang Sari Baturaja  
[Fifianpermatasari@gmail.com](mailto:Fifianpermatasari@gmail.com), Phone number. 081958364048

<sup>2</sup> The Lecturer of Agribusiness Study Programe, Agriculture Faculty of Baturaja University  
Adress: Jln. Ratu Penghulu No. 02301 Karang Sari Baturaja  
[Munajat.ub@gmail.com](mailto:Munajat.ub@gmail.com). Phone.number 087796966234

### Abstract

The purposes of this research were to analyze the roles of stakeholders in controlling field conversion and to identify the factors of the field conversion to rubber plantation (percentage) in paddy production center in OKU regency. The result showed the rate important role of stakeholders to the ones who were not really important: Department of Agriculture, Department of Agriculture Extension, Department of Food Defense, National Land Agency, sub-district head, farmer, headman, public figures. Meanwhile, based on identification factor field conversion to rubber plantation showed that the highest percentage was rubber price, 50 %, rubber controlling cost was 15 %, rubber distribution was 15 %, and based on the climate, the condition of area, government's support was 15 %.

Keywords: The role of stakeholders, field conversion, identification, paddy production

### A. BACKGROUND

Agricultural sector is a strategic sector and plays an important role in the national economy and community survival, especially in providing contribution to *PDB*, a provider of employment and food providers in this country. Awareness of its role gives effects to the citizens in controlling their agricultural activities though the country has become an industrial country. Accordingly, the control of agricultural field is one of the national policy to maintain the primary agricultural industry in the food supply capacity, in relation to preventing socio-economic losses in the long period given the multi-functional nature of agricultural field (Bappenas and PSE-KP, 2006).

From some researches of Agricultural Socio-Economic Research Center can be revealed that one of the phenomena of field conversion the warrant concern is sporadic and individual dimensions for various purposes such as housing and other facilities. The role of filed conversion is difficult to control so it is the most appropriate approach to handle that is to involve the community through initiatives and collective action (Bappenas and PSE-KP, 2006).

Stakeholders can be defined as individuals, publics, or organizations that could potentially be affected by an activity or policy (Race and Millar, 2006). In other word, stakeholders are the people who take action whether directly or indirectly and take the benefit or vise versa from final decision process.

Based on the results of the study (Muhammad Iqbal and Sumaryanto, 2007), public participation strategy pursued through existence of stakeholders understanding (stakeholder analysis). In other words, the controlling agricultural field conversion strategy based on publics` participations by involving all stakeholders actively as the entry point of planning, implementation, monitoring, and assessment (focus analysis) of legislation and regulations through socialization and advocacy approaches.

Various attempts to control paddy fields conversion have been carried out. Various studies are aimed at understanding the process of conversion, the causes, the typology of conversion, as well as estimates of the negative impacts have been done. Several recommendations have been produced and a

number of policies have been formulated. From the review of the literatures that have been around 11 law products, either in the form of government regulation, Presidential Decree, Regulation or Decision of Ministry. However, until now these policies have not reached the target. The effectiveness can be controlled by not realizing the consistency of planning and lack of coordination and synchronization of implementation (*Direktorat Penatagunaan tanah, badan pertahanan nasional, 2004*).

East OKU regency is one of the largest paddy production center in the South Sumatra province, related to field conversion, as irrigated paddy area center in South Sumatra, East OKU regency faced whether field conversion to plantation subsector or field conversion to residence and place of business. It happens because of rubber price a few years ago has increased. On the other side, the development of OKU regency becomes three regencies, the residential and construction development causes the rate of paddy fields conversion.

Based on Pusvita et al., (2013), shows that the ratio of income between paddy farmers with farmers who have converted their field to the rubber plantation occurs significant difference, that rice farmers' income in average Rp. 11,282,071 per hectare a year while the average income of farmers who have been converted to rubber plantations Rp. 56,808,863 per hectare .

In accordance with this information, this study aims at determining the role of stakeholders in controlling field conversion and identifying the reason of farmers who do field conversion to the rubber plantation in the Nusaraya village, Belitang III sub district, East Ogan Komering Ulu regency.

## B. METHOD OF THE STUDY

This study was conducted from March to April 2014 in East Ogan Komering Ulu (OKUT), South Sumatra Province. The Selection of research areas has been taken purposively because the East OKU Regency is an area of paddy main center in South Sumatra Province. The method of study is a case study where paddy farmers who do field conversion to yearly plantation and other uses as a case in this study. While the sampling method used in this study is a stratified random sampling method (Disproportional random sampling) from all samples of 40 samples that consist of 20 farmers who do field conversion, 1 agricultural extension, 1 headman, 1 sub-district head, 5 members of the agricultural department extension, 2 food defense members, 5 members of the national land agency and five public figures. The data used are primary data and secondary data. The method of analyzing the data is descriptive by describing the role of stakeholders in the field and identifying the process of paddy field conversion to rubber plantation in Nusaraya village Belitang III sub district, East Ogan Komering Ulu regency and also supporting of qualitative data in the form of tabulated data.

## C. RESULTS AND DISCUSSION

Problems over field conversion undertake in the society, it is because of the factors that make paddy field conversion to the plantation sector and non-agricultural sector. The factor is the high prices of agricultural commodity than paddy commodity and on the other hand has been fragmented the field so that the scale of existing businesses is not efficient as factor of field conversion is the development of the area because of the development of the region.

### 1. The Role of Stakeholders in Controlling Field Conversion to Rubber Plantation.

Table 1. Identification of *Stakeholders* who have Important role in Controlling Field Conversion

No	Stakeholders	Bw	Rating	Score
1.	Farmer	0,11	3	0,33
2.	Agricultural Department Extension	0,16	4	0,64
3.	Headman	0,08	2	0,16
4.	Sub-district head	0,12	3	0,36
5.	Department of Agriculture	0,19	5	0,95
6.	DKP	0,14	4	0,56
7.	BPN	0,12	3	0,36
8.	Public Figures	0,08	2	0,16

<b>Total</b>	<b>1</b>	<b>26</b>	<b>3,52</b>
--------------	----------	-----------	-------------

From table 1 showed that the highest role from stakeholders is to control paddy field conversion to rubber plantation. The sequences of the role of stakeholders who give more to very less important are as follows:

One stakeholder of department of agriculture, government's attention is very important in controlling field conversion, for the government must commit in implementing existing policies of the existence of productive land can be maintained so that the opportunity of field conversion occurs or even threatened to be sold by farmers can be handled. Therefore, the government's attention to importance of agricultural land protection must be increased and the implementation of existing policies must be carried out strictly, to do that the government should add agricultural extension workers and care of the existing regulation so that existing policies can work well.

Two stakeholders of agricultural extension, the role of training is to give information about policies by the government for farmers' welfare. For example, giving information about new technologies, increasing the production of farmers, developing the mindset of farmers in taking decision to adopt the technology or information related to the use of agricultural field. The government's commitment in implementing policies to force field conversion goes well so that it will help farmers in applying the existing regulation with the help of agricultural extension.

Three stakeholders of Department of Food Defense (DKP), the role of department of food defense in controlling paddy field conversion to rubber plantation that *DKP* has function to serve and protect the stability and keep food production in that area. Therefore, the presence of Presidential Instruction No. 3/1990 about the prohibition of field conversion outside of agricultural, and the Law of the Republic of Indonesia No. 41 of 2009 about the protection of food agricultural sector. Then certainly give effect to structure of government in carrying out this policy in *DKP*. In East Ogan Komering Ulu field conversion has been not awful yet because regency still got initial "food income" but it still has chance to take field conversion which occurred in other areas so that it is necessary to anticipate the occurrence of paddy field conversion in East Ogan Komering Ulu.

Four stakeholders of National Land Agency (*BPN*), in accordance with the Article 10 of Regulation No. 16 Year 2004 about the settlement of the land administration can only be implemented if it has met the terms of use and land-use designation in accordance with the directives in *Rencana Tata Ruang Wilayah (RTRW)*. Based on the decision, the role of area planning development will be critical in the effort to control the conversion of agricultural land, especially paddy is through restrictions on settlement land administration. So that the control field conversion can be overcome with the clarity of land use.

Five stakeholders of sub-district head, the role of a sub-district head in East Ogan Komering Ulu in implementing a ban of conversion of agricultural land in that area as well as in cooperation with stakeholders such as local government officials East Ogan Komering Ulu accordance with reugulation No. 41 of 2009 about the Protection of Agricultural Land Sustainable, *Perlindungan Lahan Pertanian Pangan Berkelanjutan (PLP2B)* is set up such issues including field conversion that has been mentioned, for those who want to converse field technically irrigated function one hectare must replace with new land area of three hectares. Whereas if field with rainy system will be converted must replace two hectare. While field has been unproductive transformed to enable one hectare must be replaced with one hectare as well. The area of field conversion in East Ogan Komering Ulu has been not the biggets one, but if allowed to continue will increase the extent possible. With the existence of these regulations could help prevent field conversion in East Ogan Komering Ulu.

Six stakeholders of farmers, where the role of a farmer in controlling the conversion of paddy fields conversion to rubber plantation, farmers' field owners will be able to maintain or even wetland function will enable transfer my rubber plant to his farm. This has become one of the reasons for control over field conversion to rubber plantation, often argued that farming paddy farmers can not improve the lives of farmers and are more likely to result from plantation which has a very large result. Therefore dissemination to farmers should be continued and enhanced to improve the welfare of the farmers that the government may intensify counseling to change and help farmers maintain agricultural land, especially paddy.

Seven stakeholders of headman, village leaders or can be called as headman has an important role in controlling paddy field conversion in the village, in this case the role of the headman is to give information that includes how to keep food land, especially for paddy field that has not converted to

other functions for farmers. As a leader in the village, the headman find barriers related to farmers' perspectives, attitudes and decisions which are hard to be ignored. Therefore, to solve these barriers, it needs good communication to the farmers in expressing their opinions and suggestions for farmers, as well as accompanied by agricultural extension workers. In addition, by having local governments' subsidy or governments' help in implementing of existing policies is very helpful.

Eight stakeholders of public figures, the interview result with one of the public figures of farmers who sold the field in the Nusaraya village, Belitang III sub district on 5 April 2012 said that: "I sell the land because my children have become civil servants and they do not want to be farmers. Due to farming income is lower than their income now, and my children think that the farmer is not respectable job". From interviews with public figures in that area, it can be concluded that one of the factors that can be threaten the agricultural field conversion is the people's perspective to the agricultural sector is regarded as unrespectable job. Therefore, people prefer to sell their land in order to have the capital to trade or even the being build the residential land, Based on the condition field conversion will be more difficult to control if the agricultural sector is no longer considered to be promising welfare of the productive field will be converted by farmers. Therefore, it is very important for institutions to establish or create a policy in helping farmers to change their perspectives.

## 2. Identify the Farmers' Reasons in doing the Field Conversion to Rubber Plantation

Identify the Farmers' Reasons in doing the Field Conversion to Rubber Plantation in the Nusaraya Village, Belitang III sub district, East Ogan Komering Ulu by looking at the following factors, namely, the high rubber prices, lower controlling rubber costs, easy rubber distribution, based to the climate, the conditions of area, and government's support.

Research data in form of tabulated data that come from the respondents: 20 samples of farmers who have given their opinions about the paddy field conversion in the Nusaraya village Belitang III sub district of East Ogan Komering Ulu can be seen in Table 2 below.

Table 2. Respondents Identification of Farmer's Reasons in Converting Field to Rubber Plantation in Nusaraya Village (%)

No.	Factors of Identification	Total of sample farmer respondent	Percentage %
1.	Rubber Price	10	50
2.	Rubber Controlling Cost	3	15
3.	Rubber distribution	3	15
4.	Based on the climate	2	10
5.	Government's support	2	10
<b>Total</b>		<b>20</b>	<b>100</b>

From Table 2, it can be seen that the high rubber price factor of 50 percents is a factor that most farmers selected as an example of factors that influence farmers in taking decision to paddy fields conversion to rubber plantation than other factors, namely, the rubber controlling cost is lower by 15 percents, rubber distribution easily by 15 percent, based on the climate and conditions of the area by 10 percents, and 10 percents of government's support.

Based on tabulated data, researchers also add descriptive factors in identifying of field conversion to rubber plantation that is factor of high rubber prices, lower rubber controlling costs, easy rubber distribution, based on the climate, local conditions, and government's support below:

### 1. Rubber Price

High rubber price is one contributing factor in supporting field conversion to rubber plantation. Extensive field area converted from food sector to plantation sector. In other words, that field had been used for paddy converted to plantations as used in this research is field conversion to rubber plantation. According to villagers in Nusaraya village, by conversing the function of the field to the rubber plantation makes farmers' income being increasing and their life is much more prosperous than just taking paddy.

And farmers who are doing field conversion will get two incomes that are rubber production and rice production.

## **2. Rubber Controlling Costs**

Rubber controlling costs are lower than rice farming is a supporting factor for paddy field conversion to rubber plantation in the Nusaraya village, Belitang III sub district, East Ogan Komerung Ulu. By having low rubber controlling costs makes the farmers doing paddy field conversion to rubber plantation. Meanwhile, comparing with farmers who only do the paddy farming so that paddy controlling costs are higher and income is lower than farmers do rubber farming. Therefore, factor of lower rubber controlling costs is one contributing factor to encourage the farmer's decision to converse field to rubber plantation.

## **3. Rubber Distribution**

Easy rubber distribution is one of the factors to identify field conversion to rubber plantation in Nusaraya village, Belitang III subdistrict, East Ogan Komerung Ulu because in one month can be 2 to 4 times the sales of rubber production, while sales of paddy production done after the completion of harvest in 3 months. Looking at easy rubber distribution with high price that the farmers in the Nusaraya village do paddy field conversion to rubber plantation.

## **4. Based on the Climate and the Conditions of Area**

Paddy field in the Nusaraya village, Belitang III subdistrict, East Ogan Komerung Ulu is one of public goods production because beside giving individual production benefits for the owner and also providing social benefits that it can fulfill many people needed. But to fulfill the need, the rice farming became a major food source can not be welfare the farmers so that Nusaraya villagers more like to do paddy field conversion to rubber plantation. While the views of spatial Nusaraya village that often faced flood so that the rice farming frequently unwanted harvest (*puso*) because of that farmers are more likely to do conversion to rubber plantation. Where, annual crops are usually more likely to be able to withstand flooding due to water absorption rubber plant comes more.

## **5. Governor`s Support**

Government support is one of the factors to identify the process of field conversion to the rubber plantation in the village of Nusaraya village, Belitang III sub district, East Ogan Komerung Ulu. By having governor's support to do paddy field conversion in the Nusaraya village so that the farmers do not hesitate to do the field conversion to rubber plantation . Because of that, Nusaraya villagers are more likely to do field conversion to rubber plantation in order to get more income and make their lives much more prosperous.

## **E. CONCLUSION AND SUGGESSTIONS**

From the results of the stud, the writer draws some conclusions about the roles of stakeholders in controlling field conversion in East Ogan Komerung Ulu are:

1. The role of stakeholders in controlling field conversion to rubber plantation from very high to very low contribution , namely the role of the department of agriculture, agricultural extension, Department of Food Defense (DKP), the National Land Agency (BPN), sub-district head, farmers, headman, public figures. The government's role plays high role in controlling the field conversion to rubber plantation because the government has the authority and power to adopt policies that exist in society, including for the prevention of land conversion. And the role of community leaders are very less to cope with land conversion for the views of public figures assume that jobs are less prosperous farmers and dishonorable.



2. Identification of farmer`s reasons in converting the field to rubber plantation in the Nusaraya village Belitang III sub district of East Ogan Komering Ulu, based on the percentage of the factors that affects the highest to lowest that are rubber prices, lower rubber controlling costs, easy rubber distribution, according to the climate, the conditions of the area, and government` support.

### **Suggestions**

1. The government is expected to have commitment in implementing policies related to the impact of the field conversion to rubber plantation. And seriously in following up and giving fine for farmers who do field conversion to rubber plantation.
2. Farmers should be wise in doing field conversion, not only for personal interest but that should be rethinking about the impact of the paddy fields conversion that makes paddy production will be decrease.

### **REFERENCES**

Bappenas dan PSE-KP. 2006. Penyusunan Strategi Pengendalian Alih Fungsi Lahan Pertanian. Kerjasama Direktorat Pangan dan Pertanian-Kantor Menteri Negara Perencanaan Nasional dengan Pusat Analisis Sosial Ekonomi dan Kebijakan Pertanian. Jakarta.

Direktorat penatagunaan tanah, badan pertahanan nasional. 2004. Inventarisasi dan zona tanah sawah beririgasi di indonesia. Badan pertanahan nasional.Jakarta.

Muhammad Iqbal dan Sumaryanto. 2007. Strategi Pengendalian Alih Fungsi Lahan Pertanian Bertumpu pada Partisipasi Masyarakat. <http://pse.litbang.deptan.go.id/ind/index.php/publikasi/analisis-kebijakan-pertanian/356-joomla-promo20/2328-strategi-pengendalian-alih-fungsi-lahan-pertanian-bertumpu-pada-partisipasi-masyarakat>. diakses tanggal 5 januari 2014.

Pusvita, E. Munajat dan Septianita. 2013. Analisis Keeratan Hubungan Pendapatan Petani Setelah Melakukan Alih Fungsi Lahan Swah Ke Tanaman Karet Di Desa Nusaraya Kecamatan Belitang III Kabupaten OKU Timur. Laporan Penelitian Fakultas Pertanian UNBARA. Baturaja (*Tidak Dipublikasikan*)

Race, D. and J. Millar. 2006. Training Manual : Social and Community Dimensions of ACIAR Projects. Australian Center for International Agricultural Research – Institut for Land, Water, and Society of Charles Sturt University. Australia.

## **The Challenges and Opportunities for Innovation and Commercialization of Research in Global Market Competition**

### **The Perception of Sabang Local Community About Marine Marketing Tourism**

<sup>1)</sup>**Syafruddin Chan**

Lecturer of Doctoral Program In Management Science, Syiah Kuala University, Banda Aceh, Indonesia

Email: [syafruddin.chan@gmail.com](mailto:syafruddin.chan@gmail.com), phone number: 081360797423

<sup>2)</sup>**Kurnia Asni**

Ph.D Student of Management Science, Syiah Kuala University, Banda Aceh, Indonesia

Email: [kurnia.asni@gmail.com](mailto:kurnia.asni@gmail.com), phone number: 081362294461

#### **Abstract**

*This research aims to highlight the role of Sabang local communities about the development of marine tourism in Weh Island through collaborative efforts and by encouraging governmental agencies to attract tourists from around the world. Local community will also act as a tourist in the area, as well as those who come from outside Sabang. Little is known about the depth of knowledge local people have. Managing Marine Tourism marketing must be shared between tWeh island government and the local communities, especially in providing employment for those living near the tourist sites. Finding indicate that Sabang citizens have substantial knowledge about Marine Tourism in Weh Island, which help in the development of this sector.*

**Key words:** *Marketing Marine Tourism, Weh Island, Marketing Management.*

#### **Introduction**

The World Tourism Organization (WTO) has defined tourism as " the activities of persons traveling to and staying in places outside their usual environment for not more than one consecutive year for leisure, business and other purposes" (Rowe et al, 2002).

The length of time spent by a tourist in a host country (and likelihood to repeat visits) depends on several factors, one of them being the concerted efforts of both official agencies and non-official agencies, to sustain beautiful memories in the mind of the tourist, for the tourist site in particular and the country as a whole. This can be achieved through popular festivals and the daily coexistence with tourists of the local population, to make tourists feel that they are welcome (Silva, 2004).

The Sabang citizen must understand that Marine Tourism is one of Weh Island's major economic contributors. It is the key to develop Sabang into one of the most prominent marine tourism destination in Indonesia, on apart with Raja Ampat, Bunaken and Wakatobi in the East of Indonesia. In the west of Indonesia, so far, Sabang is the leading marine tourism destination since it has the most attractive diving spot in the region. Historically and scenically, the Sabang town located in Weh Island, n was known as a tourist destination even since the Dutch Colonial era.

A key reason for creating a tourism industry anywhere is to benefit the local

community, in addition to the benefits of economic growth. However to achieve this goal, it is necessary that tourism is planned, developed, promoted, maintained, and operated properly. All stakeholders should have the opportunity to express their opinions and aspirations and help shape the industry in a better direction. Tourism is an industry that does not succeed if it is driven by the local communities only, because they are typically small business owners, or regular employees. Private sectors together with the government can take on the responsibility of developing tourism to move towards a better Aceh (Aceh Institute, 2010)

## **The Value of Marine Tourism to Weh Island**

Most of Weh island's current tourists are backpackers, who love adventure and ecotourism. Aceh is an attractive backpacker destination which Weh island that offers underwater adventures, Ketambe in West of Aceh which offers trekking and hiking in the forest areas of Mount Leuser and Singkil district that offers surfing and canoing.

Weh island is one of the leading tourist regions of Aceh, according to the National Tourism Development Master Plan (as stipulated in Government Regulation No. 50 of 2011, which is a derivative of Act No. 10 of 2009 on Tourism). It has been designated as Development Zone National Tourism (KPPNs) and as the National Tourism Strategic Area (KSPN).

Determination of Pulau Weh as KPPNs and KSPN regions is commendable, in view of the potential for marine tourism there. Rubiah island marine park with faces Weh Island offers a beauty and diversity of marine life that attracts a lot of tourists. In the Western region of Indonesia, particularly in Sumatra, Pulau Weh is the only major existing diving tourist destination. Due to its underwater natural beauty, uniqueness and its accessibility, it is reasonable for the Indonesian government to establish Weh island as KPPNs and KSPN region. This was also the reason that prompted the authors to focus on maritime tourist attraction in Weh island for this research.

Given Weh Island has become a priority for the central government to be developed further, this is an opportunity and momentum for local government and tourism stakeholders in Weh island to be a stimulant that can improve the site. How can Weh Island development meet the demands of tourists (tourist requirement) there.

Weh Island itself is located at the westernmost tip of the Indonesian archipelago. In terms of location, this island is somewhat less favorable for economic development if we rely solely on the production and trade business only. Therefore tourism is one of the most obvious choices for economic development in Weh island, because it is supported by adequate resources and contains a beautiful marine park that can attract the divers from around the world.

Weh Island is a beautiful island. The island has an exotic landscape, with palm tree beaches, hilly terrain, rain forest, and charming villages with houses that draw from the legacy of the colonial period, and impressive Islamic architecture. Weh island most dazzling and the sought-after by tourists, are located under the sea, known as marine parks Rubiah Island (Rubiah Sea Garden). There are more than 19 (nineteen) diving spots in this marine park region with natural beauty and charm and are visited by many tourists through the sport of scuba diving, ranging from exotic coral (exotic reef), fish, and other marine life.

One excellent diving spot contained in this area is the ruins of Sophie Rickmers ship that sank during World War II first. This spot is now known as WM II Wreck Sophie Rickmers, where there are a lot of fish of different types, which made this shipwreck as their "home".

As mentioned previously, Weh Island has long been a popular tourist destination, especially for marine tourism, with the island marine park Rubiah as its icon. However, the prolonged conflict in Aceh for more than 29 years, saw the popularity of Weh island in the eyes of foreign tourists recede. Coupled with the tsunami in 2004, tourists may be reluctant to come to Aceh.

Tourism is one of the important sectors of the Sabang economy, as the number

of arrivals to the island is growing year by year. The numbers of tourist arrived in 2014 was double that of to the previous years. Sabang Board Authority (BPKS) expected to have 1 million tourist arrival in 2020, consist of **800,000** local and **200,000** foreign tourist. If the average local spends Rp 1 million per capita, and a foreigner spends Rp 2,5 million per capita for a 4 day and 4 night stay, the total revenue accumulated will be **Rp 1,3 trillion**. This is a very significant amount of money to accelerate Sabang into become a city that can drive its communities to have better lives and more prosperity. (BPKS, Sabang 2013)

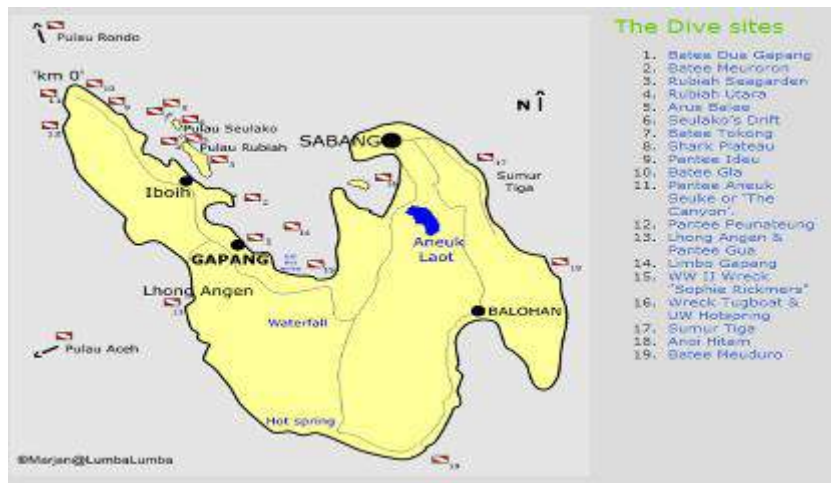


Figure1: Diving Spots in Weh Island

## Tourist Behavior and Tourism Marketing Mix

To answer whether knowledge about tourists' behavior is useful for practicing managers of tourism industries would involve a consideration of various important issues regarding current tourism trends.

In general, tourism can be defined in behavioral terms as persons who travel away from their normal residential region for a temporary period of at least one night. Their behavior involves a search for leisure experiences from interactions with features or characteristics of places they choose to visit (Leiper, 1997).

Referring to the Leiper's statement, understanding tourist consumer behavior is not merely of academic interest but provides knowledge for effective tourism planning and marketing. Although some writers (e.g., Jelincic, 1999; Meethan, 2001;) consider that understanding the behavior of tourism consumers from different countries is less important in the globalization era since tourists tend to have very similar traveling habits, Douglas and Wind (1987) and Kean (2003) insist that the world is not yet globalized; therefore, tourist consumer behavior of each country is still different and needs to be understood according to the fact that there are many determining factors influencing travelers' supply and demand (Horton, 1984; Assael, 1995; Sharpley, 1996). Swarbrooke and Horner (1999, p. 3).

The subject of consumer behavior is key to the underpinning of all marketing activity which is carried out to develop, promote and sell tourism products. Clearly, if we are to optimize the effectiveness and efficiency of marketing activities, we must try to understand how consumers make their decisions to purchase or use tourism products. If we understand their behavior patterns, then we will know when we need to intervene in the process to obtain the results that we want. We will know who to target at a particular time with a particular tourism product. More importantly, we will know to persuade them to choose certain products, which we will have designed more effectively to meet their particular needs and wants. An understanding of consumer

behavior is therefore crucial to make marketing activity more successful.

Local community in Sabang are not the primary tourism target Weh Island, but some of them are will be involved directly in delivering tourism services, it might be useful to know and understand their perception toward the products offered to their potential guests perception. With this knowledge, the decision makers such as the government in charge of developing tourism in Sabang, will have some information to be used as a base for decision making to make the tourist industry in Weh island become more advanced in the future.

In term of cost, McManus (2010) mentioned that the elements of tourism marketing mix have high cost such as branding, which may include brand name, product name, logo, tagline, key messages, and photography. Other elements of marketing collateral (banners, brochures, flyers, signs and posters) and this includes cost such as designing of attractive photography and logos, also printing brochures cost and the cost to distribute these brochures.

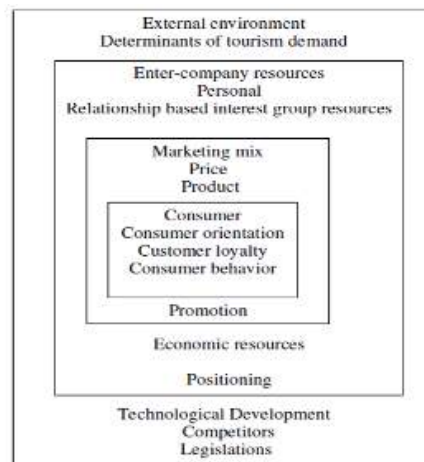
In this regard, some authors have suggested some means that aim to reduce the cost such as :

- Employing inputs from less expensive resources
- Focus on products that do not require substantial additions, leading to cost reduction. especially the labor cost
- Achieving economies of scale by high volume sales
- Get attractive discount on purchases like transportation, hospitality and food (Fyall and Garrod, 2005, p.89)

Internal mix elements include for example, hospitality, guest relations, quality control, personal sales and employee morale. The external mix elements, devoted to attract new customers through offering recreational facilities eg., the comfortable traveling, hotels and pricing ([www.tripod.com/travel and- tourist- marketing .html](http://www.tripod.com/travel-and-tourist-marketing.html)). In their study entitled "Using multiple sense in tourism marketing" Isaccsson and Alakosk, (2009) pointed out that marketing forces used by tourism organizations in order to achieve a targeted level of sales in a targeted market.

They have suggested that the tourism marketing system included the 4Ps, and economic environment, the organization of resources and government legislation, which need to be technologies that can influence consumer behavior.

This technique according to Isacsson and Alakosk, (2009) is, multisensory marketing communication. The figure below shows how this technique has a role among the tourism marketing mix in the area of touching the customer's senses.



**Figure 1: Marketing System for any Organization**

The community's interest in the development of tourism in the country pertains to the recognition of the members of this community that tourism contribute actively to

increase their income (Forstner, 2004). In Saudi Arabia for example, Sahari (2010) indicates that there are three thousand jobs available in the pilgrimage season with rewards of up to five thousand riyals (Alsahari, Ali, 2010). Another example from Europe in ski seasonal jobs, where professional catering experience is essential as well as excellent organizational and people skills. These skills are necessary in preparing menu plans at the chalet, shopping, preparing breakfast, afternoon tea and dinner, in addition to welcoming guests and looking after them during their stay in the chalet ([www.natives.co.UK](http://www.natives.co.UK)).

The marketing mix for travel and tourism is a strategy that includes a package of offers that would achieve the best attraction for tourists. Depending upon who is doing the marketing, the tourism and recreation organizations adopt internal and external programs aimed at achieving different goals. The internal mix elements are offered to customers completely on site, and they are dependent upon the quality of the provided services to the visitors by the communities.

For Weh Island, in a study by Aceh Institute, (2010) The researcher pointed out that the tourism industry in Weh Island has not achieved its full potential and it seems very important for the different stakeholders to develop Sabang tourism through multiple collaborative efforts. In this regard, governmental and non-governmental efforts must interact to achieve that potential for development. Officials should be aware that the role of the community in the development of tourism will be more effective, greater the engagement of its members in the work of tourism. Therefore the focus must be on local young people who have knowledge about the attractive locations in Weh Island, and who have the appropriate level of education, especially in the field of foreign languages.

Perhaps the most graphic evidence of the positive role played by the Sabang community in its field of tourism is joining a number of citizens to participate in the activities performed by Sabang Yatch and Cruise Club to join various game involved tourists that arrive to Sabang using Yatch or Cruise Ships, including performing dance.

In term of protecting nature, Panglima Laot, together with Fauna and Flora International (FFI), an NGO that supports local community to protect coral, forest and decorative fish, has adopted a people-centered approach to protecting nature, where business projects are being developed to create economic and social benefits for local communities (FFI for the conservation of nature, Weh Island, 2008). This makes Panglima Laot together with FFI responsible for socio-economic development including eco-tourism operations.

## Research Type

This research is an exploratory one, it aims to identify to what extent the local people of Sabang know about tourist sites, places of recreation, and the names and locations of sites, the benefits of marine tourism in Weh Island and the necessity to preserve the tourism natural resource both above the land and under the sea.

## Data collection

The researcher addressed five questions to fifty respondents representing the sectors shown in Table 1.

**Table 1: The Data Collection Structure**

Sectors	Males	Females	Total
High school students	5	5	10
Souvenir Sellers	8	2	10
Public employees	6	4	10
The Restaurant	7	3	10
Taxi drivers	10	---	10
Total	36	14	50

**The questions addresses to respondents.**

1. What are the names of **three** favorites place in Sabang where tourist usually come in Weh Island?
2. What are the **three** main tourist attractions available in Sabang for tourists?
3. Can you mention name **three** main diving spots in Weh Island?
4. If a tourist asked you for the most appropriate accommodation to stay in Weh Island, what are the top **three** places to go?
5. What are the **three** most important natural resources to be preserved in Sabang regarding marine tourism attractiveness?

Top three places asked are already known as favorit places visited by tourist based on the amount of tourists visited those places every year.

The following 5 (five) tables show the answers of the respondent to these questions.

**Table 2**

**Respondents answers to the study question No 1 : What are the names of three favorites place in Sabang where tourist usually come in Weh Island?**

Sex	Categories	Q11		Q12		Q13	
		Right	Wrong	Right	Wrong	Right	Wrong
Male	Students	5	0	3	2	3	2
	Souvenirs sellers	8	0	7	1	6	2
	Public employees	6	0	5	1	4	2
	The Restaurant Employee	7	0	7	0	6	1
	Taxi drivers	10	0	<b>9</b>	<b>1</b>	8	2
	<b>Total</b>	<b>36</b>	<b>0</b>	31	5	27	9
Female	Students	5	0	5	0	5	0
	Souvenirs sellers	2	0	2	0	2	0
	Public employees	4	0	2	2	3	1
	The Restaurant Employee	3	0	2	1	3	0
	Taxi drivers	0	0	0	0	0	0
	<b>Total</b>	<b>14</b>	<b>0</b>	<b>11</b>	<b>3</b>	13	1
Total	Students	10	0	8	2	8	2
	Souvenirs sellers	10	0	9	1	8	2
	Public employees	10	0	7	3	7	3
	The Restaurant Employee	10	0	9	1	9	1
	Taxi drivers	10	0	9	1	8	2
	<b>Total</b>	<b>50</b>	<b>0</b>	<b>42</b>	<b>8</b>	40	10
	Percentage (%)	100	0	84	16	80	20

From the table above we can see that the answer for question number one is quite good. Since most of them can identify three favorite place that usually visited by tourism which are : **Iboih, Gapang and Sumur Tiga**. Although some of them have the wrong answer but the percentage was quite low.

**Table 3**  
**Respondents answers to the study question No 2 : What are the three main**  
tourist attractions available in Sabang for tourist?

Sex	Categories	Q21		Q22		Q23	
		Right	Wrong	Right	Wrong	Right	Wrong
<b>Male</b>	Students	5	0	3	2	4	1
	Souvenirs sellers	8	0	6	2	5	3
	Public employees	6	0	4	2	5	1
	The Restaurant Employee	7	0	7	0	3	4
	Taxi drivers	10	0	10	0	5	5
	<b>Total</b>	<b>36</b>	<b>0</b>	<b>30</b>	<b>6</b>	<b>22</b>	<b>14</b>
<b>Female</b>	Students	5	0	3	2	0	5
	Souvenirs sellers	2	0	2	0	2	0
	Public employees	4	0	4	0	0	4
	The Restaurant Employee	3	0	3	0	3	0
	Taxi drivers	0	0	0	0	0	0
	<b>Total</b>	<b>14</b>	<b>0</b>	<b>12</b>	<b>2</b>	<b>5</b>	<b>9</b>
<b>Total</b>	Students	10	0	6	4	4	6
	Souvenirs sellers	10	0	8	2	7	3
	Public employees	10	0	8	2	5	5
	The Restaurant Employee	10	0	10	0	6	4
	Taxi drivers	10	0	10	0	5	5
	<b>Total</b>	<b>50</b>	<b>0</b>	<b>42</b>	<b>8</b>	<b>27</b>	<b>23</b>
	<b>Percentage (%)</b>	100	0	84	16	54	46

From the table above we can see that the answer for question number one is quite good. Since most of them can identify three favorite place that usually visited by tourism which are : **Diving, Snorkeling and Sightseeing**. Although some of them have the wrong answer but the percentage was quite low

**Table 4**  
Respondents answering to the study questions No 3: Can you mention three  
main diving spots in Weh Island?

Sex	Categories	Q31		Q32		Q33	
		Right	Wrong	Right	Wrong	Right	Wrong
<b>Male</b>	Students	5	0	5	0	0	5
	Souvenirs sellers	4	4	5	3	8	0
	Public employees	6	0	2	4	6	0
	Restaurant Employee	1	6	7	0	2	5
	Taxi drivers	5	5	7	3	7	3



	<b>Total</b>	21	15	26	10	23	13
<b>Female</b>	Students	0	5	5	0	4	1
	Souvenirs sellers	2	0	0	2	2	0
	Public employees	0	4	4	0	0	4
	Restaurant Employee	3	0	0	3	3	0
	Taxi drivers	0	0	0	0	0	0
	<b>Total</b>	5	9	9	5	9	5
<b>Total</b>	Students	5	5	10	0	4	6
	Souvenirs sellers	6	4	5	5	10	0
	Public employees	6	4	6	4	6	4
	Restaurant Employee	4	6	7	3	5	5
	Taxi drivers	5	5	7	3	7	3
	<b>Total</b>	26	24	35	15	32	18
	<b>Percentage (%)</b>	52	48	70	30	64	36

From the table above we can see that the answer for question number one is quite good. Since most of them can identify three favorite place that usually visited by tourism which are : **WW II Wreck “Sophie Rickmers”, Rubiah Sea Garden, Batee Dua Gapang**. Although some of them have the wrong answer but the percentage was quite small, and can still be tolerated.

**Table 5**  
**Respondents answering to the study questions Number 4 : If a tourist asked you for the most appropriate accommodation to stay in Weh Island, what is the top three place to go?**

<b>Sex</b>	<b>Categories</b>	<b>Q41</b>		<b>Q42</b>		<b>Q43</b>	
		<b>Right</b>	<b>Wrong</b>	<b>Right</b>	<b>Wrong</b>	<b>Right</b>	<b>Wrong</b>
<b>Male</b>	Students	5	0	5	0	1	4
	Souvenirs sellers	7	1	7	1	5	3
	Public employees	6	0	2	4	6	0
	Restaurant Employee	6	1	7	0	6	1
	Taxi drivers	5	5	10	0	7	3
	<b>Total</b>	29	7	31	5	25	11
<b>Female</b>	Students	5	0	0	5	2	3
	Souvenirs sellers	1	1	0	2	2	0
	Public employees	3	1	0	4	2	2
	Restaurant Employee	3	0	3	0	3	0
	Taxi drivers	0	0	0	0	0	0
	<b>Total</b>	12	2	3	11	9	5
<b>Total</b>	Students	10	0	5	5	3	7
	Souvenirs sellers	8	2	7	3	7	3
	Public employees	9	1	2	8	8	2
	Restaurant	9	1	10	0	9	1

	Employee						
	Taxi drivers	5	5	10	0	7	3
	<b>Total</b>	41	9	34	16	34	16
	<b>Percentage (%)</b>	82	18	68	32	68	32

From the table above we can see that the answer for question number one is quite good. Since all of them can identify three favorite place that usually visited by tourism which are : **Freddy Sumur Tiga, Casa Nemo and Vincent**. Although some of them have the wrong answer but the percentage was quite small, and can still be tolerated.

**Table 6**  
**Respondents answering to the study questions Number 5**

Sex	Categories	X51		X52		X53	
		Right	Wrong	Right	Wrong	Right	Wrong
Male	Students	3	2	5	0	3	2
	Souvenirs sellers	4	4	6	2	3	5
	Public employees	3	3	5	1	2	4
	Restaurant Employee	3	4	6	1	3	4
	Taxi drivers	4	6	5	5	4	6
	<b>Total</b>	17	19	27	9	15	21
Female	Students	3	2	3	2	2	3
	Souvenirs sellers	1	1	1	1	1	1
	Public employees	2	2	2	2	1	3
	Restaurant Employee	3	0	3	0	0	3
	Taxi drivers	0	0	0	0	0	0
	<b>Total</b>	9	5	9	5	4	10
Total	Students	6	4	8	2	5	5
	Souvenirs sellers	5	5	7	3	4	6
	Public employees	5	5	7	3	3	7
	Restaurant Employee	6	4	9	1	3	7
	Taxi drivers	4	6	5	5	4	6
	<b>Total</b>	26	24	36	14	19	31
	<b>Percentage (%)</b>	52	48	72	28	38	62

From the table above we can see that the answer for question number one is quite good. Since all of them can identify three favorite place that usually visited by tourism which are : **Coral, Decorative Fish. Rain Forest**. Although some of them have the wrong answer but the percentage was quite small, and can still be tolerated.

### Conclusion

The results suggested that those who are asked to response to the questionnaires, there are no significant different among respondent categories about marine tourist attribute in

Sabang. The level of knowledge about marine tourism product available in Weh Island were known quite well by Sabang residents. Tourist souvenirs sellers have very good information too on tourism in Weh Island, although the questiones asked were not related to the souvenir shops where they work. As for public employees, their answers were correct, except for the first question and the third question, where most of them indicated right only the names of two out of three sites. The restaurant employee also have perfect knowledge about the marine tourist attraction and the place to stay, but they have weak knowledge about recreation sites. And finally, taxi drivers were the best respondents for most of the questions.

## Recommendations

In order to activate the role of the Sabang communities in the development of tourism in Weh Island, the researcher presents the following recommendations:

- 1- The official agency in charge of tourism development in Sabang including, The Ministry of Tourism in coordination with the Ministry of Education and local government in Sabang, must increase education for school students about tourism in Sabang
- 2- The government agencies including the Sabang Authoruthy (BPKS) must provide adequate support for community-based organizations concerned with the protection of nature, and private sector organizations that provide different tourism services.
- 3- The theory test for bus and taxi drivers must include the names and locations of tourist sites in Weh Island, especially those who will work in the tourist agencies.

## References

- Rowe, A et al. (2002). *Travel and Tourism, Standard Level*, U.K.: Cambridge University Press.
- Silva, Ray De. (2004). Book Review: *Tourism Management (3<sup>rd</sup> Ed)* Author Lei Per, N, *Research and Practice Journal*, Vol112/Issue, 1.
- Abutaieh , Hala. (2010). *Tourism: A comprehensive Renaissance During the reign of his majesty the king to make the sector a major tributary of the state treasury.*
- Weh Island Tourism Board, Website: [www.visitWeh Island.com](http://www.visitWeh Island.com)
- McManas, Simon. (2010). *Tourism Marketing Mix what's the recipe for success*
- Fyall, Alan and Garrod, Brian. (2005). *Tourism marketing: A collaborative Approach*, U.K. (Romwell Press).
- Issaccson, Annica and Alakoski, Lenna. (2009). *Using multiple senses in tourism marketing, international scientific conference " Planning for the future-learning from the past: contemporary development in tourism, travel and hospitality "* Rhodes, Greece, 2009.
- Forstner, Kathrin. (2004). *Community ventures and access to markets: the role of intermediaries in marketing rural tourism products, development policy review*, 2004, 22(5): 497-514.

Al-Sahari, Ali (2010). Three thousand jobs in pilgrimage season.

Al Hasanat, Sami (2010), Sociocultural impacts of tourism on the local communities at Petra, Weh Island, European Journal of Scientific Research, Vol.44, No.3 (2010 ) pp.347-386.

## **The Challenges and Opportunies for Innovation and Commercialization of Research in Global Market Competition**

### **The Influence of Sales Promotion Framing on the Buying Interest Mediated by Transactional Value as the Value Perceived by Consumers**

Nurainun<sup>1</sup>, Syafruddin Chan<sup>2</sup>

<sup>1</sup>PhD Student at Management Science of Syiah Kuala University, Aceh -Indonesia  
Email: [ainunsamka@yahoo.com](mailto:ainunsamka@yahoo.com) phone number: 085228331075

<sup>2</sup>Lecturer at Ph.D Management science Program Syiah Kuala University  
Email: [syafruddin.chan@gmail.com](mailto:syafruddin.chan@gmail.com), phone number: 081360797423

#### **Abstract**

The objective of the study plan in this article is to identify the influence of sales promotion or a promotion price framed in different forms, such as promotion price (discount) that framed in the percentage off (% off) and cents off (IDR off) on the consumer buying interest mediated by transactional value. A laboratory experiment method is employed in this research with 2 (IDR off vs % off) x 2 (high price vs low price) design experiment between subject factorial design for ladies clothing shopping goods. The experiment is conducted to 100 female college students at Economic Faculty of Syiah Kuala University. The hypothesis is examined using ANOVA and PLS WAIDR.

**Key words:** *sales promotion framing; transactional values; consumer buying interest.*

#### **1. Introduction**

Sales promotion is an integrated marketing communication tool that is often used by companies to increase their sales level quickly in a short time. We used to find the forms of sales promotion like price promotion (discount, bonus pack, buy one get one and free gift) in shopping centers. Each of these promotion forms (the framing of promotion) is believed to have different impacts for consumers when they evaluate these promotion types (based on gain and loss) and at the end affect their behavior. Thus, when a company wants to use those forms of promotion then the company has to be able to identify whether those promotions can influence the consumers (Diamond, 1992).

Various impacts of price promotion framing have attract many researchers, among others is a study conducted by Chen *et al.* (1998) who identify the effect of price promotion framing on the consumer perception and purchase intention. The study found that the forms of price promotion like discount in currency value (\$ off) is more significant for higher price products while discount in percentage (% off) is more suitable for lower price products and also has a significant impact on consumer perception and purchase intention. This finding is supported by a study conducted by Gendall *et al.* (2006) who found that the framing in dollar is significantly more effective for higher price products compared to the framing in percentage, conversely the framing of price discount for lower price product only has very small effect or arguably does not has any effect at all.

Moreover, Sinha and Smith (2000) found that the three types of promotion forms, i.e. % off (50% off), extra-product or promotion volume (buy one get one) mixed promotion (buy two get 50% off) is differently affect the consumer perceived value and thus it is moderated by stock-up characteristic. While Gamliel and Herstein (2012) found that the promotion form with negative framing (lose if you don't purchase) is more influential on the consumer buying interest (purchase intention) compared to positive framing (save if you purchase). This is because consumers perceive that the obtained monetary gain is higher in a negative promotion form. Therefore, the consumers are willing to buy the private brand products when the promotion price is informed in a negative framing (loss) rather than in a positive one (Gamliel and Herstein, 2012). The result from another study mentions that the reduce price in the form of free product option is more favorable than the promotion price like rebate (Munger and Grewal, 2001).

In doing marketing activity, like sales promotion, company used to apply various promotion forms at once in order to influence the consumer behaviors. As mentioned earlier, the company has to be able to identify whether those forms of promotion can influence the consumer behavior, especially purchase intention, or not. The consumer perception on an offered value in the promotion form should be positive and thus is able to influence the consumer behavior. If the price reduction is too small then the consumer does not see the differences between reference prices and discounted prices that encourage them to not make any purchase. While when the price reduction is too large then the consumer will be suspicious that there is an inappropriate price is offered. Thus they will not believe that the higher reference price is the actual price or in another word the consumer will distrust to the quality of the product (Monroe, 1979 in Della Bitta *et al.*, 1986).

In order to make a deal offering can be positively perceived, the sellers have to emphasize the value of the offers they made. The one value-based strategy involves an emphasize on value to obtain product or so-called acquisition value (Monroe and Chapman, 1997) and those sellers can increase the perception value by increasing buyer perception to the product quality or relative value for selling price. The sellers can also compare the lower selling price from reference price that promoted to increase the buyer's value perception. This value-oriented strategy is aimed to increase the perception of buyer's value or so-called transaction value. The deal offering that made can influence the buyer's value perception through transaction value. A study conducted by Grewal *et al.* (1998) mentions that the perceived transaction value has a positive relationship with the willingness to buy. The more consumers have a positive perception to the deal offering, the more positive transaction value perceived by consumers or buyers.

Therefore, this research plan attempts to raise an issue on how the sales promotion framing (% off and cents off) impact on the consumer's buying interest by transactional value. Particularly, it is aimed at identifying the influence of the discount promotion form in percentages off (% off) and cents off (IDR off) to the value perceived by consumers or so-called transactional value as well as its impact on the buyer's purchase intention. This research plan consists of introduction, study of literature, research methodology and conclusion.

## **2. Study of Literature**

### **2.1. Sales Promotion and Framing Effect**

Sales promotion is part of an integrated marketing communication that is used to influence the consumer behavior. The sales promotion tools consist of various forms of promotion, such as discount, rebate, premium, sweepstakes, coupon, etc. Those types of promotion are closely associated with framing and prospect theory. This is because in evaluating those types of promotion (goodness/badness), the consumers' behavior is strongly influenced by how those promotions is framed, whether they are framed as gain or loss. It is very difficult to predict when consumers perceive promotion as gain and when they perceive it as reduced loss. When a retailer informs the price after rebate, it will introduce the consumer about integrating rebate with the purchase prices of products. If it is happened, then the rebate will be regarded as reduced losses. The perception about rebate can be similar to the perception about discount. For some people, coupon can reduce losses because it makes total expenditure becomes smaller. However, for other some people, coupon is regarded as gain because it gives saving that can be used to buy other products. Therefore, the framing of particular promotion is idiosyncratically influenced by many factors (Diamond, 1992).

In mental accounting, Thaler mentions that psychologically consumers tend to show mental accounting for their transactional gains or losses that is based on different response for particular outcomes. Moreover, psychologically people will segregate gains and integrate losses. This is because some promotion types describe relative small gains to relative big losses that is called price paid. According to Thaler, in a certain case someone can segregate gains (silver lining) or integrate it with price and then translate it as reduced losses. Whether they perceived it as gain or reduced it as losses is highly depend on the nature of the promotion itself, monetary or non-monetary (Sinha & Smith, 2000).

As described beforehand, there are many things that affect a decision, whether an option is perceived as gains or otherwise as losses. The framing process shows that a different promotion with an equal value can be perceived differently, i.e. as gains and reduced losses. A sales promotion framing framework considers the necessary degree of effort that integrate promotional benefits with pricing information. When a promotion is conducted in a monetary unit like discount,

then the promotion will be integrated with price and will be framed as reduced loss. On the contrary, if the promotion is conducted in a non-monetary unit like free goods, then the benefit of the promotion will be difficult to integrate with price and that such of promotion is often consider as separate gains. The benefit from the perceived gain is segregated from the real reference prices while reduced losses are linked with reference price. This phenomenon describes that the promotion which is regard as reduced losses will have an impact on the reference price from a promotion that is perceived as gains (Campbell & Diamond, 1990).

These forms of promotion have diverse impact on consumers' behavior depend on how they are framed. This issue has attracted many researchers' interest, among others in a study conducted by Gilbert and Jackaria (2002) who state that among four forms of promotion those are used as promotion tools, i.e. coupon, price discount, sample and buy one get one free, only price discount that has an impact on product trial and purchase acceleration; bonus pack influence the brand switching behavior (Seibert, 1997); promotion price (cents off vs % off) influence the consumer's perception and buying interest (Chen *et al.*, 1998); promotion price influence the consumer's perception value and has an implication on the purchase intention; and the price reduction in extra free form is more preferably compared to conventional rebate (Munger & Grewal, 2001).

The monetary promotion form or price off or discount is defined as straight price reduction or price cuts that made in time of purchasing. The price off (discount) can be formed in cents off, for example discount IDR 15.000, or rebate in tensile (% off), like discount 15%.

In the prospect theory initiated by Kahneman and Tversky, it is mentioned that an equal value can be framed in different form. In their result of study that compares between cents off discount and tensile discount (% off), Chen *et al.* (1998) stated that the monetary promotion that framed in dollar is more suitable for higher price product while the tensile form (% off) is more suitable for lower price product. Moreover, this tensile form has an impact on consumers' perception and purchase intention.

The straight price deal is perceived to be able to influence consumer because in evaluating that deal promotion the consumers can directly compare the deal value that offered with the internal reference price owned by consumers themselves. Monroe (1973) and Monroe *et al.* (1991) in Grewal *et al.* (1998) define the internal reference price as price (or scale of price) that existed in buyers' memories and served as their reference in judging or comparing the actual price. The retailer used to employ discount price to increase their store traffic and stimulate the purchase rate.

## **2.2. Value Perceived by Consumers (Transactional Value)**

In this research plan, the transactional value is used to describe the value perceived by consumers to those forms of promotion. Zeithaml (1988) defined the perceived value as the consumer's overall assessment of the utility of a product based on what is received and what is given. How does the value perception of buyers in evaluating that promotional offer? According to the prospect theory developed by Kahneman and Tversky (1979), Thaler (1985) in Yadaf and Monre (1993) proposed that the overall utility from a single item transaction can be conceptualized as a utility that consists of acquisition utility and transaction utility. Thaler argued that the acquisition utility obtained from consumers depends on the value of received product compared to expenditure. While transaction utility is solely depend on perceived service from that deal. On the other hand, the transaction utility measurement depends on the price paid by consumers compared to the reference price (Thaler, 1985).

The same statement is expressed by Grewal *et al.* (1998), who stated that the buyer is exposed in the price comparison advertisement and the same price promotion presented through a same deal or bargain that explicitly reduce the price scale. Moreover, the buyers are likely to judge the merits or the value of the deal by comparing the sales price with their own internal reference price. Therefore, a buyer who judge the financial terms from price offer can perceive the additional value exceed the acquisition one.

In Grewal *et al.*, (1998), the perceived transaction value is defined as perception of psychological satisfaction or pleasure derived from price deal benefit. Hence, the price reduction is considered as gains that compared to the sale price and reference price. Therefore, the reduction of price paid by consumers perceived as gains that defines as transaction value. Thus, the monetary promotion should be able to increase the transaction value if the selling price is below the consumers' internal reference price and if the price reduction is not negatively affected on

consumer's reference price. Della Bitta *et al.*, (1981) asserted that the promotion will more credible if it is included regular and promotion price.

### 2.3. Purchase Intention

The purchase intention or the willingness to buy has been widely used in the literatures as the next buying predictor. The results of previous studies (Dodds *et al.*, 1991; Grewal *et al.*, 1998) found that the buying interest is positively corresponded to the perceived value. Dodds *et al.* (1998) defines the purchase intention or the willingness to buy as the possibility of buyer that intends to buy a product. The value perception is directly influence the willingness to buy. In another study, Dodds *et al.* (1991) found that there is a positive relationship between value that perceived as buying interest and brand effect. While Munger and Grewal (2001) found that the effect of promotional frames on purchase intention is fully mediated by the perception of value.

### 2.4. Research Model

The research model in this research plan can be described as below:

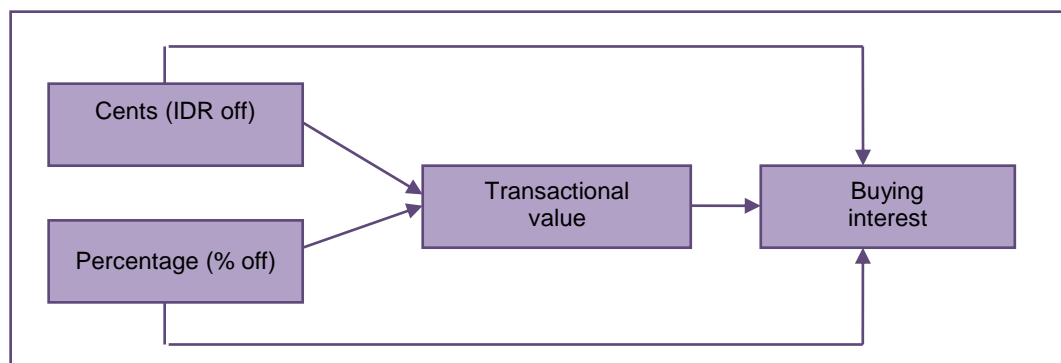


Figure 1. Research model

### 2.5. Hypotheses

There are two hypotheses that can be raised in this research plan, i.e.:

- H1: The percentage off (% off) form has an effect on buying interest mediated by transaction value that perceived by consumers.
- H2: The cents off (IDR off) form has an effect on buying interest mediated by transaction value that perceived by consumers.

## 3. Research Method

### 3.1. Research Design

We use a laboratory experiment to examine the hypotheses in this research plan. The reason for choosing this experiment is because it is cheaper and easier to control external variables that can disrupt the effects of variable that will be studied. The design experiment to be used in this research is a statistical factorial design that is able to measure the effect of two or more independent variable at various levels. In this factorial design, the interactions among variable are allowed, and in this study we use a between subject factorial design.

In this research plan, there are two independent variables that will be manipulated, i.e. the percentages off (% off) and cents off (IDR off) and the subject is ladies clothing shopping goods which often use this types of promotion price to persuade their buyers, respectively for low price brand clothing and high price brand clothing. Thus, the design experiment will form 2 (% off and IDR off) x 2 (low price and high price) between subject factorial design.



Moreover, in this research design, there is a treatment in the form of brochure of each clothing products that provide promotional price of percentages off (% off) and cents off (IDR off) for high price and low price clothing.

### 3.2. Participants

The participants in this study are 100 female students at Economic Faculty of Syiah Kuala University from various departments. The reason for choosing female students is because the brand clothing to be studied is the female clothing brand. Then, the participants will be divided into four groups that placed randomly, each of groups consists 25 participants.

Each group will be treated with brochures to attract their respond to the ongoing sales promotion. Each of participants will be treated differently by providing them with a brochure that figure out the ongoing promotion. The homogeneity among groups is examined through sex and ages as well as class of that are expected to give similar respond to the promotion that offered.

### 3.3. Manipulation Check

The manipulation check is conducted to distinguish and determine the clothing brand that is in the highest level of price and in the lowest level of price.

### 3.4. Instrument and Measurement Scale

The questionnaire that use as an instrument in this research consists of a series of questions that are grouped in a construct. The transaction value construct will use three items of question from Grewal *et al.* (1998) measured with Likert scale, while the buying interest will be measured through two questions from Munger and Grewal (2001) by using seven-point bipolar scale, i.e. (1) would not consider buying/would consider buying, (2) definitely will not buy/definitely will buy. The independent variables or promotional prices are measured using nominal scale.

The measurement of validity and reliability is conducted at transactional value construct and buying interest. The validity measurement is conducted using CFA (confirmatory factor analysis) and the reliability using Cronbach alpha (Cronbach  $\alpha$ ) 0,75.

The analysis tools that will be used to examine the hypotheses are ANOVA and PLS WAIDR. ANOVA (analysis of variance) is used to analyze the difference between two or more number of groups (Hair *et al.*, 2006), while PLS is used to examine the mediation relationship among variables.

## 4. Conclusions

Sales promotion can be described in different forms but with the same purpose. This is in accordance with the core of prospect theory initiated by Kahneman dan Tversky that states that an equal value can be framed in a different way. The framing process shows that the different promotion with the equal value can be perceived differently as gains or reduced losses. An approach that predicts sales promotion framing considers the necessary degree of efforts that integrate promotional benefits with pricing information. When a promotion is conducted in a monetary unit, like discount, then that promotion will be integrated to price, thus this promotion will be framed as reduced loss.

Each of consumers has their own perception on those forms of promotion, whether it is perceived as gains or reduced losses that can influence their behavior to various marketing programs in a company. Therefore, the company has to be able to identify the most suitable promotional form that can affect their decisions.

### Journal Paper Reference

1. Campbell, Leland. & Diamond, W. D. (1990). "Framing and sales promotions: the characteristics of a "good deal". *Journal of Consumer Marketing*, Vol.7, No.4, pp. 25-31.

2. Chen, S.F., Monroe, K.B., and Lou, Y.C. (1998). "The effects of framing price promotion messages on consumers' perceptions and purchase intentions", *Journal of Retailing*, Vol. 74, No.3, pp. 353-372.
3. Dodds, W.B., Monroe, K.B., and Grewal, D. (1991). "The Effects of Price, Brand name, and store information on buyers perceptions of product evaluations", *Journal of Marketing Research*, Vol. 28, No. 3, pp. 307-319.
4. Diamond, W.D. (1992). "Just What is a "Dollar's Worth"? Consumer reaction to price discount vs extra product promotions". *Journal of Retailing*, Vol. 68, No.3, pp. 254-270.
5. Della bitta, A.J., Monroe, K.B., and McGinnis, J.M. (1981). "Consumer perceptions of comparative price advertisements", *Journal of Marketing Research*, Vol. 18, No.4, pp.416-427.
6. Gilbert, D.G., and Jackaria, N. (2002), "The efficacy of sales promotions in UK supermarkets: a consumer view", *International Journal of Retail & Distribution Management*, Vol.30, No.6, pp. 315-322.
7. Grewal, D., Monroe, K.B., and Krishnan, R. (1998). "The effects of price-comparison advertising on buyers' perceptions of acquisition value, transaction value and behavioral intention", *Journal of Marketing*, Vol.62, No.2, pp.46-59.
8. Grewal, D., Krishnan, R., Baker, Julie., and Borin, Norm. (1998). "The effects of store name, brand name and price discount on consumers' evaluations and purchase intention", *Journal of Retailing*, Vol. 74, No.3, pp.331-325.
9. Gamliel, Eyal., and Herstein, Ram., (2012). "Effects of message framing and involvement on price deal effectiveness", *Journal of Marketing*, Vol. 46, No. 9, pp. 1215-1232.
10. Gamliel, Eyal., and Herstein, Ram. (2007), "The effect of framing on willingness to buy private brand", *Journal of Consumer Marketing*, Vol. 24, No. 6, pp. 334-339.
11. Gendal, Philip., Hoek, Janet., Pope, Tracy., and Young, Karen. (2006), "Message framing effects on price discounting", *Journal of Product & Brand Management*, Vol. 15, No.7, pp.458-465.
12. Hair, J. Joseph., Black, C. William., Babin, J. Barry., Anderson, E. Rolph., and Tatham, L. Ronald. (2006). *Multivariate Data Analysis*. 6th ed. New Jersey, Pearson Education International.
13. Munger, L.J., and Grewal, D.(2001), "The effects of alternative price promotional methods on consumers' product evaluations and purchase intentions", *Journal of Product & Brand Management*, Vol.10, No, 3, pp. 185-197.
14. Monroe, K.B. (1973). "Buyers' subjective perceptions of price", *Journal of Marketing Research*, Vol. 10, No, 1, pp. 254-270.
15. Sinha, Indrajit., and Smith, M.F. (2000), "Consumers perceptions of promotional framing of price", *Psychology & Marketing*, Vol. 17, No. 3, pp. 257- 275.
16. Seibert, L.J. (1997), "What consumer think about bonus pack sales promotion", *Marketing News*, Vol. 31, No. 4, pg. 9.
17. Thaler, H.R. (1983), "Mental accounting and consumer choice", *Marketing Science*, Vol. 4, No. 3, pp. 139-2214.
18. Yadav, M.S., and Monroe, K.B. (1993), "How buyers perceive saving in a bundle price: an examination of a bundle's transaction value" , *Journal of Marketing Research*, Vol. 30, No.3, pp. 350-358.

### Book Reference

1. Crask, Melvin., Fox, Richard. J and Stout, Roy G. (1995) *Marketing Research: Principles and Applications*. 3<sup>th</sup> ed. New Jersey. Prentice Hall Englewoods Cliffs.

## Human Capital and Entrepreneur

Yanita

Student at Doctoral graduate program in  
Management Science, Syiah Kuala University  
Darussalam Banda Aceh, Aceh

[Yanita61@yahoo.com](mailto:Yanita61@yahoo.com)

085238057305

### Abstract

Human capital is a strong predictor of a person's tendency to establish new businesses. The quality of the entrepreneur brings to the new venture is highly dependent on the resources developed through education and experience. There is a strong relationship between entrepreneurship and human capital. Knowledge is an important asset for small and medium enterprises within the global competition

Keyword: Human Capital and Entrepreneur

### 1. Introduction

Human Capital (HC) and Support Organization (OS) for intrapreneurial activity has become an important field of research but separate management for the last three decades. Environment that supports the organization, as a factor in the internal climate of the hand is described as a facilitator for the organization to spur entrepreneurial activity organizations (eg Miller and Friesen, 1982; Schuler, 1986;. Kuratko et al, 1990, 2005; Zahra and Covin, 1995; Antoncic and Hisrich, 2001; Hornsby et al, 2002 .; Dess et al., 2003). On the other hand, the HC as a core competence is described as one of the main indicators of organizational learning (eg Bantel and Jackson, 1989; Edvinssondan Malone, 1997; Hitt et al, 2001 .; Skaggs and Youndt, 2004). Therefore it is worth to investigate their combined effect on the innovative performance while the second has the ability to independently contribute to the ability of the organization of different aspects.

Human capital is a strong predictor of a person's tendency to establish new businesses. Entrepreneurial human capital accumulation is the result of long-term arising from the process of achievement and cognitive abilities from childhood (education, subject knowledge, intelligence), the advantages of childhood associated with the resources of the family of origin (parent education, employment), involvement parents, interests and family structure combined with the cumulative "events" and "opportunity" and offered experienced during adulthood (work experience, academic qualifications) Entrepreneurship is not limited to the creation of new businesses (Cooper and Dunkelberg 1986), is also not a single event-action (Birley and Westhead 1993). Individuals can become the owner of the business by acquiring or inherit an existing business. In addition,

employers may not limit yourself to one company, instead choosing to run some of them. This broader perspective emphasizes the heterogeneity of entrepreneurship and highlights the importance of studying both companies and individual entrepreneurs.

The need to better understand the behavior of individual entrepreneurs in a variety of settings beyond the one-time entrepreneurial experience highlighted by, among others, MacMillan (1986), Westhead and Wright (1998), Carter and Ram (2003), Westhead et al. (2005) and Stam et al. (2008). businessmen involved in more than one business, or entrepreneur habits, which gets the attention of researchers. Knowledge is an important asset for small and medium enterprises within the global competition. Even if many employers do not pay enough attention to the importance of knowledge, this source can be determined important factors of success of small and medium enterprises and undoubtedly one of the sources of sustainable competitive advantage. Organizations become more knowledge intensive and they employ "mind" more than "hand" .Penelitian related to the study of the importance of knowledge, these days often performed in an entrepreneurial environment. In the process of dealing with the knowledge the company had to face a variety of conditions and their organizational culture requires strong support from top management.

Knowledge is an important asset for small and medium enterprises within the global competition. Even if many employers do not pay enough attention to the importance of knowledge, this source can be determined important factors of success of small and medium enterprises and undoubtedly one of the sources of sustainable competitive advantage. Organizations become more knowledge intensive and they employ "mind" more than "hand" .Penelitian related to the study of the importance of knowledge, these days often performed in an entrepreneurial environment. In the process of dealing with the knowledge the company had to face a variety of conditions and their organizational culture requires strong support from top management.

In-depth research on various dimensions of knowledge entrepreneurs in the enterprise and analysis of the influence of individual dimensions on the company's business success is hard to find. Their role in the economy continues to be important to improve the performance of the economy, especially given the recent declines seen in economic growth (Ruzzier and Konecnik, 2006) The Company's success often depends on knowledge entrepreneurs (Hambrick and Mason, 1984), which mainly depends on the education and past experience (Barker and Mueller, 2002; Hadjimanolis, 2000). Veblen (1904) emphasized the importance of knowledge in the company. Drucker (1959) defines knowledge as

an important resource for the company. Nonaka and Takeuchi (1995), in their theory of the knowledge-based organization, further emphasizing the importance of knowledge. Their thesis is that knowledge is a source of sustainable competitive advantage, and knowledge is basic foundation for economic performance. Research has shown that knowledge has become an important tool to strengthen a company's competitive advantage (Hsu et al., 2007). Brüderl et al. (1992) agree that the level of higher education employers have a positive effect on productivity, which then leads to higher profitability of human capital is knowledge and skills acquired through formal and informal learning are in individual (Becker, 1964) and is associated with the inter-generational transmission of knowledge and learning behaviors (Roberts, 2001).

According to the literature, whereas human capital is a resource that is beneficial for all the work that has more to do with the effects of multiple careers. Williams, (2004) explains that individuals with a higher stock of human capital and skills are better able to utilize their resources in entrepreneurship than salary job. Many researchers argue that the quality of the entrepreneur brings to the new venture is highly dependent on the resources developed through education and experience (Jones et al., 2010; Mosey and Wright, 2007; Rae and Carswell, 2001; Shrader and Siegel, 2007; Serneels, 2008; Wright et al, 2007). However, human capital measures are not very consistent conventional in explaining variation entrepreneurial potential (Rees and Shah, 1986).

## **2 . Literature Review**

### **2.1 Human Capital and Entrepreneurship**

#### **2.1.1 Introduction of human capital**

According to Nahapiet (2011) Human capital is a term used by 'neoclassical economists' to describe the stock of knowledge and skills that allow individuals to create economic value. Foundation for our understanding of human capital founded by economists such as Adam Smith, JS Mill and Alfred Marshall. In particular, the recognition that people and machines, building and land 'productive resources. (1776) identification of Adam Smith on the division of labor as a key element in improving 'dexterity of workers is central to the development of efficient production systems (see the 1993 edition).

Human capital to fame in the 1960s with the work of Schultz (1961) and Becker (1964) although the explicit use of the term is associated with Pigou (1928). Schultz (1961) argues that the post-war economic recovery is the result of a healthy and educated population. Human capital is accumulated as individuals

invest in their education, health and experience. Daniel Bell (1973) work on the nature of the 'post-industrial

### **2.1.2 Human Capital and Entrepreneurship**

The quality of the entrepreneur brings to the new venture is highly dependent on the resources developed through education and experience (Gibb, 1996). Teece (2011) agree that there is a strong relationship between entrepreneurship and human capital. He refers to the concept of Schumpeterian 'creative destruction' to identify the key role of individuals educated in economic restructuring: 'Whether one focuses on value creation or capture it, in the last few decades that numerati and writers (expert talent) and employers have become more important creation and management of technology in the global economy '(Teece, 2011: 531) emphasizes the importance of knowledge workers .

Human capital individuals can form their prospects (Becker, 1975, 1993). The link between employers, human resource profile and the results related to corporate entry / exit and performance have been identified (Jovanovic, 1982).

First, a broader conceptualization of human capital an entrepreneur? Previous research has focused primarily on education, work experience, industry-specific experience and selfemployment experience (Bates, 1990; Bru derl et al, 1992 .; Gimeno et al, 1997 .; Bosma et al., 2004). The increasing interest in the economic aspects of psychology (Tversky and Kahneman, 1974; Witt, 1998) show an entrepreneur Cognitive characteristics also need to be considered (Alvarez and Busenitz, 2001; Ferrante, 2005; Markman et al., 2002).

Human capital with respect to the perceived ability (ie self-efficacy) were, therefore, considered as an additional indicator of human capital is widely used. conscious entrepreneurs can invest in human capital. We also recognize that human capital might be accumulated (eg work experience and entrepreneurial experience) without any investment decisions are made.

Second, a distinction is made between public employers (ie, education and work experience) and entrepreneurship-specific human capital profile (ie, managerial ability, entrepreneurial capabilities, technical capabilities and business ownership experience). while the distinction between general and specific human capital is not new, we strive to provide insight into the relative importance of both general and specific human capital in respect of premises.

Third, the two results of the entrepreneurial process is considered. Previous research has generally focused on a single outcome. That the profile of human

resources leveraged to identify possible business opportunities are not the same as that required to pursue business opportunities. The elements of entrepreneur human resource intensity associated with the identification of opportunities (ie number of opportunities identified) were identified as well as pursue opportunities related to the intensity (ie the number of opportunities identified pursued). Pursue opportunities defined as the commitment of time and resources into opportunities to create or buy a business. Because, employers may decide to pursue only a subset of them identifying opportunities, making this selection implies that the opportunity be pursued are considered higher quality besarn context identification and pursuit of opportunities.

Fourth, we investigated whether entrepreneurs are looking for more information and take advantage of certain types of information, identify and pursue more business opportunities. This evidence would provide additional insight into the debate about whether the opportunities identified as a result of the search of information, or the alertness of entrepreneurs (Kaish and Gilad, 1991; fiet, 1996, 2002; Kirzner, 1997; fiet et al., 2005)

## **2.2. General human capital**

### **2.2.1. Education**

Education is one of the most frequently examined components of human capital. Formal education is seen as necessary in the cognitive skills to adapt to the changing environment (Hatch and Dyer, 2004). Education is a source of knowledge, skill, discipline, motivation and confidence (Cooper et al., 1994). Educated entrepreneurs may be better able to cope with complex problems. They can also take advantage of the knowledge and social contacts generated through the education system to acquire the resources to identify and exploit business opportunities (Shane, 2003; Arenius and Declercq, 2005).

### **2.2.2. Work Experience**

Work experience is seen as a key indicator of general human capital (Castanias and Helfat, 2001). This can assist in the integration and accumulation of new knowledge. Furthermore, it can enable individuals to adapt to new situations (Davidsson and Honig, 2003) and become more productive (Parker, 2006). work experience related to the ability to be entrepreneur and start a new company (Bates, 1990; Gimeno et al, 1997). some indicators of work experience has been operationalized, which makes comparisons between studies difficult. Work experience has often operationalized in terms of several years of work

experience (Evans and Leighton, 1989; derl Bru et al., 1992). The last indicator provide limited information about the nature of the skills and knowledge acquired. Two alternative indicators have been considered work experience (Gimeno et al., 1997). First, the number of previous jobs held fulltime measure the extent of a different experience. Individuals with more than one job setting exposure may acquire diverse range of knowledge and skills. However, it may be subject to diminishing returns (Mincer, 1974). Often the work setting exposure may signal poor individuals with knowledge and skills. Secondly, highlighting the achievement level of quality (or trait) of work experience gained. individuals who have held managerial positions (or previously self-employed) may be endowed with a superior level of general human capital (Bates, 1990), which can be used to identify and pursue business opportunities.

### **2.3. Specific human capital Entrepreneurship**

#### **2.3.1. Business ownership experience**

Business ownership has long been recognized as an important dimension of entrepreneurship (Hawley, 1907). Fama and Jensen (1983) argues that entrepreneurial firms are those that combine classical residual risk bearers and decision makers in the same individual.

#### **2.3.2. Ability**

To ensure a competitive edge, companies may need to acquire, create and integrate resources into dynamic capabilities (Teece et al., 1997). Some people have the ability to acquire, combine and coordinate essential resources for entrepreneurial activity (Erikson, 2002). An individual can be explored with respect to the ability of self-assessed because they represent the core of an individual's self-efficacy beliefs (Delmar, 2000) Previous studies provide mixed evidence on human capital and the possibility of becoming entrepreneurs. Some authors argue that more educated individuals endowed with better skills and abilities, and thus may have a higher probability of choosing entrepreneurship less educated (Lucas 1978; Carrasco 1999). In addition, better educated individuals tend to be better informed, implying that they are more efficient in assessing new entrepreneurial opportunities (Rees and Shah 1986). In contrast, various authors found negative or nonlinear effects on human capital and entrepreneurship (Blanchflower 2004; Minniti and Bygrave 2003; Koellinger et al., 2007). Some studies show-for cases where human resources are typically measured through tertiary education that individuals with higher levels of education have less opportunity to become entrepreneurs than men holding the



primary and secondary education (Amaral and Baptista 2007; Livanos 2009). One common explanation is that a higher level of general human resources to facilitate the transition to wage labor, thus reducing the possibility of entrepreneurship (Evans and Leighton 1989; De Wit and Van Winden 1989). This view is reinforced by Lazear (2005), who argued that employers should be endowed with human capital varies from formal education (for example, to understand other forms of knowledge and experience and apply more specifically to entrepreneurship), while those who paid the employee must specialists (ie, with an educational background that is more specific).

Definitions of variables for each determinant in the conceptual model of the knowledge owner / manager through four dimensions:

- (1) level of education;
- (2) Experience of working;
- (3) knowledge of functional disciplines; and
- (4) self-confidence

## **2.4 Entrepreneurship**

Information on human resources became one of the most important elements of enterprise information base in their struggle to gain a competitive edge in the market. The spirit of entrepreneurship includes four main points: innovation, risk, possibility for significant wealth creation, and the relative speed of wealth creation (Engineered Lifestyles, 2012). While some researchers argue that starting any small business is entrepreneurial ventures, we would argue that entrepreneurs are people encouraged to take risks in the near future with the hope of financial reward signifikan. Studi signifikan has been done at various levels of entrepreneurship around the world. Nadim Ahmad and Anders Hoffman (2007) developed a Framework for Addressing and Measuring Entrepreneurship that surpasses the simple view that employers are only small to medium business owner or self-employed. The authors develop a framework that can be used to measure the indicators of entrepreneurship across national boundaries that are specifically intended to help governments measure and encourage entrepreneurs.

According to Ahmad and Hoffman, entrepreneurship is defined by the "creation of value through the identification and exploitation of new products, processes, and markets and is not unique preserve of small companies or entrepreneurs, important though it is for the entrepreneurial process" (p. 5). The authors cite the project "Micro-policies for Growth and Productivity" OECD (2007) identify three

important areas of policy to encourage entrepreneurship: entrepreneurial education, access to venture capital and bankruptcy regimes. These three policy areas are also mentioned in most reports of national entrepreneurship (p. 19).

Entrepreneurs are individuals, acting independently or as part of organization, which makes a new business or develop innovation and taking risks insert them into the market. Employers can individuals ion independently or in a surface organization at any level. Thus, top-level managers, middle and first-level managers, staff personnel literature on how to build internal environment suitable for intrapreneurship seems to be based on some organizational or managerial tool settings; namely:

- (1) management support to generate and develop new business ideas.
- (2) Allocation of time to spare.
- (3) the appropriate organizational structure of, in particular, decentralization level or the autonomy of decision-making.
- (4) the proper use of incentives and rewards.
- (5) Tolerance for trial-and-error or failure in the case of a creative venture or project implementation risk (eg Kuratko et al, 1990, 1992, 2004, 2005 .; Hornsby et al., 1999, 2002)., And they result in service good or company can all be entrepreneurs.

In the economic theory of human capital is assumed to be one of the main drivers of entrepreneurial success, increasing the capacity of the owner to perform generic tasks entrepreneurship and to discover and exploit business opportunities (Becker 1964; Shane and Venkataraman2000). Not only the human resources help owners to plan for future goals and obtain other resources such as financial and physical capital (Brush et al., 2001), but also facilitates the acquisition of new skills and knowledge (Barney 1995; Cohen and Levinthal 1990). Human capital has been argued to play a greater role in knowledge-intensive activity involving rapid changes and new requirements in the workplace (Honig et al 2001;. Pennings 1998; Bosma et al., 2004; Sonnentag and Frese 2002).

#### **REFRESENSI :**

1. Deniz Ucbasaran Paul Westhead Mike Wright *Opportunity Identification and Pursuit: Does an Entrepreneur's Human Capital Matter?*
2. Miguel Amaral Æ Rui Baptista Æ Francisco Five *Serial entrepreneurship: impact of human capital on time to re-entry*

3. Koper Slovenia , Lynn L. K. Lim • Christopher C. A. Chan • Peter Dallimore *Perceptions of Human Capital Measures: From Corporate Executives and Investors*
4. Doris Gomezelj Omerzel and Bos`tjan Antonc`ic` *Critical entrepreneur knowledge dimensions for the SME performance*
5. Evidence Łukasz Sienkiewicz Warsaw School of Economics, Poland *Human Capital Measurement Practices in Polish Companies – Empirical*  
[lukasz.sienkiewicz@sgh.waw.p](mailto:lukasz.sienkiewicz@sgh.waw.p)
6. Dr. Ahmad Ahmadian, Professor and Eric Curtiss, Colorado State University-Pueblo, Pueblo, CO *Global Entrepreneurialism: A Comparative Analysis of Entrepreneurial Spirit and Drive around the World*
7. Forough Tabatabaei\*, Masoud Jafari  
.Department of Agricultural Extension and Education, Islamic Azad University, Birjand Branch, *IranThe study of the effect of information sources on the entrepreneurial spirit of rural women (A case study:Zabol, Iran)*
8. Domingo Ribeiro Soriano and Jose´ Manuel Comeche Marti´nezUniversity of Valencia, Valencia, Spain *Transmitting the entrepreneurial spirit to the work team in SMEs:importance of leadership*
9. Ph.D. Branislav Djordjevic, Emeritus *Strategic Entrepreneurship*
10. Lutfihak Alpkandepartment of Management, Gebze Institute of Technology, Kocaeli, TurkeyCagri BulutFaculty of Economics and Administrative Sciences, Yasar University,Izmir, TurkeyGurhan GundayTurkish Institute for Industrial Management (TUBITAK TUSSIDE),Kocaeli, Turkey, andGunduz Ulusoy and Kemal KilicFaculty of Engineering and Natural Sciences, Sabanci University,Istanbul, *Turkey Organizational support forintrapreneurship and itsinteraction with human capital to enhance innovative performance*
11. Enrico Santarelli • Hien Thu Tran *The interplay of human and social capital in shapingentrepreneurial performance: the case of Vietnam*

# The consumption pattern, Lifestyle and Hypertension on Fishermen Community

<sup>1</sup>Khodijah Ismail & <sup>2</sup>Yulia Fatma

<sup>1</sup>Maritim Raja Ali Haji University Tanjungpinang, khodijah@umrah.ac.id, (+62)82323667888

<sup>2</sup>Dinas Kesehatan Bintan Kepulauan Riau, yuliafatma04@gmail.com, (+62)81372367901

## Abstract.

Hypertension is in the first rank of tenth major diseases at inpatient and outpatient health center at regency/city of Riau Island Province. This research was conducted in Bintan regency and the majority of population are fishermen. This was a unmatched case control study. Subject of this study were hypertensive fishermen which taken from medical records of two health centers with consecutive sampling technique, comprising 137 cases (hypertensive fishermen) and 137 controls (non hypertensive fishermen). The results showed there was significant association between consumption of natrium, potassium, coffee and smooking as risk factors for the prevalence of hypertension among fishermen. Fishermen tend to have unhealthy consumption pattern and lifestyle. Generally they consume instant foods/drinks, insufficient sleep specially at night, are smokers and drink alcohol while in the sea or on shore. Therefore Informal education in the health is very important to change unhealthy lifestyle in the Fishermen Community

**Keywords:** *consumption pattern, lifestyle, hypertension, fishermen.*

## 1 Introduction

Hypertension, also known as high or raised blood pressure, is a global public health issue. It contributes to the burden of heart disease, stroke and kidney failure and premature mortality and disability. It disproportionately affects populations in low- and middle-income countries where health systems are weak. Addressing behavioural risk factors, e.g. unhealthy diet, harmful use of alcohol and physical inactivity, can prevent hypertension. Tobacco use increases the risk of complications of hypertension. If no action is taken to reduce exposure to these factors, cardiovascular disease incidence, including hypertension, will increase (WHO, 2013). Hypertension is also the highest diseases in coastal areas. One of the provinces in Indonesia, the most extensive coastal villages (84,70% or 299 villages) and regions oceans (98%) are Riau Islands Province. In 2014 at Riau Islands Province have 8.86% of poor households. And from 7 districts are 5 districts have unhealthy lifestyle behaviors below 50% and the whole district is >70% of the population is a fisherman's household (SLHD Kepri, 2014 and BPS 2014). Poverty is a cycle of social and economic events that always occur in the household fishing (Kusnadi, 2008). Of unhealthy lifestyle this can lead to an increase in blood pressure (hypertension). Fishermen has diagnosed with hypertension will decrease productivity and increase psychosocial stress. The Low productivity of fisherman cause of the fisherman household income can reduced, then the effect on household spending. The low incomes of fishermen difficult to the basic needs food and non-food basic needs such as education and health. This condition will influence to nutritional status of families of fishermen, Low access to health facilities of fisherman communities also influence this condition because they do not know for sure their health (Purwanti, 2008).

Through this study, researchers will find factors have most influence to hypertension of fisherman community. There are several risk factors of hypertension, namely: 1) Age, primary hypertension generally occurs at age 25-45 years and only 20% are under the age of 20 years and above 50 years. This is due to the productive age less attention to health and healthy lifestyles (Dhianingtyas and Hendrati, 2006); 2) Gender, at the age of men more hypertension over 65 years of age, while more women (Depkes RI, 2006); 3) Heredity, family history of hypertension had 9.5 times the risk (Miswar, 2004); 4) Physical activity, patients with primary hypertension with less physical activity have a risk 5.37 times the risk (Widada, 2008); 5) Smoking, people who smoke have a risk of 3.40 times greater risk of hypertension compared with those who do not smoke; 6) Consumption of salt, people who consume salt > 5 grams per day will increase the risk of essential hypertension 9.8 times compared

with those who consume salt <5 grams per day; 7) Consumption of dietary fiber, high protein diet and high in soluble fiber can lower blood pressure in hypertensive patients (Burke et al, 2001; Miura et al, 2004); 8) consumption of coffee, people who drink coffee every day more than once at risk of hypertension 4.52 times greater than those who rarely drink coffee; 9) Consumption of alcohol, consumption of alcohol harmful to health because it can increase catecholamine synthesis, can trigger a rise in blood pressure (Purwati et al, 2000); 10) Psychosocial stress, the stress had 8.6 times the risk for hypertension compared with those who do not stress.

## **2 Methodology**

This study is an observational analytic study using case control study without matching. Case control study design is the design of epidemiological studies that studied the relationship between the effects of (a disease or condition) with certain specific risk factors. Selection of subjects based on disease status, then observed whether the subjects had a history of exposure to risk factors or not (Sastroasmoro and Ismael, 2008). This study conducted in the sub-district of East Bintan and Gunung Kijang of Bintan regency of Riau Islands Province. These two districts have the highest fisherman households in Bintan regency. Population of study was all fishermen who are in the research area. Subjects were fishermen who meet the criteria for cases and controls. Criteria case is fisherman, male, age > 18 years, diagnosed with primary hypertension and disease other than hypertension, good communication skills, literacy, willing to participated. Control criteria is the same as the criteria of the case but did not suffer from other diseases.

## **3 Results**

### **3.1 Characteristics of fishermen**

Based on univariate analysis of categorical data and can be described numerically the frequency distribution characteristics of research subjects. The number of research subjects is 274 people consisting of 137 cases (fishermen who suffer from hypertension and 137 controls (fishermen who do not suffer from hypertension). Independent variables showed that 51.5% of 41-60 years old of fisherman with a proportion of the cases more than the control group and 48.5% of age group 18-40 years old. It shows that age influenced created of hypertension. Department of Health Report of Riau Island Province in 2008 Also Showed that the prevalence of hypertension Riau province above the national prevalence (31.7%) is 74.6% for age> 64 years old. High consumption of sodium in fishermen because often consume foods preserved (> 5 times per week) such as salted fish, noodles, sardines, tomato sauce, soy sauce, shrimp paste and others. Prevalence of people consume of the risk food in Riau Islands province is 25.2% salty foods, preserved foods 10.3%, 43.2% caffeinated food and 79.4% of spicy food flavors.

Most of fishermen from childhood to adulthood get used to consumption of salty foods and use MSG (Mono Sodium Glutamate). MSG is a source of high sodium in food flavors. Proportion of fishermen Bintan regency by consumption of coffee are higher in the case group (72.3%) compared to the control group (41.6%). This is because in addition to coffee fishermen also consume other sources of caffeine such as tea, energy drinks and soft drinks when at sea. The results showed that the number of fishermen who consume fiber and fruits are very less in the case group (50.4%) compared to the control group (42.3%). Prices of vegetables and fruits in the coastal region is relatively expensive. Bintan regency soil conditions with a high content bouksit less suitable for cultivation. Then the number of fishermen higher alcohol consumption in the control group compared to the group of cases. Fishermen consume alcohol only when sailing alone. But the proportion of smoking is higher in the case group (89.8%) compared to the control group (73.7%). The high proportion of smoking because it aims to eliminated sleepiness while sailing, cold weather as well as a sense of stress when the catch is low.

## **3.2 Relationship of consumption patterns and lifestyles with hypertension of fishermen**

### **3.2.1 Relationship of Consumption Natrium and Potassium with Hypertension of fishermen**

The results of the bivariate analysis between natrium (Na) consumption variables with hypertension showed a significant relationship with OR of 2.622 with 95% CI = 1.494 to 4.600 and *p value* of 0.001. It can concluded that the fishermen who consume more natrium will increase the risk of hypertension was 2.6 times greater. The results of the bivariate analysis between potassium (K) consumption variables with hypertension showed a significant relationship with OR of 2.622 with 95% CI = 1.494 to 4.600 and *p value* of 0.001. It can concluded that the fishermen who consume more potassium will increase the risk of hypertension was 2.6 times greater.

### **3.2.2 Relationship of Coffee Consumption with Hypertension of fishermen**

The results of the bivariate analysis between coffee consumption variables with hypertension showed a significant relationship with OR of 2.512 with 95% CI = 2.206 to 6.060 and *p value* of 0.000. It can concluded that the fishermen who consume coffee will increase the risk of hypertension by 3.6 times greater than the fishermen who do not consume coffee. When at sea, fishermen uncontrolled drinking coffee with the aim to fight the cold or hot, sleepy and tired.

### **3.2.3 Relationship of Smooking with Hypertension of fishermen**

The results of the bivariate analysis between smooking variables with hypertension showed a significant relationship with OR of 3.132 with 95% CI = 1.601 to 6.126 and *p value* of 0.001. This means is fishermen who have the habit of smoking will increase the risk of hypertension by 3.1 times greater than the fishermen who do not smoke.

### **3.2.4 Relationship of dietary fiber consumption with Hypertension of fishermen**

The results of the bivariate analysis between dietary fiber variables with hypertension showed not significant relationship with OR of 1.382 with 95% CI = 0.858 to 2.226 and *p value* of 0.183. These results show that there is no relationship between dietary fiber consumption with hypertension. Fishermen do not have the habit of eating dietary fiber and fruits because the price is expensive. Report of the Health office of Riau Islands Province in 2008 that there were 98% of this region population is still low-level of consumption of vegetables and fruits. In Bintan regency only 2.8% of the population aged 10 years and over who consume enough vegetables and fruits.

### **3.2.5 Relationship of alcohol consumption with Hypertension of fishermen**

The results of the bivariate analysis between alcohol variables with hypertension showed not significant relationship with OR of 1.092 with 95% CI = 0.679 to 1.757 and *p value* of 0.716. These results show that there is no relationship between alcohol consumption with hypertension. The results showed that the fishermen do not always consume alcohol except at sea is less than 2 cups per day at sea.

### **3.2.6 Relationship of Psychosocial stress with Hypertension of fishermen**

The results of the bivariate analysis between psychosocial stress variables with hypertension showed not significant relationship with OR of 1.173 with 95% CI = 0.536 to 2.568 and *p value* of 0.690. No significant relationship between psychosocial stress and hypertension because fishermen are in a normal psychosocial conditions or do not have a big problem. Fishermen can adapt to changes in environmental factors and is able to face with competition among people in looking for livelihood.

## 4 Conclusion

The factors that a significant relationship to hypertension of fishermen communities is coffee consumption, sodium consumption, potassium consumption, smoking lifestyle and age. Health problems significant relationship with poverty. For anticipate and resolve of the fishing community problem need to cross-sectoral co-operation both formal and informal organizations.

## 5 Acknowledgement

This article was supported by Gajah Mada University, Bintan Regency Government, Maritime Raja Ali Haji University and much helps from our colleague.

## 6 References

- Badan Pusat Statistik (BPS) Provinsi Kepulauan. (2014). Riau Islands in figures 2014. Tanjungpinang.
- Burke, V., Hodgson, J.M., Beilin, L.J., Giangiulioi, N., Rogers, P., Puddey, I.B (2001) Dietary Protein and Soluble Fiber Reduce Ambulatory Blood Pressure in Treated Hypertensives. *Hypertension*. 38: 821-826.
- Depkes RI. (2006). Pedoman Teknis Penemuan dan Tata laksana Penyakit Hipertensi. Direktorat Pengendalian Penyakit Tidak Menular. Dirjen PP & PL. Jakarta.
- Dhianingtyas, Y., Hendrati, L.Y. (2006). *The Indonesian Journal of Public Health*, 2(3), 105-109.
- Environmental Agency of Riau Islands (BLH Kepri). (2014). Regional Environmental Status of Riau Islands 2014.
- Kusnadi, M.A., (2008). Akar Kemiskinan Nelayan. Yogyakarta: LkiS
- Miswar. (2004). Faktor-faktor Resiko Terjadinya Hipertensi Esensial di Kabupaten Klaten. Tesis. Universitas Gajahmada.
- Miura, K., Greenland, P., Stamler, J., Liu, K., Daviglius, M.L., Nakagawa, H. (2004). Relation of Vegetable, Fruit and Meat Intake to 7 Year Blood Pressure Change in Middle Aged Men. *Am J Epidemiol*. 159: 572-580.
- Purwati, S., Salimar., Rahayu, S. (2000). Perencanaan Menu untuk Penderita Tekanan Darah Tinggi. Jakarta: Penebar Swadaya.
- Purwanti, P. (2008). Simulasi Kebijakan Pengembangan Ekonomi dan Ketahanan Pangan Rumah Tangga Nelayan Skala Kecil di JawaTimur. Disertasi. Universitas Brawijaya, Malang.
- Sastroasmoro, S and Ismael, S. (2008). Dasar-dasar Metodologi Penelitian Klinis, Edisi ke-3. Jakarta: Sagung Seto.
- WHO. (2013). A global brief on Hypertension. Silent killer, global public health crisis. World Health Day 2013.
- Widada, A. (2008). Hubungan antara Indeks Massa Tubuh, Asupan Natrium dan Asupan kalium dengan Derajat Hipertensi Primer pada Pasien yang Berobat di Puskesmas Moyudan, Kabupaten Sleman, Tesis, Universitas Gajah Mada.

## **Analysis of Community Empowerment For Elderly Population Quality As Human Resources in Medan**

Asfriyati<sup>1\*</sup>, Badaruddin<sup>2</sup>, Sirojuzilam<sup>3</sup>, Heru Santosa<sup>4</sup>.

1. Program Doktor Perencanaan Wilayah Pascasarjana Universitas Sumatera Utara
2. Faculty Of Social And Political Science/Sociology/Jalan Prof. Sofian No.1Medan 20155 Sumatera Utara
- 3.Faculty Of Economic, Jalan Prof. T.M. Hanafiah, Medan 20155 Sumatera Utara
- 4.Faculty Of Public Health, Jl Universitas No 21 Medan 20155 Sumatera Utara

### **Abstract**

The research goal is to analyze the empowerment of communities for the elderly population as human resources in Medan. This study uses a quantitative approach. Collecting data with primary data obtained through interviews with the elderly as well as secondary data. The analysis used for proving the hypothesis in this study is the use of a Structural Equation Model (SEM) was performed with the program Analysis of Moment Structure (AMOS). The results of the study showed that the provision of information, infrastructure, financial assistance, health services, provide jobs included in the model of community development for the elderly population as human resources and have a positive influence on the quality of the elderly population as human resources in Medan. It is expected that the government provide support such as infrastructure, finance and government to make regulations to strengthen the elderly population.

*Keywords: community empowerment, the quality of the elderly population*

### **Introduction**

Regional development requires the role of human resources. Human resources are referred to a qualified and have sufficient ability to mobilize all resources existing areas (Nachrowi and Suhandjo, 2001). Human resource development physically and mentally opportunity to participate in the process of sustainable development. Increased life expectancy will indicate the success of human development, but if life expectancy is not accompanied by the quality of the elderly, the elderly will be a burden on development. Indonesian population demographic conditions change when viewed from the age structure that leads to the elderly population. In 2010 life expectancy 67.4 years with the elderly population of 9.77%, and is expected in 2020 will reach 71.1 years with the number of elderly 11.34% (CBS, 2011).

Medan is the capital of North Sumatera province has a relatively large population. The latest data from the population census of 2010 the population of the city of Medan 2.097.610 people. Large population can provide positive and negative effects on economic growth. If most of the population such as the elderly, the unemployed do not participate to the economic activity, economic growth will be negative(Sirojuzilam,2011).

Increase in the elderly population in the city of Medan by the Central Bureau of Statistics on tahun 2012 as much as 5.8%, in 2020 and is estimated to be 6.11% (CBS, 2012). From 2010 data dependency burden of the elderly population 8 means of 100 residents aged 15-59 years will bear 8 elderly population. Potential non-elderly population (sick, do not have a family) gets help from the state budget in Medan from year 2007 to 2011 every year only 60 elderly people who were given



relief, and in 2012 assistance was provided to 171 elderly people who are potential in the district and subdistrict MarelalBelawan. Despite increased but the number of elderly who were given assistance so far from the number of elderly who are not potential in Medan (Department of Social Welfare and Labor Medan, 2013). Health programs that involve the community are elderly neighborhood health center, but from the data obtained turned out of all districts in the city of Medan number of senior citizens who served in 2010 just as much as 54.01%, where the active neighborhood health center only 31%. From the results of health care information Medan said that has not been served throughout the elderly because of the lack of infrastructure facilities elderly neighborhood health center, health workers specifically addressing the elderly (Medan City Health Office, 2011).

In 2002 formed an organization that aims to empower the elderly amid the social life of the community and to increase community participation in social development in order to remain useful and beneficial, healthy, and independent. Elderly institutions established by the Decree of the Mayor on Development To Elderly Indonesian Institute (LLI) Medan. Although City Medan government has started to do service to the elderly population that is associated with the community and family, but still not up to reach the entire population of the elderly. Because the elderly population is not only the responsibility of the government but also the responsibility of the community and the families it is necessary to find a form of community empowerment model to deal with the quality of the elderly population as human resources in Medan.

## **2. Literature Review**

### **2.1 Community empowerment**

Sumodiningrat (1996) suggested that empowerment is a process of change from dependence to the independence. Five characteristic in the implementation of community development is the stimulus capital, mentoring, support facilities and infrastructure, institutional development as well as monitoring and reporting. According Subejo and Supriyanto (2004) that empowerment is an effort to facilitate local communities in planning, deciding and managing local resources owned through collective activities and networks that have the ability and independence in economic, ecological and social. Community empowerment is addressed to the ability of people are particularly vulnerable and weak that they have the power or ability to meet basic needs, reaching the sources of production and services, participate in development and decision-making. Suhendra (2006) stated the elements of community empowerment is the political will to support, the atmosphere is conducive to developing the overall potential, motivation, community potential, opportunities are available, willingness to shift authority, protection and awareness. Homan in Adiyoso (2009) formulated the 10 elements of community empowerment, namely the development of community assets, increase individual skills, communication between citizens, linking existing resources, creating community resources, ownership, raising expectations, relations with the outside world, encouraging confidence and resilience of society, build organizational sustainability and improve the quality of life for the community. Community empowerment for elderly is incumbent on the public in accordance with Law Number 13 Year 1998 on Elderly Welfare (Elderly) explained that empowerment is any effort to improve the physical, mental, spiritual, social, knowledge, and skills to the elderly ready to be utilized in accordance with their respective capabilities.

## **2.2. The quality of the elderly population**

The quality of the elderly can be seen from various aspects such as health, economic, social. In the case of the WHO health states in elderly health care is Add life to your years as well as years to life. The concept of health of the elderly population is different from the rest of the population, there are three things that concerns the health of the elderly is the functional status, major health problems and diseases. Functional status of the interaction of physical disorders, psychological and socio-economic (Darmojo, 2009).

Suardiman (2011), which discusses the independence of older persons, independent means that the daily undergo an elderly do not depend on others. Independently in the economic sense, an independence economically, independent in terms of its ability to perform daily activities (Activities of Daily Life-ADL, self-based aspects of personality, the ability to cope with the problem, diligence, obtaining the satisfaction of its business and willing to do something without the help of others. Independent according to the Law of the Republic of Indonesia Number 13 of 1998, Article 1 and 3. Ability to independently performed only by aging potential, namely the elderly who are still capable of doing the job and produce goods or services.

According to the World Health Organization Quality of Life (WHOQOL), 1997 divides the quality of life in six domains: physical, psychological, level of independence, social relationships, environment, and spiritual / religious. Physical domain consists of 3 parts: the discomfort, fatigue and break. Psychological domain, which consists of five parts, namely positive juice, thinking, self-esteem, as well as the appearance of negative feelings. Domain degree of freedom, which consists of 4 parts: movement, daily life activities, dependence on medication or treatment, work capacity. Domain of social relations, is divided into three parts: individual relationships, social support, and social activities. Domain environment that consists of 8 parts: physical security, home environment, sources of income, health and social care, the opportunity to acquire new information and skills, recreation and leisure time, physical environment and transport. Domain spiritual / religious.

Based on theories about quality over for this study were taken relating to the quality of the elderly as human resources pertaining to efficient, health status, work activities, social relations, economic fulfillment capabilities and skills.

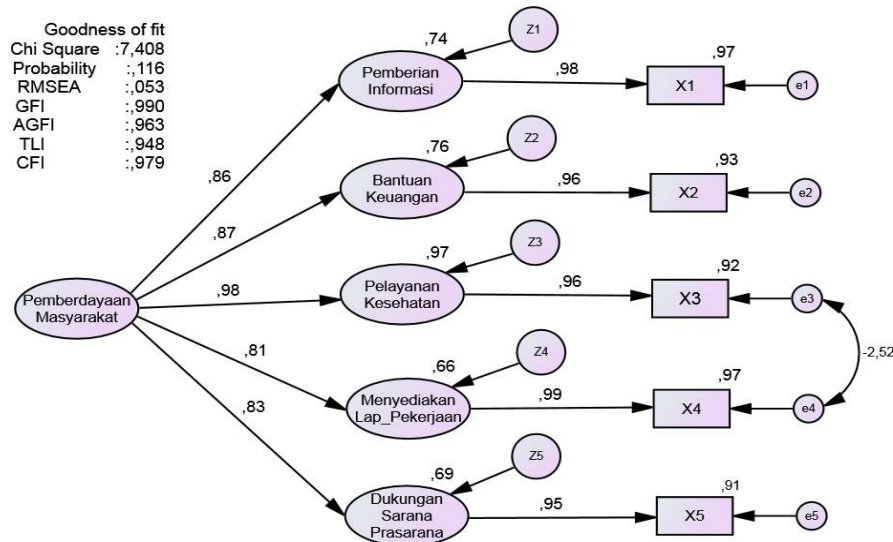
## **3. Research Methodology**

The study design is the quantitative approach. The primary data used by the method of structured interviews with interview guide (questionnaire). Data secondary data obtained from official publications in the form of an annual report from the Central Bureau of Statistics of North Sumatra Province, the Regional Development Planning Agency (Bappeda) of Medan, Medan City Health Department, Department of Social Welfare and Labor Medan, Women's Empowerment and Family Planning Medan , journals, magazines, theses, dissertations and books. The analysis used for proving the hypothesis in this study is the use of a Structural Equation Model (SEM) was performed with the program Analysis of Moment Structure (AMOS).

## 4. Results and Discussion

### 4.1. The Results

The results of the confirmatory factor analysis of data on community empowerment construct using a single indicator (composite indicator). Where the results of the analysis can be presented in Figure 1.



**Figure1**  
**Results of Confirmatory Factor Analysis**  
**Community Empowerment For Elderly Population**

Source: Data processed, 2014

The model became empowerment for the elderly population of 6 indicators providing information, financial assistance, health services, provide jobs, support infrastructure, institutional support to 5 indicators where institutional support to drop out because of the value estimate is less than 0.70, as the results in Table 1

**Table1 Standardized Regression Weights: Community Empowerment**

	Estimate
providing information <--- Community Empowerment	,880
<b>institutional support &lt;--- Community Empowerment</b>	<b>,675</b>
support infrastructure <--- Community Empowerment	,875
financial assistance <--- Community Empowerment	,896

		Estimate
provide jobs	<--- Community Empowerment	,808
health services	<--- Community Empowerment	,977
X1	<--- providing information	,984
X2	<--- financial assistance	,961
X3	<--- health services	,958
X4	<--- provide jobs	,984
X5	<--- support infrastructure	,950
X6	<--- institutional support	,965

Source: Data processed, 2014

The results of the data analysis through indeces modification can be noted, some of the important points related to the exogenous construct confirmatory factor in community development can be noted in Table 2.

**Table 2 Results of Modified On Goodness of Fit Index In Confirmatory Factor Analysis In the Community Empowerment**

<b>Kriteria</b>	<b>Indek</b>	<b>Nilai Acuan</b>	<b>Hasil Analisis</b>	<b>Hasil Evaluasi</b>
Chi Square		as small as possible	7,408	Good
P value		$\geq 0,05$	0,116	Good
CMIN/DF		$\leq 2,00$	1,852	Good
RMSEA		$\leq 0,08$	0,053	Good
GFI		Approaching 1	0,990	Good
AGFI		Approaching 1	0,963	Good
TLI		Approaching 1	0,948	Good
CFI		Approaching 1	0,979	Good

Source: Data processed, 2014

Based on Table 2 shows that the results of the goodness of fit indicates that the value of chi square is 7.408 with a significance level (P value) of 0.116, while that in determining the size of a model fit can also be seen in the value of RMSEA = 0.053, GFI = 0.990, AGFI = 0.963 , CMIN / DF = 1.852, TLI = 0.948, CFI = 0.979 and. The values of the index on the goodness of fit can be said to have met the *criteria fit* overall.

Testing hypotheses about the effect of empowerment on the quality of the elderly population as human resources indicates that the CR value of 2.614 with probability 0.008. Basic decisions where the value of  $p < 0.05$  ( $0.008 < 0.05$ ) or the value of CR greater than the critical value, the conclusion set is Community Empowerment positive

and significant effect on the improvement of quality of elderly residents in the city of Medan with the standardized coefficient of 1.823.

## **4.2. Discussion**

Indicators of institutional support is not an indicator of community empowerment for elderly residents in the city of Medan, it can be seen that the institutional in Medan has not run well. It can be seen from the data of institutions and foundations that deal with the elderly population obtained from the North Sumatra provincial social services are the foundation of achievement elderly North Sumatra, North Sumatra Province Komda elderly who have spiritual activities, library elderly, nursing home Budi Dharma Guna, Unity set Elderly GPIB, and gymnastics Art Elderly healthy heart. However, the implementation of the institutions and foundations even this is not the maximum in its implementation because it does not reach all the elderly (Department of Social Welfare and North Sumatra, 2012). When viewed from the planning agencies have goals and activities that are beneficial to improving the quality of the elderly population but due to lack of cooperation with the government and other parties, the activity becomes less than the maximum and have not touched the entire population of the elderly in the city of Medan. It would require cooperation with other parties eg the Department of Population, Department of Industry, the Ministry and the Department of Labour, Social Services, Department of Health, Industry households, private company.

The British government provides services in the form of empowerment of local and volunteer services. Mechanism of action of local empowerment and volunteer services are responsible for providing social services and protection to the elderly include shelter, family atmosphere, health, financial and other (Acheson and Hagard, 1984). The British government also provides services in the form of empowerment of local and volunteer services. Mechanism of action of local empowerment and volunteer services are responsible for providing social services and protection to the elderly include shelter, family atmosphere, health, financial and other (Acheson and Hagard, 1984).

Empowering communities to the quality of senior citizens in the city of Medan to note. Community empowerment model in this research is the provision of information, financial assistance, health services, provide employment and support infrastructure, as according Soedjono (2002); Subejo and Supriyanto (2004) that empowerment is a business that allows a society to survive (survive) in an effort to facilitate local communities in planning, deciding and managing local resources owned through collective activities and networks that have the ability and economic independence , ecological and social.

Provision of information, financial assistance to the elderly is a major source of social power of empowerment, it is appropriate according to Friedman (1992) argues that society places (3) three powers as the main source of empowerment, namely social, political and psychological. Social forces regarding access to the basics of production of a society, such as information, knowledge and skills, participation in social organizations, and financial resources. If the local economy is increased access to the basics of production above, the ability to define and achieve their goals also increased. Increased social forces can be understood as an increase in public access to the basics of their productive wealth. Research conducted by Suttipong and Pintipa (2011) empowering the community with quality of life of elderly in Bangkok that most of the elderly gain acceptance and respect of the people in the community and develop a system of Sufficiency Economy-Based Schooling. In addition, the

local community, such as education and community leaders, can analyze the problem of elderly and establish effective guidelines for developing the quality of life of elderly.

Act No. 13 of 1998 on the Welfare of Elderly (Elderly) explained that empowerment is any effort to improve the physical, mental, spiritual, social, knowledge, and skills to the elderly ready to be utilized in accordance with their respective capabilities. In accordance with the conditions and capabilities of both physical and non-physical. Some of the services to be provided is health care, infrastructure and employment. Research conducted by Setiti 2005 on kinship-based elderly care in five regions (North Sumatra, West Kalimantan, East Java, South Sulawesi and Nusa Tenggara Barat) see that Elderly Care by kinship has cultural value. The need for the elderly include health care, spiritual needs, dining needs.

## 5. Conclusion

Community empowerment model for the elderly population as human resources consist of the provision of information, financial assistance, health services, provide employment and support infrastructure while institutional support is not a model of community empowerment for the quality of the elderly population in the city of Medan. Institutional does not reach all the elderly and still need help from the government and private sectors. Community Empowerment positive and significant effect on the improvement of quality of elderly residents in the city of Medan.

## 6. Acknowledgement

The process of settlement is certainly a lot of research encountered difficulties, constraints but thanks to the help, input from various parties research can be done. For that say thank you profusely to the leadership of the University of North Sumatra, Medan city government, leaders and staff SKPDs Medan involved in research, the enumerators, the elderly, and data processing .

## References

- Acheson RM and Hagard Spencer, 1984, *Health ,Society and Medicine*,Blackwell Scientific Publication
- Abikusno, N., Haque, Z., & Giridar, G.,2007, *Older population in Indonesia: Trends, issues, and policy responses*. Papers in Population Ageing No. 3, Bangkok: UNPFA Indonesia and Country TechnicalServices Team for East and South-East Asia.
- Adiyoso Wignyo, 2009, *Menggugat Perencanaan partisipasi dalam Pemberdayaan Masyarakat*, Putra Media Nusantara, Surabaya
- Alfitri, 2011, *Community Development Teori dan Aplikasi*, Pustaka Pelajar, Yogyakarta
- Amol R Dongre dan Pradeep R Deshmukh,2012, *Social Determinants of quality of elderly life in a rurual setting of India*,Diakses 4 Desember 2013
- Ananta, Aris & Djajanegara, Siti Oemijati, 1986, *Mutu Modal Manusia: Suatu Pemikiran Mengenai Kualitas Penduduk*, Lembaga Demografi FEUI, Jakarta
- Azizah, Lilik Ma' rifatul, 2011, *Keperawatan LanjutUsia. Edisi 1*. Yogyakarta : Graha Ilmu

- Azwar, Saifuddin, 2012, *Reliabilitas dan Validitas*, Yogyakarta, Pustaka Belajar
- Badan Pusat Statistik Provinsi Sumatera Utara, 2011, *Sumatera Utara Dalam Angka 2010*.  
Badan Pusat Statistik Provinsi Sumatera Utara, Medan
- Badan Pusat Statistik Kota Medan, 2010, *Kota Medan Dalam Angka 2010*. Badan Pusat Statistik Kota Medan
- Badan Pusat Statistik Kota Medan, 2013, *Kota Medan Dalam Angka 2013*, Badan Pusat Statistik Kota Medan
- Badan kependudukan dan keluarga berencana Nasional, 2012, Data mengenai Bina Keluarga Lansia 2011
- Bastaman HD, 2007, *Logoterapi : Psikologi Untuk menemukan Makna Hidup dan Meraih Hidup Bermakna*, PT Raja Grafindo, Jakarta
- Boaz RF, et al, 1999, The tranfer of Resources From Middle-Aged Children To Functionally Limited Elderly Parent : Providing Time, Giving Money, Sharing Space, *The Gerontologist Vol 39, no 6, 648-657*. Diakses tanggal 11 April 2012
- Darmojo Boedhi, 2009, *Geriatric ( Ilmu Kesehatan Usia Lanjut )*, Balai penerbit FK UI, Jakarta
- Deputi I Menkokesra, 2007, *Lansia Masa Kini dan Mendatang*, [http:// :www Menkokesra.go.id/ content/view/2933/333](http://www.Menkokesra.go.id/content/view/2933/333). Diakses 10 Februari 2011
- Dinas Kesehatan Kota Medan, 2011, *Profil Kesehatan kota Medan Tahun 2010*, kota Medan
- Dinas Kesejahteraan dan Sosial Propinsi Sumatera Utara, 2012, Data tentang Lembaga / Yayasan yang menangani Lansia di Sumatera Utara
- Dinas Sosial dan tenaga Kerja Kota Medan, 2013, *Aktivitas Kerja Penduduk Lansia*
- Drissen. E and F. van Winden, 1992, “*Social security in a general equilibrium Model with endogenous government behaviour*” dalam Dieter Bos & Sijbren Cnossen, *Fiscal Implications on an Aging Population*, Springer-Verlag, Berlin
- Elsy Putri, 2012, *Dinamika Lansia Di Jepang*, ILUNII KWJ Press, Jakarta
- Ferdinand, A.T, 2005, *Structural Equation Modeling*, BP UNDIP, Semarang
- Friedman HS (ed), 1992, *Hostility, Copyng and Health*, American Psychological Assn : Washington DC.
- Friedman HS and Schustack M W, 2012, *Personality Classic Theories and Modern Research 5/e* MA Pearson, Boston
- Ghozali Imam, 2013, *Model Persamaan Struktural Konsep dan Aplikasi Dengan Program Amos 21.0*, Universitas Dipenogoro, Semarang
- Ginanjar K., 1997, *Pembangunan Sosial dan Pemberdayaan: Teori, Kebijakan, dan Penerapan*, Jakarta
- Setiabudhi, Tony dan Hardywinoto, 1999, *Panduan Gerontologi Tinjauan dari berbagai Aspek*, PT Gramedia Pustaka Utama, Jakarta
- Heri Mis Cicih Lilis, 2006, Apa Kata Toma Tentang Lanjut Usia, dalam *Warta Demografi Volume 36 nomor 3 hal 27- 33*
- Hurlock Elizabeth B, 2004, *Development Psychology*, Erlangga: Jakarta
- Ife, Jim dan Tesoriero, Frank, 2008, *Community Development: Alternative Pengembangan Masyarakat di Era Globalisasi*, Pustaka Belajar Yogyakarta
- Jaziroh Nur, 2008, *Studi Perbedaan Produktivitas Kerja Pada Pekerja Lansia dan Non Lansia. Tesis*
- Jonas, Steven, 1992, *An Introduction To US Care System*, Springer Publishing
- Jones C.J and Rose Debra, 2005, *Physical Activity Instruction of Older Adult*, [www.humankinetics.com/products/all-products/physical-activity](http://www.humankinetics.com/products/all-products/physical-activity) instruction of older adult.
- Kail Robert V and Cavanaugh John C, 2007, *Human Development: a life –span view*, Australia : Belmont, California

- Komisi Nasional Lanjut Usia Republik Indonesia, 2010, *Profil Penduduk Lanjut Usia Indonesia 2009*, Jakarta
- Kompas edisi Rabu 3 Desember 2014, *Penduduk Lanjut Usia Peluang Bonus Demografi Kedua*
- Kuntari Titik. *Pelayanan Kesehatan Lansia*, Departemen Ilmu Masyarakat, <http://www.Images.titikuntari.multiply.com>
- Loveridge, Scott , 2000, “Introduction to regional science”. In: *Web Book of Regional Science: An introduction to regional economics*. <http://www.rri.wvu.edu/loveridgeintroregsci.htm>. Diakses 17 Februari 2010
- Monks F.J, 2002, *Psikologi Perkembangan : Pengantar Dalam Berbagai Bagiannya*,
- Murti Bhisma, 2006, *Desain dan Ukuran Sampel Untuk Penelitian Kuantitatif dan Kualitatif di Bidang Kesehatan*, Gadjah Mada University Press, Yogyakarta
- Mutiara Erna,dkk, 2011, *Studi Identifikasi Karakteristik Dan Kebutuhan Penduduk Lanjut Usia di Kota Medan ,Sumatera Utara*
- Nachrowi dan Suhandajo, 2001, Analisis sumber daya manusia, otonomi daerah, dan pengembangan wilayah Dalam: Muchdie et al (Ed) *Tiga pilar pengembangan wilayah: Sumber daya alam, sumber daya manusia, dan teknologi*. Jakarta: Pusat Pengkajian Kebijakan Teknologi Pengembangan Wilayah BPPT
- Papalia, D.E., Old, S.W., & Feldman, R.D. 2008. *Human Development*. Newyork : McGraw-Hills
- Pemerintah Kota Medan , 2006, *Buku Rencana Pembangunan Jangka Menengah ( RPJM ) Tahun 2006 – 2010*, Medan
- Peraturan Pemerintah Nomor 43 Tahun 2004 Tentang Pelaksanaan Upaya Peningkatan Kesejahteraan Lanjut Usia
- Prawitasari J. E,1994, *Aspek Sosio Psikologi Lansia Di Indonesia*. Buletin Psikologi no 1
- Pham Thang and Lars Lindholin,2011, *Elderly care in daily living in rural Vietnam : Need and its socioeconomics determinant*, BMC Geriatrics, 2011,11: 81 Diakses 20 April 2012
- Rachmat R. Hapsara, 2004, *Pembangunan Kesehatan IndonesiaPrinsip Dasar, Kebijakan, Perencanaan dan Kajian Masa Depan*, Gadjah Mada University Press, Yogyakarta
- Rustiadi, Ernani ,dkk, 2009. *Perencanaan dan Pengembangan Wilayah*, Jakarta: Crestpent Press dan Yayasan Obor Indonesia
- Sarafino, EP, 2006, *Health Psychology : Bio Psychological Interaction*, New York Mc.Gram Hill
- Schmahl, Winfried, 1990, Demographic change and social security. Some elements of a complex relationship dalam *Journal of Population Economics*, Volume 3, Number 3, 1990, pp. 157-177
- Setiti SR, 2006, *Pelayanan Lanjut Usia Berbasis Keekerabatan ( Studi Kasus Pada Lima Wilayah Di Indonesia)*
- Sirojuzilam , 2011, *Problematika Wilayah Kota dan daerah*, Medan: USU Press
- Sirojuzilam dan Kasyfull Mahalli, 2010, *Regional: Pembangunan, Perencanaan, dan Ekonomi*. Medan: USU Press
- Smet Bart, 1994, *Psikologi Kesehatan*, PT Gramedia Widiasarana Indonesia, Jakarta
- Stiglitz,JE et al, 2011, *Mengukur Kesejahteraan*, Marjin Kiri PT Wahana Aksi Kritika
- Suardiman Siti Partini, 2011, *Psikologi Usia Lanjut*, Gajahmada University Press, Yogyakarta
- Subejo dan Supriyanto,2004, *Metodologi Pendekatan Pemberdayaan Masyarakat*,Dewan Mahasiswa Fakultas Pertanian UGM, Yogyakarta.
- Sudjarwo dan Basrowi, 2009, *Manajemen Penelitian Sosial*, Sumbersari Indah, Bandung



- Sugiyono, 2002, *Statistik untuk Penelitian*, Alfabeta, Bandung
- Suhartini Ratna, 2004, *Faktor-Faktor Yang Mempengaruhi Kemandirian Orang Lanjut Usia*, Universitas Pasca Sarjana UNAIR, Surabaya. [http //: www. Damandiri .or.id](http://www.Damandiri.or.id). Diakses tanggal 10 Februari 2011
- Suhendra, K. 2006. *Peranan Birokrasi dalam Pemberdayaan Masyarakat*. Alfabeta: Bandung.
- Suhrcke Marc, Martin MsKee, Lorenzo Rocco, 2007, *Health Investment benefits economic development*, WHO European Office for Investment for Health and Development, Vol 307
- Sukamdi dkk, 2000, Kondisi Sosial Ekonomi Dan Perawatan Yang diinginkan Penduduk Lansia, dalam *Buletin penelitian kebijakan kependudukan Volume 11 nomor 1*, Hal 35-58
- Sumodiningrat, Gunawan (1996), *Pembangunan Daerah dan Pemberdayaan Masyarakat*. Jakarta, Bina Reka Pariwisata.
- Sutisna Endang S, 2012, *Pemberdayaan Masyarakat di Bidang Kesehatan Teori dan Implementasi*, Gadjah Mada University Press, Yogyakarta
- Suttipong Boonphadung and Pintipa Seubsang , 2011, *Sustainable Development of the Life Quality for t, he Elderly by Applying Sufficiency Economy-Based Schooling*, Thailand, [www.ipedr.com](http://www.ipedr.com) /.../001-ICEMT2012-C00023. Diakses pada tanggal 20 Oktober 2012
- Tarigan, Robinson, 2008, *Perencanaan Pembangunan Wilayah, ed. ke-2*. Jakarta: Bumi Aksara
- Taylor, S., 2009, *Health Psychology*, 3<sup>rd</sup> Singapore , Mc Grow Hill Inc
- Tjiptoherijanto dan Budhi, 1994, *Ekonomi Kesehatan*, Penerbit Rineka cipta, Jakarta
- Trihandini Indang, 2007, Potret Buram Pelayanan Kesehatan Lanjut Usia Di Indonesia dalam *Jurnal Kesehatan Masyarakat Vol no 5 April 2007* di akses 8 Februari 2010. [http://:www.fkm.Ul.ac.id](http://www.fkm.Ul.ac.id)
- Undang-Undang Republik Indonesia Nomor 13 Tahun 1998 tentang Kesejahteraan Lanjut Usia
- Undang-Undang Republik Indonesia Nomor 25 Tahun 2004 tentang Sistem Perencanaan Pembangunan Wilayah
- Wijaya Tony, 2009, *Analisis Structural Equation Modeling Menggunakan AMOS*, Universitas Atma Jaya, Yogyakarta
- World Health Organization, 1997, *WHOQOL Measuring Quality of life*: Division of Mental Health and Prevention of substances Abus, WHO
- Wrihatnolo R.R dan Dwidjowijoto R N, 2007, *Manajemen Pemberdayaan Sebuah Pengantar dan Panduan Untuk Pemberdayaan Masyarakat*, Gramedia Jakarta
- [www.mediaIndonesia.com/read/2011/01/27/198895/68/11](http://www.mediaIndonesia.com/read/2011/01/27/198895/68/11)
- [www.ncbi.nlm.nih.gov/books/NBK98379/](http://www.ncbi.nlm.nih.gov/books/NBK98379/), 2001, *Preparing for an aging world. The case for cross National Research* , Washington DC , The National Academic Press
- Zen, M. T., 2001, “Falsafah dasar pengembangan wilayah: Memberdayakan manusia”. Dalam: Muchdie et al (Ed) *Tiga Pilar Pengembangan Wilayah: Sumber daya alam, sumber daya manusia, dan teknologi*. Jakarta: Pusat Pengkajian Kebijakan Teknologi Pengembangan Wilayah BPPT.

# **CORPORATE SOCIAL RESPONSIBILITY POLICIES IN DEVELOPING POSITIVE IMAGE ON HIGHER EDUCATION INSTITUTION AT TANRI ABENG UNIVERSITY, JAKARTA, INDONESIA**

**<sup>1</sup>Erna Mariana Susilowardhani & <sup>2</sup>Narti Eka Putri**

<sup>1</sup>Tanri Abeng University, Jakarta; e-mail: [ernams.erna@gmail.com](mailto:ernams.erna@gmail.com); Mobile +62 8121960912

<sup>2</sup>Tanri Abeng University, Jakarta; e-mail: [nartinandaadi@yahoo.com](mailto:nartinandaadi@yahoo.com); Mobile: +62 89687660997

## **Abstract**

An institution's concern is required to make a positive contribution to the environment in which the institution exist. Moreover, if the institution wants to achieve a target of competing in the global era, including in this case the higher education institution. This is what the authors want to focus on. As a relatively new higher institution, Tanri Abeng University seeks to build a positive image through CSR (Corporate Social Responsibility). To that end, the authors would like to know the CSR policy that is applied by Tanri Abeng University in developing a positive image. The concepts we use are the concept of Organizational Communication, Corporate Social Responsibility, and positive image. The authors use descriptive qualitative approach in this research. To obtain the required data, the authors conducted observation and in-depth interviews to a number of respondents who had been determined before. Triangulation of sources and methods we use to check the validity of the degree of confidence as a technique of data. The results is Tanri Abeng University conduct policies in running their CSR program, with an emphasis on education. The initiative CSR program that Tanri Abeng University made is Cause Promotions and Corporate Philanthropy.

**Keywords:** CSR (Corporate Social Responsibility) Policy, Positive Image, Tanri Abeng University

## **1. INTRODUCTION**

Higher Education as a public good is the responsibility of all stakeholders, especially governments. Faced with the complexity of current and future global challenges, higher education has the social responsibility to advance our understanding of multifaceted issues, which involve social, economic, scientific, and cultural dimensions and our ability to respond to them. It should lead society in generating global knowledge to address global challenges. Higher education institutions, through their core functions (research, teaching, and service to the community) carried out in the context of institutional autonomy and academic freedom, should increase their interdisciplinary focus and promote critical thinking and active citizenship. This would contribute to sustainable development, peace, well-being, and the realization of human rights, including gender equity. Higher education must not only give solid skills for the present and future world but must also contribute to the education of ethical citizens committed to the construction of peace, the defense of human rights and the values of democracy. There is need for greater information, openness, and transparency regarding the different missions and performance of individual institutions. Autonomy is a necessary requirement for fulfilling institutional missions through quality, relevance, efficiency, transparency and social responsibility (UNESCO 2009).

The higher education institution in Indonesia is categorized into two types: public and private. There are four types of higher education institution: universities, institutes, academies, and polytechnics. Indonesia's institutions of higher education have experienced dramatic growth since independence. In 1950 there were 10 institutions of higher learning with a total of about 6,500 students. In 1970, 450 private and state institutions enrolled about 237,000 students, and by 1990 there were 900 institutions with about 141,000 teachers and nearly 1.5 million students. By 2009 there were 2,975 institutions of higher education and more than 4.2 million students. Of these institutions, 3 percent were public, with 57.1 percent of the student enrollment, and 97 percent were private, with 42.9 of the student enrollment. Even though government subsidies finance approximately 80 to 90 percent of state-

university budgets, universities have considerably more autonomy in curriculum and internal structure than do primary and secondary schools. Whereas, tuition in such state institutions is more affordable than private-university tuition, enabling attendance by students from relatively modest backgrounds, faculty salaries are low by international standards. Lecturers often have other jobs outside the university to supplement their wages.

Private universities are generally operated by foundations. Unlike state universities, private institutions have budgets that are almost entirely tuition-driven. A one time registration fee (which can be quite high) is determined at the time of entry. Universities with a religious affiliation may receive donations or grants from religious organisations. The government provides only limited scholarship support for students wishing to attend private universities.

Tanri Abeng University (Acronym: TAU) is a private university founded in 2012 by entrepreneur and former Minister of State-Owned Enterprises in the Development Cabinet and the Development Reform Cabinet, Mr. Tanri Abeng. It is located in Ulujami, South Jakarta, Indonesia. TAU itself is a Boutique University equipped with varied model of lecture rooms, among others, library, theater, auditorium, research and publication center, counseling and career center, language Center and other facilities.

As a new institution, it is certainly reasonable if not many people aware of the existence of Tanri Abeng University. Various promotional activities are necessary to raise public awareness of its existence. However, apart from that, the main mission as one of the institutions in the field of education, particularly higher education, issues related to social responsibility to the public institutions, of course, still needs to be prioritized. Not only related to social responsibility itself, but it is quite possible that it also related to promotional activities. All are made relating to social responsibility, will certainly impact on the positive image of the institution, especially the new one such as Tanri Abeng University.

From the background stated above, the authors are interested in examining the CSR policy that is applied by Tanri Abeng University in developing a positive image.

## **2. LITERATURE REVIEW**

### **2.1 Organizational Communication**

According to Pace and Faules (2001:31), "organizational communication can be defined as performances and interpretation of messages between communication units which are part of the particular organization". An organization consisting of communication units in the relationship between the hierarchical relationship with other and function in the environment. Organizational communication occurs whenever at least one those who occupy a position within an organization interpret a performance. Communication that occurs within the organization and between organizations can be formal or informal, internal or external. So organizational communication which will be discussed in this research is formal internal organizational communication.

Doldhaber (as cited in Muhammad 2009:67) define organization communication as a process to create and to exchange message in the condition where everyone is related to one another in term of uncertain and keep on changes environment. Thus, communication should be implemented regularly, externally as well as internally, to ensure that the message or information was well delivered to the recipient. Communication is another way as an emerging driver for organization activities. Organization could not run well without engaging good communication (Suminar, Soemirat & Ardianto 2009:3)

While, external communication is two way communications between people inside the organization with the public outside the organization (Suminar, Soemirat & Ardianto 2009:27).Main purposes of external communication are to maintain good relationship, to create beneficially public opinion, to maintain positive organization image (Suminar, Soemirat & Ardianto 2009:27).

## **2.2 Corporate Social Responsibility**

### **2.2.1 Definition of Corporate Social Responsibility (CSR) and CSR in a Higher Education**

Corporate social responsibility is a commitment to improve community well-being through discretionary business practices and contributions of corporate resources (Kotler and Lee, 2005:3). Corporate Social Responsibility (CSR) may be defined as the actions of an organization that are targeted toward achieving a social benefit over and above maximizing profits for its shareholders and meeting all its legal obligations. The corporation is operating in a competitive environment and that the managers of the corporation are committed to an aggressive growth strategy while complying with all federal, state, and local legal obligations (Ghillyer 2012).

In the current global market environment, the social pressures on businesses have increased and the concern for the CSR is not manifested only by academics but by the public and the shareholders as well (Popa 2010). Unfortunately many companies awoke to the importance of CSR only after being surprised by public responses to issues they had not previously thought were part of their business responsibilities (Porter and Kramer 2006). Especially after the negative public responses and global boycotts, there has been a trend toward promoting corporate changes and CSR implications that has associated with business strategies of the companies (Filho et al. 2010). Moreover, in the implementation process, companies had realized that, if used properly, CSR strategies can be profitable and create value propositions such as competitive advantage and corporate reputation (Smith 2007, Porter and Kramer 2006, Husted and Allen 2001).

Since higher education institutions have begun to behave in a business-like manner, they also need to be managed in the same manner. Therefore implementing CSR strategies in a higher education institution should be considered in order to obtain a true competitive advantage and a positive reputation. Moreover practicing what is taught and thereby generating a real example of the academic knowledge can create a unique proposition for any higher education institution. Besides, as the complexity of higher education operations increasingly overlap with societal interests, higher education institutions are pressured for responsible practices. Thus responsible higher education practices not only will contribute to the well-being of the shareholders and the public in general, but also these practices will increasingly become a long-term value proposition for the institution itself.

### **2.2.2 The Stages of Policies on Corporate Social Responsibility**

Managers and program planners are challenged at each of the fundamental decision points identified throughout this book—decisions related to choosing a social issue, selecting an initiative to support this issue, developing and implementing program plans, and evaluating outcomes. (Kotler and Lee, 2005:18).

#### **Choosing a Social Issue**

Challenges are perhaps the greatest in this very first step, as experience has shown that some social issues are a better fit than others, and this first decision has the greatest impact on subsequent programs and outcomes. Those making the recommendations will end up juggling competing priorities and publics. (Kotler and Lee, 2005:18).

#### **Selecting an Initiative to Address the Issue**

Once an issue has been chosen, managers will be challenged regarding recommendations on what initiative or initiatives to support the issue. (Kotler and Lee, 2005:19).

#### **Developing and Implementing Program Plans**

Key decisions at this point include whether to partner with others and, if so, with whom; determining key strategies, including communications and distribution channels; assigning roles and responsibilities; developing timetables; and determining budget allocations and funding sources. (Kotler and Lee, 2005:20).

## **Evaluation**

Ongoing measurement of marketing activities and financial investments for corporations has a long record, with decades of experience in building sophisticated tracking systems and databases that provide analysis of returns on investments and compare current activities to benchmarks and "gold standards." By contrast, the science of measuring return on investments in corporate social initiatives is very young, with little historic data and expertise. Marketing professionals and academic experts in the field confirm this challenge. (Kotler and Lee, 2005:21).

### **2.2.3 The Six Social Initiatives Programs on Corporate Social Responsibility**

The six social initiatives explored are as follows (Kotler and Lee, 2005:23-24):

**1. Cause Promotions:** A corporation provides funds, in-kind contributions, or other corporate resources to increase awareness and concern about a social cause or to support fundraising, participation, or volunteer recruitment for a cause. The corporation may initiate and manage the promotion on its own.

**2. Cause-Related Marketing:** A corporation commits to making a contribution or donating a percentage of revenues to a specific cause based on product sales. Most commonly this offer is for an announced period of time, for a specific product, and for a specified charity. In this scenario, a corporation is most often partnered with a nonprofit organization, creating a mutually beneficial relationship designed to increase sales of a particular product and to generate financial support for the charity.

**3. Corporate Social Marketing:** A corporation supports the development and/or implementation of a behavior change campaign intended to improve public health, safety, the environment, or community well-being. The distinguishing feature is the behavior change focus, which differentiates it from cause promotions that focus on supporting awareness, fundraising, and volunteer recruitment for a cause. A corporation may develop and implement a behavior change campaign on its own (i.e., Philip Morris encouraging parents to talk with their kids about tobacco use), but more often it involves partners in public sector agencies.

**4. Corporate Philanthropy:** A corporation makes a direct contribution to a charity or cause, most often in the form of cash grants, donations, and/or in-kind services. This initiative is perhaps the most traditional of all corporate social initiatives and for many decades was approached in a responsive, even ad hoc manner. More corporations are now experiencing pressures, both internally and externally, to move to a more strategic approach, choosing a focus and tying philanthropic activities to the company's business goals and objectives.

**5. Community Volunteering:** A corporation supports and encourages employees, retail partners, and/or franchise members to volunteer their time to support local community organizations and causes. This activity may be a stand-alone effort (i.e., employees of a high tech company tutoring youth in middle schools on computer skills) or it may be done in partnership with a nonprofit organization (Shell employees working with The Ocean Conservancy on a beach cleanup). Volunteer activities may be organized by the corporation, or employees may choose their own activities and receive support from the company through such means as paid time off and volunteer database matching programs.

**6. Socially Responsible Business Practices:** A corporation adopts and conducts discretionary business practices and investments that support social causes to improve community well-being and protect the environment. Initiatives may be conceived of and implemented by the organization (i.e., Kraft deciding to eliminate all in-school marketing) or they may be in partnership with others (Starbucks working with Conservation International to support farmers to minimize impact on their local environments).

### **2.3. Corporate Image**

Image is how others see a company, a person, a committee or an activity. Each company has earned as much as the number of people who look at it (Ardianto, 2011:62). The task of the company in forming its image is to identify the image it wants to set up in the eye of its public or community (Ardianto, 2011:62).

Image not only consists of a single reality which is held by an individual, but also those who are holding a series of interconnected picture consisting of many elements or objects that are attached and are interpreted through language (Oliver, 2001:52).

A reality can be perceived differently by each individual and can also be perceived differently by different members of society (Wasesa and McNamara, 2010:55). Therefore, to obtain the image that the company management desire, we need to understand precisely what kind of selection process that happen in the public when they receive information about the reality of what happened (Wasesa and McNamara, 2010:55). Thus, the extent to which the image is formed entirely be determined by how Public Relations able to build a perception that is based by the reality of what happened (Wasesa and McNamara, 2010:55).

Good image of an organization is a very important asset, because the image has an impact on consumers' perceptions and organizations' operation in a variety of ways (Nova, 2011:302).

There are various opinions on the company's image presented by communication experts. Mark Graham R. Dewney (in Nova, 2011:301) says that the image of the company is an overall impression of the company that is in the consumers' mind. According to Jeffkins (in Nova, 2011:301) the company's image is defined as the character of an organization.

While R Smith defines the company's image as a number of perception about an organization (the Nova, 2011: 301). In line with Smith, Lawrence L. Steinmentz also defines the company's image as the public perception about the company identity. The public perception about the company is based on what they know or think of the company (in Nova, 2011:301).

Image is the main goal Ana also a reputation and accomplishments to be achieved by Public Relations' community. The understanding of the image itself is abstract and can not be measured systematically, but its form can be felt from the results of the assessment, whether the assessment is good or bad. (Ruslan, 2008:75).

Steinments (as cited in Nova 2011, p.301) define organization image as a community perception to company based on what they might acknowledge or they might heard.

From the definition that has been described above, it can be concluded that the real image can be designed in such a way that it creates a perception which is desired by the public. The perception that is desired by every institution is certainly a positive one, so the attached image is also a positive image.

Although the definitions mentioned above tend to talk about the company, but the author argues, the definition of the image can also be applicable to all institutions, including higher education institution. Higher Education which has a good image, of course will make people confidence highly to the educational institution. In the end, they will entrust this institution as a highly competent institutions that can support the good quality education for their children. This, of course, is based on the existing realities of the educational institution, where after seen, heard, and observed, then later the public will perceive the institution.

### **3. METHODOLOGY**

In this study, researchers used a qualitative approach. The purpose of qualitative research is more *descriptive* than *predictive*. The goal is to understand, in depth, the viewpoint of a research participant. Realizing that all understanding is constructed, different research participants are going to have different interpretations of their own experience and the social systems within which they

interact. Moreover, the researcher is going to impose his or her cultural, social, and personal identity on any interpretation of the research participants' experience. (VanderStoep and Johnston, 2009:167).

Qualitative researchers seek to preserve and analyze the situated form, content and experience of social action, rather than subject it to mathematical or other formal transformations. Two researches in communication that normally used qualitative research are development communication and the production of content in media organizations (Lindlof & Taylor 2002, p.18). As noted by Kriyantono (2012, p.56), qualitative research aims to explain the deepest phenomenon through in-depth data collection.

As a nature of the research, the authors used descriptive research. Descriptive research presents a picture of the specific details of a situation, social setting, or relationship (Neuman, 2014:38). A descriptive research study starts with a well-defined issue or question and tries to describe it accurately. The study's outcome is a detailed picture of the issue or answer to the research question (Neuman, 2014:38-39). A descriptive study presents a picture of types of people or of social activities and focuses on "how" and "who" questions (How often does it happen? Who is involved?). Exploring new issues or explaining why something happens (Neuman, 2014:39).

Qualitative researchers employ several methods for collecting empirical materials (Denzin and Lincoln (Editors), 2005:25). Data collection techniques are the most strategic step in the research, since the main goal of the study is to obtain data (Sugiyono, 2011:224). As the primary data, researchers conducted in-depth interviews. In-depth interviews are a means of collecting data or information by the way of a direct face to face with the informant in order to obtain complete data and in-depth (Kriyantono, 2012:102).

Another common qualitative research technique is direct observation. The ultimate tradeoff between interview and observation techniques is reliance on participants' perceptions or reliance on the researcher's perceptions. (VanderStoep and Johnston, 2009:238). According to Kriyantono, observation is defined as the activity to observe directly—without a mediator—the object to see closely the activities which are carried out by the object itself (Kriyantono, 2012:110).

For secondary data, researchers conducted a literature study. Researchers use the appropriate literature and relevant to this research.

In obtaining the data from the interviews, the researchers interviewed a number of informants. The informant is a person or a member of a group that are researched. They are expected to have important information (Kriyantono, 2012:101). Informants were selected based on criteria that have been set earlier by researchers. Their information is expected to add the discourse on the topics according to the study.

From the data obtained, the researchers then perform the processing of the data and then analyze it. Data analysis is performed at any time in collecting data on the field with an ongoing basis (Bungin (Ed) 2008:154). Meanwhile according to Bogdan & Biklen (in Irawan, 2007:70), the data analysis is the process of systematically finding and arranging the interview transcripts, field notes, and other materials that you get, all of which you collect to improve your understanding (against a phenomenon) and help you to present your findings to others.

To maintain the quality of this research, the researchers used a validity technique of data. Data validation techniques that researchers used is trustworthiness. Trustworthiness is to test the truth and honesty in expressing the reality of the subject according to what is experienced, perceived, or imagined (Kriyantono, 2012:71).

Trustworthiness include two things, namely the authenticity and triangulation. In this study, researchers use triangulation. Surveyors and sailors measure distances between objects by taking observations from multiple positions. By observing the object from several different angles or viewpoints, the surveyors and sailors can obtain a good fix on an object's true location. Social researchers employ a similar process of triangulation. In social research, we build on the principle that we learn more by observing from multiple perspectives than by looking from only a single perspective. (Neuman, 2014:166).

Triangulation, expanded beyond the psychometric definition of multiple measures to include multiple data sources, methods, and theoretical schemes, is critical in establishing data trustworthiness. It is

essential that the research design seek counter patterns as well as convergences if data are to be credible. (Lincoln and Denzin (Editors), 2003:191).

According to Dwidjowinoto (in Kriyantono, 2012:72-73), there are several kinds of triangulation, ie triangulation of source, triangulation of time, triangulation of theory, triangulation of researcher, and triangulation of methods. In this study, researchers use a triangulation of method and triangulation of source.

Triangulation of method is an attempt to check the validity of the data or check the validity of research findings. Triangulation method can be done by using more than one data collection techniques to get the same (Dwidjowinoto in Kriyantono, 2012:73). Researchers use the triangulation of method is to match what the informant expressed and comparing by the observations of researchers. Meanwhile triangulation of source, researchers compare or cross-check the informations among the informants.

## **4. RESULTS**

In this section, the authors describe the findings related to the theme that is adopted in this research.

### **4.1 Corporate Social Responsibility Program Policies**

After collecting the data, the authors reduce and make categorization related to the concept that the authors refer, that is from Kotler and Lee (2005) regarding the policy measures of Corporate Social Responsibility (CSR):

#### **1. Choosing A Social Issue**

As an institution engaged in education, Tanri Abeng University (TAU) puts more emphasis on education as a social issue. Moreover, it is one of TAU's missions to participate in the intellectual life of the nation and also to give the equity in education. In this case, TAU participates in supporting government to expand the access to get a better life by providing the opportunities for senior high school students from various areas in Indonesia and have financial constraint to pursue higher education in TAU.

Still engaged in education, TAU also makes a visit to orphanage and give the orphans financial support for their education.

Not only the management, the member of TAU's communities also participate in educating the people. They give English Lesson to underprivileged students who live around TAU campus.

#### **2. Selecting An Initiative To Support This Issue**

The Government encourages every organization to perform CSR programs, including the higher education institutions such as Tanri Abeng University. As described above, in implementing CSR policies, TAU concentrates in the field of education. That becomes the reason TAU participates in supporting government to expand the access to get a better life by providing the opportunities for senior high school students from various areas in Indonesia to pursue higher education in TAU.

In selecting the students, TAU prioritizes the quality of the candidates, not the quantity. If the candidate is a prospective student, but he cannot afford to pay tuition fee, TAU seeks to accommodate him to pursue higher education in TAU by involving him in a scholarship program.

In addition to the scholarship program, TAU also performs social activities that are incidental or at certain moments. One of those activities is visiting orphanages and providing them not only daily materials they usually need but also their educational cost that support their education.

However, as a new institution that was founded 3 years ago, TAU is still working hard to introduce the institution to the public. Many efforts are made to achieve this. One of the efforts is collaborating with tutoring institution "Primagama". TAU made cooperation with Primagama in carrying on the free try-out program for high school students grade 3 who will



take National Examination and will be a freshman. This collaborative effort also carried out in recruiting outstanding students. Five students who get the highest score will get exemption fee of 75 percent of the tuition fee if they register as a freshman in TAU.

From the above explanation, educational assistance and scholarships given by Tanri Abeng University, based on a referral from Kotler and Lee, 2005, are classified as initiatives of corporate philanthropy programs. While free try-out program that is undertaken in collaboration with tutoring institution "Primagama" can be categorized as a cause promotions program.

### **3. Developing And Implementing Program Plans**

In carrying out the CSR program, TAU creates regular programs and incidental programs. As mentioned previously, the incidental programs are visiting the orphanage and giving donation to orphans to support their education. For regular programs, every new academic year TAU provides scholarship for outstanding senior high school students who register as a freshman.

Anakukang Foundation which operates TAU takes advantage of its relationships with other institutions to become a partner, especially in relation to financial assistance for scholarship program. For example, TAU collaborates with the PLN (State Electricity Company) and PELINDO to give scholarship to outstanding students from Papua. They will receive scholarship if they can reach a certain GPA. Every semester, TAU has to make a report to PLN and PELINDO about the students' achievement. It is expected that the students who receive scholarships can be more responsible and make good use of the scholarship. In the future, students from Papua financed by PLN and PELINDO, pursue to be able to work in the institution after graduation.

In informing the scholarship program and as an effort to attract prospective outstanding students from all provinces in Indonesia, as a part of its CSR program policies, TAU uses official website as a communication channel to disseminate the information. TAU also conducts road shows to the targeted areas in Indonesia and those events are used also to select prospective outstanding students.

### **4. Evaluating Outcomes**

In every CSR activities, since related to other parties (stakeholders), evaluative actions are necessarily needed as a form of accountability to the stakeholders. In collaborating program with PLN and PELINDO, TAU always makes a report. That accountability report is regularly conducted at the end of each semester. The aspects that are measured in that report cover the financial aspect, the expenditure of funds that have been done, academic aspect, the progress of the study (achievement) obtained by the scholars.

Accountability reports that are made regularly can increase the confidence of the stakeholders who support TAU financially in implementing its CSR programs. And for other CSR programs, evaluating the programs regularly can provide feedback to top management, in this case the rector of TAU, to take decisions related to the primary purposes of conducting CSR Programs. Evaluation is conducted in relation to the effect of the image of CSR program that arise in the community. It is expected that the formed image is a very positive one which has deep effect on the sustainability of the good quality institution.

#### **4.2 The Formed Image of the Implemented CSR Programs**

Social responsibility which is run by an institution, if it is done continuously, can give a positive impact on the institution, especially, if that activity is a positive one and contributes many benefits for many people.

Program Initiative which has been run by TAU is Cause Promotions Program and Corporate Philanthropy Program. For a Cause Promotions Program, TAU entered into a collaboration with Tutoring Institution "Primagama" in conducting free Try-Out for senior high school students grade 3, providing motivation for them in facing National Examination and giving them explanation of the importance of higher education for their future. The activity was held at TAU and conducted in 2 sessions. At the first session, it was followed by 528 students from 16 schools and at the second

session, it was followed by 409 students from 12 schools. With that number of Try Out participants, more and more people will know and aware of the existence of TAU. Moreover TAU provides 5 scholarships for Try-Out participants who got the 5 best Try-Out score.

From the interviews with the participants, most of them had never heard before about TAU and that was their first time to visit or just passing by TAU. They greatly appreciate the activities carried out by TAU as it gave them many benefits in the field of education. By participating in Try-Out program, they can measure their academic abilities, so they know their own potential. This greatly assists them in selecting study program which is appropriate to their academic ability.

Their expression is consistent with the definition proposed by Ardianto that is "The task of the company in forming its image is to identify the image it wants to set up in the eye of its public or community". TAU has successfully set good image on participants' mind.

Besides, by using the existing class-rooms in TAU to accommodate the implementation of Try-Out program, making them more familiar about TAU. They were very impressed with the infrastructure owned by TAU, which would support the qualified learning process.

That program is one of promotional efforts wrapped with TAU's CSR activities. As a relatively new institution, there are only a few people aware of its existence. That's why Cause Promotions program should be more intensively implemented, so that more people will know about TAU.

Meanwhile, for Corporate Philanthropy program, TAU provides scholarships for outstanding students but have financial constraints. From interviews with the scholars, they were greatly helped by the program and they are very grateful to TAU. One of their expressions to form their gratitude to TAU is their willingness to help TAU in implementing CSR programs, such as visiting the orphanage.

Besides, they even take the initiative to form a group that provides English teaching to underprivileged children who live around TAU. The children and their parents are very happy with their program because they can get many benefits from it.

Those activities will certainly make people more confidence in TAU's concern about better education and TAU's commitment on educational equity for students for a better future. They will appreciate with what TAU has done to them.

## **5. CONCLUSIONS**

From the research, it was found that in pursuing CSR, TAU implements the following steps: The first step is social issues setting. As a higher institution, TAU focuses education as the main target for its CSR program.

The second step is determining program initiative that will be carried out. TAU determines Cause Promotion Programs and Corporate Philanthropy Programs as initiative programs. The third step is to develop and implement programs that have been planned. In this case TAU set the execution time (regular and incidental), sources of funds obtained from the cooperation with other parties, and communication channel by using the official website of TAU and also having road shows to many provinces in Indonesia. The last step is evaluation. TAU makes accountability reports associated with the use of funds and also the achievement of the scholarship recipients.

Related to Cause Promotions Programs, more and more people nowadays aware of the existence of Tanri Abeng University and its promotion programs as well. Meanwhile for Corporate Philanthropy Programs, especially for the scholarship recipients, generate a positive image because of TAU's concern on them in getting the access to obtain a high quality education.

## REFERENCES

- Ardianto, Elvinaro. (2011). *Handbook of Public Relations: Pengantar Komprehensif*. Bandung: Simbiosis Rekatama Media.
- Bungin, Burhan (Ed).(2008). *Metodologi Penelitian Kualitatif*. Jakarta: PT Rajagrafindo Persada.
- Denzin, Norman K. and Yvonna S. Lincoln (Editors). (2005). *The Sage Handbook of Qualitative Research. Third Edition*. Thousand Oaks: Sage Publications, Inc.
- Irawan, Prasetya. (2007). *Penelitian Kualitatif & Kuantitatif untuk Ilmu-Ilmu Sosial*. Depok:Departemen Ilmu Administrasi FISIP Universitas Indonesia.
- Kotler, Philip and Nancy Lee. (2005). *Corporate Social Responsibility: Doing the Most Good for Your Company and Your Cause*. New Jersey: John Wiley & Sons, Inc.
- Kriyantono, Rahmat. (2012). *Teknik Praktis Riset Komunikasi*. Jakarta:Kencana Prenada Media Group.
- Lincoln, Yvonna S. and Norman K. Denzin. (Editors). (2003). *Turning Points in Qualitative Research*. California: Altamira Press.
- Lindlof, Thomas & Taylor, Bryna. (2002). *Qualitative Communication Research Methods*, 2<sup>nd</sup> Edition. California: Sage Publications.
- Muhammad, Arni. (2009). *Komunikasi Organisasi*. Jakarta: Bumi Aksara.
- Neuman, W. Lawrence. (2014). *Social Research Methods: Qualitative and Quantitative Approaches. Seventh Edition*. Essex: Pearson Education Limited.
- Nova, Firsan. (2011). *Crisis Public Relations*. Jakarta: PT Raja Grafindo Persada.
- Oliver, Sandra. (2001). *Strategi Public Relations*. Jakarta: Esensi (Erlangga Group).
- Ruslan, Rosady. (2008). *Manajemen Public Relations dan Media Komunikasi*. Jakarta: PT Raja Grafindo Persada.
- Sugiyono. (2011). *Metode Penelitian Kuantitatif, Kualitatif, dan R&D*. Bandung: Penerbit Alfabeta.
- Suminar, Jenny Ratna, Soleh Soemirat, & Elvinaro Ardianto. (2009). *Komunikasi Organisasi*. Edisi ke-2. Jakarta: Penerbit Universitas Terbuka.
- VanderStoep, Scott W., and Deirdre D. Johnston. (2009). *Research Methods for Everyday Life: Blending Qualitative and Quantitative Approaches*. San Fransisco: John Wiley & Sons, Inc.
- Wasesa, Silih Agung and Jim Mcnamara. (2010). *Strategi Public Relations*. Jakarta: Penerbit PT Gramedia Pustaka Utama.

### Journal Paper Reference

- UNESCO. (2009). World Conference on Higher Education: The New Dynamics of Higher Education and Research for Societal Change and Development, p. 2-3.

## **ACKNOWLEDGEMENTS**

The authors would like to thank to Tanri Abeng University, especially to Mr. Tanri Abeng for funding our research and supporting our attendance in this conference. The authors also would like to thank to the book and journal authors for enrich constructive data about this paper. This is a joint research between first and second author who come from two different major.

## **AUTHORS DETAILS**

### **Erna Mariana Susilowardhani, S.Sos., M.Si. (1<sup>st</sup> author)**

Lecturer in the Department of Communication Studies

Tanri Abeng University, Jakarta, Indonesia

Email: [ernams.erna@gmail.com](mailto:ernams.erna@gmail.com)

Mobile: +62 8121960912

### **Narti Eka Putri, S.Sos., M.Si. (2<sup>nd</sup> author & correspondence)**

Lecturer in the Department of Accounting Studies

Tanri Abeng University, Jakarta, Indonesia

Email: [nartinandaadi@yahoo.com](mailto:nartinandaadi@yahoo.com)

Mobile: +62 896 87660997

## **The Development of Social Capital BMT in Ciamis and Bantul Regencies (Human Resource and Leadership)**

*Dr. Suraya, M. Si., M.M*  
*Lecturer at University of Paramadina Jakarta*  
*Head of Paramadina Graduate School of Communication*

### **ABSTRACT**

This research aims to (1) synthesize behavioral change of farmers in Ciamis and Bantul in managing their communications and analyze the major components of communications on the farmers that make up communication events that are effective in developing social capital of BMT. (2) devise strategies of developing effective communication patterns in developing the social capital of farmers and BMT. This study uses qualitative research, which emphasizes understanding the phenomenon of what is experienced by research subjects such as behavior, perception, motivation, action, etc., holistically, and by way of description in the form of words and language. The results of the result show that (1) the process of social contraction in rural areas (Bantul) and sub urban area (Ciamis) begins when the farmer has motivation to interact with BMT. Three motives arise: economic incentives (capital), Spiritual (Islamic) and social motives. Farmers self-concept is a reflection of the human capital assharia farmers, namely: openness, trustful and *tawadhu*(humble), *Tabliq*, helpful, afraid of *Riba*, keep his word and healthy spirit and body. (2) The process of communication that occurs between BMT and the farmers are dialogical communication, listening, understanding and occurs through face to face communication, group communication (discussion, training, mentoring, teaching), organizational communication (annual members' meeting) and even, in BMT Miftahussalam, through the internet. They use not only verbal communication but also non verbal symbols. Non-verbal communication can be seen from the gesture, expression or facial expression which is friendly and always smiling so farmers feel comfortable communicating with BMT. Interaction between BMT and the farmers uses trust communication. When farmers are getting into Islamic financing, then BMT should provide guidance and training to customers who obtain the finance method. Training and assistance can be in the form of mental, technical and management. If all of these are implemented there will be any changes in the self as an individual farmer. This change will happen if he undertake communication acts. Communication action is mainly in the form of interpersonal communication through verbal and nonverbal communication that prioritizes communication competence. Competent communication actions will affect social change. Social changes that increase will affect the welfare of society. This is done by BMT in the suburban area that reach a maximum well-being. This is different from BMT in the rural areas, which do not conduct training and guidance so that the maximum welfare is obtained.

Keyword : Communication Model, Social Reality Construction, Social Capital, BMT

## INTRODUCTION

The Indonesian Law enactment of UU 22/1999 that distribute autonomy to the local government has given the opportunity for regencies and cities to take their independency in developing each region by referring to the principles of democracy, role and participation of the society, also equity and justice while putting concern on the potentials and diversities in the regencies to optimize the utilization of local resources. As the matter of fact, we still witness many of social issues such as conflict, violence, and terrorism that deliver negative impact toward the social capital, in which resulting the nation's character degradation like honesty, solidarity, justice, unity, and other important cultural values that necessarily needed to escalate the steadiness of the nation's unity and integrity. In response to this matter, such efforts to nourish social capital should be done based on our role in local institution, and it is expected to be widely outspread up to the global institution.

Creative and innovative human capitals will assuredly produce creative and innovative leaders. The roles of these leaders are to generate some innovative social capital. Social capital is very much related to the individual skills in performing social relations that will bring him or her to the advancement. The characters of leadership that require in performing such individual skills are charismatic and reliant. Moreover, a leader should look up to the leadership characteristics of Muhammad Prophet, in which are; (1) *Sidiq*, one must always speak the truth, followed by attitudes and behavior, consistent, objective, that align with justice; (2) *Amanah*, one must able to maintain the trust given and to keep the promises; (3) *Tabligh*, one must deliver everything as transparent as it should be to the people and the nation; (4) *Fathonah*, one must be emotionally, spiritually, and intellectually intelligent.

According Miller and Steinberg (2002) while people are communicating; it appears the concept of trust—a central or a main concept in conceptualization in developing relationship. They stated that an *interpersonal relationship* would only be marked when there is an existing sense of trust to the specific people. Littlejohn and Foss (2008) explained about the theories within the phenomenology tradition are assuming that people are actively interpreting their experiences and understanding the world based on their self-experience. In further explanation, the term phenomenon is referred to the appearance of receiving objects, events or conditions. This research was based on phenomenology tradition to look at an Islamic financial institution builds relationships with the farmers and the leaders while financing their activities and distributing credits. BMT develop relationship through interpersonal communications, group communications, organization communication and mass communication via Internet.

Social Capital is a form of the society consisting with human capital with their own unique points; each individual member of society is developing relationships by interacting and doing social transaction that will naturally established social structure. Mangkuprawira (2008) also mentioned about interpersonal skill is one of the most important soft skills of communication pattern. A person with advance interpersonal

communication is described as his or her skill in directing, motivating, and able to cooperate effectively with other individual. In addition, he or she is able to understand other people's thinking very well. The key to acquire such skill is simply based on self-awareness; to be a person with an advance interpersonal skill, one should be able to understand himself, his own feeling, his own faith, his own value, his attitude, his perception on surrounding environment and motivation to obtain something that needs to be done, in order to be able to understand other people. All these matters will help a person to accept the fact that each individual is different in terms of skill and ability, belief, value, and desire.

Structural Capital could also be referred as supporting infrastructure, organization's data base and process that enabling human capital to run its function. Structural capital includes building, hardware, software, process, patent, and copyright. Moreover, it also includes organization image, information system, and proprietary database. And due to all this variety, the structural capital could be clarified further as the innovation, process, and organization capital.

The indicator of social capital level (Mulyandari and Sumardjo, 2010), are based on the following aspects; (1) The aspect of togetherness between individuals within the society to fulfill the life existence; (2) To what extent does the member of the society know, want, and able to use their leisure time to become valuable, productive time, and even yielding money. An individual status in the society is commonly obtained from his or her achievement after the struggle through learning process—both formally or informally, and rewarded with achieved status. (3) To what extent does the networking system is able to imply the principal of helping each other, benefiting each other, and the strong help the weak, and flourish within social system of the society. (4) Social trust that indicate the spirit to appreciate, to respect, and to recognize the existence and rights between the members of the society.

Human capital and Social capital in the agriculture industry are the capitals to be utilized to attain the objective of the farming community welfare. According to Sumardjo (1999), the definition of good quality human capital of farmer is a farmer who is independent, able to take the right decision in managing his farming activities without having to rely or subordinated by other party, able to adapt optimally and innovative toward occurring changes on both social and physical environment, and also able to cooperate with external party in a mutually benefit situation that resulting interdependency. Independent farmer also described as the one with efficient attitude and has the sense of high competitiveness. Efficient attitude means to think and to act with positive attitude in using any appropriate means efficiently. While high competitiveness attitude would include the sense of producing high quality work and consumer's satisfaction of any product or service as the outcome of one thinking and act. A farmer with such independency is characterized from these 3 characters; (1) *Capability*, one must own competent, innovative, self-reliance, and self-confidence character. (2) *Trust Independence*, which is required for the development of capability; (3) *Partnership Networks*, based on egalitarian, synergy, and interdependent.

Ahmad (2005) added his thought on quality farmer that describing *amanah* farmer is characterized as; (1) *Tawadhu*, or literally means humble, one is fully realized that their succeed in harvesting their farms, through the entire process of preparation, planting, nurturing, and harvesting are the gift from the mighty God, Allah SWT; (2) *Grateful*, being grateful to Allah SWT for His gifts and graces by admitting and aware for every success that he achieved is given by the Lord and to continue optimizing the gifts and graces is by intensifying his obedience to Allah SWT; (3) *Zakat and Shodaqoh*, a religious form of giving back or charity, taken from part of the total earning from the harvest production and be given to the people in need with sincere heart and without being forced by any party; (4) To realize that the whole point of his working activity is another form worship to Allah SWT, and it is not an activity to fulfill family target or government target, therefore a hard work is required for the livelihood that given by Allah SWT; (5) Be patience to overcome the hard times in life; (6) *Tawakal*, for the result from every activities that have been done at best, based on sincerity and prayers, with a strong belief that everything is happened by the God's will. The efforts to train those farmers intensively, continuously, and systematically are required to generate such *Amanah* farmers. The entire stakeholders including; government, private sectors, community-based institutions, and the society, must actively involved in the mechanism of dialogical communication pattern.

Leadership in the modern Javanese culture is depicted on the leadership act of Ki Hajar Dewantara, who introduced the three infamous leadership philosophies into one unit of aggregation; *ing ngarso sung tulodo, ing madyo mangun karso, tut wuri handayani*. First, *Ngarso* means 'front', while *tulodo* means 'example'. The first sentence of the philosophy is interpreted, as 'a leader must become a good example'. Second, *madya* means 'middle', *mangun* means 'conforming the necessity', and *karsa* means 'willing'. The second sentence of the philosophy is interpreted, as 'a leader should be able to conform, concern, maintain, motivate, and sustain the necessity and willing of the superior and the inferior in an equal balance'. Third, *tut wuri* means 'follow', *handayani* means 'strength'. The third sentence of the philosophy is interpreted, as 'a leader should be able to educate the followers by showing them direction, motivate them with strength, and provide them the sense of security, and not by spoiling them'. Moeljono (in Djohan, 2007) stated that the basic premise of Javanese leadership philosophy is "to lead is an obligation, and devotion is not a right. Therefore, we must lead with a pure heart".

According Salahuddin (2010) there are three expressions in Sundanese (West Java) culture that becomes the standards to become a leader; *Nyantri, Nyakola, and Nyunda*. *Nyantri* means a leader should own a spiritual intellect. Spiritual became a fixed price for the last fortress for a leader to realizing that one leadership is a mandate that must be accountable to the people. *Nyakola* is a symbol of someone that put the mind as the priority, than the physical; meaning a mind that never stop to think. *Nyunda* is a diction that means a pact of Sundanese values that must be owned by the leaders and the future leaders. *Nyunda* depicts a figure of leader that able to blend with the people sincerely (*ngumawula ka wayahna*), a person with a good



behavior (*teu ningkah*), a person who does not own the act of arrogance (*teu adigung kamagungan*), a person who does not like to be praised in grandeur (*teu paya agreng-agreng*), wise and fair (*agung maklum serta adil*), and will not do any corruption (*cadu basilat*).

Social capital is also influenced by the environment condition of the society. This society environment is commonly called as 'The Local Wisdom'. After the economic crisis that hit Indonesia since 1997, it has given Indonesian some positive impacts; one of them is the birth of local wisdom in some of Indonesia societies. According to Sultan Hamengku Buwono X (2009), there are three main problems that faced by Indonesian farmers; First, the weakness of social capital; Second, the high number of poverty; and third, the damage of agriculture capital that still getting bigger. Some examples of the required social capital are law enforcement, and decentralization of government that extended to the level of village. The orientation of the 2025 agricultural development's vision should have been changed from non-agriculture industry— footloose and city bias, to become an agriculture based industry that takes side for the villagers. The local wisdoms are being understood, as the human efforts in using their cognition to act and to respond at something, like objects, or events that occurred in certain space. The word 'Local' is specifically referred to an interaction space that is limited to value system, which also has its limitation. The local wisdom as a space for interaction has been designed with lots of consideration, which involving the relationships pattern between humans, or human and the physical environment. The establishment of a life setting will produce values, which become the relationship principals or behavior references for the local community.

## **The Study**

The very definition of such terminology 'intellectual capital' in this paper would be referred to the Islamic-individual character that lies within the farmer's individuality. Knowledge sharing is one form of the farmer's characters during farmer discussion group (BMT AL Barokah) and farmer workshop & training session (BMT Miftahussalam). Such character is called *Tabligh*. It is the character of a farmer who always receives and spread good information during the discussion and training sessions.

*Tabligh*, literally means to deliver (message). In Islam, the prophets deliver all the words of God aimed for the human. A Muslim farmer is supposed to speak in manner with proper words to be said and listened; to say a sentence that contain with good advice in order to right the wrong thing, to appreciate other's work though the result is anything less than perfect, to be brave enough to speak up the truth though it is not easy to admit, and other forms of actions that put the value of *Tabligh* to his or her surroundings. The intellectual character could also be seen through a farmer's participation in an organization. The farmer's informants are affiliated with Islamic Organizations such as; Muhamadiyah and Nahdlatul Ulama (NU). These

Muhamadiyah cadres are the founder of BMT Al Barokah, including the one in Ciamis Regency.

In this research, the Emotional Capital is referred to be *Amanah*, an Islamic fundamental concept, and might as well consider as the soul of religion. The Islamic Syariah Economic System believed to be run smoothly only if the entire stakeholders practice the act of *Amanah*. *Amanah* will be the determinant factor for God to give us our livelihood. *Tawadhu* or humble, to realize that our success through the entire process of farming from the preparation, planting, nurturing, to harvesting are due to the help of Allah Swt. It is important to praise our gratefulness to Allah for every gifts and grace He has given to us, by admitting and realizing that the success we earned is coming from Allah Swt, and to optimizing our devotions and our faith to Allah Swt.

Next, the Resilient Capital is referred to be *At-ta'awwun* (to help each other) and *At-takaful* (to share the burdens). These two characters are mentioned in the philosophy of **Profit and Loss Sharing**, meaning that sharing both profit and loss become the major concern in Islamic Sharia Economy activities.

To keep the promise, as it written in the Holy Koran QS Al Maidah: 1 "O you who have believed, fulfill (all) contracts." Also in QS Al Isra: 34, "And do not approach the property of an orphan, except in the way that is best, until he reaches maturity. And fulfill (every) commitment." The contract between BMT and the customer financing is a contract of Islamic Finance; therefore each party shall fulfill their commitments. The farmer as the customer financing must fulfill the commitment to pay the installment of payment and the loan capital to BMT.

The farmer shows the Moral Capital by avoiding usury (*Riba*) in any way. Farmer shall be eerie to the things that are forbidden (*Haram*) by the religion. Farmer refuses to be involved in a contract with conventional banks because they believe there is *Riba* within their operation. In QS Al-Baqarah: 278-279, the people who believed are ordered to leave any form of *Riba* behind, even though the percentage is small. Allah SWT and Rasulullah SAW are urging those who believed, to fight anyone who is still using the instrument of *Riba* within the economy activity, which means Allah SWT will close the door of blessings and lucks, and that the forbidden status of *Riba* is final.

The Health Capital refers to physical health that owned by the farmers. As it stated in Al Quran QS At Tin: 4, "We have certainly created man in the best of stature." As the Prophet of Muhammad SAW spoke, "Verily, I (Muhammad) was sent to enhance morals, manners, and behaviors (HR Ahmad Baihaqi and Hakim). Farmer who owns a physical good will also own a good soul. Farmer who maintains his physical health will be able to nurture his farmland and livestock. If a farmer has a healthy physic then he will have a good mind as well.

The Social and Human Capital that meet the requirements above, is the result of concept and technique application of the right and effective human development approach. The proper communication is one of the important aspects in human development to support the realization of high quality social and human capital. Quality people have the potential to be the leader in the society. According Max Weber (2007) a leader has a charismatic character. A charismatic leader able to see the asymmetries power relations between those who lead and those who be leaded. The charisma that attached to the leader is the result of people's perception towards their leader that the leader has; a distinctive character from ordinary people, some kind of super power more than usual people, or at least he owns a great power.

According to Islam, leaders in certain level of position is *Amanah*, of which etymologically means straight and honest. *Amanah* could also be defined as trust. Trust is one of the very important social capitals in realizing social living. The Social Capital is a resource that owns by a person that is being utilized to build mutual social network that will benefit himself or herself, and also the community. The Social Capital is related to personal ability to do social relations to bring him or her to advancement. Such individual ability is to be a charismatic leader and *Amanah* (trust). A leader should followed the leadership act of Prophet Muhammad; (1) *Sidiq*—to keep the words, the attitude and the manner, consistent, objective, and in line with justice; (2) *Amanah*—able to keep people trust and fulfill the promise; (3) *Tabligh*—to inform anything that's become people's right to be acknowledged; (4) *Fathonah*—to be spiritually and emotionally intellectual.

A leader must be honest and consistent in his words and acts. *Amanah* means a leader must be able to keep people's mandate that has been given to him or her. *Tabligh* means a leader who has intellectual capital and always shares his or her experiences with the people. *Fathonah* means a leader should be religious and has intellectuality based on experiences. The concept of Islamic farmer character is explained on the diagram below;



Picture 1. The Concept of Islamic Farmer's Characters

## LEADERSHIP IN CIAMIS

Leadership in Ciamis could be seen through individuals who own the leadership characteristic as an independent farmer. A farmer must be able to nurture his farmland and manage his financial in order to grow and be independent. Each own farmer should always have the willing to change and move forward by participating the entire activities that organized by Farmer Community or BMT. BMT collaborates with Farmer Community in holding regular activities for the farmers once in two weeks.

The character of human is based on human capitals, which are intellectual capital, emotional capital, resilient capital, moral capital, and health capital. The majority of farmer's education in Cijeunjing is either Elementary School graduate (6<sup>th</sup> grade) or Junior High school graduate (9<sup>th</sup> grade). Nevertheless, despite their low educational level, they have many experiences in agricultural area. These farmers are averagely in their productive ages between 31 to 70 years old. The knowledge about agriculture was earned from the family legacy; also they learned it from the society and environment in the place where they live. If analyzed through the emotional capital, the collective culture and regular meeting of the farmer community are actually playing important role in positively fostering the social interaction skill with other people, which in further will help these farmers to have a very good emotional control and to understand other people's emotion very well. It is very common to see a farmer who owns the resilient capital. Such capital is easily to recognize through the way farmers are facing the impact of global warming. The uncertainty of changing weathers often-causing failure of rice harvest. In this case, farmers are showing resilient act and try to find solution together with the farmer community. The recommended solution that is given by farmer community and BMT is to change the plants, meaning during rainy season the farmers are suggested to plant the rice, while during dry season they are suggested to plant corn. In fact, some of the farmers are only planting corn because such plant could grow under rain and heat. This tactic is proved to help succeeding the harvest, and bring profit to the farmers. This analysis of moral capital could explain that almost all farmers in Cijeunjing Regency are Muslims. Moreover, even though these farmers pray as a Muslim, BMT Miftahussalam is not letting them to do it on their own. BMT Miftahussalam also provides psychology training to deepen and strengthen the farmers' knowledge in running Islamic sharia, especially on their responsibilities to pay the debts, the forbidden rules of *Riba*, etc. Therefore, the farmers are expected to be fully responsible to have the sense of belonging toward BMT Miftahussalam, and they will pay the debt responsibly while advancing BMT Miftahussalam together. Based on the observation during this research, these farmers are seemed to show their hard work in nurturing their farm field and also their livestock. It is also proving that these farmers have a good physical capital.

Meanwhile, if seeing through the figure of this particular farmer community's leader, he (US) has the charisma, despite his age of 58, he still continues to be the leader of the community. The reasons why do the rest of farmer community's members always choose him to be the leader are because people are respect him as an elder person, people are admitting his wealth in experiences, he has a wide network, and he has rich knowledge in agriculture and religion. US always brings up innovation in agriculture area, becomes the pioneer in corn planting in his district to survive planting season until harvest moon during rainy and dry seasons. In his testimony, US admits, "It was rather hard to change common behavior of the 50 members of this community to start planting corn. After I started to plant corn in 1990, few of them were started to follow me in planting the corn, after they saw the quality of the corn that I harvest were constantly good."

US himself is very active in agricultural and religious activities. “I have been farming since I was a little, because my parents were as well farmers. Since 1970s, I have already experiencing how to plant onions, chilies, rice, and corns,” said US. Right in front of his house, there is a little mosque where US always stop by to pray, and often he use it as a place to discuss with the members of farmer community.

Head of BMT Miftahussalam, DDN, has been in charge since 1995 with some list of notable milestones under his regime, especially the improvement of financial and assets report on the Chapter IV that reported; the customers have been increased significantly from 1,179 in the year of 2006 to 2,387 in the year of 2010. The total assets in 2006 were as much as IDR 591,465,378.48 in 2006, surging to IDR 2,440,146,172.42 in 2010. DDN fresh ideas to develop the society in Cijeunjing, especially the customers of BMT Miftahussalam are seen through the intense training he organized to prepare the farmer to become independent farmer. In October 26, 2009, while celebrating the World Food Day, the Governor of West Java, Ahmad Heriawan, awarded Yayasan Miftahussalam for their efforts and role in preserving food safety for the local society. Dadan Apip Hamdan received this award on behalf Yayasan Miftahussalam, and it has become a motivation for BMT to continue spreading positivity that will benefit society.

The practice of leadership in Miftahussalam reflects the Sundanese Leadership Philosophy; First, *Nyantri*—BMT exist within the environment of Islamic boarding school (*Pesantren*) therefore the leaders of BMT always held the activities the way *Pesantren* does in their daily lives. They always do the compulsory 5 times a day prayer (*Sholat 5 waktu*) together (*berjamaah*) in *Pesantren*'s mosque, blended with surrounding society, including the farmers who are the customers financing of BMT. The spiritual capital that owned by the leaders and members of this farmer community became the basic principal to guide their act of *Amanah* and responsible—*Amanah* in fulfilling their duties and in managing their income and Islamic financing. Second of all, *Nyakola*, the leader of BMT earned his postgraduate degree in Management. He always highlights creative ideas and always come up with innovations for development of BMT. Thirdly, *Nyunda*, every morning and in the afternoon, BMT leader always visit customer's house or farm field to greet them, although they often meet and talk in the mosque. Based on the Intellectual Capital, this leader constantly does the knowledge sharing with the members of farmer community, either on the regular based of once in two weeks, or during his visit to the member's house or farm field.

The leadership of US as the leader for the farmer community could be analyzed through the factor of *Nyantri*. Since US at his young age, he was actively participate in Muhammadiyah Organization and helping the kids in surrounding him to build Mosques and Madrasah School in the neighborhood he was living in. In refer to these; we could see through his character that his spiritual intellect has been structured since his young age until now. As the leader of the farmer community, this person really serve the community with *Amanah* by understanding the character's of the member in the community, so that he can tell which members who are suitable to be given and forwarded the *Amanah*. This leader will responsible of his decision and management

to the members of the farmer community and BMT. On the perspective of *Nyakola*, although this farmer does not hold the bachelor degree, but he already has enough experience and knowledge that he earn through some visits of comparative studies from other countries and regions, like Thailand and Jakarta, to the Regency of Cijeunjing Ciamis. This farmer took the advantage from such visits, and life learned experience continuously, until he finally got to the decision of planting corn instead of rice, because corn plant could survive on most kind of weathers. The decision he took was based on firm argument and logic, also followed by his fellow members of the farmer community to plant corn. *Nyunda*, US has gathered his organization figured since his participation in Organisasi Kepemudaan (Youth Organization) and Muhamadiyah that made him easily blend in with the society and able to clearly understand the society character in his surrounding. He is very low profile. Up until now he is still in charge as the leader of the farmer community and the society put some high respects toward him.

## **LEADERSHIP IN BANTUL**

The human capital in Bantul Regency is seen through the majority level of the farmer's last education is either Elementary School (6<sup>th</sup> Grade) or Junior High school (9<sup>th</sup> Grade). Most of these farmers are on their productivity ages in the range between 31 to 70 years old. Although their formal education level considered to be low, yet these farmers have rich experience in agricultural work. The farmer community in Bantul also organized agricultural training once in a month for the member of the community. However, BMT in Bantul never educate or hold socialization to the customers. The analysis on the emotional capital in Bantul case, the farmer society here has the ability to control emotion and understand other people's emotion. On the other hand, the interaction between the members in farmer community tends to be less positive, while the farmers seem to have hesitation to interact with BMT. This condition is the result of the less familiar relationship between the farmers and BMT; also there is no strong sense of belonging. In fact, the customers of BMT are delightedly come to the Annual Members Meeting (RAT) because the event provides door prize for the incentive, not because self-call.

The resilient capital could be seen through the resigned act of these farmers towards the process in nurturing and harvesting their farmland and livestock. The researcher did not witness any innovation during the observation. These farmers only nurture and maintain their farmland just as the same as how it began. The entire customers of BMT Al Barokah are Muslims. The farmers are preaching accordingly to the teaching and their understanding of Islam. Here in Bantul, they were learning the teaching of Muhamadiyah Islam, which has been introduced in the region since 1928. Such Muhamadiyah Islamic teaching also becomes the majority in the Special region of Yogyakarta. During the observation for this research, the farmers' look passionately nurturing their farmland and take care of their livestock, despite their

variety of ages or gender, they always start their days very early in the morning. This proved that the farmers have a good physical capital.

The leadership in this regency was seen in DJ (74 years old) who has been experiencing in agriculture work since 1970. He established the farmer community and farmer coop in the same year when he began his work as a farmer, though it was not run optimally. In 1999, DJ collaborated with PINBUK Yogyakarta to established Islamic Farmer Coop—the forerunner of BMT Al Barokah that still running up until now. DJ has been in the agricultural industry for a quite long time, and that makes him very fluent to explain about agriculture. He is very keen to organize lots of training for the farmer community, whether it is individually organized training or collaborating with other agency or government official (e.g.; Department of Agriculture, PINBUK, Coop, etc.). He also pioneers in planting organic rice, and to merge the management of livestock and farmland by using organic fertilizer from the livestock animal waste for the farmland, while the straw from the farmland is being used to feed the livestock animal. In fact, DJ got a little disappointed with his members that do not follow his suggestion and instead they prefer to use chemical fertilizer because it is easier to get.

DJ as a Muhamadiyah Activist, is quite well known in Yogyakarta, as a figure who consistently preaching his religion. “I have been joining Muhamadiyah since 1928, and by adopting Muhamadiyah way of thinking, I hope BMT will be easier to be accepted by the community”, said DJ. His idea to establish Islamic Coop in aimed to avoid Riba and other banking operational procedure that is against Islamic teaching has been considerate for quite a while, hence when PINBUK offered Islamic operational procedure, he was enthusiastically welcomed the idea and had immediate discussion to establish BMT to help the farmer in providing capital. The obstacle lies on the human resources issue to help managing BMT—DJ was aware that he is too old to manage BMT by himself in a long term. He wished that he could take the role as the supervisor of BMT operational to make sure that it will run the operational according to Islamic finance law consistently.

“In order to apply the syaria system in managing this Coop, we have formed a system of BMT pattern. This Coop/BMT was the first ever to establish in Bantul, that specifically intended to support the farmers and agriculture industry in this Regency,” explained DJ. In the end of 2008, SK—the Head of BMT was appointed by PINBUK to meet President of Republic of Indonesia, Susilo Bambang Yudhoyono, in Jakarta, on behalf of BMT, along with the other nation’s agricultural figures and players of about 600 people. Up to this day, especially in Desa Blawong, every Sabtu *Legi*(Javanese calendar method), they hold a gathering of famer communities for two hours; usually the event starts at from 10 A.M. to 12 P.M.GMT+0700. The agenda of this gathering is to discuss about any urgent and regular issues, on the time when there is no issue to discuss then the discussion time will be used by the agricultural instructor for knowledge sharing. DJ, as the head of farmer community, has always led the Farmer Gathering. His leadership is analyzed to be a leadership based on his charisma. DJ has a good competency both in agricultural sector and also in Islamic sharia economic. Thus, a good duet between his competency and experiences, have

made the people to decide that DJ is the perfect leader for the farmer community in their region, up until now.

Meanwhile, the BMT Al Barokah is currently led by a woman, SK (38 years old), with an educational background of Bachelor Economy graduating from Indonesia Islamic University (UII) through the major of development studies. Since the day she joined BMT Al Barokah, she has put a significant contribution in pushing BMT Al Barokah forward by gaining its assets. She applies a Standard Operating Procedure (SOP) for the operational implementation of BMT based on the instruction given by PINBUK, though on its implication in the field is getting done with the so-called kinship system. If some people of BMT are not capable to finish certain work or there is too much work during over time period, then the other fellow colleagues in BMT must help each other. The BMT also assigned all the staffs in BMT to take part in BMT's marketing team. The idea to develop BMT is not just limited to be a financial agency to provide savings and loans, but to become the Real Sector Unit (USR) that is responsible in conducting trading activities. The USR does not just selling fertilizer, pesticides, but also the spray equipment and other equipment that will be needed in the future by the members of farmer community and also the customers of BMT Al Barokah. Since SK took the leadership, there has been an increase number of BMT's customer for as much as 1,032 customers in 2010, increasing from just 258 customers in 2003. The increasing number is also seen on BMT's asset for as much as IDR 1,066,620,487 in 2010, increasing from just IDR 128,647,355 in 2003.

To be analyzed further, SK always shows a patience act on he leadership toward BMT Al Barokah, which according to the philosophy of Javanese leadership it is due to her natural instinct as a woman. Even though her regular days are full of working and picking up her children at school, but SK neverwhine or complain about it. SK has earned the respect as a leader due to her prestigious charisma from her subordinates, and she never against the decision of the BMT's board of advisors. SK also blends very well with the community and her subordinate even though she spend lesser time in doing public relations with the customers because she has trusted that specific task is belong to the marketing department. BMT's marketing system took the proactive approach with the customers, and intentionally compelling its marketing department to be familiar with the customers. During a crisis situation like report dateline or there is a customer who delinquently pay the installment on time, SK tends to be very calm to overcome the situation as she trusted her team that they are able to handle the situation. In fact, SK would give her team or subordinates some suggestions to help them in completing their task before the deadline is approaching. At the moment, SK took one policy to hold the BMT's expansion, with the reason that she and the team could focus in giving *Sharia* capital funding to help more farmers. In the downside of SK leadership, she tends to have this typical Javanese character called *Nrimo* (it means, one has the tendency to genuinely accept anything that happens in her life without any contra dictionary act at all), so her leadership looks very monotonous by just following the ordinary daily activities' flows, which resulting a very slow business development progress on BMT Al Barokah. Thus, SK

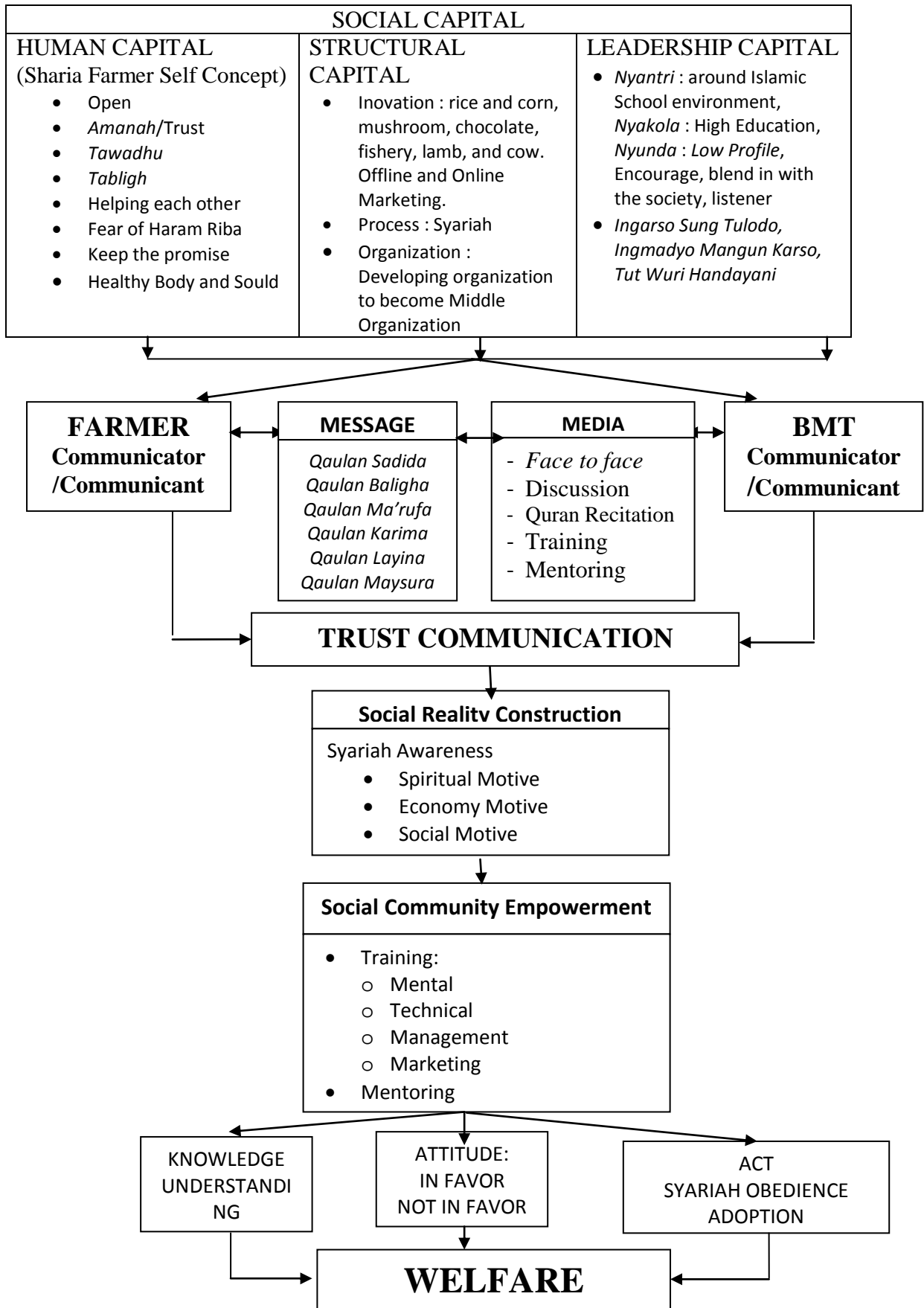


is still chosen and respected as the leader of BMT Al Barokah because there has not been any regeneration that is able to fill her position as the next and a better leader for BMT Al Barokah.

The characteristic of Farmer Community Leader, DJ, shows some leader characteristics, such as; *first*, a persistent personality and has a strong stance. These first characteristics are seen through his words and attitudes on behavior changing in persistently shifting the use of urea fertilizer into compost fertilizer, although the other members are still not yet following him, but he is proving that his harvest quality are topping compared to other farmers who used urea fertilizer. DJ really wants to show the farmer that merging the management between planting and dealing with the livestock is actually the very essence of farming activity itself. Furthermore, DJ is not just giving insights and lectures to the member of Farmer Community about the importance of using compost fertilizer and the dangerous of using urea fertilizer, but he actually shows them through his own actual practice. *Secondly*, DJ is always be respected by the members of Farmer Community because he owns the prestigious charisma as a leader. He even, for several times, receives acknowledgement and honor from the government in regional or national level, as the ideal model of good farmer. He teaches discipline to the member who violates the rules and do not meet the target. For example, the failure of Farmer Coop operational that causing the declining capital, DJ would dismiss the management members who causing the failure and they no longer invited inside the management of BMT Al Barokah. *Thirdly*, in his age that is no longer young, he still enthusiastically get his hand dirty with his field work himself in the farm, and whenever he meet any member of the farmer community in the middle of the farm, he would love to spend his time to discuss and listen to the members about any aspiration or need directly from them. *Fourth*, DJ always show a calm attitude because of his charisma, and never got his temper to control him, which makes the members always trust him and his decision. Nevertheless, the decision that he made has always come up though deliberation or open forum with the members of the farmer community that make it a transparent and joint decision that will benefit the members. *Fifth*, he always listens to the members of the farmer community, and transparently brings any occurring issue to the forum table, so the community could discuss about possible solution together. *Sixth*, DJ always makes a good role model of an ideal farmer to the members of the farmer community, especially in doing the farming fieldwork, showing them that whatever we do should be done at our best so we could get the best result at the end of our work, and he always willing to share his knowledge on farming through a technical training although it is not well-scheduled.

The role of leadership becomes a center point in fostering and developing social capital, both in Ciamis Regency, as well in Bantul Regency. The leader should be able to escalate the standard living of his members through the sharia financial support from BMT. Furthermore, BMT should enhance the productivity on the farming activities of the members, so that the farmers are not only receiving financial support, but also mental support in utilizing their farmland. The leader brings the member to be unite as a team by putting trust on each other, and have some healthy competition

in achieving a welfare life as an independent farmer. The communication system in BMT's Social Capital Development are described on below diagram:



## PROPOSITION

BMT in developing social capital among the farmers, is very much rely to the function of networks, which is the relation between individuals that trusting each other, and the norm that rules collaboration network. The social capital contains with human capital, structural capital, and leadership capital. Human capital consist of; intellectual capital, emotional capital, patience capital, moral capital, and health capital. Human capital will establish self concept within the individual. The farmer self concept consist of: open, *amanah*/trust, *tawadhu*, *tabligh*, helping each other, fear of *haram riba*, keep the promise, and healthy body & soul. This social capital will establish collaboration network that later will shape the structural capital. Human capital and structural capital will develop leadership capital. As an individual creature, a farmer would naturally own a leadership character. Each individual, as the member of the farmer community and the local society, also creating a group of network that has a leader within that circle. Such individual leader of group leader is the definition of leadership capital.

The structural capital of Ciamis society consists of inovation towards land management in cultivating rice and corn, mushroom, chocolate, fishery, lamb, and cow. This innovation also not limited to marketing activity, both offline and online marketing. BMT runs its operational process under sharia financial law. At first, BMT Organization is an Islamic Boarding School based organization, which later develop into community-based organization that devoted for middle to lower income society. The society in Bantul has not yet shown any innovation or development on their sharia product or their farming product for their Structural capital. Meanwhile, the operational process of BMT under sharia financial law is run and applied on small-scale organization, like a Farmer Coop.

The Leadership capital in Sundanese culture, based on Sundanese philosophy, consists of; *Nyantri*, meaning a leader has a strong spiritual capital because the leader used to grow up and live in Islamic Boarding School environment. *Nyakola*, meaning a leader must have ahigh education background and has a wide experience in life. *Nyunda*, meaning a leader must own the sundanese typical characteristic such as low profile, encouraging, able to blend with the society, and willing to listen to his people aspiration. The leadership capital in Javanese culture, based on Javanese philosophy, consists of: Soil means Strong Stance; Fire means Respected; Wind means Low Profile, close to the people, and willing to listen for the aspiration; Water means Calm, Sky means Wise, Moon means Courage, Sun means Spreading Energy, Star means Good Example for the People. *Ingarso Sung Tulodo* (To be the good example), *Ingmadyo Mangun Karso*(To encourage the people), *Tut Wuri Handayani*(To be the motivator).

The interaction between BMT and the farmers is involving dialogic and convergent communication. This communication is using a trusted communication. When a member of the farmer community do an action based on his social motive, then this farmer will receive support and solidarity from the other members of the

farmer community. Farmer as a religious creature, will be doing an action based on spiritual motive, therefore this farmer will run the BMT by obeying sharia law or compliance. Farmer as a BMT customer, is doing his action based on economy motive. These three basics of human nature are the principle for a farmer to get sharia financial support from BMT. When a farmer already receive that syaria financial support, then BMT must giving training and mentoring to the farmer customers who receive the sharia financial support. The training and mentoring topic contain of mental, technical, and management. If the farmer really apply all the three things that taught in the training and mentoring, synchronizedly, then a change might occur within the individual self of that farmer, and this will only happen if the farmer practice a good way to communicating. This practice of interpersonal communication is done through verbal and non-verbal communication, and it is important to stressing it on the competence in communicating. A competence act of communicating will give influence towards social changes, that will further put impact on society's welfare. BMT is targeting suburban area to make that social changes happen, with the intention to balance the national welfare index at its maximum achievement. Nevertheless, the BMT who exist in the rural area is neglected to hold training or mentoring, and resultting the society welfare index result is not maximized.

When a farmer applies a request submission for financial capital to BMT, there is an occuring interaction, communication network, and exchange information between individuals, especially the obvious role of group leader, then naturally farmers will colaborate other party like BMT through social relation and network of information. The information process would be decided by the human capital ability, which in the case of farmer, is the farmer self-concept and their communication competency, to help them later in the future for a decision-making situation to take fund support of syaria financing in BMT. On the concept of human capital taht included the self-concept of a farmer, it views a human as an autonom individual. The ability to communicate and to collaborate are the two competences in individual that potentially will collectively develop the information networks. A high quality of human capital in farming industry will escalate interaction, communication, and collaboration network, which will influence social capital. In the other hand, a strong social capital will enhance human capital, so that both capitals will develop mutual benefit relationships. The social capital in social and economic organization expects collaboration, trust, and obedient towards the applicable rules. The collaboration between individuals in the farmer community should be facilitated by the role of the leader and other institutions in agricultural industry through networks.

The occuring communication process between farmers are the interpersonal communications, which includel dialogical communication, group discussion within the farmer community, infirmation that is being distributed via brochure, social relationship and collaboration. The message that is being deliver by these farmers in a form of *qaulan sadida*, *qaulan baligha*, *qaulan ma'rufa*, *qaulan karima*, *kaulan layinaa* and *qaulan maysura*. Meaning, it is either verbal or non-verbal message shall follow the syaria law that had been written in the Al Quran and Al Hadith, so that the verbal or non-verbal message that is being deliver by the farmer will be understood by

BMT, and that it's communication will touched the heart of the people in BMT. While delivering the message, farmers are using these kinds of media, such as face-to-face, discussing, and *pengajian*.

The social capital acts like glue that will stick everyone in one mutually benefited collaborative network. It will strengthen the relationship between individual, group and institution, and any collaboration to exchange information proves that social capital is part of the relation and network's structure. The relationship between human capital and social capital could be observed through the elements of farmer's self-concept, which shapes the individual personality to work with social capital or to work within its sociological sphere. On the contrary, the social capital elements like to trust each other and norms are also working within its sociological sphere. This proves that between social capital and human capital, they both have a complimentary relationship.

The main information source for a farmer is a fellow farmer, and/or the leader of the farmer community, a next-farm neighbor, a next-door neighbor, a successful farmer, a stall of production tool, a community figure, PINBUK, BMT, Puskopsyah, Agriculture Department, Coop Department, and other sources that is believed to have trusted information for a farmer. The interpersonal communication media is the most dominant media that is being used by a farmer to communicate and in accessing information needed. The local social structure of either Sundanese or Javanese within the ethnic and (Islamic) religious community is still showing that the social capital of kinship and ethnical relation do affect farmer's decision in proposing capital financing to BMT who works under Islamic Sharia Law. A farmer, who accepts himself and maintain positive relationship with other people. He becomes independent, has vision in life, and that he will be able to control the environment, also his personality is developing and changing into an innovative and productive personality. The society also experience some shift towards a social welfare society, where the farmer members of the farmer community are undergoing self-actualization, and there is social coherence and integration within the society. These are the main foundations in attaining social capital.

## CONCLUSION and SUGGESTIONS

The communication process between the farmer and BMT are based on the farmer's self-concept that consists of open-minded, *amanah*/trust, *tabligh*, helping each other, fear of *haram riba*, keep the promise, and healthy body and mind. The intercommunication within the farmer's self is based on his subjective awareness that brings out three kinds of motive to interact with BMT; spiritual motive, economy motive, and social motive. According to a farmer informant in Ciamis, the most dominant motive in this regency is spiritual motive, while in Bantul Regency, the most dominant motive is economy motive. When delivering a message, a farmer tends to deliver it in forms of *qaulan sadida*, *qaulan baligha*, *qaulan ma'rufa*, *qaulan karima*, *qaulan layina dan qaulan maysura*—both through verbal words or non-verbal message that based on sharia principle, which had been written in Al Quran and

Hadith, so that the message will be easily be received and understood by BMT, and the communication will touch the heart of BMT members. Moreover, a farmer will be using face-to-face media, discussion, and Quran recitation media in delivering a certain message.

BMT as a micro sharia financial institution must possess the element of trust. BMT is expected to be trust by the society. This trust is seen through the way BMT is implementing sharia rules on its products and its daily operational. Its procedure for loan financing's contract is suitable for the farmer (the various type of contracts; *mudharabah* and *murabahah*, *Al Qardul Hasan*, etc.), and the service is very pleasant; these factors could be seen through the determination of loan return rates for the farmers. Such condition shows the occurrence of trust communication—a form of communication that assured and reliable for both farmer and BMT. Once the trust communication is achieved, then BMT will start to grant sharia financing to the trusted farmer, in which the product and contract are personalized to each farmer. Additionally, BMT will provide training and mentoring empowerment that contain guidance in mental training, technical training, management training, and marketing training.

Following the empowerment, farmers are expected to adopt the new knowledge that they get from the training and mentoring, while during the process of adopting, the farmers are supposed showing their obedient to sharia law. A farmer who escalates their knowledge, understanding, adopting, and obeying sharia law will achieve welfare in his life. The social capital acts like glue that will stick everyone in one mutually benefited collaborative network. It will strengthen the relationship between individual, group and institution, and any collaboration to exchange information proofs that social capital is part of the relation and network's structure. The relationship between human capital and social capital could be observed through the elements of famer's self-concept, which shapes the individual personality to work with social capital or to work within its sociological sphere. On the contrary, the social capital elements like to trust each other and norms are also working within its sociological sphere. This proves that between social capital and human capital, they both have a complimentary relationship.

The main information source for a farmer is a fellow farmer, and/or the leader of the farmer community, a next-farm neighbor, a next-door neighbor, a successful farmer, a stall of production tool, a community figure, PINBUK, BMT, Puskopsyah, Agriculture Department, Coop Department, and other sources that is believed to have trusted information for a farmer. The interpersonal communication media is the most dominant media that is being used by a farmer to communicate and in accessing information needed. The local social structure of either Sundanese or Javanese within the ethnic and (Islamic) religious community is still showing that the social capital of kinship and ethnical relation do affect farmer's decision in proposing capital financing to BMT who works under Islamic Sharia Law. A farmer, who accepts himself and maintain positive relationship with other people. He becomes independent, has vision in life, and that he will be able to control the environment, also his personality is developing and changing into an innovative and productive personality. The society

also experience some shift towards a social welfare society, where the farmer members of the farmer community are undergoing self-actualization, and there is social coherence and integration within the society. These are the main foundations in attaining social capital.

## REFERENCE:

- Ancok, Djamaludin, 2007, *Membangun Kepercayaan Menuju Indonesia Madani, Demokratis dan Damai*, <http://ancok.staf.ugm.ac.id>, akses tanggal 5 November 2008
- Antonio, M. Sjafei, 2001, *Islamic Banking, Bank Syariah dari Teori ke Praktek*, Gema Insani Press dan Tazkia Cendekia, Jakarta
- Bakir, Vian, 2006, *Policy Agenda Setting and Risk Communication : Greenpeace, Shell, and Issues of Trust*, The Harvard International Journal of Press/Politics, 2006.11.67, <http://hij.sagepub.com/cgi/content/abstract/11/3/67>
- Berger, Peter L. And Thomas Luckmann, 1990, *Tafsir Sosial atas Kenyataan, Risalah tentang Sosiologi pengetahuan*, LP3ES, Jakarta
- Creswell, John W., 2002, *Research Design, Qualitative & Quantitative Approaches*, Alih bahasa : Chryshnanda & Bambang Hastobroto, KIK Press: Jakarta
- Edi S. Ekadjati. 2005. *Studi Pendekatan Sejarah Kebudayaan Sunda*. Jilid 1. Jakarta : PT Dunia Pustaka Jaya. h.7-8,93,168-174
- Freire, Paulo, 2000, *Pendidikan Kaum Tertindas*, LP3ES, Jakarta
- , 1984, *Pendidikan Sebagai Praktek Pembebasan*, Gramedia, Jakarta
- Fukuyama, Francis, 2007, *Trust, Kebajikan Sosial dan Penciptaan Kemakmuran*, Penerbit Qalam, Yogyakarta
- Hafidhuddin, Didin, Mat Syukur, 2008, *Pembiayaan Syariah dalam Pembangunan Pertanian*, Pusat Pembiayaan Pertanian Sekretariat Jenderal Departemen Pertanian, Jakarta
- Hamengku Buwono X, Sri Sultan, 2009, *Pertanian Berbasis Kearifan Lokal*, Disampaikan pada Kuliah umum Lemba Penelitian Universitas Jember, 12 Februari 2009
- Hasbullah J., 2006, *Sosial Kapital : Menuju Keunggulan Budaya Manusia Indonesia*, Jakarta, MR-United Press
- Ieke Sartika Iriany. 2000. Tesis : *Dukungan Lingkungan Sosial Terhadap Aktifitas Peran-Ganda Perempuan Keleas Menengah Etimik Sunda*. Bandung : Pascasarjana : Unpad
- Littlejohn, Stephen W. and Karen A. Foss, 2008, *Theories of Human Communication*, Thomson Wadsworth, Amerika
- Miller, Katherine, 2002, *Communication Theories, Perspective, Process and Contexts*, Amerika, McGraw Hill
- Neuman, W. Lawrence, 2006, *Social Research Methods, Qualitative and Quantitative Approaches*, Sixth Edition, Pearson Education Inc, Amerika
- Nurmanaf, A. Rozany, 2007, *Lembaga Pembiayaan Mikro Lebih Dekat Dengan Petani, Analisis Kebijakan Pertanian*, Volume 5 No. 2, Juni 2007 : 99-109, Bogor
- O'Brien, Jodi dan Peter Kollock, 2001, *The Production of Reality, Essay and Readings on Social Interaction*, Third Edition, Sage Publication : Amerika
- Ritzer, George and Douglas J. Goodman, 2008, *Teori Sosiologi Modern*, Edisi Keenam, Kencana Prenada Media Group, Jakarta
- Scott, James, C, 1981, *Moral Ekonomi Petani, Pergolakan dan Subsistensi di Asia Tenggara*, LP3ES, Jakarta
- Weber, Max, 2007, *Selections in Translation*, Edited By. W.G. Runciman; Translated by Matthews, First Published 1978, 22nd printing 2007, Cambridge University Press, Newyork, e-book
- Wilson, Paul. N., 2000, *Social Capital, Trust and the Agribusiness of Economics*, Journal of Agricultural and Resource Econmis, Western Agricultural Economics Association, Amerika.

## **BIOGRAPHY**

Dr. Suraya, M. Si., M.M was born on November 27, 1968 as the eldest daughter to her parent's five children. Suraya attended SD Negeri II Depok (1976-1981), SMP Negeri II Depok (1981-1984), and SMA Negeri I Depok (1984-1987) in completing her primary education. She enrolled the Jakarta Institute of Social and Political Science (IISIP) in 1987, through Communication Studies Faculty, majoring in Journalistic, with undergraduate thesis on "Comparative Presentation of Buana News' Newspaper Layout Before and After December 1, 1990 Edition in Relation To The Reader Interest in Mariyo-Riyo Agency", and graduated with 3,23 GPA and her Bachelor of Social Science in 1991. She continued her study onto the Graduate program of Communication Studies in the University of Indonesia (UI) in 1997, with thesis on "Ideology Studies on the Aceh Case Coverage within the Discourse of Indonesian Press", and graduated with 3.51 GPA in 1999. She also attended Paramadina Graduate School of Business in 2006 for her second Postgraduate Studies in Islamic Business and Finance program, and graduated in 2010. She earned her Doctoral Degree in Communication Development from Bogor Agricultural Institute (IPB) in 2012.

The Author is currently resides at Komplek Pondok Indah Pancoran Mas (Poin Mas) Blok H2 Nomor 2B, RT02/RW11, Kelurahan Rangkapan Jaya, Kecamatan Pancoran Mas, Kotip Depok, with her husband and her three daughters. She is available to be contacted at (62) 021-77215854 and (62) 08121913353. Since 2002 and up to present day, Suraya has joined the faculty member of Paramadina Graduate School of Communication, and currently take the responsibility as the Head of Paramadina Graduate School of Communication.



## THE REGULATION OF SYARIAH PRINCIPLES IN THE SYARIAH BANKING IN INDONESIA

Mohammad Ghufron Az, [mohammad\\_ghufron@yahoo.com](mailto:mohammad_ghufron@yahoo.com), +6281333647445

### ABSTRACT

This paper results from a research conducted to analyze critically the *syariah* principles within the *syariah* banking law in Indonesia, namely Law No. 21/2008 on *Syariah* Banking. This research is focused on analyzing the law, which prescribes a collateral for *mudharabah* financing and the inconsistencies of norms within laws on *syariah* banking in Indonesia.

This research uses a legal-normative approach. To analyze the existing problems, it uses a theory of “legal systems” (according to Sudikno Mertokusumo and Lawrence M. Friedman), a “theory of *maslahat*” based on Islamic laws, and Jeremy Bentham’s “theory of utility”.

The results show that in the *syariah* banking operation, *mudharabah* financing cannot be implemented purely as its definition based on *syariah* principles. This is because *mudharabah* financing contains high risks. To moderate the risks, adequate collateral is absolutely required as a warranty for settling the repayment of the financing when the *mudharib* is unable to settle his/her debt. On the other hand, collateral in the *mudharabah* financing is definitely required for *maslahah* of public, namely it is intended to secure the depositors. Contradiction in the norms were found because substantively there is different formulations (in prescribing the collateral) between the *fatwa* of National *Syariah* Council (DSN) No. 7/DSN-MUI/IV/2000 on *Mudharabah* Financing (*Qiradh*) and the Article 23 (2) of Law No. 21/2008 on *Syariah* Banking. As a consequence, the interpretation of the Article 19 (point c) is not in line with Article 23 (2). This could result in law uncertainty.

*Keywords: Syariah principles, mudharabah, syariah banking, inconsistency.*

## **1. Introduction**

The majority of Indonesians are Moslems and yet a number of them are still doubtful about the law on bank interest. This doubtfulness has affected their behaviour of not wanting to make a deal with banks. They would only do business with a bank in urgent matters. They prefer to keep their funds at home or in the form of goods or assets, leading to an unproductive accumulation of goods/assets. With such unproductive accumulation of savings, the sources for the financing of development from public sources could not be optimally achieved. Hence the urgent need for banks to run their businesses based on the Islamic syariah principles.

Islamic banking in Indonesia could operate officially only in 1992, following the promulgation of Law Number 7 Year 1992 on Banking and the application of Government Regulation Number 72 Year 1992 on Profit/Production Sharing-based Banking. The permissibility of bank operating based on profit/production sharing basically was an expansion of banking services to meet the demand and desire of the community who preferred compensation/profit not based on bank interest system, but based on profit/production sharing principles outlined under Shari'a. With banks permitted to operate under such profit/production sharing principles, it was expected that the effort to mobilize the entire potential of the community to support national development could be optimized.

With banks permitted to operate under the profit/production sharing principles, Indonesia has applied a dual banking system in the national banking system, namely banks based on interest system (hereinafter referred to as conventional bank) and banks based on the Shari'a principles.

The presence of profit/production sharing-based banks then did not catch optimum attention within the national banking industry, and its journey had not indicated significant progress attributed to the fragile legal basis due to uncertain regulations that could open the opportunity for the operation of shari'a banks. Under Law Number 7 Year 1992 on Banking it was stated that banks applying the shari'a system were only categorized as banks with profit/production sharing and types of businesses allowed thereunder.

In its progress, the term of bank based on profit/production sharing was judicially coined as Shari'a Principle-based Banks.. This was evident under Article 1 number 3 of Law Number 7 Year 1992 on Banking which was amended with Law Number 10 Year 1998 which stated that: Public Bank is a bank operating its business in a conventional manner and/or based on Shari'a Principles which in its

operation delivers services in the interchange of payments. Shari'a Principles meant hereunder was regulations based on the Islamic Law.

The arrangements of Shari'a Banking under Law Number 7 Year 1992 on Banking which was amended with Law Number 10 Year 1998 was viewed as not specifically regulating and accomodating the shari'a banking operational characteristics and required more adequate regulations in line with its characteristics. Based on such urgency, Law Number 21 Year 2008 on Shari'a Banking was promulgated, to provide legal certainty for stakeholders and at the same time the confidence of the community in using shari'a banking products and services.

Such arrangements in reality was that in its operation Shari'a Banking could meet its shari'a compliance and to be able to maintain the existence and principles of Islamic banking. The underlying message in which Shari'a Banking could commit its operation based on Shari'a Principles was outlined under Article 2 Law Number 21 Year 1998 on Shari'a Banking, as follows: "In its operation Shari'a Banking conducts its business based on the Shari'a Principles....". The Shari'a Principles is as referred to under Article 1 Number 12, namely Islamic law principles in banking activities based on fatwa or edict issued by the institution in charge of stipulating fatwa in the shari'a sector. Banking activities based on Shari'a Principles on the other hand, are business activities exclusive of *riba* or usury, *maisir* or gambling, *gharar* or lack of transparency, *haram* or illicit, and *zalim* or unjust. To implement the mandate under Article 1 number 12, the National Shari'a Council of the Indonesian Ulema Board (MUI) issued several *fatwas* as reference for banks in running their businesses.

In line with the progress of Shari'a Bank, some circles doubted the existence of the Shari'a Bank. Some Moslem scholars even criticized that in running their transactions Islamic banks contradicted the concepts. Sutan Remy Sjahdeini, stated that observation and research made by several Moslem scholars indicated that in running their business activities Islamic Banks did not eliminate interest and share risks, but maintained the practice of imposing interests, or in other words avoiding risks in a devious way (1:Sjahdeini, 1999)

This view was not far off judging from the practice of Shari'a Bank thus far. In the contract for *mudharabah* financing (loan and management) for instance, the Bank (*shahib mal*) is not allowed to call for collateral/guarantee from the client (*mudharib*) because this *mudharabah* contract is actually a contract of trust between *shahib mal* and *mudharib*, not a loan in nature but a capital cooperation based on

trust between the bank and client where each party has a share of profit and loss). By asking collateral/guarantee from *mudharib* it means that *sahib mal* no longer trusts the *mudharib*. The consequence of this *shahibul mal's* distrust against *mudharib* makes the *mudharabah* contract void and non-binding.

The demand for collateral in the financing of *mudharabah* by Shari'a Bank in its practice was a deviation which should not have been made. But is is more toward legal obligation that every bank must exercise prudential principle in distributing its funds as regulated under Article 23 Law Number 21 Year 2008 on Shari'a Banking.

The focus of the issue to be discussed in this research is; first, to analyze stipulations under the shari'a banking law which requires collateral in the financing of *mudharabah*. Second, to analyze inconsistencies of norms existing under shari'a banking law in Indonesia. To analyze the issues above, this research uses the normative juridical approach using the "Legal System" according to Sudikno Mertokusumo and from Lawrence M.Friedman, "Benefit" theory according to Islamic Law and "Utility" theory from Jeremy Bentham.

## **2. Research Method**

### **a. Type of Research**

In line with the purpose and objective desired in this research, a legal assessment was exercised conceptualized as positive norms within the nasional legislative system, although such legislation only sets out Shari'a principles. Starting from the above purpose and objective, this research is categorized under the normative legal type. Through this normative legal research, an in-depth study of the shari'a banking statutes will be conducted.

### **b. Approach**

In line with the type of research applied and the issues proposed under this research, to solve or answer the issues proposed, the statutes approach or yuridical method is used meaning research on legal products and in this case legal products associated with Shari'a Banking arrangements.

### **c. Legal/Law Materials**

This research uses three information sources, namely Primary legal material, secondary legal material, and tertiary legal material, as follows:

#### 1) Primary legal material:

Al-Qur'an, Al-Hadits, and laws regulating Banking in Indonesia, particularly shari'a banking.

- 2) Secondary legal materials are legal entities from the analysis of experts available in literary books and scientific articles to be used to assist the analysis and understanding of primary legal/law materials.
- 3) Tertiary legal materials are legal entities which among others are found in law dictionary, encyclopedia or similar materials relevant to this research.

d. **Analysis**

Analysis starts with the grouping of legal entities and the same information based on their aspects and thereafter interpreted to give meanings toward every aspect and relations against each other. This is to be followed by analysis and interpretation of the entire aspect of the main research issue conducted inductively to give a complete picture. Based on the above, the analysis technique used is content analysis, namely analysis based on the content of legal materials. The consideration is that legal materials available are descriptive in nature.

**3. Results and Discussion.**

**a. Mudharabah Principles**

*Mudharabah* is an agreement to participate in taking the advantage of a capital asset from one partner and management expertise from the partner. According to its terminology, *mudharabah* is also called *muqaradhah* or *qiradh*. (2: Algaoud, 2004)

Under the principle of *mudharabah*, share of profit should be stated as ratio or part of the total profit. Profit cannot be stated as percentage of the capital invested. This principle is an important requisite from a legitimate agreement. Any deviation from such principle or from condition coming from uncertainties under this agreement, will make this agreement unimplementable.

According to Muhammad Syafi'i Antonio, *Mudharabah* is business cooperation agreement between two parties, where the first party (*shahibul mal*) provides the whole capital, while the other (*mudharib*) becomes the business manager. Business profit under *mudharabah* is shared based on agreement outlined in the contract. In case of a loss, such loss will be borne by capital owner as long as the loss is not due to the negligence of manager. If such loss is attributed to fraudulence or negligence in part of the manager, the manager will be accountable for such loss. (3: Antonio, 2001)

According to the *fatwa* or edict of the National Shari'a Counsel (DSN) Indonesia Ulama Board Number 07/DSN-MUI/IV/2000 on *Mudharabah*

Financing (*Qiradh*), meant by *mudharabah* financing is financing distributed by Shari'a Finance Institute (LKS) to a certain party for a productive business. Under this financing scheme, the Shari'a Financing Institute (LKS) as *shahibul maal* (capital owner) will finance 100% of the requirement of a (business) project while the business (client) will act as *mudharib* or business manager. The amount of fund must be clearly stated in cash and not as receiveable. As fund provider, LSK will assume all losses *mudharabah* except when *mudharib* (client) commits to a willful misconduct, negligent or violating agreement.

The *fatwa* also states that: "In principle, there is no collateral in th financing of *mudharabah*, but in order for the *mudharib* client) not to violate, LKS may ask for a collateral from *mudharib* or a third party. This collateral/guarantee can only be cashed in if it has been proven that *mudharib* has violated stipulations agreed upon under contract/agreement."

According to the compilation of Shari'a Econmic Law (KHES) Article Pasal 20 (4) the cooperation between fund owner or investor and capital manager is to enter into a certain business with profit sharing based on *nisbah* or ratio.

Under Law Number 21 Year 2008 on Shari'a Banking, *mudharabah* agreement/contract is clarified under Clarification of Article 19 letter c which states that:

"*mudharabah* agreement in financing is a buisness cooperation agreement between the first party (*malik*, *shahibul maal* or shari'a bank) which provides the whole capital and the second party (*'amil*, *mudharib*, or client) which acts as fund manager by sharing profit in accordance with the agreement outlined under contract, while loss will be borne entirely by shari'a bank except when second party commits to a willfull misconduct, negligent or violating agreement".

The *mudharabah* shari'a foundation is depicted the Letter of Al-Muzammil of the Al-Qur'an Surat Al-Muzammil Verse 20, and Letter of Al-Jumuah of the Al-Quran Verse 10 and under the Hadiths.

Al-Muzammil Verse 20 of the Al-Quran:

"... And those who walk on the face of the earth to seek for Allah's bounty....."

Al-Jumuah Verse 10 of the Al-Quran:

"If prayer has been fulfilled, speard onto the earth and seek for Allah's bounty"

Hadith of Muhammad the Prophet:

“The Prophet Muhammad said that there are three things that bear blessings, formidable buying and selling, *muqaradhah (mudharabah)*, and blend wheat and flour for household purposes, not for sale.” (HR. Ibnu Majjah)

In legal terms, *mudharabah* is a business cooperation seeking for profit. This cooperation is entered between capital owner (*shahibul mal*) and business player. It is termed as business cooperation because the capital owner and business player is a partner which directly needs each other.

Capital owner directly needs a business player to run the capital it owns for a business activity to gain profit. On the other hand, a business player having the skill/expertise, opportunity and ability to run a business activity, directly needs capital for the business it runs. This direct mutual interest is what is accommodated *mudharabah*. (4:Siddiqi, 1985)

As a form of cooperation, it is important for *mudharabah* to be understood as basis or foundation of thinking. If *mudharabah* is not clearly understood as a form of cooperation, it may create issue on injustice/unfairness.

The categorizing of *mudharabah* as a form of cooperation starts from islamic economic principle which considers capital and work (business professionalism) not as a distinct factor, but as a mutually benefitting basic unit. Nejatullah said: “*Islam does not regard capital and entrepreneurship as distinct factors with a sparate basis foreward, rather as copartners wih a uniform basis on return*”

Based on this principle, capital has an equal position and on the same level as business professionalism. This same and equal position must be actualized under stipulations regulating rights and obligations between capital owner and business professionalism. If under *mudharabah* agreement there are stipulations contradictory to basic equation between capital and business professionalism creating injustice/unfairness, it can be disputed into a legal suit..

A business player making a loan to a bank cannot be said as cooperation, but rather as lending and borrowing or debt and credit. Lending and borrowing or debt and credit places capital owner and business player in an unequal position, but in an subornative position. The relationship of the two parties is categorized as relationship between creditor and debtor. Therefore, the normative construction established from

such relationship is not a form of cooperation law but of a legal relationship between creditor and debtor. .

The rights and obligations that can be constructed by law against the relationship between creditor and debtor will be different from the rights and obligations in a cooperation. Therefore, the applicable normative stipulations under lending and borrowing or debt and credit relationship cannot be applied in *mudharabah* cooperation relationship.

*Mudharabah* agreement is based on trust between capital owner and business player. A capital owner in search of profit will not give its money as business capital which right to manage is in the hands of business player if mutual trust is not evident. Because under the *mudharabah* agreement or contract the capital owner is not permitted to participate in the management. Business management is in the hands of business player.

Under *mudharabah*, a capital owner can demand certain terms for the capital invested to be effective and efficient. The terms demanded by capital owner can be in the form of compulsion for the capital to be used in certain economic business sector, or terms on the business period or other requirements mutually agreed.

Under *mudharabah* agreement/contract, in addition to terms allowed under such *mudharabah*, the professionalism of business player is an important factor that must be considered under *mudharabah*. A capital owner who do not have the slightest information on the professionalism of business player will carry a big risk against the funds invested. Under the *mudharabah* agreement/contract, a business player must be honest/sincere and possesses integrity as *mudharib* is the representative of *shohibul mal* in running the agreed business, or in other words a *mudharib* must have an *al-amin* attitude or character.

*Mudharabah* cooperation is always based on profit generating, and therefore, profit is the issue and that its method of distribution/sharing must be clearly defined. Legally, *mudharabah* agreement/contract should regulate the issue on profit. If it turns out that the business financed by capital owner suffers a loss, the loss in financial terms, namely the reduced capital must be borne by capital owner. Business player cannot be charged with financial loss because it already bear losses in the form of time, efforts and expertise. Nevertheless, if such loss is attributed to a



mistake, or negligence in its part, then business player should be accountable for the financial loss and capital owner cannot be saddled with such a loss.

## **b. Financing of *Mudharabah* at Shari'a Bank**

### **1) Shari'a Principles in Shari'a Banking Law**

The exclusive and segregated disposition of Shari'a Banking from banking laws is expected to provide legal certainty to stakeholders and confidence to the community in using the shari'a bank products and services. And in the effort to encourage shari'a bank to abide to shari'a statutes in running its business activities, the shari'a banking regulation will also regulate shari'a compliance.

How a shari'a bank can comply with shari'a principles in the financing of *mudharabah* can be seen under Article 1 number 12; Article 2; Clarification of Article 3; Article 19 letter c; Article 23 section (2) and Clarification; Article 24 section (1) a and Section (2) a; Article 26 section (1) and (2); Article 55; Article 56 of Law Number 21 Year 2008 on Shari'a Banking..

Article 12 number 12 of Law Number 21 Year 2008 on Shari'a Banking regulates shari'a principles. Under this stipulation, meant by shari'a principles is the Principles of Islamic Law in banking activities based on *fatwa* or edict released by the institution in charge of decreeing the *fatwa* in the shari'a sector. If the stipulation under this article is associated with Article 26 Section (2), it is obvious that the institution having the authority to release such *fatwa* is the Indonesian Ulema Assembly/Majlis (in this case the executing body is the National Shari'a Council).

Article 2 of Law Number 21 Year 2008 on Shari'a Banking regulates the operational aspects of shari'a banking, which in its clarification it is definitively mentioned that business activities based on shari'a principles are businesses that do not contain the elements of *riba*, *maisir*, *gharar*, *haram* and *zalim*.

Clarification of Article 3 Law Number 21 Year 2008 on Shari'a Banking gives the clarification that in achieving to objective of supporting the implementation of national development, shari'a banking continues to stick to shari'a principles in its entirety (*kaffah*) and consistently

(*istiqamah*). This means that in implementing its activities shari'a bank shall be subject to shari'a principles as mandated by the National Shari'a Council (DSN-MUI). There should be no deviation especially from the substance of such *fatwa* released by DSN-MUI.

Article 19 letter c of Law Number 21 Year 2008 on Shari'a Banking gives the explanation on one of the activities of Shari'a Public Bank, which is to distribute the financing of profit/production sharing based *mudharabah* agreement, *musyarakah* (partnership) agreement, or other agreements which do not contardict the shari'a principles.

Article 23 Section (2) of Law Number 21 Year 2008 on Shari'a Banking and its clarification, in general regulate the feasibility of fund distribution in shari'a bank. Under the stipulation on the feasibility of fund distribution, a shari'a bank must have the confidence to the willingness and capability of financing facility prospective recipient to pay back or return all of its obligations in due time. To come to that confidence, a shari'a bank must exercise a thorough assessment against the character, capability, capital, collateral and business prospects of such prospective financing facility recipient client. Therefore, it can be said that in providing financing a shari'a bank should also make thorough assessment against collateral to be provided by prospective financing recipient client. In other words, in dispensing financing, a shari'a bank requires collateral.

Article 24 of Law Number 21 Year 2008 on Shari'a Banking in general regulates prohibited activities for shari'a banks and Shari'a Business Units (UUS), among others is the prohibition to conduct business activities contradictory against shari'a principles as regulated under Section (1) a and Section (2) a.

Article 26 Section (1) and Section (2) of Law Number 21 Year 2008 on Shari'a Banking is basically a stipulation which emphasizes that all business activities or products and services conducted by shari'a bank are subject to shari'a principles. In addition, it underlines that what is meant by shari'a principles are shari'a pinciples as mandated (*fatwa*-ed) by the National Shari'a Counsil (DSN-MUI).

Article 55 of Law Number 21 Year 2008 on Shari'a Banking regulates settlement of dispute. Settement of dispute in Shari'a Banking is done through the court within the religious affairs court environment. If the disputing parties have agreed to settle their disputes outside the Religious

Court, such as through deliberations, banking mediation, Arbitrary Body, and dispute settlement through the Public Court environment, then such dispute settlement will be made in line with the content of agreement/contract, and the execution must not contradict shari'a principles.

Article 56 of Law Number 21 Year 2008 on Shari'a Banking constitutes sanctions against shari'a bank or UUS, members of the board of commissioners, members of Shari'a Supervisory Board, board of directors, shari'a bank employees for obscuring or not implementing shari'a principles in carrying out their business activities or duties. The sanction is in the form of administrative sanctions stipulated by Bank Indonesia.

From the aforementioned regulations, it is expected that in running its operation a shari'a bank should really comply with shari'a principles, so that shari'a compliance can be manifested as mandated by shari'a banking law.

## **2). Issues in Applying *Mudharabah* Wholly**

Following the understanding of *mudharabah* as proposed by classic Islamic Law experts/scholars as previously mentioned, the application of *mudharabah* in the context of current banking will be faced with various difficulties that makes it impossible to *mudharabah* in all its entirety.

Applying *mudharabah* wholly on simple cases as defined under *musaqah* agreement will not be an issue, such as in agriculture land cultivation profit sharing practice common to the community in Indonesia thus far. In land cultivation cooperation, land owners hand over agricultural land to farmers to be planted with certain crop(s) where the entire financing is borne by land owners under profit sharing agreement between land owners and business player (farmers). In this simple case, the land is still under the control of land owner so that in this case the asset is in secure position. Therefore, in this simple *mudharabah* collateral is not necessary, it is only based on trust. In the case of crop failure, land owner will only bear the loss of capital expenses incurred, while business player will not gain the amount of income as expected.

It will be otherwise if *mudharabah* is applied in the practice of financing in banking. A shari'a bank will face difficulties, among others:

- a. Integrity of business players, related to the bookkeeping of business players which are often not proper and manipulative and thus not in accordance with the real facts.
- b. Sincerity in the use of funds received from the bank. Based on the agreement it should be utilized for productive purposes in line with the proposal submitted, but most often the fund is used for consumptive purposes.
- c. Difficulty for the bank to determine profit margin: bank must gain profit in its operation. In remunerating its profit, the bank will include several components, such as operational cost, overhead cost, inflation and other costs that will influence the extent of margin, and these profits will be charged to the client. As inflation may influence the extent of margin, in determining the extent an assumption is used taking the reference of the analysis of conventional bank interest rate, so that the extent of profit sharing ratio is not different from the interest rate applied in conventional banking. (5:Gafoor, 1995)
- d. Long term financing will bind the capital in an extended time resulting in an extended time of capital return. Capital return within an extended time will be faced with the consequence of uncertainty and high risk. This is quite contrary to credit provided by conventional bank, albeit in long term the capital return will be in line with the start of the initial installment, so that the level of uncertainty and risks is not as high as the uncertainty and risks under *mudharabah* financing.

The extent of risk that must be faced by a shari'a bank in this *mudharabah* financing has resulted in the various innovations in part of shari'a bank in distributing funds through the *mudharabah* financing scheme (6:Hirsanuddin, 2008) in order to reduce the existing financing cost. Among those innovations, the first is by engaging third party to serve as managing body. In this financing scheme, the third party assumes several functions, namely;

- a. Extend supervision to business players receiving financing.
- b. Control and supervision on returning financing received by business players to shari'a bank. .
- c. Management control of business players.

- d. Reporting on business progress from business players to shari'a bank. .
- e. In the event of business failure due to the negligence of business players, the consultant reserves the right and to take over the business management until the financing has been fully paid/returned.

The second innovation is that shari'a bank build partnership with cooperative employees. Employee cooperative was selected as partner under *mudharabah* financing because:

- a. Income of cooperative employees is relatively stable.
- b. Guarantee from cooperative management on the good and honest character of cooperative employees.
- c. The cooperative guarantees repayment of financing if cooperative employees are negligent or ended up in failure in the business financed under the *mudharabah* scheme.

Therefore, in this partnership, employee cooperative acts as guarantor of employees to be receiveing such financing. Employee cooperative also collects payment from cooperative employees and desoposits such payment to shari'a bank. In this partnership, employee cooperative receives management fee from shari'a bank.

From the elaboration above it can be concluded that the practice of *mudharabah* financing in banking is difficult to implement due to several aspects, either from moral, technical, operational cost, and risk factors to be faced by shari'a bank. Therefore, in distributing *mudharabah* financing, shari'a bank perfers to build partnership with cooperatives or use a consultant to serve as managing body for security reasons.

### **3) Collateral Requirements in *Mudharabah* Financing at Shari'a Bank**

As mentioned earlier, the law requires collateral in *mudharabah* financing at shari'a bank. Such collateral will be used to secure return payment from respective shari'a bank when the recipient of financing facility cannot settle its obligation. This is in accordance with stipulation under

Article 23 Section (1) and (2) of Law Number 21 Year 2008 on Shari'a Banking and its Clarification.

In terms of the required collateral under this *mudharabah* financing, in the Bank Mandiri Syariah *mudharabah* agreement/contract there is a clause regulating such collateral which reads as follows:

“To ensure return payment/settlement of Financing in due time and in the amount agreed by both parties under this Agreement, CLIENT hereby declares and binds itself to surrender collateral and establishes a binding guarantee to BANK in accordance with prevailing rules and regulations, which is an inseparable part of this Agreement.”

Likewise, in the agreement for *mudharabah* financing at Bank Muamalat Indonesia there is a clause regulating collateral that reads as follows:

“...As collateral for the fulfillment of client's obligation to Bank and part of profit sharing revenue occurring based on this Agreement, client herewith provides collateral in the form of .....

The clauses mentioned above shows that the *mudharabah* financing requires collateral. In other words, the (*mudharib*) or client has the obligation to provide collateral to guarantee settlement of financing received when the client (*mudharib*) fails to fulfill its obligation to the bank.

Legally, collateral is required in *mudharabah* financing, to provide certainty to capital security invested by bank to the client *mudharib*. On the other side, the requisition of collateral is to protect larger interest namely the interest of other depositors which number is overwhelming.

When confronted with the shari'a principles, such stipulations are contradictory and violate the shari'a principles. In *mudharabah* financing, the bank must comply with the principles found in *mudharabah*.

According to the principles under *mudharabah* agreement, *shahib mal* is not allowed to demand collateral from *mudharib* because this *mudharabah* agreement basically is a mutual trust agreement between *shahib mal* and *mudharib*. On the other hand, *mudharabah* is a joint-capital and expertise cooperation, where the position between capital and business expertise is the same or equal, so that the position of the capital owner and business player is the same or equal.

Hence under such equal position, Islamic Law experts or scholars stipulate the prohibition for capital owner to demand collateral from business player. Because by requiring collateral under such *mudharabah*,

the capital owner places the business player in an unequal position with capital owner. This is clearly a deviation from the philosophy of *mudharabah* itself. (7:Saeed, 1966)

In regard to this collateral, scholars and jurists do not agree with collateral being put *mudharabah* agreement, because basically *mudharabah* is a mutual trust agreement and in the event of a loss both parties should suffer such loss. Therefore, collateral should be eliminated. According to Imam Malik and Imam Syafi'i, if *shahib maal* insisted a collateral from *mudharib* and designates it as part of the contract, then the contract will be invalid. (8:Rusdy) This is also underlined by Latifa Algaoud and Mervyn Lewis, that under *mudharabah*, *shahib mal* cannot demand any collateral whatsoever from *mudharib* to return the capital or capital plus profit, because the relationship between *shahib mal* and *mudharib* is trust and *mudharib* should be a trustworthy person. Under such circumstances, the bank cannot have any guarantee at all from business player as capital security against the possibility *mudharib* suffering a loss. This condition leads to the cancellation and invalidity of *mudharabah*.

In Islam, this collateral issue is not prohibited under the al-Qur'an and Hadith. However, this relates to debts and credits or lending and borrowing, where the position of creditor and debtor is not equal. This inequality is the reason for the permissiveness of collateral under creditor and debtor or lending and borrowing agreement, because the relationship between creditor and debtor is not a cooperation and as such collateral is allowed. (9:Harun, 2000)

Therefore, the demand for collateral by shari'a bank against *mudharib* in *mudharabah* financing is an unavoidable situation because the bank must comply with stipulations regulating prudent principle in the granting of credit or provision of financing facility. On the other hand, DSN-MUI's *fatwa* provides the window for shari'a bank to require collateral in the provision of *mudharabah* financing facility.

Another alternative for requiring collateral that a bank can do to secure financing distributed to the community is by protecting such financing through insurance. Protecting financing distributed to the community through insurance is not impossible. This has been done by shari'a bank in distributing financing, it is just that the implementation is the same as what has been practiced by conventional banks.

#### **4) Inconsistency of *Mudharabah* Principles Regulation under Shari'a Banking Law.**

The regulation of *mudharabah* principles under the shari'a banking law is not consistent. The inconsistency of such regulation is evident from the official reading of Article 3 Law Number 21 Year 2008 on Shari'a Banking which states that "In achieving the objective of supporting national development, shari'a banking continues to uphold shari'a principles in its entirety (*kaffah*) and consistently (*istiqomah*). This clarification mandates that every shari'a banking activity should always uphold the shari'a principles in its entirety and consistently, meaning that there should be no deviation from the sharia'a principles, either substantially or technically.

If the clarification of Article 3 above is associated with the Clarification of Article 19 letter c, where it elaborates the meaning "*Akad Mudharabah*" or "*Mudharabah Agreement/Contract*", which is a business cooperation contract between the first party (*Shahibul mal*/Shari'a Bank) which provide the total capital and the second party (*mudharib*/client) which acts as business manager by distributing business profit in accordance with the agreement set forth in the contract. The loss, if any, will be fully borne by the Shari'a Bank, except when the second party committed a willful misconduct, negligent, or violates the agreement. In principle, the two clarifications should not be an issue because there is a coherency between the two. The clarification of Article 3 underlines the fact that a shari'a bank should comply with the stipulation and shari'a principles in running its business activities, while clarification of Article 19 letter c provides the clarification on the understanding of *mudharabah* contract in line with the understanding provided by shari'a principles.

But when the Clarification of Article 3 and the Clarification of Article 19 letter c are associated with Article 23 Section (2) and its clarification, the inconsistency of the regulation is evident. It can be concluded as such because the norms under Article 23 Section (2) and its clarification is contradictory to what has been defined under Clarification of Article 3 and Clarification of Article 19 letter c.

Article 23 Section (2) of Law Number 21 Year 2008 on Shari'a Banking states:



“To acquire the conviction as referred to under section (1), Shari’a Bank and/or USS is obligated to conduct a thorough assessment against the character, capital capability, Collateral, and business Prospect of prospective Facility Recipient Client.”

Clarification of Article 23 Section (2) of Law Number 21 Year 2008 on Shari’a Banking states that:

“...In assessing Collateral, Sharai’a Bank and/or USS should assess, goods, project of right to claim funded under the respective Financing and other goods, securities or risk guarantee added as Collateral supplement, whether they are adequate and if in the future such Facility Recipient Client cannot fulfill its obligations, such Collateral can be used to shoulder Financing back payment from respective Shari’a Bank and/or USS...”

From the reading of Article 23 Section (2) Law Number 21 Year 2008 it can be concluded that every *mudharabah* contract requires adequate collateral *mudharib* as guarantee when such *mudharib* cannot fulfill its obligations. This means that *mudharabah* contract has gone through a a shift of mean9ng, not the meaning defined under the Islamic Law.

Article 23 Section (2) and its Clarification calls for the existence of guarantee or collateral in the implementation of *mudharabah* contract, while the Clarification of Article 19 letter c provides the understanding of *mudharabah* based on shari’a principles which basically do not require guarantee or collateral, and this clarification is in line with the clarification of Article 3 which mandated that shari’a bank should alway comply with shari’a principles in running its business activities. As such, between Article 23 Section (2) and its Clarification is not consistent with with the Clarification of Article 19 letter c and Clarification of Article 3.

#### **4. Conclusions**

The requirement of collateral in the *mudharabah* financing according to the banking law basically does not contradict the shari’a principles, because collateral is used to anticipate moral hazard *mudharib* or character that emerges, not meant as financial risk as practiced in conventional banking scheme. On the other hand, *mudharabah* is difficult to be applied due to its high risk.

The requirement of collateral under *mudharabah* financing is taken to provide protection to depositors which number is overwhelming. Therefore, collateral requirement is based on a larger interest, namely to manifest public welfare.

The regulations on the principle of mudharabah financing under Law Number 21 Year 2008 on Shari'a Banking, as it turns out, find that there are inconsistent stipulations, that is between the norms found under the Clarification of Article 3 and Clarification of Article 19 letter c with the norms found under the Clarification of Article 23 letter c. Inconsistency in regulations will lead to legal uncertainty and the effort to establish shari'a compliance as mandated under the shari'a banking law difficult to be implemented.

## **5. Recommendations**

The regulations on the principles of mudharabah financing under the shari'a banking law need to be revamped. Revamping is done by revising the formulation of norms under the inconsistent articles. The first is to refine the clarification of Article 19 letter c and the second is to reformulate the clarification of Article 23 section (2) to make them both consistent.

## **REFERENCES**

- (1) Sjahdeini, Sutan Remy, 1999, *Perbankan Islam dan Kedudukannya dalam Tata hukum Perbankan Indonesia*, Pustaka Grafiti, Jakarta
- (2) Algaoud, Latifa M. And Mervyn K. Lewis, 2004, *Perbankan Syariah, Prinsip, Praktik dan Prospek*, Serambi Ilmu Semesta, Jakarta
- (3) Antonio, Muhammad Syafi'i, 2001, *Bank Syariah dari Teori ke Praktik*, Gema Insani, Jakarta.
- (4) Siddiqi, Muhammad Nejatullah, 1985, *Partnership and Profit Sharing in Islamic Law*, The Islamic Foundation, Leicester.
- (5) Gafoor, A.L.M. Abdul, 1995, *Interest Free Commercial Banking*, Apptec Publications, Groningen, Netherlands.
- (6) Hirsanuddin, 2008, *Hukum Perbankan Syariah di Indonesia: Pembiayaan Bisnis dengan Prinsip Kemitraan*, Genta Press, Yogyakarta.
- (7) Saeed, Abdullah, 1996, *Islamic Banking and Interest: Study of Prohibition of Riba and It's Contemporary Interpretation*, E.J. Brill, New York.
- (8) Rusdy, Ibnu, *Bidayatul al-Mujtahid*, Vol.II, Dar al Fikr, Beirut.
- (9) Haroen, Nasrun, 2000, *Fiqh Muamalah*, Gaya Media Pratama, Jakarta.

**Framework of Entrepreneurial Orientation and Competitive  
Advantage:  
(A Study of SMEs Performance in Aceh)**  
<sup>1</sup>Nurdasila Darsono, <sup>2</sup>Nurlina

<sup>1</sup>Doctoral Program of Management Science, Syiah Kuala University, Banda Aceh,  
Indonesia

e-mail: [nurdasila4@gmail.com](mailto:nurdasila4@gmail.com), phone number: 0811687919

<sup>2</sup>Ph.D Student of Management Science, Syiah Kuala University, Banda Aceh, Indonesia

e-mail: [nurlinakisyfa@gmail.com](mailto:nurlinakisyfa@gmail.com), phone number: 085260112115

**Abstract**

This article describes the small businesses in Aceh with the rate of growth and developments, which require a lot of attention. Employers are expected to have a high skill level and to be different in order to have a greater effect on the development of small and medium enterprises in Aceh. Some of the literatures show the importance of entrepreneurial orientation in improving competitive advantage and firm performance. Dimensions of entrepreneurial orientation, namely autonomy, innovativeness, risk-taking, pro-activeness, competitive aggressiveness, contribute to company performance. In this article integrative framework of business performance and the factors that affect the proposed based on the theory of Resources Based View (RBV) as well as several other related theories. The more aggressive in the market players to seize market share which led to small and medium-sized industry sees the need to implement a strategy of innovative products through entrepreneurial orientation so as be able to achieve a competitive advantage in addition to improving the performance of the company.

**Keywords:** *Entrepreneurial Orientation, Competitive Advantage, Firm Performance, Resources Based View, SMEs*

**1.Introduction**

The emergence of competition in the business world is unavoidable. With competition, the company faces a variety of opportunities and threats coming from inside or outside of the country. For that, each company is required to be aware and

understand what is happening in the market and what the consumer desires, as well as changes in the business environment so it will be able to compete with other companies. Rapid changes in today, both in terms of technology, customer requirements and shorter product cycles cause serious problems for businesses including to small and medium enterprises.

In many countries, Small and Medium Size Enterprises (SMEs) is an important sector to spearhead the country's economy. As the backbone of the country's economy, SMEs should be aggressively focusing on improving their productivity, competitiveness and efficiencies (Rusconi, 2008; Weerakkody, 2013). This is because SMEs can generate huge employment opportunities, stimulate competition, enhance quality of human resources, nurture a culture of entrepreneurship, support a large scale industries and open new business opportunities (Weerakkody, 2013).

Nowadays, SMEs are facing an increasingly pressure from the marketplace. Thus, entrepreneurial activities among SMEs have become even more crucial in achieving the firm sustainable competitive advantage ( Wiklund and Shepherd, 2003 ) and they are encouraged to implement an entrepreneurial strategic mindset in order to recognize the threats and capture the opportunities to ensure the firm's will continue to sustain the future ( Krueger, 2000 ).

Indonesian Small and Medium Enterprises ( SMEs ) play an important role in economic development and income growth. Deputy SMEs Assessment Resources Ministry of Cooperatives, in a seminar about Opportunities and Challenges of Indonesian SMEs in the ASEAN Economic Community in 2015 explained that "the growth of SMEs in the period of 2009 to 2013 is 2.3 percent per year. In addition, Micro, small , and medium enterprises in Indonesia have a strategic role. As of late 2012, the number of SMEs in Indonesia 56.53 million units with a contribution to 59.08 percent of Gross Domestic Product. The contribution of SMEs to employment of about 97.16 percent or 107 million people. Some SMEs in Indonesia have the potential to Contribute to international trade as well.

The same fact was also found in Aceh's economy, Micro, Small and Medium Enterprises ( SMEs ) have a strategic role, as applicable in the national economy. According to the Head of Cooperatives and SMEs, the Department of Industry Trade

Cooperatives and SMEs in Aceh, Amir Sjaifuruddin ( 2013 ), the number of SMEs in Aceh reached 55 thousand business units providing employment for 275 thousand people.

The above conditions are reinforced by data from BPS (2010), the overall number of business units of large population (99 %), SMEs only contributes less than 10 % of the total output of the national effort, indicating that there is inequality between the performance and productivity of SMEs with a large-scale effort. The cause of the poor performance and productivity of SMEs, allegedly due to lack of entrepreneurial character and not optimal managerial role in managing the business. Another problem facing employers is the competitiveness of SMEs, namely the competitiveness of SMEs to continue to develop new ideas and creativity, which is generated through the products, processes and their competitiveness over similar products from other provinces.

Consider this case, the sectors of SMEs would need to be developed in the future in relation to the increased role of SMEs. Thus, these sectors will continue to provide an important contribution to employment at the same time increase local revenues.

(Knight, 2000, Dess et al., 1997) suggested that under globalization, SMEs with an entrepreneurial orientation (EO) are more likely to perform better than those that is not such an orientation. According to Knight (2000) with their relatively limited resources and Jack of capabilities, SMEs have to possess EO to survive or even to outperform their competitors in global markets. Globalization requires SMEs to take self-directed actions, to be more innovative, proactive, aggressive, and risk-taking in order to take advantage of opportunities in the marketplace (Zahra and Garvis, 2000).

Entrepreneurial orientation refers to the specific organisational-level behaviour to perform risk-taking, self-directed activities, engaged in innovation and react proactively and aggressively to outperform the competitors in the marketplace (Lumpkin and Dess, 1996). According to Rauch, Wiklund et al. (2009) "EO represents the policies and practices that provide a basis for entrepreneurial decisions and actions". [n other words, EO refers to how the firm acts entrepreneurially. As firm behaviour is the central and

essential element in the entrepreneurial process, it has been the reason why some researchers are interested in investigating EO (Covin and Slevin, 1991).

## **II. Literature Review**

### **2.1 Entrepreneurial Orientation**

Zimmerer, Scarborough, & Wilson (2008) and Makhbul and Hasun (2011) stated that entrepreneur is someone who is able to take opportunities, take risk and develop a new business to gain profit.

Entrepreneurship is known as a new approach to update the firm. The performance would have responded positively by the company began trying to rise from the economic down turn as a result of the prolonged crisis. Entrepreneurship touted as Spearhead (pioneer ) to achieve sustainable economic growth companies and high competitiveness . Weerawerdena (2003 ) explains that the business world is now beginning to embrace new thinking, which is referred to as one of entrepreneurial factors to achieve sustainable economic growth company and highly competitive. Entrepreneurial itself means a human activity with the exertion of mind or body to create or achieve a work that can realize the noble man ( Weerawerdena, 2003)

Entrepreneurial orientation is the key to improve marketing performance. Oriented entrepreneurial companies whose leaders have a clear vision and courage to face the risks so as to create a good performance. Meanwhile Hart (1992, in Nasir and Handoyo, 2003) states that an organization with an entrepreneurial type is associated with low marketing performance. His findings showed that the company managers are entrepreneurs whose performance turns out to be much lower than that of its top managers not entrepreneurs.

Entrepreneurial orientation was introduced by Miller (1983 ) uses the dimensions of innovation, proactive to measure entrepreneurial risk taking. It is claimed that it is necessary to have entrepreneurship orientation to succeed the entrepreneurship in the company. The third dimension has been adopted by subsequent studies ( Covin dan Slevin 1991; Lumpkin and Dess 1996; Lee and Peterson 2000; Kreiser et al 2002; Tarbishy et al 2005).

Lumpkin and Dess (1996 ) summarize and clarify dimension of Entrepreneurial Orientation into five sub- sections, namely autonomy, innovativeness, risktaking, proactiveness, and competitive aggressiveness.

- *Autonomy* is the main dimensions of entrepreneurial orientation. Autonomy independent action of individuals or teams in creating an idea or a vision and bring it to the destination is reached. In general, it means the ability and will be self-directed in pursuit of opportunities.
- *Innovativeness* is an innovation capability and activity related to the perception of the business activities are new and unique. According to Rothwell (1994), one of the definitions of innovation is the introduction of something new, such as ideas, methods, or tools.. Entrepreneurial innovation capabilities is an important point and the essence of the entrepreneur characteristics. Some of entrepreneurship research and literature shows that entrepreneurial orientation showed that more significant entrepreneurial orientation has the ability to innovate than those not having the ability to entrepreneurship (Jaworski, 1993). In other words, entrepreneurship means primary human ( superior ) in generating a job for himself or others.
- **Risk Taking**  
Someone who is willing to take the risk can be defined as a person-oriented opportunities in the context of decision uncertainty. Barriers risks is a key factor that differentiates the company with an entrepreneurial spirit and are not. The main function of high entrepreneurial orientation is how to involve the measurement of risk and risk-taking optimally ( Looy et al. 2003).
- *Proactiveness*  
*Proactiveness* someone for trying to perform is another indication of the application on personal entrepreneurial orientation. Similarly, if a company emphasizes proaktifitas in its business activities, the company has made an entrepreneurial activity that will automatically push the high performance (Weerawardena, 2003).
- **Competitive aggressiveness**

Competitive Aggressiveness, there is a tendency for the company directly and intensely challenging competitors to achieve entry or improve the position, that is, to outperform industry rivals in the market. Competitive aggressiveness characterized by responsiveness, which can take the form of confrontation head-to-head. Competitive aggressiveness also reflects a willingness to rely on unconventional rather relying on traditional competing methods. The other forms of competitive aggressiveness available to newcomers including adopting unconventional tactics to challenge the industry leader (Cooper et al., 1986), analyzing and targeting competitors' weaknesses and focus on high value-added products while carefully monitoring discretionary spending (Woo & Cooper, 1981).

## **2.2 Competitive Advantage**

Competitive advantage has a wide definition range, in this article; the dimensions of competitive advantages were derived from Clark, Hayes, & Wheelwright model. As they suggested that firms compete in the marketplace by virtue of one or more of the following competitive priorities. Time, quality, and cost are, along with flexibility, the basic measurements for assessing all business activities (Clark et al., 1988). Innovation may not be within the original dimensions of Clark, Hayes, & Wheelwright definition, however, innovation is known as a critical factor for firms to create value and sustain competitive advantage in today's highly complex and dynamic environment (Ranjit, 2004).

A firm is said to have achieved a competitive advantage when, through its offering[s], it creates more value for customers in comparison with its competitors. Kaleka (2002) compares competitive advantage to cost advantage and differentiation advantage. Cost advantage is defined as the firm offering its product/service at a lower price. Differentiation advantage, however, represents the customer perceiving a consistent difference in important attributes between a firm's offerings and those of its competitors. As mentioned previously, firms' resources and capabilities are the source of value that create strategy (Barney, 1991).



Competitive advantage has also been hinged on performance that is, a firm experiences competitive advantages when its actions in an industry or market create economic value and when few competing firms are engaging in similar actions (Barney, 2002). Competitive advantage will mean that organisations possess resources and capabilities that are superior to that of its competitors, thus enabling it to deliver superior value to customers (Porter, 2004). Porter's work on competitive advantage had focused mainly cost leadership and differentiation.

The business environment of today and the changes introduced by globalisation were not captured by porter's bases for competitive advantage which invariably, will require some form of advancement. The Boston Consulting Group introduced as supplements to the concept of competitive advantage, six dimensions of advantages which are the bases for new approaches that companies will use in order to compete in the future. They are signal advantage, system advantage, social advantage, simulation advantage, people advantage and adaptive advantage.

### **2.3. Firm Performance**

Performance is defined as ".....the end of activity" or the end result of an activity (Wheelen and Hunger, 2002), Clark argued performance history suggests that marketing performance measures have moved in three consistent directions over the years: first from (1) financial to non-financial output measures: (2) from output to input measures: third, (3) from undimensional to multidimensional measures. Cokins (2004): "Organizations need more nonfinancial measures." To measure firm performance, it is not only using the financial measurement, but also the non financial measurement. In other words, to measure the firm performance, it is not only looking at the profit, but also looking at the marketing as the main source of generating profit.

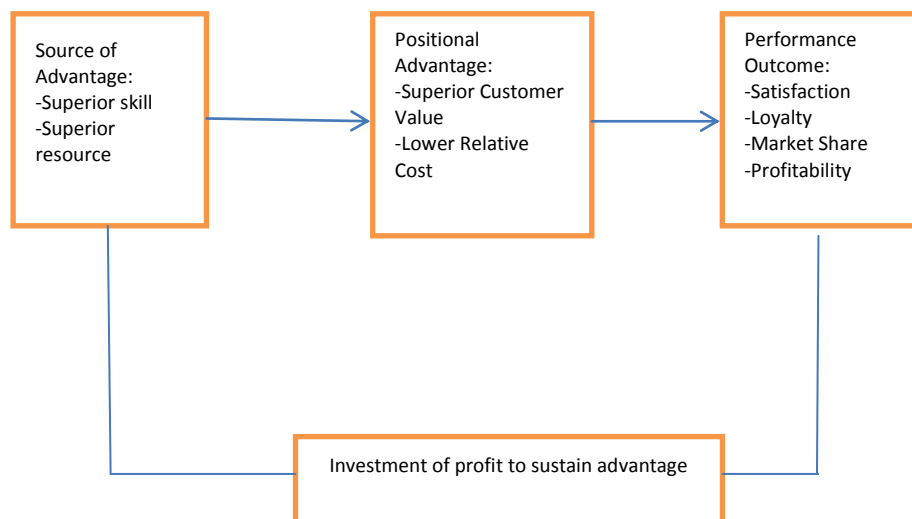
Firm performance is defined in terms of financial performance which comprises of financial efficiency measures such as return on investment and return on equity, and profit measures such as return on sales and net profit margin, profit, turnover or return of investment (Walker and Brown, 2004; Reijonen & Komppula, 2007). Non-financial measures include autonomy, customer satisfaction, sales growth, employee's growth, market share, job satisfaction, the ability to balance work and family (Walker and Brown,

2004). According to (Walker and Brown: 2004), firm performance relates to the firm's success in the market with a different outcomes (Walker and Brown, 2004).

Ma (2007) argue that research have shown a significant relationship between competitive advantage with performance (Ma, 2000; Gimenez and Ventura, 2002; Wang and Lo, 2003; Wiklund and Shepherd, 2003; Morgan et al., 2008; Ray, Barney, and Muhanna, 2004).

The other research by Wang and Lo ( 2003) have found a significant relationship between competitive advantage and sales-based performance in an organiation, where the sales-based performance is measured with revenue, profitability, ROI, productivity, value added products, market share, and product development. Other literatures illustrate there is a significant relationship between competitive advantage and organizational-based performance which is measure by emphasizing the efficiency of organizational internal process, customer satisfaction, staff development, and work satisfaction.

Firm performance is also measured by the firm profitability, market share, and customer value. The competitive element in firm performance (Day and Wensley, 1988), is shown below:



Source : Day and Wensley (1988)

## 2.4 Resources-Based View

Ferreira *et al.* (2007), in their research: “*The Impact of Entrepreneurial Orientation and Resource-Based View on Growth of Small Firm*” examined the influence of SMEs orientation and organization resource to the SMEs performance. The study argue that there is a positive significant relationship between SMEs orientation and SMEs organization resource for a continuous competitive advantage in SMEs development.

The resource-based view of the firm (RBV) draws attention to the firm’s internal environment as a driver for competitive advantage and emphasizes the resources that firms have developed to compete in the environment. Barney (1991) also argued that the resources of a firm are its primary source of competitive advantage. Barney (1991) suggested that other than the general resources of a firm, there are additional resources, such as physical capital resources, human capital resource and organisational capital resources. Later, Barney and Wright (1998) add human resource management-related resources to this list of additional resources of a firm.

These resources can be tangible or intangible (Ray *et al.* 2004). Wernerfelt (1984) also discussed that resources might be tied semi-permanently to the firm. Barney (1991) drew attention to all assets, capabilities, organizational processes, firm attributes, information, knowledge etc., controlled by a firm that enable the firm to conceive of and implement strategies that improve its efficiency and effectiveness’. Ultimately, firms that are able to leverage resources to implement a ‘value creating strategy not simultaneously being implemented by any current or potential competitor’ (Barney 1991) can achieve competitive advantage.

Distinctive competencies refer to all the things that make the business a success in the marketplace (Papp & Luftman 1995). Wang (2004) outlines an approach to firm-level analysis that requires stocktaking of a firm’s internal assets and capabilities. The assets in question could be physical assets, knowledge assets (intellectual capital) as well as human resources, which in turn determine the capabilities of a firm. Maier and Remus (2002) use the term ‘resource strategy’ and define three steps in a firm’s resource strategy - competence creation, competence realisation and competence transaction. Competence creation defines and analyses the markets, product and service. Competence realisation involves the execution of services, procurement, and

production. Competence transaction involves market logistics, order fulfilment and maintenance (Maier & Remus 2002).

Some researchers (Del Canto & Gonzalez 1999; Lockett & Thompson 2001; Ray et al. 2004) distinguished between tangible and intangible resources and conclude that intangible resources are often the most important ones from a strategic point of view. They argue that intangible resources are more likely to be a source of sustained competitive advantage rather than tangible ones. Ray, Barney and Muhanna (2004) understood the difficulties for a firm to change its resources. They suggest that redesigning a firm's processes, activities and routines can enable efficient and effective usage of resources and capabilities that can achieve sustainable competitive advantage.

## **2.5 Conclusion**

Study in SMEs is important. The study result gives contribution to the economic development and growth in a country. The performance and productivity weakness in SMEs is believed to be caused by the weakness of entrepreneurship character as well as the less optimal role of managerial level to run the business. Globalization requires SMEs to form characters such as independent, inovatif, pro-active, agresive, and taking risk to utilize the opportunity in the market (Zahra dan Garvis, 2000). To gain a continuous competitive advantage in SMEs, it requires a strategic mind-set of entrepreneurship in detecting the threats and reaching the opportunities to meet the future expectation of the firm (Kreuger, 2000).

## **Acknowledgement**

We would like to sincerely thank the Syiah Kuala Rector Prof. DR. Ir. Syamsul Rizal, M. Eng, for giving the access of e-journals from library facility, which fully helped us in accessing related references and information. We also would like to sincerely thank the Dean of Economics Faculty, Syiah Kuala University, DR. Mirza Tabrani, MBA, and the Pdh-Program Director of Management Science, Syiah Kuala University Prof. Dr. A.

Rahman Lubis, M.Sc, as well as all the leactures for providing guidance and supports in this study. Also thank for the colleagues who always giving supports for us. And to all related parties in this research, may Allah bless you with mercy and love.

## Reference

Barney, J.B. (1991): Firm Resources and Sustained Competitive Advantage, in: Journal of Management, 17, 1, 99-120.

Barney, Jay. B. (2002), *Gaining and Sustaining Competitive Advantage*, Addison, Wesley.

BCG Analysis, (2009), *The Adaptive Imperative*, Boston, BCG Inc.

Clark, B. H. (1999). Marketing Performance Measures: History and Interrelationships. Journal of Marketing Management, 15, 711–732.

Cokin, Gary, (2004). Performance Management , Finding the Missing Pieces (To Close the Intelegence Gap)

Cooper, A. c., Gimeno-Gascon, F. 1. & Woo, C. Y. (1994) Initial Human and Financial Capital as Pred ictors of New Venture Performance. *Journal ofBusiness Venturing*, 9, 371-395.

Covin, J. G. & Slevin, D. P. (1991) A Conceptual Model of Entrepreneurship As Firm Behavior. *Entrepreneurship TheOIY and Practice*, 16, 7-25.

Day, G. S., and Wensley, R., 1988. Assessing Advantage: A Framework for Diagnosing Competitive Superiority. Journal of Marketing. 52, 1-20.

Del Canto J.G., Gonzalez I.S., (1999), 'A Resource-Based Analysis of the Factors Determining A Firm's R&D Activities', Research Policy, 28, 891-905

Ferreira, A., Moulang, C., and Hendro, B. (2010). Environmental Management Accounting and Innovation: an Exploratory Analysis. *Accounting, Auditing & Accountability Journal*, 23(7), 920–948. doi:10.1108/09513571011080180.

Jaworski, B.J. and Kohli, A.K. (1993), "Market Orientation: Antecedents and Consequences", Journal of Marketing, Vol. 57, July, pp. 53-70.

Kaleka, A. (2002). Resources and Capabilities Driving Competitive Advantage in Export Market: Guidelines for Industrial Exporters. *Industrial Marketing Management*, 31, 273-283

Knight, G. (2000) Entrepreneurship and Marketing Strategy: The SME Under Globalization. *Journal of International Marketing*, 8, 12-32.

Kreiser, P., M., Marino, L., D. & Weaver, K. M. (2002) Assessing the Psychometric Properties of the Entrepreneurial Orientation Scale: A Multi-Country Analysis. *Entrepreneurship The OIY and Practice*, 26, 71-94.

Krueger, NF 2000, The Cognitive Infrastructure Of Opportunity Emergence. *Entrepreneurship Theory and Pract* 24(3):5-23

Lee, S. M. & Peterson, S. J. (2000) Culture, Entrepreneurial Orientation, and Global Competitiveness. *Journal of World Business*, 35,401-416.

Lockett, A& Thompson, S2001, 'The Resource-Based View and Economics' , *Nottingham University Business School Discussion Paper*, Nottingham University Business School, Viewed 25 January2013,

Lumpkin, G. T. & Dess, G. G. (1996) Clarifying the Entrepreneurial Orientation Construct and Linking It to Performance. *Academy of Management. The Academy of Management Review*. 21, 135-172.

Ma, H. (2000): Competitive Advantage and Firm Performance, in: *Competitiveness Review*, 10, 2, 53-64.

Maier, R& Remus, U2002, 'Defining Process-Oriented Knowledge Management Strategies' , *Knowledge and Process Management*, vol. 9, no.2, pp.103-118.

Makhbul, Z. M., and Hasun, F. M. (2011). Entrepreneurial Success : An Exploratory Study among Entrepreneurs. *International Business and Management*, 6(1), 116–125.

Miller, D. (1983) The Correlates of Entrepreneurship in Three Types of Firms. *Management Science rjJre-1986*, 29, 770-790.

Morgan, N.A./Kaleka, A./Katsikeas, C.S. (2004): Antecedents of Export Venture Performance: A theoretical Model and Empirical Assessment, in: *Journal of Marketing*, 68, 1, 90-108.

Morgan A. Neil, Vorhies W.Douglas and Mason H. Charlotte, (2008), Market Orientation, Marketing Capabilities and Firm Performance, *Institutionsof Higher Learning*.

Nasir, Mohamad & Agus Handoyo. (2003). "Effect of Entrepreneurial Orientation To Performance Small Company With Environment and Strategy As Variable Moderate ". *Indonesian Journal of Marketing Science*. Vol.12,p.89-104.

Papp, R& Luftman, J1995, 'Business and IT Strategic Alignment: New Perspectives and Assessments', in *The Association for Information Systems, Inaugural Americas Conference on Information Systems*, Pittsburgh, 25-27August.

Porter, M. E. (2004), *Competitive Advantage: Creating and Sustaining Superior Performance*, USA, the Free Press.

Rauch, A., Wiklund. J., Lumpkin, G. T. & Frese, M. (2009) Entrepreneurial Orientation and Business Performance: An Assesment and Past Research and Suggestions for the Future. *Entrepreneurship Theory and Practice*, 33, 761-787.

Ray, G, Barney, JB, & Muhanna,W, A. (2004). Capabiilities, Business Processes, and Competitive Advantage: Choosing the Dependent Variable In Empirical Tests of The Resource-Based View. *Strategic Management Journal*,25, 23-37.

Reijonen, H., & Komppula, R. (2007). Perception of Success and Its Effect on Small Firm Performance. *Journal of Small Business and Enterprise Development*, 14(4), 689–701. doi:10.1108/14626000710832776.

Rothwell R., Dodgson M., 1994. Innovation and Size of Firm. In. M. Dodgson and R. Rothwell (eds.). *The Handbook of Industrial Innovation*. Edward Elgar, Aldershot: 310-324.

Rusconi, R. (2008). Features And Implications. doi:10.1787/240211858078.

Tarabishy, A Solomon, G Fernald,L & Saghkin, M 2005, The Entrepreneurial Leader's Impact On The Organization's Performance In Dynamics Markets. *Journal of Private Equity*, ( Fall ), 20-29.

Walker, E., and Brown, A. (2004). What Success Factors are Important to Small Business Owners ?, 577–595.

Wang, Y, & Lo, (2003). Customer –Focused Performance and The Dynamic Model for Competence Building and Leveraging: A Resource - Based View.*Journal of Management Development*, 22(6), 483-526.

Wang, HL (2004). 'A framework to support and understand strategic decision-making in businessto-business electronic commerce' , in *The International Workshop on Business and Information (BAI2004)*, Taipei.

Weerakkody, D. (2013). SME as Backbone of economy. Retrieved from [www.sundaytimes.lk/...times/sme-backbone-of-an-economy-34565.html](http://www.sundaytimes.lk/...times/sme-backbone-of-an-economy-34565.html).

Weerawardena, Jay. (2003). "Exploring The Role of Market Learning Capability in Competitive Strategy". *European Journal of Marketing*. Vol.37,p.407-429.

Wernerfert, B.(1984). A Resources Based-View of the Firm. *Strategic Management Journal*, 5, 171-180.

Wiklund J & Shepherd D 2003, Knowledge-Based Resources, Entrepreneurial Orientation, And The Performance Of Small And Medium Size Business. *Strategic Management Journal* 24(13) : 1307- 1314

Zahra, S., A. & Garvis, D., M. (2000) International Corporate Entrepreneurship and Firm Performance: The Moderating Effect of International Environmental Hostility. *Journal O.[Business Venturing*, 15, 469-492.

Zimmerer, T. W., Scarborough, N. M., and Wilson, D. (2008). *Essentials of Entrepreneurship and Small Business Management* (p. 866).



## Factors Influencing Buyers to Purchase Green Residential Property

<sup>1</sup>Thuraiya Mohamad, <sup>2</sup>NoorAileen Ibrahim, <sup>3</sup>Asniza Hamimi Abdul Tharim,

<sup>4</sup>Nur'Ain Ismail, <sup>5</sup>Azurawati Zaidi

<sup>1,3,4</sup>Faculty of Architecture, Planning and Surveying, Universiti Teknologi MARA,  
[thura231@perak.uitm.edu.my](mailto:thura231@perak.uitm.edu.my), [asniz286@perak.uitm.edu.my](mailto:asniz286@perak.uitm.edu.my), [nurai948@perak.uitm.edu.my](mailto:nurai948@perak.uitm.edu.my)

<sup>2,5</sup>Academy of Language Studies, Universiti Teknologi MARA,  
[nooraileen@perak.uitm.edu.my](mailto:nooraileen@perak.uitm.edu.my), [azura9237@perak.uitm.edu.my](mailto:azura9237@perak.uitm.edu.my)

Energy efficiency, conservation of natural resources, carbon-free manufacturing, environmentally friendly materials and alternative energy resources are currently being listed as the main factors that need to be taken into consideration by the development and construction sector in dealing with the greenhouse issue. Developers must now cater to the growing demand for environmentally friendly residences and this can be done by using the green technology application. CB Richard Ellis Research Asia in his report on 'Malaysia Market Prospects Today' stated that awareness on environmental issues will continue due to the demand of green property especially residential properties. However, many debates only focus on energy saving and economic efficiency but not from the perspective of the end user on whether they are comfortable with the building and technology being used. Besides meeting the requirements to develop environmentally friendly buildings, requirements of the house buyers also need to be met. Therefore, the factors that influences buyers in purchasing green residential need to be identified. Thus, a study has been conducted among the residents of Ken Rimba Legian Residences as a case study to determine the factors that influence buyers in purchasing green residential. To achieve the objective, data collection through the questionnaires survey analysis method was used. All the data collected was analyzed using quantitative analysis by using descriptive statistics. The findings indicate that buyers purchase the green residential property due to the factors related to the green residential concept whereby green technology is applied. The most significant factor that potential buyers look for is the landscape design of the development of green residential property followed by the green space area provided at the residential area and the eco-mobility factors.

**Keywords:** *green residential property, resident, green building, purchasing, buyer, green space, development, environment*

### 1. Introduction

To reach the developed country status by 2020, the construction industry is viewed as having a pivotal role in the realisation of this vision. To move towards sustainable construction, more efforts are needed and should be directed towards realising the green agenda of the industry (Zainul Abidin, 2010). In order to achieve this agenda, one of the methods is the implementation of the green building concept. Green building is a concept introduced for better construction development in order to protect mankind and the environment. The green concept implemented in the construction industry is expected to give benefits basically in terms of environmental and social aspects such as cleaner, safer and healthier working environment, reduce damage of the natural environment, minimise waste, and reduce consumption of natural resources, and also for economic benefits such as energy and water savings, improved business opportunities, and also saving through waste minimisation (CIDB, 2013). Nowadays developers use the green technology application. As the report prepared by CB Richard Ellis (CBRE) Research Asia on 'Malaysia Market Prospects Today' stated that awareness on environmental issues will continue to spur the demand for green property especially residential properties. The Green Building Index (GBI) certified for residential category, that has been issued from year to year starting from 2009 from when GBI has been introduced, has been increasing. This shows that green development has been receiving a positive response from the society. Green technology can provide numerous advantages to the society as well as the environment. Green technology refers to the application of the environmental science to conserve the natural environment and resources, and to curb the negative impacts of human involvement (Osman et al., 2012). The green technology applied on the green building concept provides various advantages

which has influenced the buyers to buy the property especially residential property. As the rising demand is expected to continue, the reason why buyers are choosing green residential properties need to be determined in order to meet their requirements in future development of green residences. Therefore, this study was conducted to clarify issues pertaining to green building developments by focusing on identifying the factors that influence the buyers to purchase green residential property. It is hoped that the study will be used by the developers in order to provide the green residential area that meets the buyers' requirements and preferences.

## **2. Literature Review**

### **2.1. Green Building Concept**

Green building is part of the idea created for sustainable construction towards achieving a balanced development by taking into account several factors such as natural surroundings, creating healthy, comfortable and economical place to live, work, and play. For a building to be 'green', overall impact on environment including water, energy and resources efficiency, waste and pollution control, indoor quality, and maintenance from the design stage until construction and building operation need to be in harmony with each other (Abidin, Yusof, & Awang, 2012; CIDB, 2013). By referring to the Green Building Index (2013), green building need to be designed and operated to reduce the impact on the surroundings by focusing on increasing resources use such as energy, water, and materials while reducing the impact on mankind and the environment for the entire building life cycle by having a better siting, design, construction, operation, maintenance, and removal. It is important for the industry to achieve and maintain the high standards quality, health, environment, and safety practice as been mentioned in the Malaysian Construction Industry Master Plan 2006-2015. Towards achieving it, there are several corporations of basic environment management for clean and green practice which include Construction Industry Building Development (CIBD), Malaysian Green Technology Corporation (GreenTech Malaysia), Malaysian Green Building Confederation (MGBC), and Public Works Department (JKR) (CIDB, 2013).

### **2.2 Advantages Of Green Building**

Green buildings are preferred than conventional buildings because the latter consume more natural resources such as energy, water, woods and others as opposed to the former which consume less natural resources. Green building offers several advantages which attract buyers to own this type of buildings.

#### **1. Cost**

Green buildings are often considered as expensive buildings than the conventional type of building without realising that green buildings actually saves at least 10 times more throughout its lifetime usage which will lead to no significant difference in prices between both of the buildings (Redavide, 2013).

#### **2. Energy Efficiency**

There are several ways to use energy efficiently that can be found in green building in terms of operating energy such as using wind power, hydro power, usage of passive solar design and other renewable energy methods (Redavide, 2013)

#### **3. Material Efficiency**

Green building not only focus after the completion of construction but also on material used for the construction. Usage of materials such as non-toxic, reuseable and recyclable materials such as straw, bamboo, recycled metal or stone, compressed earth block and others (Redavide, 2013).

#### **4. Temperature Regulation**

Usually happened in urban area, urban heat islands happen mostly caused by the heat holding properties usually came from toxic materials such as asphalt and concrete of tall building which can be reduced by having more green areas such as green roof and rain garden (Redavide, 2013).

#### **4. Indoor Air Quality**

Without focusing on the type of ventilation system either passive, natural, or mechanical, the green building must have a proper design of ventilation system to ensure that the building have clean air quality. Green building construction give priority to the ventilation system due to the data from US Environmental

Protection Agency which stated that the outdoor air quality can be 2 to 5 times much better than indoor air quality due to poor design of ventilation system (Redavide, 2013).

#### 5. Indoor Environment Quality

The environmental friendly design and material used of green buildings will create a healthier surrounding which are different from conventional buildings. This is to avoid poor indoor environment quality which may cause allergies and other diseases due to several factors such as the carpeting, paints and others (Redavide, 2013).

#### 6. Higher Property Value

Having buildings with sustainable components which will provide the building occupants a low cost of energy and reduced amount of gas, water and energy used will increase the sale value of the building. With net zero building or zero energy home, occupant may not only produce energy but also to resupply the energy into the electrical grid (Redavide, 2013).

#### 7. Tax Benefits

Green building application offers several tax benefits such as Investment Tax Allowance and Stamp Duty Exemption. The Income Tax Allowance (ITA) is basically an allowance given to the owner of the building in order to acquire the GBI Certification. The allowance is given in terms of tax exemption which will be 100% equivalent with amount required for the owner to acquire the GBI Certificate (Green Building Index, 2013). As for the Stamp Duty Exemption will be exempted on the instrument on transfer of ownership for the buildings which the amount are based on the additional cost incurred to obtain the GBI Certificate given only once for the building owner (Green Building Index, 2013).

### **2.3 Factors Influencing Buyers To Purchasing Green Residential.**

The rising understanding and awareness of the public on the environmental issues and impact on the quality of life and human health are generating expectation for green homes (Ismail et al., 2013). Several studies have been conducted to determine the factors that influence buyers to buy the green residential properties. The factors are generally influenced by the advantages provided by the green building concept.

#### 1. Efficiency usage of resources.

Green house must be better than ordinary typical houses as the technology used is expected to reduce energy consumption, indoor cooling, water saving, green material and so forth (Abidin et al., 2012). Ismail et al. (2013) point out one of the criteria of green homes required by house buyers is efficient usage of resources. This criteria included the energy efficiency, water efficiency, and material efficiency. Omer (2008) stated that 40% of total world annual energy consumption are caused by buildings which came from lighting, cooling, heating, and air conditioning and the only way to reduce it is by designing the building with economical use of energy. Energy efficiency help to reduce a lot of development cost in the construction industry (Ismail et al., 2013). Green building theory include lowering environment load, increasing energy efficiency and saving resources throughout the whole life cycle of the building (Xia, Zhu, & Lin, 2008). Water is important in daily lives. With the scarcity and rising cost, the allocation and usage of water need to be more efficient through various ways such as minimising wastage, efficient allocation, incentive provision for development of technology, and reusing or recycling water enforcement can be used (Ismail et al., 2013).

#### 2. Lower operating cost.

According to Ismail et al. (2013), the green home most important element is the aspect of saving during construction and after construction by using resources efficiently without wastage. Satterfield (2009) argued that green building may require higher price to buy but will save money over the life of the building through lower operating cost. Redavide (2013) mentioned that 20% investment on green building has 10 times more saving throughout its lifetime.

#### 3. Safe and healthier environment.

Safety and protection is one of the criteria required by house buyers of green homes due to awareness of living in a secured zone. Levy and Lee (2004) stated that the influence of family members on housing purchase decisions that parents will usually prefer criteria that suit the needs of their children such as proximity to schools, size of yard and safe environment for their family members. Brasington and Hite (2005) conclude that high income, high education level and people with children preferred more environmental quality.

4. Lower impact on environment.

According to Alias et al. (2010), green building construction method applied to reduce impact, the amount of water used released to the environment can be reduced through recycling up to 30% - 40% annually. The demand for green development is rising as the environmental awareness among Malaysians increased because they believe that green building not only saves energy and money but they also can reduce the effects of climate change and its effects on mankind and environment (Aliagha, Hashim, Sanni, & Ali, 2013).

5. Access to green space.

Jim and Chen (2007) indicated that green spaces and water bodies play important role to enhance local amenities, landscape, and recreational opportunities in urban area and demonstrate that home buyers would pay for environmental externalities.

6. Eco-mobility.

Development of housing scheme is not adequate without transportation system. House buyers has the desire for transportation for the purpose of overcoming distance from house to the workplace, shop, hospital, school, business, visit friends and relatives (Walsh et al., 2006). This is another factor contributing to the choices buyers made before purchasing green buiding residential homes.

7. Community design and planning.

The main reason why people in developed countries adopt the features of green homes is due to the arrangement of housing community which include fulfilling human needs, ensuring perfection and safety, to market convenience in the future which are represented by public infrastructure, community design, design for safety, and adaptable building (Ismail et al., 2013)

8. Landscape.

Abidin et al. (2012) indicated that the respondent which is developers agreed that one of the selling point of housing property is landscape which can increase the beauty of project and also promote the green project. Apart from that, Maruani and Amit-Cohen (2013) mentioned that there are many studies carried around the world which prove that landscape attributes have effects on development projects, with people willing to pay for properties with open landscape or landscape element at even higher price.

### **3. Research Methodology**

#### **3.1. Data Collection**

This study applies the case study approach in order to gauge the factors influencing buyers in purchasing green building residential properties. According to Zainal (2007), the case study approach allows the researcher to examine data needed for a specific context or area. This approach also provides a method of selecting a small geographical area or a limited number of individuals as the subject for a study. Hence, the case study approach refers to a study done in a selected area or group of respondents by means of gathering and examining all information required to fulfil the study objectives. In this study, in-depth analysis was conducted on the green residential residents of Ken Rimba Legian Residences involving structured questionnaires to conduct perception survey. Questionnaire forms were distributed to residents of this green residential housing scheme to obtain their perceptions on factors influencing them in purchasing green residential properties. The questionnaire survey was done on a face-to-face approach with the respondents to enable the researcher to explain the research objectives and guide them in answering the questionnaires.

A set of 120 questionnaires was distributed to the residents of Ken Rimba Legian Residences, Shah Alam in order to determine the factors that influence them in purchasing green residential property and a total of 100 feedback questionnaires are appropriate to be used for this study purpose. All the data collected were analyzed using quantitative analysis by using descriptive statistic. The data were analyzed using Statistical Package for Social Science (SPSS) software. The finding from this study clearly shows that buyers purchase the green residential property due to the factors that exist in the green residential concept which is green technology. The main factor is the landscape design of the development of green

residential property followed by the green space area provided at the residential area and the eco-mobility factors. It shows that people are currently looking for a residential area with certain features that provide better living environment which include green space area with good landscape design, and adequate transportation system. It is hoped that the study will be used by the developers in order to provide the green residential area that meets their requirements and preferences.

### **3.2. Sampling Methods**

The choice of respondents for the study involves selection using the purposive sampling technique that refers to the sampling procedure whereby a group of subjects is selected from a specific population to be the study respondents. A group of these subjects is selected based on certain characteristics to represent the entire population being studied (Marican, 2005). As the study carried out is related to the green residential properties, the respondents will be selected because they are green residential buyers. For this purpose of the study, the sample size is determined according to the total units of houses in the Ken Rimba Legian Residences. The total units of houses at Ken Rimba Legian Residences are 328 units. However, in order to meet the objectives of the study which is to determine factors that influence buyers in purchasing green residential property, only 160 units of the houses are selected to be in the sample size because the other half of the house are currently unoccupied and also being let out to tenants. According to Robert V. Krejcie (1970), based on the total number of houses which is 160 units, the total sample which can be used are 113 samples. And for this purpose of study, 120 questionnaires were distributed to the respondents. There were only 100 completed return questionnaires out of 120 questionnaires distributed (88%); highlighting the importance of questionnaire response analysis in demonstrating the valid number of returned questionnaires for systematic analysis.

### **3.3. Data Analysis**

In analyzing and evaluating the results of this study, quantitative approaches were used involving data and information analyzed through perception survey method. Quantitative data obtained through structural questions involving Likert scale type questions contained in structured questionnaire forms were analyzed by using the Statistical Package for the Social Sciences (SPSS) software. The data was analyzed using descriptive statistics involving frequency distribution and percentages which are presented in the form of tables. Neuman (1994) proposed that descriptive statistics provides a method to reduce large matrix data into suitable summaries. The purpose is to facilitate the understanding and interpretation of the data later tabulated into percentages and frequency distribution forms for univariate analysis.

## **4. Findings and Discussion**

Findings from this empirical study revealed that there are five (5) factors contributing to the residents' choice to live in GACOS concept housing areas. Summaries of the descriptive analyses by frequency, percentage and mean score for every factor are shown in Table 1.

**Table 1:** Mean Score for gated and guarded community selection factors are shown in Table 1.

Factors	(frequency and percentage)					Mean Score
	Strongly Disagreed	Disagreed	Moderately Agreed	Agreed	Strongly Agreed	
Landscape Design	0	0	1 (1%)	56 (56%)	43 (43%)	4.42
Access to Green Space	0	0	7 (7%)	52 (52%)	41 (41%)	4.34
Eco-Mobility (Adequate transportation system)	0	0	2 (2%)	64 (64%)	34 (35%)	4.30
Safe and Healthier Environment	0	0	8 (8%)	62 (62%)	30 (30%)	4.22
Efficiency Usage of Resources (Water, energy, material efficiency)	0	0	18 (18%)	60 (60%)	22 (22%)	4.04
Low Operating Cost of Maintenance	0	0	8 (8%)	84 (46.7%)	8 (18%)	4.00
Reduce Impact on Climate Change and Effect on Man and Environment	0	0	18 (18%)	66 (66%)	16 (16%)	3.98
Convenient Arrangement of Community Design and Planning	0	0	19 (19%)	78 (78%)	3 (3%)	3.84

[Source: Researchers' Study, 2015]

The main factor influencing buyers in purchasing green residential properties is landscape design with a mean score of 4.42. This indicates that 43% strongly agree and 56% agree that this housing concept is important. The results shown are similar to the study carried out by Abidin et al. (2012) that the main factor that influence buyers to purchase residential property is the landscape design. It is supported with the statement by Maruani and Amit-Cohen (2013) that many studies have proven that people are willing to pay for properties with landscape element even with a high price.

The second factor is access to green space with a mean score of 4.34 (52%, (n=52) of the respondents agreed and 41 (n=41) respondents strongly agreed that access to green space as the factor that influence respondents to purchase green residential property. The analysed result shows that the respondents have agreed with the study done by Jim and Chen (2006) that green space play an important role in influencing buyers to purchase green homes.

Eco-Mobility with adequate transportation system makes up the third ranked factor with a mean score of 4.30. As shown in Table 1, a total of 98% (n=98) respondents agreed with the factors eco-mobility that influence the respondents to purchase green residential property and only 2%(n=2) of the respondents moderately agreed with eco-mobility factors. The result shows the same result as what was stated by Walsh et al. (2006) that house buyers look for a good transportation system in their residential area.

The factors such as safe and healthier environment are one of the factors that influence respondents in purchasing the green residential property which is ranked forth at mean score 4.22. The majority of respondents i.e 30% (n=30) strongly agree and 60% (N=60) agree that safe and healthier environment offered by green residential development influence them to purchase the green residential property. It shows that the studies done by Levy and Lee (2004) and Brasington and Hite (2005) that safe and healthier environment quality offered are factors that influence buyers in purchasing green residential property.

The choice of this housing concept is due to the efficiency usage of resources which is ranked fifth at mean score 4.02. Majority of the respondents agreed with the efficiency usage of resources as the factor that influenced the respondents to purchase the green residential property with a total of 60% agreed and 22% strongly agreed. The data analysed shows that most of respondents also agreed with Ismail et al. (2013) regarding the criteria required by housebuyers on green homes which are efficiency usage of resources.

With mean score 4.00, low operating cost of maintenance is one of the factors that influenced the respondents to purchase green residential property with n=88 respondents agreed and n=8 respondents strongly agreed. This result supports the findings by Satterfield (2009) and Redavide (2013) that green homes provide up to 10 times saving throughout the lifetime of the building on operating cost is agreed by the respondents.

Finally, reduce impact on climate change and effect on man and environment as well as convenient arrangement of community design and planning community ties are the lowest ranked factor at mean score 3.98 and 3.84 respectively. It is nevertheless still an important factor in influencing the respondents to buy green residential property.

## **5. Conclusion**

In conclusion, even though the green building concept is gradually being accepted in most of the states in Malaysia, the results analyzed from the survey shows that people are aware of the advantages offered by the green residential property and are buying the property due to the advantageous features offered by the green building concept that helps conserve nature. The landscape design factor was chosen most probably because currently most people like to live in an environment that is visually stimulating which may offer a comfortable environment with a nice view of landscape. The factor that is ranked the second important is access to green space area. At present, the modern society is faced with the dilemma of scarcity of land or space and living in a concrete jungle. Due to this, green space area is one of the factors that contribute to the decision of choosing green residential building. While another important factor is the eco-mobility factors. It shows that adequate transportation system and good accessibility were the main factors considered by house buyers. Therefore, the analyzed results show that the factors that influenced buyers in purchasing green residential property are related to the provision of green space area with good landscape design. It shows that people are looking towards the green features offered by the green building concept in order to have a better living environment. Green property development leads to positive effects for nature and the environment. The application of green technology may reduce the effects of pollution towards earth. Since the green building concept has been introduced, it is important to ensure that the implementation of the green building concept receives positive feedback from users. It is hoped the further studies be conducted on green residential property in the future to give benefits and better result to all parties involved.

## **6. Further Research**

In completing this study, there were still gaps in the study which may be subjected to future research such as an investigation on different case studies. The study carried out is only on one case study which is Ken Rimba Legiance Residences. However, the results of the study may be different if the case study is being done on several residential areas which may result in different perceptions towards factors that influence the buyers in purchasing green residential property. In order to determine whether other residential buyers also share the same opinion as the residents at Ken Rimba Legiance Residences, further studies on several places is recommended. This study has identified factors influencing the buyers to purchase the residential property. Therefore, further research may also be carried out in the future to gauge the level of satisfaction of the green building residents or buyers in relation to these factors. The area covered in any further research may also be widened to include other regions and states in Malaysia.

## References

- Abidin, N. Z., Yusof, N., & Awang, H. (2012). *A Foresight into Green Housing Industry in Malaysia*. Paper presented at the Proceedings of World Academy of Science, Engineering and Technology.
- Aliagha, G. U., Hashim, M., Sanni, A. O., & Ali, K. N. (2013). Review of Green Building Demand Factors for Malaysia. *Journal of Energy Technologies and Policy*, 3(11), 471-478.
- Alias, A. A., Sin, T., & Aziz, W. (2010). The Green Home Concept—Acceptability and Development Problems. *Journal of Building Performance*, 1(1).
- BERNAMA. (2012). CIDB Promotes "Greentech" in Construction Industry. from <http://www.iproperty.com.my/news/5000/cidb-promotes-greentech-in-construction-industry>
- Berry, S., Whaley, D., Davidson, K., & Saman, W. (2014). Near zero energy homes—What do users think? *Energy Policy*.
- Brasington, D. M., & Hite, D. (2005). Demand for environmental quality: a spatial hedonic analysis. *Regional Science and Urban Economics*, 35(1), 57-82.
- Chan, E. H., Qian, Q. K., & Lam, P. T. (2009). The market for green building in developed Asian cities—the perspectives of building designers. *Energy Policy*, 37(8), 3061-3070.
- Chau, C.-K., Tse, M., & Chung, K. (2010). A choice experiment to estimate the effect of green experience on preferences and willingness-to-pay for green building attributes. *Building and Environment*, 45(11), 2553-2561.
- CIBD, C. I. D. B. (2013). *Planning and Implementing Green Practices for Building Construction Works*. Kuala Lumpur.
- Creswell, J. W., & Miller, D. L. (2000). Determining validity in qualitative inquiry. *Theory into practice*, 39(3), 124-130.
- George, D., & Mallery, M. (2003). *Using SPSS for Windows step by step: a simple guide and reference*. Boston, MA: Allyn y Bacon.[Links].
- Green Building Index. (2013). Green Building Index Home. from <http://www.greenbuildingindex.org/>
- GreenTechnology.Org. (2010). Green Technology. from <http://www.green-technology.org/what.htm>
- Ismail, R., Shafiei, M. W. M., Said, I., & Ibrahim, F. A. (2013). Green Homes Development Practices and House Buyers' Requirements: A Review. *Australian Journal of Basic and Applied Sciences*, 7(13), 7-15.
- Jim CY, Chen WY. (2006). Perception and attitude of residents towards urban green spaces in Guangzhou (China). *Environmental Management* 2006; 38 (3): 338–349.
- Khoo, D. (2010). Demand for green buildings in Malaysia to rise, says property consultancy. from <http://www.theedgeproperty.com/news-a-views/1534>
- Kim, M. J., Oh, M. W., & Kim, J. T. (2013). A method for evaluating the performance of green buildings with a focus on user experience. *Energy and buildings*, 66, 203-210.
- Levy, D. S., & Lee, C. K.-C. (2004). The influence of family members on housing purchase decisions. *Journal of Property Investment & Finance*, 22(4), 320-338.
- Marican, S. (2005). *Kaedah Penyelidikan Sains Sosial*. Selangor: Pretice Hall Pearson Malaysia Sdn. Bhd.
- Maruani, T., & Amit-Cohen, I. (2013). Marketing landscapes: The use of landscape values in advertisements of development projects. *Landscape and Urban Planning*, 114, 92-101.
- Neuman, W.L. (1994). *Social Research Methods: Qualitative and Quantitative Approaches*. United State of America: Pearson
- Omer, A. M. (2008). Energy, environment and sustainable development. *Renewable and Sustainable Energy Reviews*, 12(9), 2265-2300.
- Osman, W. N., Udin, Z. M., & Salleh, D. (2012). *Green technologies and their application in Malaysian construction industry*. Paper presented at the 3rd International Conference Technology and Operations Management, Bandung, Indonesia.
- Redavide, F. (2013). Advantages and Disadvantages of Green Building. from <http://www.castaliahomes.com/blog/advantages-disadvantages-green-building/>
- Robert V. Krejcie , D. W. M. (1970). Educational and Phychological Measurement - Determining Sample Size for Research Activities. 30, 607-610.



- Satterfield, Z. (2009). Green Building. Retrieved 4, 8, from  
[http://www.nesc.wvu.edu/pdf/dw/publications/ontap/2009\\_tg/greenbuilding\\_DWFSOM129.pdf](http://www.nesc.wvu.edu/pdf/dw/publications/ontap/2009_tg/greenbuilding_DWFSOM129.pdf)
- The Edge Malaysia. (2009). Malaysia's Green Building Index launch on May 21. from  
<http://www.theedgemaalaysia.com/property/14241-new-malaysias-green-building-index.html>
- Walsh, E., Babakina, O., Pennock, A., Shi, H., Chi, Y., Wang, T., & Graedel, T. (2006). Quantitative guidelines for urban sustainability. *Technology in society*, 28(1), 45-61.
- Xia, C., Zhu, Y., & Lin, B. (2008). Renewable energy utilization evaluation method in green buildings. *Renewable Energy*, 33(5), 883-886.
- Zainul Abidin, N. (2010). Investigating the awareness and application of sustainable construction concept by Malaysian developers. *Habitat International*, 34(4), 421-426.
- Yin, Robert K., (2003). *Application of Case Study Research*. 2<sup>nd</sup> Edition. CA: Sage Publications

# ANALYZING SUSTAINABILITY OF SMES IN AUTOMOTIVE COMPONENT INDUSTRY IN BEKASI REGENCY

<sup>1</sup>Medyana Juniarty, <sup>2</sup>Yunita Ismail

<sup>1</sup>President University, [medy\\_juniarti@yahoo.co.id](mailto:medy_juniarti@yahoo.co.id), 0852 9929 5651

<sup>2</sup>Management, President University, [yunitaismail@president.ac.id](mailto:yunitaismail@president.ac.id), 0816 482 9817

## Abstract.

This research aims to analyze the sustainability of SMEs in the automotive component industry. Specifically, it has two main objectives: finding the relationship between sustainability and each variable, and finding the current sustainability pattern of SMEs in the automotive component industry. The topic is addressed due to the nature of the industry (material and waste) where sustainability is undeniable. Supported by the growing number of SMEs in the industry, where the effect of collective SMEs can be as big as a corporation. The results of this study help to understand the current sustainability practices and as input for companies in the industry. This research was specifically conducted in Bekasi Regency and used the YDBA definition for SME. There are six variables used to analyze sustainability practices in the industry: energy consumption, water consumption, waste management, environment preservation, equality in society, and noise and emission management. This research was conducted quantitatively by conducting a survey in 30 companies. The results were then analyzed using multiple regression analysis (standard and stepwise) to test the hypothesis. The results of the research found that the current sustainability practices of SMEs in the automotive component industry have a positive significant relationship with water consumption, waste management, and noise and emission management; a negative un-significant relationship with energy consumption; and a positive un-significant relationship with environment preservation and equality in society. The second analysis using stepwise shows that there are three necessary variables that contribute to the current sustainability: water consumption, waste management, and noise and emission management.

**Keywords:** *Automotive Component Industry, Bekasi, SME, Sustainability.*

## 1. Introduction

Indonesia's automotive component industry, both for cars and motorcycles, is one of the industry's that is growing rapidly, has high value and is most promising in Indonesia (USAID & SENADA, 2007). This industry is dominated by small and medium enterprises (SME) that produce non-brand and hyper-price sensitive products, as a result of consumer demand for various product quality and price. In the automotive component industry, most of the raw materials used are categorized as non-renewable resources (iron, steel, aluminum, silver, copper, etc.). While the major environmental wastes generated by the automotive manufacturing industry include: machine lubricants and coolants; aqueous and solvent cleaning systems; paint; and scrap metals and plastics (Kulkarni, Rao, & Patil, 2014).

Based on the nature of activities in the production process, the sustainability issue in the automotive component industry is inevitable. Sustainability is a large over-arching direction that shapes the business world for a decade or more, also called as a mega trend (Kohl & Resource Associates Corporation, 2011). A survey by Ernst & Young in cooperation with Greenbiz Group in late 2011 that covered a wide range of topics related to corporate sustainability and reporting, shows that the interest in sustainability continues to rise, although the tools are still developing.

From the critical point of view, it is sure that this concept cannot be ignored by companies, which want to be successful in the future (Zavodna, 2011). The customer and shareholder as part of society are becoming more and more conscious toward the sustainability issue, that also influences their purchasing decision. At the end, it will impact the company's profitability and financial market. Sustainability in a company also could become a competitive advantage. It is supported by Montiel (2008) who stated that among academics, sustainability is a widely accepted concept and the key variable to achieve competitive advantage.

A study by Wilkinson, Hill, and Gollan (2001) revealed that top management support, human resource management, employee empowerment, teamwork and reward systems have been important factors for achieving sustainability, on the one hand (as cited in Kontic & Kontic, 2012, p. 537-538). Due to

this condition sustainability is a term that should be integrated into all parts of the companies in every industry in every country, including automotive component industry in Indonesia.

As stated before, the tools in measuring the sustainability are still developing and the latest research by Zavodna (2013) try to measure sustainability by using Balanced Scorecard (BSC). Zavodna suggest six goals that become the target of sustainability that is measured by using BSC, they are: lowering energy consumption, lowering water consumption, waste reduction, environment preservation, equality in society, and lowering noise and emissions.

However, using BSC to measure the sustainability can be used only to measure sustainability in one specific company. It is because the sustainability requires organizational change and adaptation on different levels (Linnenluecke & Griffiths, 2010). The sustainability goals in BSC from one to another company might be different.

The sustainability is becoming more and more important not only for the big enterprises, but also in SME. It is because the effect of unsustainable practice of collective SMEs can be as big as the large corporations, and this growing amount of SME happen in the automotive component company. It is supported by World Business Council for Sustainable Development (2004) that stated that collectively SMEs have considerable environmental impact.

On the other side, SME does not have any sustainability report or even tools to measure the sustainability. This condition makes the knowledge about the current sustainability of the SME in the automotive component industry becoming important.

Since the sustainability practice is varies from one company to another, using BSC to measure the current sustainability of an industry is becoming not applicable. However, the suggested six goals could become the variable to measure the current sustainability practice across the industry.

Based on the explanation above, , the objective of present research are:

1. To determine the relationship between sustainability and company activity in energy consumption, water consumption, waste management, environment preservation, equality in society, and noise and emission management.
2. To determine the current pattern or the fit model of sustainability in the industry.

As an empirical study, the present research has several limitations that may be improved by the future researcher. The limitation of this research is the result of time and financial consideration. The main limitation is the industry, present research only conducted in the automotive component industry. The future research might be discussing the other industry since sustainability is applicable for all of industry.

Based on the company size, this research limited to SME, based on the YDBA definition. The SME definition based on YDBA, only applicable for automotive and automotive component industry, therefore might not be applied effectively for other industry. The present research address SME in general without considering the further sub-classification of SME.

Based on the location, this research only conducted in Bekasi Regency. The future research might be conducted in the broader or other areas in Indonesia. The sustainability is only measured based on the six variables, they are energy consumption, water consumption, waste management, environment preservation, equality in society, and noise and emission management. The questions for each activity in the questionnaire developed based on the SME activity and might not be applied effectively in the company with the smaller or bigger amount of the asset.

## **2 Theoretical Review**

### **Sustainability and Sustainable Development**

The word sustainable was first introduce in a report published in 1972 called “The limits to growth” (Attah, 2010). The writers of the report “Limits of growth” described “sustainable”: We are searching for a model output that represents a world system that is sustainable without sudden and uncontrollable collapse and capable of satisfying the basic material requirements of its entire people” (Meadows et al, 1972).

Sustainability and sustainable development is two interrelated word that sometime used interchangeably. A good way of distinguishing between the two is this quote: “sustainable development is the pathway to sustainability” (Circular Ecology, 2014).

The definition of sustainability development was introduced by the World Commission on Environment and Development in 1987. It stated that sustainable development is development that meets the needs of the present without compromising the ability of future generations to meet their own needs. This is due to the belief that the amount of resources is limited, while the amount of population who consume those resources is keep growing.

After the introduction of the term by World Commission on Environment and Development, there has been a development of three spheres (essential aspects) of sustainability development which discussed by Holmberg, Reed, and Harris et al. (as cited in Harris, 2003).

1. **Environmental:** An environmentally sustainable system must maintain a stable resource base, avoiding over-exploitation of renewable resource systems or environmental sink functions, and depleting non-renewable resources only to the extent that investment is made in adequate substitutes. This includes maintenance of biodiversity, atmospheric stability, and other ecosystem functions not ordinarily classed as economic resources.
2. **Social:** A socially sustainable system must achieve fairness in distribution and opportunity, adequate provision of social services including health and education, gender equity, and political accountability and participation.
3. **Economic:** An economically sustainable system must be able to produce goods and services on a continuing basis, to maintain manageable levels of government and external debt, and to avoid extreme sectorial imbalances which damage agricultural or industrial production.



**Figure 1. The Three Spheres of Sustainability**

Source: Adapted from Sustainability Assessment and Reporting for the University of Michigan's Ann Arbor Campus (2002)

The discussion of sustainability was rapidly developed due to its importance. The importance of sustainability was explained by Rodriguez, Roman, Sturhahn, and Terry (2002), they are:

1. Sustainability can be seen as a necessity in order to avoid the costs of deteriorating social, environmental, and economic systems.
2. Sustainability can be seen as a source of new opportunities to improve the rate and extent of human development.

Along with the population grow that demand more resources, the industrial activities also grew around the world. These increased industrial activities over the years did not consider the resulting environmental degradation such as water, air and land pollution (Attah, 2010). The sustainability is a word that address this phenomena.

In the extensive discussion of sustainability, various entities started to define their role and responsibilities to create the sustainable world, and one of them is the corporation. In addition to adopting policies and undertaking actions to improve their sustainability, corporations are also developing tools for monitoring, assessing, and reporting their environmental and sustainability performance (Rodriguez, Roman, Sturhahn, & Terry, 2002).

As the issue becoming more and more important, especially for the environment, ISO develop ISO 14000 that address various aspect of environmental management, ISO 26000 that provides guidance on how businesses and organizations can operate in a socially responsible way, ISO 14001 that address management system standard, and ISO 9001 for quality management.

The next issue to address is the tools to measure the sustainability in the business. There are various approach introduce to measure sustainability in a company, one of them is introduced by Zavodna.

Lucie Sara Zavodna (2013) introduce balance scorecard with a set of suggested variables used to measure the sustainability in the business. Using the suggested variables of Zavodna, the following list of indicators then use in this research:

**Table 1. The Variables and Indicator of Research**

<b>Variable</b>	<b>Definition</b>	<b>Indicators</b>
<b>Energy Consumption</b>	Energy consumption in this research not only refers to the amount of energy that consume by the company, but also what energy that is consumed (renewable or un-renewable), and the consideration of choosing the energy.	<ol style="list-style-type: none"> <li>1. Energy consumption from renewable resources</li> <li>2. Lowering Consumption of energy (year)</li> <li>3. Average consumption of Vehicle Fuel</li> </ol>
<b>Water Consumption</b>	Water consumption in this research refers to the expenditure of water that has been supplied to satisfy the needs of the company for non-production activities. It also refers to the activity to improve the effectiveness of water consumption	<ol style="list-style-type: none"> <li>1. Average consumption of drinkable water</li> <li>2. Average consumption of Hot Water</li> <li>3. Management of Waste Water</li> </ol>
<b>Waste Management</b>	Waste management in this research refers to the collection, removal, processing, and disposal of materials that considered waste. It also refers to the activity to reduce the amount of waste produced.	<ol style="list-style-type: none"> <li>1. Number of Waste Containers</li> <li>2. Percentage of Recycled Waste</li> <li>3. Percentage of Assorted Waste: paper, plastic, glass, bio-waste</li> <li>4. Average disposal cost</li> </ol>
<b>Environment Preservation</b>	Environment preservation in this research refers to the activities to maintain the present condition of company surround condition that has not been distorted.	<ol style="list-style-type: none"> <li>1. Investments for the savings of nature / environment</li> <li>2. Percentage of costs going back to the environmental protection</li> <li>3. Percentage of office supplies recycled</li> </ol>
<b>Equality in Society</b>	Equality in society refers to the company's ability to provide equal treatment to all of members of society. Specifically, in this research, it refers to concern on local employee, gender diversity, local resources, and attention to the employee health and safety.	<ol style="list-style-type: none"> <li>1. Percentage of local employees</li> <li>2. Percentage of woman in management</li> <li>3. Percentage of material from local resources</li> <li>4. Percentage of certified suppliers</li> <li>5. Number of safety improvement projects</li> </ol>
<b>Noise and Emissions Management</b>	Noise and emission management in this research refers to company's concern and ability to manage and minimize the noise and emission produced	<ol style="list-style-type: none"> <li>1. Air emission</li> <li>2. Greenhouse gas emission</li> <li>3. Average work week hours</li> <li>4. Average overtime work hours</li> </ol>
<b>Sustainability</b>	Sustainability in this research refers to the ability of the company to conduct their activities by maintaining a stable natural resources for the present and the future, providing fair distribution and opportunity for society, and maintaining the continuity of the company activity to produce goods and services.	<ol style="list-style-type: none"> <li>1. Energy consumption</li> <li>2. Water consumption</li> <li>3. Waste management</li> <li>4. Environment Preservation</li> <li>5. Equality in society</li> <li>6. Noise and emissions management</li> </ol>

Source: Zavodna (2013)

In this research, automotive component industry using as an sample to saw the sustainability practice. The automotive industry in Indonesia have high growth and the positive impact in contributing to the total GDP and society, but it also creates negative impact.

Automotive component industry has a negative impact on environmental issues, especially environmental pollution caused by industrial waste and utilization of natural resources is not efficient

(Dewayana, Sugiarto, & Hetharia, 2013). This industry created both pollution and waste as the result of its production activities. In addition, the raw material used by the automotive component industry in the form of a mixture of steel and steel (with different compositions), aluminum, silver, copper, materials for molds, rubber processing and rubber, foam, and paper for the manufacture of filters. (Dewayana, Sugiarto, & Hetharia, 2013). All of these materials are the un-renewable resources that has finite amount.

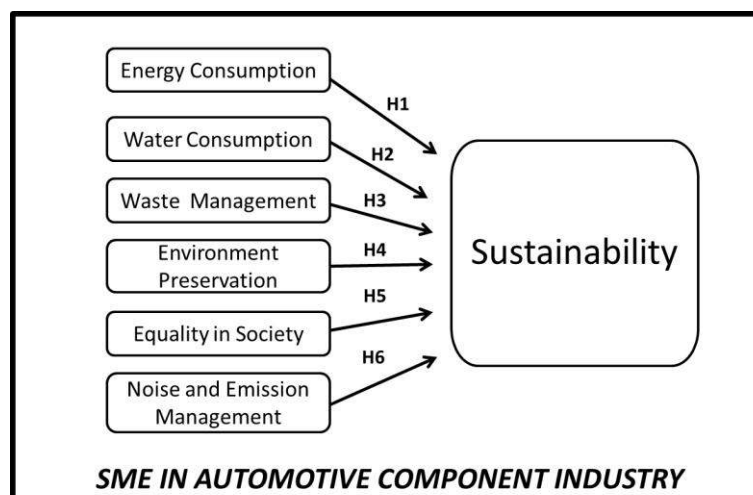
Based on the impact that created toward environment and the automotive component industry is being pointed out as one of the major cause of global air pollution which resulted in climate change, smog, greenhouse gases (GHGs), and human diseases by many reasons (Shatouri, 2012). Therefore, it is important for the automotive component industry to minimize the environmental impact created by its production and preserve the environment.

The automotive component industry consist of Small and Medium Enterprise (SME) and in this research definition of SME based on the Yayasan Dharma Bhakti Astra (YDBA) classification. This classification is considered more applicable in the automotive component industry, due to the high asset value on machinery required in this industry.

The small enterprise is the company that own asset with total amount less than 5 billion rupiah (< 5 billion rupiah) and medium enterprise is the company that own asset with total amount between 5 billion rupiah to less than 50 billion rupiah ( $\geq 5$  billion rupiah – < 50 billion rupiah) (YDBA, 2014).

### Theoretical Framework

To create more understanding toward the research, the conceptual framework is developed. It is shown in Figure below, there are six independent variables and one dependent variable to answer the problem statement proposed in the previous chapter. There will be six hypotheses in this framework, measuring the relationship of each independent variable (predictors) with the dependent variable (criterion variable), that will answer the first problem statement.



**Figure 2. Research Conceptual Framework**

Based on Figure 2. there are six hypotheses in this research. After conduct the literature review, a number of hypotheses can be constructed, they are:

- Hypothesis 1:** There is positive significant relationship between energy consumption and sustainability
- Hypothesis 2:** There is positive significant relationship between water consumption and sustainability
- Hypothesis 3:** There is positive significant relationship between waste management and sustainability
- Hypothesis 4:** There is positive significant relationship between environment preservation and sustainability
- Hypothesis 5:** There is positive significant relationship between equality in society and sustainability
- Hypothesis 6:** There is positive significant relationship between noise and emission management, and sustainability

## Research Method

The present research is an empirical study that designed based on the quantitative approach, where statistical analysis will be used to prove the hypotheses in the previous chapter. The analysis of the present research used both descriptive and inferential statistic. The population of this research is the SME in automotive component industry that located in Bekasi Regency. The population choose based on the consideration that Bekasi is one of the center of Industrial in Indonesia, where majority of automotive component cluster located.

The sampling size in this research is 30 companies. The amount is represent the result of this research since it already fulfill the requirement for the big sample. The sampling technique is non-probability sampling that is purposive sampling. Purposive sampling is a form of non-probability sampling in which decisions concerning the individuals to be included in the sample are taken by the researcher, based upon a variety of criteria which may include specialist knowledge of the research issue, or capacity and willingness to participate in the research (Oliver, 2006). In this research, the criterias is the company (a legal entity) in automotive component industry categorized as SME based on YDBA definition, and located in Bekasi Regency.

Since this research use mathematically based methods, variables that are not represented in quantitative data should be converted to be numerical form. The researcher use likert scale to convert the variables into quantitative data. The questionnaires developed using scale 1 to 5, where each of the scale has these following meaning:

**Table 2. The Meaning of Likert Scale**

Scale	Meaning
<b>1</b>	You are allow to choose <b>number 1</b> when <b>your company never do and do not have plan (for the next one year) to do the activity</b> that mentioned in the statement.
<b>2</b>	You are allow to choose <b>number 2</b> , when <b>your company never do, but have plan (for the next one year) to do the activity</b> that mentioned in the statement.
<b>3</b>	You are allow to choose <b>number 3</b> , when <b>you do not sure whether your company ever or never do the activity</b> that mentioned in the statement.
<b>4</b>	You are allow to choose <b>number 4</b> , when <b>your company ever do</b> the mentioned activities in the statement, <b>but do not have plan to re-do or do not held</b> the activity <b>continuously</b> .
<b>5</b>	You are allow to choose <b>number 5</b> , when <b>your company ever do</b> the mentioned activities in the statement <b>and plan to re-do or held</b> the activity <b>continuously</b> .

The questionnaire that construct in this research composed of the suggested six areas by Zavodna (2013). However, not all of indicators suggested by Zavodna used in this research, several indicators is not used or replace by the other indicators. All questions in questionnaire have been tested the validity and reliability.

After get the valid and reliable questionnaire, primary data were collected through several ways They are questionnaire that directly delivered to the company, questionnaire that send by email, questionnaire that available as the online survey, and the phone interview to ask the questionnaire feedback.

The hypothesis testing will be done by using two method of multiple linear regression, they are standard (enter) and fit-model (stepwise). Multiple regression analysis is a statistical technique that is powerful and flexible to develop a mathematical relationship between a metric dependent variable and two or more independent variables (Malhotra, 2010). It is used to analyze the relationship between independent variable and dependent variable. If the result shows that the relationship exist, means the information that we had in independent variables can improving the accuracy to predict the value of dependent variable.

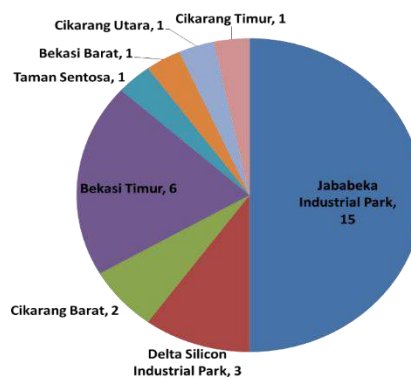
There are two method of multiple regression analysis used in this research, they are standard (method enter) and fit-model (method stepwise). The first method that is method enter is used to answer the first problem statement. By using this method, we will be able to know the relationship of each independent variables with the dependent variable, all of independent variable enter at a time. While the second method is stepwise, it is used to answer the second problem statement, that is finding the

fit model of the current sustainability practice. This method do not enter the variable at the time, but it result on several models of independent variable combination, and one of them is the fit-model. The multiple regression will run after the data fulfilled the assumption. These are normality, multicollinearity and heteroscedasticity. Testing the hypothesis using f test dan t test.

## Result and Analysis

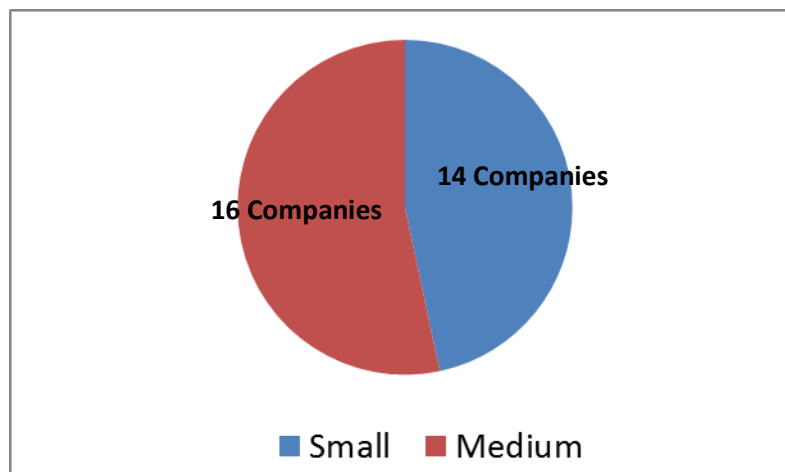
### Respondent Profile

The result of respondent profile generated from the questions in the questionnaire is summarize in these two pie charts below. The first pie chart shows the respondent profile based on the location and the second is the pie chart that shows the proportion of small enterprises compared to the medium enterprises that involve as the respondent in this research



**Figure 3. The Respondent Based on Location**

In this research, the majority respondent are located in Jababeka Industrial Park, which is fifteen companies. Then there are three companies located in Delta Silicon Industrial at Lippo Cikarang. The rest companies spread in both Bekasi (seven companies) and Cikarang (five companies), not located in the industrial area.



**Figure 4. The Respondent Based Company Size**

The pie chart above shows that there are ratio of 53:47 toward the proportion of Medium Size Enterprises toward Small Size Enterprises. The amount of small enterprises is 14 companies, while the amount of medium enterprises is 16 companies.

The validity of the data gathered analyze by using Pearson Correlation in SPSS. This is to determine the relationship and significance of each question and the variable. The validity achieve when the r compute value is equal or greater than the r-table value. In this case, r is Pearson Product Moment coefficient. In this research the r-table value is 0.306, as the result of  $df = N-2$  ( $30-2=28$ ) with 0.05 level of significance in one-tailed test. All questions in questionnaire are valid . The reliability test in this research conducted by using Cronbach's Alpha in SPSS. Seeing the cronbach's coefficient alpha



in the table below, which is 0.899, it indicates satisfactory internal consistency reliability. The standard used in this research is 0.6 (Malhotra, 2010).

## Descriptive Statistic

### 1. Energy Consumption

**Table 3. Mean of Each Statement in Energy Consumption**

Code	Statement	Mean
EC1	This company has policy to use the renewable energy (i.e. solar energy) as the source of energy.	1.40
EC2	This company concern on and keep trying to minimize the amount of energy consumption year by year.	3.17
EC3	This company considers sustainability factors in determining the energy to use. Example: Prefer to use solar energy rather than fuel, since it is more environmental friendly.	1.30
Mean of the whole Energy Consumption		1.96

Variable energy consumption in this research is formed by three different statement. The statement that has biggest average responds is EC2 "This company concern on and keep trying to minimize the amount of energy". The amount 3.17 means that the average of the responds relay between scale number 3 that is "do not sure" or scale number 4 that is "have do the activity and do not have plan to re-do or not happen continuously". While the average responds toward statement EC1 and EC3 relay between scale 1 and 2. Looking at the statement as a group or as one variable called Energy Consumption, the average responds is 1.96, that relay between scale 1 and 2. Scale 1 means "never do the activity and do not have plan", while scale 2 means "never do the activity but have a plan to do it".

### 2. Water Consumption

**Table 4. Mean of Each Statement in Water Consumption**

Code	Statement	Mean
WC1	This company highly concern on the hazardous waste water disposal in order to make sure the freshwater supply is not polluted.	2.03
WC2	This company re-use the waste water from non-production activities. Example: Waste water from wudhu re-use to water the plant.	1.33
WC3	This company concern on and keep trying to minimize the amount of water consumption year by year. Example: hang a poster about effectiveness of water consumption	3.37
Mean of the whole Water Consumption		2.24

Variable water consumption in this research is formed by three different statement. The statement that has the biggest average respond is statement WC3, that is relay between scale number 3 that means do not sure about the activity and 4 that means they have do the activity but do not plan to re-do or do not happen continuously. While looking at these three statements as a group called water consumption, the average responds is 2.24, that relay between scale number 2 (never do, have a plan) and scale number 3 (do not sure).

### 3. Waste Management

Variable waste management in this research is formed by four different statements. Looking at the contribution of average or mean of respond from each statement, the biggest average respond is from WM1, relay between scale number 3 that means do not and scale number 4 that means they ever do

the activity and do not plan to re-do or not happen continuously. While the rest tree statement relay between scale number 2 and 3. It also happen when we look at these statements as a group called waste managemnt, the average respond relay between scale number 2 and 3.

**Table 5. Mean of Each Statement in Waste Management**

Code	Statement	Mean
WM1	This company concern on and keep trying to minimize the amount of waste production year by year.	3.33
WM2	This company recycle or re-use the solid waste from production activity to keep the surround environment.	2.30
WM3	This company sort the waste from non-production activity (i.e. paper, plastic, glass) before dispose the waste.	2.67
WM4	This company concern on and keep trying to improve the waste processing, so that it becomes more environmental friendly.	2.53
Mean of the whole Waste Management		2.71

#### 4. Environment Preservation

Environment preservation as the variable operationalized by three different variables. The result shows that the gap between average respond of each statement contribution gap is not far different. The statement with the highest average respond is EP2, "This company allocate fund through Corporate Social Responsibility to empower the local / surround society". The lowest average of responds or means in this variable own by EP3, that relay between scale 1 and 2. Looking at these statements as a group called Environment Preservation, the average of responds is 2.14, relay between scale number 2 and number 3.

**Table 6. Mean of Each Statement in Environment Preservation**

Code	Statement	Mean
EP1	This company allocate fund through Corporate Social Responsibility to preserve the surround environment.	2.13
EP2	This company allocate fund through Corporate Social Responsibility to empower the local / surround society.	2.43
EP3	This company put an effort to recycle the office supplies.	1.87
Mean of the whole Environment Preservation		2.14

#### 5. Equality in Society

**Table 7. Mean of Each Statement in Equality in Society**

Code	Statement	Mean
ES1	This company employ the local people (people who stay around the company).	4.80
ES2	This company paying attention to gender diversity in the middle and top level management.	4.17
ES3	This company prioritize local resources to fulfill the non-production needs. Example: Catering provided by local catering around the company location.	4.27
ES4	This company concern on and keep trying to improve Occupational Health and Safety.	4.63
Mean of the whole Equality in Society		4.47

The equality in society variable that represent by four different statements shows that all of the statement almost have similar amount of average responds or mean. All the statement relay between scale number 4 that means they have do the activity but do not re-do or continuously and 5 that means they have do the activity and re-do or continuously. Looking at these statements as a group called equality in society, it also shows the similar results, the amount of average responds or mean is 4.47, relay between scale 4 and scale 5.

## 6. Noise and Emission Management

**Table 8. Mean of Each Statement in Noise and Emission Management**

Code	Statement	Mean
NEM1	In choosing the technology, this company consider and prefer to the technology that produce less noise and emission.	3.97
NEM2	This company put an effort to prevent the increasing of average temperature, since it is an urgent issue and impacted the company activities	3.53
NEM3	This company highly consider additional working hour because it can increase the amount of noise and emission produced.	3.33
Mean of the whole Noise and Emission Management		3.61

The noise and emission management variable that represent by three different statements also shows that each statement almost contribute the similar average responds or mean to the result of the research. The highest number is 3.97 from statement NEM1, "In choosing the technology, this company consider and prefer to the technology that produce less noise and emission", then followed by NEM2 and NEM3. All of the average responds relay between scale number 3 that means do not sure and scale number 4 that means have do the activity but do not re-do or not continuously. The result is also similar the amoment we look at the statements as a group called Noise and Emission Management.

## 7. Sustainability

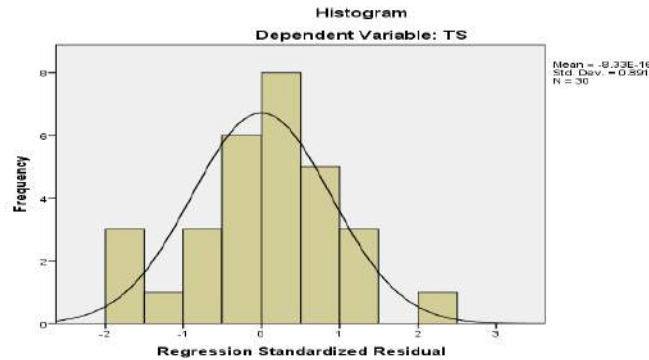
Sustainability as dependent variable represent by six different statements, each statement represent the independent variable. The highest average respond is coming from S5, as much as 4.27 meas relay between scale number 4 and 5. While the lowest average responds or mean coming from the S1, "This company practicing sustainability by keep trying and concern on energy consumption" that is 1.90. While looking at these statement as a group called sustainability, the average means is realy between scale number 2 and scale number 3.

**Table 9. Mean of Each Statement in Sustainability**

Code	Statement	Mean
S1	This company practicing sustainability by keep trying and concern on energy consumption.	1.90
S2	This company practicing sustainability by keep trying and concern on water consumption.	2.10
S3	This company practicing sustainability by keep trying and concern on waste management.	3.03
S4	This company practicing sustainability by keep trying and concern on environment preservation.	2.27
S5	This company practicing sustainability by keep trying and concern on equality in society.	4.27
S6	This company practicing sustainability by keep trying and concern on noise and emission management.	3.47
Mean of the whole Sustainability		2,84

### Multiple Regression Assumptions

Multiple regression assumptions is a parametric statistic, means the data has several requirements that needs to be fulfilled by using normality test, multicollinearity test, and heteroscedasticity test.



**Figure 5. Normality Test**

The histogram above shows that the normality test result in bell-shaped pattern, which means that the data gathered is normally distributed. Ideal multiple model should be normally distributed (Ghozali, 2009).

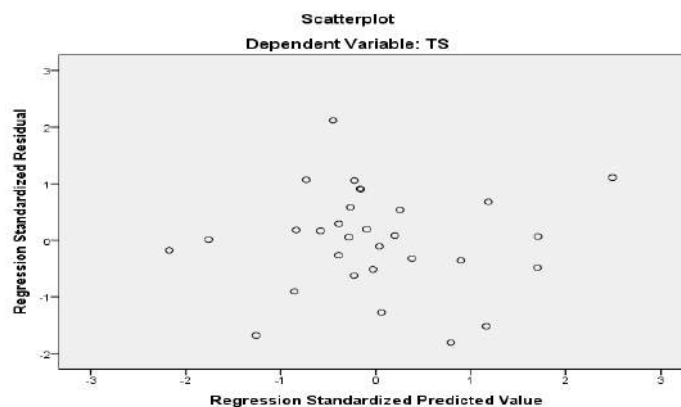
**Table 10. Independent Variable Collinearity**

Model		Collinearity Statistics	
		Tolerance	VIF
1	(Constant)		
	EC	.581	1.722
	WC	.470	2.128
	WM	.586	1.707
	EP	.683	1.464
	ES	.723	1.382
	NE	.775	1.291

a. Dependent Variable: TS

The next test that is need to be done is multicollinearity test. This test examine whether there is high correlation between independent variables in multiple regression model. This correlation shows by VIF (Variance Inflation Factor). When the number of VIF is less than 10, it means that collinearity is not affecting the regression coefficients. VIF shows how much the variance of estimated regression coefficient increases if the explanatory variables are correlated. Looking at the table above, the second requirement of using multiple regression analysis is passed.

The last test is heteroscedasticity test, that is showed by the scatter diagram above that is not make any pattern. It means there is no any heteroscedasticity between variables.



**Figure 6. Heteroscedasticity Test**

### The Standard Multiple Regression Analysis

The standard multiple regression analysis conducted in this research using energy consumption, water consumption, waste management, environment preservation, equality in society, noise and emission management as predictors (independent variable) and sustainability as the criterion variable (dependent variable).

The multiple regression model showed by this following equation:

$$Y = \beta_0 + \beta_1 X_1 + \beta_2 X_2 + \beta_3 X_3 + \beta_4 X_4 + \beta_5 X_5 + \beta_6 X_6 + \varepsilon$$

When the model integrated with the variable in this research, the multiple regression model will be:

$$S = \beta_0 + \beta_1 EC + \beta_2 WC + \beta_3 WM + \beta_4 EP + \beta_5 ES + \beta_6 NEM + \varepsilon$$

Where:

Y = S = Dependent Variable → Sustainability

$\beta_0$  = Y Intercept

$\beta_1 - \beta_6$  = Regression Coefficient

X<sub>1</sub> = EC = Independent Variable 1 → Energy Consumption

X<sub>2</sub> = WC = Independent Variable 2 → Water Consumption

X<sub>3</sub> = WM = Independent Variable 3 → Waste Management

X<sub>4</sub> = EP = Independent Variable 4 → Environment Preservation

X<sub>5</sub> = ES = Independent Variable 5 → Equality in Society

X<sub>6</sub> = NEM = Independent Variable 6 → Noise and Emission Management

$\varepsilon$  = Random Error

**Table 11. Model Summary**

Model	R	R Square	Adjusted R Square	Std. Error of the Estimate	Durbin-Watson
1	.930 <sup>a</sup>	.865	.830	1.775789	2.089

a. Predictors: (Constant), TNE, TEC, TWM, TES, TEP, TWC

b. Dependent Variable: TS

The amount of Adjusted R Square in the table above indicate the amount of variance in the dependent variable that independent variable or predictors account for when the whole predictors taken in a group. The table above shows that a set of predictors (energy consumption, water consumption, waste management, environment preservation, equality in society, noise and emission management), account for 83% of variance in sustainability.

The ANOVA table used to know whether this R square significantly greater than zero. In this research, significant will achieve if p value (Sig.) ≤ 0.005. Based on the table above, Predictors are able to account for significant amount of variance. So when we take 6 predictors as a group (assume that there is no any relation in between the independent variable), they predict sustainability significantly.

**Tabel 12. ANOVA**

Model		Sum of Squares	Df	Mean Square	F	Sig.
1	Regression	466.438	6	77.740	24.652	.000 <sup>b</sup>
	Residual	72.529	23	3.153		
	Total	538.967	29			

a. Dependent Variable: TSxxxxc

b. Predictors: (Constant), NE, EC, WM, ES, EP, WC

After looking at the significant of predictors as a group, the significance of each predictors then examine. The result is show in the table above. The significance level achieve when p-value < 0.05. Based on the Table 13, three predictors are significant, they are water consumption, waste management, and noise and emission management. Then water consumption, waste management, and noise and emission management show positive relationship and explain significance amount of variance in sustainability. The rest three variables energy consumption, environment preservation and equality in society are not significant. This result supported Hypothesis 2, Hypothesis 3, and Hypothesis 6. And not supported Hypothesis 1, Hypothesis 4, and Hypothesis 5.

**Table 13. Coefficients**

Model		Unstandardized Coefficients		Standardized Coefficients	T	Sig.
		B	Std. Error	Beta		
1	(Constant)	2.471	2.184		1.131	.270
	EC	-.474	.236	-.202	-2.009	.056
	WC	.834	.178	.523	4.687	.000
	WM	.307	.113	.273	2.729	.012
	EP	.183	.109	.156	1.681	.106
	ES	.176	.133	.119	1.326	.198
	NE	.376	.103	.317	3.645	.001

a. Dependent Variable: S

The formula of multiple regression usually developed by looking at the unstandardized coefficients B. Because the independent variables of this research were measured in different measurement units, the formula was supposed to be constructed using standardized coefficients. Standardized constant amount for the value is the easier way to define the effects regardless measurement units differences (Craig and Douglas, 2005). In the enter method, each variable is included in the final model, regardless of whether it is statistically significant (Nardi, 2005). Therefore, the standardized formula based on the coefficient table is:

$$S = -0.202 EC + 0.523 WC + 0.273 WM + 0.156 EP + 0.119 ES + 0.317 NEM$$

Based on the formula, we could conclude that:

1. Energy Consumption, Water Consumption, Waste Management, Environment Preservation, Equality in Society, Noise, and Emission Management will give influence towards sustainability at SME in automotive component industry in Bekasi Regency.
2. If the value of Energy Consumption is increasing by 1%, with the assumption of constant value of Water Consumption, Waste Management, Environment Preservation, Equality in Society, and Noise Emission Management (*ceteris paribus*), it will decrease the value of sustainability of SME in automotive component industry in Bekasi Regency by 0.202%.
3. If the value of Water Consumption is increasing by 1%, with the assumption of constant value of Energy Consumption, Waste Management, Environment Preservation, Equality in Society, and Noise Emission Management (*ceteris paribus*), it will increase the value of sustainability of SME in automotive component industry in Bekasi Regency by 0.523%.
4. If the value of Waste Management Consumption is increasing by 1%, with the assumption of constant value of Energy Consumption, Water Consumption, Environment Preservation, Equality in Society and Noise Emission Management (*ceteris paribus*), it will increase the value of sustainability of SME in automotive component industry in Bekasi Regency by 0.273%.
5. If the value of Environment Preservation is increasing by 1%, with the assumption of constant value of Energy Consumption, Water Consumption, Waste Management, Equality in Society, and Noise Emission Management (*ceteris paribus*), it will increase the value of sustainability of SME in automotive component industry in Bekasi Regency by 0.156%.
6. If the value of Equality in Society Consumption is increasing by 1%, with the assumption of constant value of Energy Consumption, Water Consumption, Waste Management, Environment Preservation, and Noise Emission Management (*ceteris paribus*), it will increase the value of sustainability of SME in automotive component industry in Bekasi Regency by 0.119%.
7. If the value of Noise and Emission Management is increasing 1%, with the assumption of constant value of Energy Consumption, Water Management, and Waste Management (*ceteris paribus*), it will increase the value of sustainability of SME in automotive component industry in Bekasi Regency by 0.317%.

### The Stepwise Multiple Regression Analysis

The researcher continue to find the fit model to answer the second problem statement, that is how the pattern of the current sustainability. Therefore the regression linear test by using stepwise were made by using sustainability as the criterion (dependent variable), and all independent variables as predictors. Doing this test in SPSS, the independent variables will be filtered, with the criteria p-value is less than 0.05. There are three variables that fulfilled these criteria, they are Water Consumption,

Waste Management, and Noise and Emission Management as the predictors (independent variable). Table 14. shows the result of filtering the independent variable from SPSS. It shows that from all independent variable inserted, there are only three variables that is necessary to predict sustainability, since it fulfills the criteria of stepwise, that probability  $F \leq 0.05$ .

**Table 14. Variables Entered/Removed**

Model	Variables Entered	Variables Removed	Method
1	WC		Stepwise (Criteria: Probability-of-F-to-enter $\leq .050$ , Probability-of-F-to-remove $\geq .100$ ).
2	WM		Stepwise (Criteria: Probability-of-F-to-enter $\leq .050$ , Probability-of-F-to-remove $\geq .100$ ).
3	NEM		Stepwise (Criteria: Probability-of-F-to-enter $\leq .050$ , Probability-of-F-to-remove $\geq .100$ ).

a. Dependent Variable: S

Table 15 shows how many predictors account of the variance in sustainability. There are 3 models, and the model with highest adjusted R-square is model 3, where water consumption, waste management, and noise and emission management used as the predictors. Taken as a set of predictors, Water Consumption, Waste Management and Noise and Emission Management, account for 81.1% of variance in sustainability.

**Table 15. Model Summary**

Model	R	R Square	Adjusted R Square	Std. Error of the Estimate
1	.773 <sup>a</sup>	.598	.583	2.782481
2	.852 <sup>b</sup>	.726	.705	2.340617
3	.911 <sup>c</sup>	.831	.811	1.872660

a. Predictors: (Constant), WC

b. Predictors: (Constant), WC, WM

c. Predictors: (Constant), WC, WM, NEM

Continue to look at the Table 16, it shows the probability of F to enter or significance level of p-value in the model 3. The result shows that the p-value is  $\leq 0.05$ , therefore the model 3 shows that the predictors Water Consumption, Waste Management, and Noise and Emission Management are able to account significant amount of variance in sustainability.

**Table 16. ANOVA**

Model	Sum of Squares	Df	Mean Square	F	Sig.
1 Regression	322.185	1	322.185	41.614	.000 <sup>b</sup>
1 Residual	216.782	28	7.742		
Total	538.967	29			
2 Regression	391.048	2	195.524	35.689	.000 <sup>c</sup>
2 Residual	147.919	27	5.478		
Total	538.967	29			
3 Regression	447.788	3	149.263	42.563	.000 <sup>d</sup>
3 Residual	91.178	26	3.507		
Total	538.967	29			

a. Dependent Variable: S

b. Predictors: (Constant), WC

c. Predictors: (Constant), WC, WM

d. Predictors: (Constant), WC, WM, NE

The significant of each predictor individually can be seen by looking at the Table 17. The focus is on model 3, since it accounts for the biggest amount of variance sustainability. The table aboveshow that all predictors are significance individually, since the p-value  $\leq 0.05$ .

**Table 17. Coefficients**

Model	Unstandardized Coeff.		Standardized Coeff.	T	Sig.
	B	Std. Error	Beta		
1 (Constant)	8.730	1.384		6.309	.000
WC	1.233	.191	.773	6.451	.000
2 (Constant)	5.853	1.419		4.125	.000
WC	.922	.183	.578	5.032	.000
WM	.459	.129	.407	3.545	.001
3 (Constant)	2.882	1.354		2.128	.043
WC	.726	.154	.455	4.701	.000
WM	.439	.104	.389	4.232	.000
NEM	.416	.103	.350	4.022	.000

a. Dependent Variable: TS

Based on the discussion above the current sustainability pattern can be generated by looking at the model 3, that says that there are 3 variables that necessary to predict sustainability at SME in automotive component industry. they are Water Consumption, Waste Management, and Noise and Emission Management. The current sustainability pattern is:

$$S = 0.455 WC + 0.389 WM + 0.350 NEM$$

### Interpretation of Result

This research made to answer two problem statements. The first problem statement is to find the relationship between each independent variable toward dependent variable. The researcher draw the hypotheses to predict the result of research, based on the literature review that presented in previous chapter. However, not all of hypoteses is accepted, there are certain condition based on the data gathered and the sample characteristic that become the reason for this condition.

#### 1. Energy Consumption toward Sustainability of SME in Automotive Component Industry in Bekasi Regency

The first hypothesis predict that there are positive significant relationship between energy consumption and sustainability. While the result of data analysis by using SPSS shows that the amount of standardize coefficient B is (-0.202) and the value of significance is 0.056. The negative sign in the standardize coefficient B value indicates the negative relationship is exist between energy consumption and sustainability. While the level of significance is bigger than 0.05 (margin of error = 5%) indicates that the relationship is un-significant. Therefore the first hypothesis is rejected.

Not-significant means there is no special contribution that can differ energy consumption with the other variable toward sustainability or it means the correlation is zero.

After looking at the set of data that gathered from 30 respondents, the result indicates that the respondent that involved in this research agree that the moment they focus on energy consumption, in this case, invest in renewable energy, keep minimizing the energy consumption and keep paying attention to sustainability in choosing the energy, it will result to the lower sustainability level of the company. It shows by the feedback that dominated by "1" and "2" means that the respondent never do the mention activities or they never do the mention activities but have a plan to do it.

The study indicates that focus being sustainable in energy consumption will reduce the sustainability instead. The example of renewable energy that presented in the questionnaire is solar energy, the most feasible renewable energy that can be utilized, hoever for SME, this utilization of solar energy will result in more investment to make. They will need to install the panel and sacrificed certain amount of money. Well for this size of enterprises, they prefer to allocate the money for the other activities to improve the performance of the company.



Therefore they can conclude that by making more investment in energy, it will reduce the company sustainability, it could be in the economic, social, and environment sustainability. It is supported by the statement of Fatimah, Biswas, Mazhar, & Islam (2013) that presented in the literature review mentioning that the characteristic of SME is insufficient capital investments, therefore they also lack of innovative technology.

In the other side, various literatures mentioned that the energy consumption will result in sustainability, this variable still not becoming the goal of SME in automotive component industry to achieve sustainable practice. It is supported by Linnenluecke and Griffiths (2010) mention that sustainability requires organizational change and adaptation in different levels. Every organization and industry has their own goal in sustainability that different from one to another.

## 2. Water Consumption toward Sustainability of SME in Automotive Component Industry in Bekasi Regency

The second hypothesis predict that there are positive significant relationship between water consumption and sustainability. Compared to the result of data analysis, the amount of standardize coefficient B is (+0.523) where positive sign indicates positive relationship, and the significance value is 0.000 which is less than 0.05 (5% margin of error) that means the positive relationship that exist is significance. Therefore the second hypothesis is accepted.

Significant means there is special contribution that can differ water consumption with the other variable toward sustainability or it means the correlation is not zero.

The research indicates that the SME in automotive component industry agree that by improving activities in hazardous waste water disposal, put an effort to re-use the water from non-production activities, and concern to minimize the water usage, will improve the sustainability of the company. It means that they agree on that activity in water consumption will help the company to become more sustainable it could be in social, economic, and environment and it becomes one of their goal in sustainability. It is align with Sodhi and Yatskovlava (2013) that also agree on the company activities on sustaining the water consumption.

## 3. Waste Management toward Sustainability of SME in Automotive Component Industry in Bekasi Regency

The third hypothesis predict that there are positive significant relationship between waste management and sustainability. The result of data analysis, the amount of standardize coefficient B is (+0.273) where positive sign indicates positive relationship, and the significance value is 0.012 which is less than 0.05 (5% margin of error) that means the positive relationship that exist is significance. Therefore the third hypothesis is accepted.

Significant means there is special contribution that can differ waste management with the other variable toward sustainability or it means the correlation is not zero.

The result indicates that the respondent believe by minimizing the waste production, re-use and recycle, sort the waste, and keep trying to improve the waste processing, it will result in the higher sustainability for the company. Means that waste management is becoming the important factors and becoming one of sustainability goal in the SME in automotive component industry. It is also supported by Ali, Cotton, and Westlake (2005) that proper solid waste disposal is an important component of environmental sanitation and sustainability.

## 4. Environment Preservation toward Sustainability of SME in Automotive Component Industry in Bekasi Regency

The fourth hypothesis predict that there are positive significant relationship between environment preservation and sustainability. The result of data analysis shows that the amount of standardize coefficient B is (+0.156) which indicates positive relationship and the significance is 0.106 which indicates the established relationship is un-significant. Therefore the fourth hypothesis is rejected.

It indicates that eventhough the company agree that preserved the environment will contribute to the sustainability, the contribution to the sustainability is not significant. It means there is no special contribution that can differ environment preservation with the other variable toward sustainability or it means the correlation is zero.

Looking at the data, the respond at the each statement under environment preservation is good enough, two third of the respondent ever do more than half of the total activities that included in the questionnaire. But when looking at the respond to the statement S4, "This company practicing sustainability by keep trying and concern on environment preservation", the majority responden respond by low scale. It means that the respondent do not confident enough to say that their effort in preserving the environment can contribute to the sustainability. Since strong definition of sustainability

that related to the environment preservation said that sustainability means that every component or subsystem of the natural environment, every species, and every physical stock must be preserved (Pearce & Atkinson, 1995), while the respondent just do the tiny part of it.

#### 5. Equality in Society toward Sustainability of SME in Automotive Component Industry in Bekasi Regency

The fifth hypothesis predict that there are positive significant relationship between equality in society and sustainability. The result of data analysis shows that the amount of standardize coefficient B is (+0.119) which indicates positive relationship and the significance is 0.198 which indicates the established relationship is un-significant. Therefore the fifth hypothesis is rejected.

It indicates that eventhough the company agree that equality in society t will contribute to the sustainability, the contribution to the sustainability is not significant. It means there is no special contribution that can differ equality in society with the other variable toward sustainability or it means the correlation is zero.

The data shows that eventhough most of company respond each statement of equality in society statement with high scale, some of the respondent provide lower scale in responding to the S5 that is "This company practicing sustainability by keep trying and concern on equality in society" with the high scale. It means the company do not confidence enough to respond with high scale, or aline with their respond toward statement under equality in society variable. It is related toward their goal in sustainability, it shows that the current main concern on sustainability of SME in automotive component company is not on providing the equality in society. In fact the score in this variable is almost perfect, but it is not included in the company's goal in sustainability.

#### 6. Noise and Emission Management toward Sustainability of SME in Automotive Component Industry in Bekasi Regency

The sixth hypothesis predict that there are positive significant relationship between noise and emission management and sustainability. The result of data analysis shows that the amount of standardized coefficient B is (+0.317) where the positive sign means the positive relationship, and the amount of significance is 0.001 which is less than 0.05 (5% margin of error) indicates that the establish positive relationship is significant. Therefore the sixth hypothesis is accepted. Significant means there is special contribution that can differ noise and emission management with the other variable toward sustainability or it means the correlation is not zero..

This result indicates the respondent agree that noise and emission management can improve the sustainability practice of the company. In this study, noise and emission management include the concern of choosing the technology that produce less noise and emission, put an effort to prevent the issue of increasing average temperature, and highly consider the additional working hour that can cause more noise and emission. The noise and emission management seen as an important issue for the company, it also supported by Randolph and Masters (2008) that emission is the problem of the century and Olayinka (2012) that mention that there is imminent health risk of noise to the exposed population.

The second problem statement of this research is find the current pattern (fit-model) of sustainability by using stepwise in linear regression. The result of data analysis shows that there are three variables that necessarily account or contribute significantly toward sustainability of SME in automotive component industry in Bekasi Regency. These three variables are water consumption, waste management, and noise and emission management.

The three variables are the variable that fulfill the criteria that is the amount of significance is less than 0.05 (5% margin of error) or in other words significantly contribute toward sustainability. Significant means each of these three variable have special contribution to the sustainability. Water consumption has its own special contribution, that different from waste management and noise and emission management. Waste management has its own special contribution, that different from water consumption and noise and emiaaion management. Noise and emission management also has its own special contribution, that different from water consumption and waste management.

From all the model created, the combination of these three variables result in the highest adjusted R-squared, that means high contribution of the variable toward sustainability in SME of automotive component industry in Bekasi Regency. The amount of adjusted R-squared is 81.1%. Therefore, the current pattern of sustainability is summarize in this following equation:

$$S = 0.455 WC + 0.389 WM + 0.350 NEM$$

Based on the formula, we could conclude that:

1. There are three necessary independent variables that account for the current sustainability pattern (fit model) of SME in automotive component industry in Bekasi Regency. They are Water Consumption, Waste Management, and Noise and Emission Management.
2. If the value of Water Consumption is increasing by 1%, with the assumption of constant value of Waste Management and Noise and Emission Management (*ceteris paribus*), it will increase the value of sustainability of SME in automotive component industry in Bekasi Regency by 0.455%.
3. If the value of Waste Management is increasing by 1%, with the assumption of constant value of Water Consumption and Noise and Emission Management (*ceteris paribus*), it will increase the value of sustainability of SME in automotive component industry in Bekasi Regency by 0.389%.
4. If the value of Noise and Emission Management is increasing by 1%, with the assumption of constant value of Water Consumption and Waste Management (*ceteris paribus*), it will increase the value of sustainability of SME in automotive component industry in Bekasi Regency by 0.350%.

## Conclusion

The objective of this research is to analyze the relationship between energy consumption, water consumption, waste management, environment preservation, equality in society, and noise and emission management toward sustainability in the SME in automotive component industry. This research also aim to know the current sustainability pattern of SME in automotive component industry, especially in Bekasi Regency.

After conducting analysis to achieve research objectives, there are several results obtained:

1. The multiple regression shows that 3 variable has positive relationship and significant, they are water consumption, waste management, and noise and emission management. One variable that is energy consumption has negative relationship and un-significant. While the rest two variables environment preservation and equality in society having positive relationship but not-significant. It is due to the respondent feedback that is not confident enough to include the two variables sustainability.
2. After test the data with regression linear by using stepwise in SPSS, it is found that there are three variables that necessary contribute to the current sustainability pattern, they are water consumption, waste management, and noise and emission management.

$$S = 0.455 WC + 0.389 WM + 0.350 NEM$$

## Recommendation

The recommendation of this research is focus on two different things, the first one is for the SME in automotive component industry especially that located in Bekasi Regency, and the second one is future researcher.

For the the company that has similarity with the respondent in this research, that is SME in automotive component industry located in Bekasi Regency, the result of this research can become the guidance for applying sustainability in the company, because this research creates the pattern of sustainability that currently applied in the industry. The result also help the company to know and understand the current sustainability concern in the industry.

For the future researcher, there are some opportunities that can be developed from this research. Going back to the previous chapter where the researcher listed down all of the limitation of this research, at the same time the limitation of this research is an opportunity for the other researcher to explore more about the similar topic.

The variable of sustainability can be expanded, since sustainability is a very broad topic. The areas of research, which in this research only cover Bekasi Regency while in fact the SME in automotive component industry is not only located in Bekasi Regency. And the last is the amount of respondents used in this research is using minimum amount for the big sample that is 30. There is opportunity to conduct the research and generate more sample in the future, to increase the level of confidence of the research result.

## References

- Ghozali, I. (2009). *Ekonometrika: Teori, Konsep, dan Aplikasi dengan SPSS 17*. Semarang: Badan Penerbit Universitas Diponegoro.
- Kohl, T. A., & Resource Associates Corporation. (2011). *A Common Sense Approach to Sustainability*. Pennsylvania: Delta Books. Retrieved from [www.theinstituteforsustainability.com](http://www.theinstituteforsustainability.com).
- Malhotra, N. K. (2010). *Marketing Research: An Applied Orientation*. Pearson Education.
- Nardi, P. M. (2005). *Interpreting Data*. Boston: Pearson.
- Pearce, D. W., & Atkinson, G. (1995). Measuring sustainable development. In D. W. Bromley, *The Handbook of Environmental Economic*. Blackwell: Oxford.
- Craig, C. S., & Douglas, S. P. (2005). *International Marketing Research*, John Willey & Sons. Efficiency in the US Economy, McKinsey & Co., New York, NY.
- Dewayana, T. S., Sugiarto, D., & Hetharia, D. (2013). Identification of Selection Criteria for Green Automotive Component Industry. *The 4th Green Technology Faculty of Science and Technology Islamic of University State Maulana Malik Ibrahim Malang* (pp. 424-429). Malang: Islamic of University State Maulana Malik Ibrahim Malang.
- Ernst & Young and GreenBiz Group. (2012). Six growing trends in corporate sustainability. Dusseldorf, Germany: EYGM Limited.
- Fatimah, Y. A., Biswas, W., Mazhar, I., & Islam, M. N. (2013). Sustainable manufacturing for Indonesian small-and medium-sized enterprises (SMEs): the case of remanufactured alternators. *Journal of Remanufacturing*.
- Kontic, L. & Kontic, J. (2012). Sustainability and readiness for change: insights from a banking case study in serbia. *Economic Inferences*, 19 (No. 32). Retrieved from [http://amfiteatruconomic.ro/Home\\_Ro.aspx](http://amfiteatruconomic.ro/Home_Ro.aspx)
- Kulkarni, S., Rao, P., & Patil, Y. (2014). Are the Non-Reewable Resource Utilization and Waste Management Practices Employed in Indian Automobile Sector Sustainable? *Procedia - Social Behavioral Sciences*, 133, 364 - 371.
- Linnenluecke, M. K., & Griffiths, A. (2010). Corporate sustainability and organizational culture. *Journal of World Business*, 45, 357-366.
- Meadows, D., & et., a. (1972). *The Limits to Growth*. London: Potomatic Associates. Montiel, I., 2008. Corporate social responsibility and corporate sustainability separate pasts, common futures. *Organization & Environment*, Iss. 21, pp.245-269.
- Olayinka, O. S. (2012). Noise Pollution in Urban Areas: The Neglected Dimensions. *Environment Research Journal*, 6(4), 259 - 271.
- Rodriguez, S. I., Roman, M. S., Sturhahn, S. C., & Terry, E. H. (2002). *Sustainability Assessment and Reporting for the University of Michigan's Ann Arbor Campus*. University of Michigan, Center for Sustainable Systems. Michigan: Center for Sustainable Systems University of Michigan. Retrieved December 7, 2014, from [http://css.snre.umich.edu/css\\_doc/CSS02-04.pdf](http://css.snre.umich.edu/css_doc/CSS02-04.pdf)
- Sodhi, M.S., Yatskovskaya, E. (2014). Developing a sustainability index for companies' efforts on responsible use of water. *International Journal of Productivity and Performance Management*, 63(7), 800 – 821.

- USAID and SENADA. (2007). *Tinjauan Rantai Nilai Industry*. Jakarta: United States Agency for International Development.
- Wilkinson, A., Hill, M., & Gollan, P. (2001). The Sustainability Debate. *International Journal of Operations & Production Management*, 1492-1502.
- World Business Council for Sustainable Development and SNV. (2004). *Promoting Small and Medium Enterprises for Sustainable Development*. WBCSD.
- Zavodna, L. S. (2011). Key Performance Indicators for Measuring Sustainability. *Economics Management Innovation*, 54-63.
- Zavodna, L. S. (2013). Sustainability as a Part of Balanced Scorecard. *Challenges of the Knowledge Society. Business Administration and Marketing*, 1018 - 1025.
- Ali, M., Cotton, A., & Westlake, K. (2005, June). *Factsheet: WELL*. Diambil kembali dari WELL: <http://www.lboro.ac.uk/well/resources/fact-sheets/fact-sheets-htm/waste.htm>
- Attah, N. V. (2010). *Environmental Sustainability and Sustainable Growth: A Global Outlook*. Pennsylvania: University of Pennsylvania.
- Circular Ecology. (2014). *Resources: Circular Ecology*. Retrieved December 9, 2014, from Circular Ecology: <http://www.circularecology.com/sustainability-and-sustainable-development.html#.VlaJA9KSwue>
- Harris, J. M. (2003, February). Sustainability and Sustainable Development. Retrieved from The International Society for Ecological Economics: <http://isecoeco.org/pdf/susdev.pdf>
- Randolph, J. & Masters, G.M.(30 June 2008). Energy for Sustainability. Retrieved from: <http://books.google.co.id>
- World Commission on Environment and Development. 1987. Our Common Future. London: Oxford University Press.

# **AGING POPULATION IN EAST JAVA AND DEMOGRAPHIC CHARACTERISTICS**

Rachmah Indawati

Corresponden: Rachmah Indawati, Kampus C Fakultas Kesehatan Masyarakat Universitas Airlangga,  
Jl. Mulyorejo Surabaya 60115; e-mail: [rachindawati@yahoo.com](mailto:rachindawati@yahoo.com); phone: 081332096665

## **Abstract.**

The process of population aging can be seen from several indicators. The aim are to identify the aging society and demographic characteristics of the population. This study was a 'secondary analysis of data'. Source of data derived from the central bureau of statistics East Java province.

East Java in the fourth stage of the demographic transition. Some indicators show that the median ages was towards the age of 31.03 years old. Total population aged 65+ (7.07%) and some areas the percentage is exceeded the East Java. High dependency ratio of 51.29 and life expectancy is over 70 years in most districts/cities. The East Java province has undergone aging population. Demographic characteristics of the population indicated by conditions of poverty. The older people with low education and economic dependency is high. At the level of individuals and families showed many vulnerable families and the number of violence in the elderly is quite high. Most of the elderly without a spouse. And composition more in women. The conclusions are demographic conditions indicate socio-economic status of the population. And this variable that must be considered because it can affect the health status of the population.

Keywords: Demographics, East Java province, population, and aging

## **Introduction**

Population and the aging population are two things that each need attention in the field of public health studies. The aging population has become an interesting phenomenon because it affects the lives of individuals, families, and communities. Aging itself is a problem in the social, economic and health. Related to health is declining physical condition in older population itself or rising chronic disease. In the social field associated with decreased social interaction either with family or friends. Social activities are less likely to cause these elderly people experience psychological problems such as the problem of loneliness, melancholy, and stress. While in the field of economics is the economic burden on families in meeting their daily needs.

Knowledge of the aging population is very important in predicting the future. Demographic transition is a theory that is used to determine the aging population in the region. The indicator used is the population pyramid, the proportion of age, median age, aging index, dependency ratios, and life expectancy [1, 2].

Furthermore, to give an overview of demographic, especially in old age is to find the various aspects of life of the elderly by identifying demographic variables. The purpose of research are to identify the aging society and demographic characteristics of the population in East Java. Benefits can provide information about aging and linkages with health and social variables as well as an indicator to determine the magnitude of the problem of population.

## **Method**

This research is a 'secondary analysis of data' means to obtain information about the aging population and demographic characteristics is done by reviewing the data from various sources. Source of data derived from the central bureau of statistics East Java province. The data needed are matters relating to the structure and composition of the population. Demographic characteristics include age distribution, sex, education, marital status, income, participation in the work force, and demographic conditions relating to individuals, families and communities.

Data analysis using descriptive analysis by performing a frequency distribution. Identify the number of elderly, gender differences, population distribution by region, and health conditions.

## Results

### Aging population

Demographic transition is a theory that is useful to look at the demographic and social changes in a population. To see the demographic structure of the population as a result of the aging process, the multiple indicator is to look at the population pyramids shape, proportion of age, median ages, aging index, dependency ratios, and life expectancy. Population pyramids in East Java in 1971 is different from the year 2010.

In 1971, a triangular pyramid shape is tapered. Characterized by a large number of births (broad at the base) and low old age and life expectancy is still low. Population pyramids in East Java in 2010 showed that in the age range 24-49 years is the large number, the fertility rate is still high, a larger number of women than men. In 1971, a triangular pyramids shape is tapered. Characterized by a large number of births (broad at the base) and low old age and life expectancy is still low. Population pyramids in East Java in 2010 showed that in the age range 24-49 years is the large number, the fertility rate is still high, a larger number of women than men. Based on the age and sex structure in the year 2010 the population pyramids shape in East Java are both at the bottom and the top of a triangle is widened. The triangular shape is critical because some of the problems is when a member of the cohort has been moving towards old age. Within a period of 30 years and over, the number of members of the cohort in the elderly group was great. The proportion of the age is used to make comparisons between regions or across time in the history of a region. The proportion of age gives an overall picture of the structure of the population. Nevertheless, the trend in the proportion of age in the community can provide an important indicator of the aging population. The proportion of the population aged 65+ years is 7.07%.

Table 1. Number of population by age group and gender in East Java 2010

Age (years)	Male	Female	Total Male and Female	Percentage (%)
1	2	3	4	5
0-4	1,498,239	1,425,671	2,923,910	7.80
5-9	1,595,931	1,512,068	3,107,999	8.29
10-14	1,634,120	1,549,091	3,183,211	8.49
15-19	1,519,736	1,490,804	3,010,540	8.03
20-24	1,362,425	1,409,361	2,771,786	7.40
25-29	1,537,732	1,591,284	3,129,016	8.35
30-34	1,465,879	1,515,454	2,981,333	7.96
35-39	1,491,393	1,531,820	3,023,213	8.07
40-44	1,427,306	1,489,709	2,917,015	7.78
45-49	1,271,139	1,339,772	2,610,991	6.97
50-54	1,114,596	1,114,987	2,229,583	5.95
55-59	873,437	817,769	1,691,206	4.51
60-64	588,666	657,955	1,246,621	3.33
65-69	464,700	547,935	1,012,635	2.70
70-74	319,297	448,662	767,959	2.05
75-79	180,912	275,701	456,613	1.22
80-84	99,824	155,417	255,241	0.68
85-89	38,503	61,309	99,812	0.27
90-94	12,200	23,028	35,228	0.09
95+	7,481	15,444	22,925	0.06
Total	18,503,516	18,973,241	37,476,757	100,00

Source: Population census 2010

The median ages is often used in conjunction with the aging population. The median is the midpoint of the range of values of age. East Java has a median age of 31.03 years. Some regions have been moving towards old age. There are four districts showed a median ages above the East Java. Pacitan is a district "oldest" in East Java, has an average age of 35.16 years. Sampang district that is "youngest" in East Java, has an average age of 25.09 years is very low. This information shows the reproductive period/fertility patterns of the population has experienced a shift towards adult/elderly.

Table 2. The median ages by region in East Java 2010

No.	Region	Median ages	Rank	No.	Region	Median ages	Rank
1	2	3	4	1	2	3	4
1.	Pacitan	35.16	1	20.	Magetan	35.13	2
2.	Ponorogo	35.07	3	21.	Ngawi	30.70	5
3.	Trenggalek	30.57	6	22.	Bojonegoro	30.45	9.5
4.	Tulungagung	30.37	13	23.	Tuban	30.23	18
5.	Blitar	30.45	9.5	24.	Lamongan	30.37	13
6.	Kediri	30.19	19	25.	Gresik	25.78	30
7.	Malang	30.15	20	26.	Bangkalan	25.25	37
8.	Lumajang	30.33	16	27.	Sampang	25.09	38
9.	Jember	30.09	22	28.	Pamekasan	25.51	36
10.	Banyuwangi	30.38	11	29.	Sumenep	30.46	8
11.	Bondowoso	30.47	7	30.	Kediri city	25.77	31
12.	Situbondo	30.36	15	31.	Blitar city	30.08	23
13.	Probolinggo	30.10	21	32.	Malang city	25.56	35
14.	Pasuruan	25.73	32.5	33.	Probolinggo city	25.73	32.5
15.	Sidoarjo	25.82	29	34.	Pasuruan city	25.58	34
16.	Mojokerto	30.04	24.5	35.	Mojokerto city	30.01	26
17.	Jombang	30.04	24.5	36.	Madiun city	30.37	13
18.	Nganjuk	30.31	17	37.	Surabaya city	25.88	28
19.	Madiun	35.05	4	38.	Batu city	27.14	27

Source: Population census 2010

Aging index is the ratio of the elderly (60+) for children under the age of 15 years. Aging index is a direct measure of the age structure of the population, tells how many older people for every 100 children under the age of 15 years. In 2010, almost all districts/cities in East Java has the aging index of less than 100. This indicates a relatively young population. In East Java has the aging index of 28.76 and most of the district/cities have higher than East Java. In Pacitan area has 53.03 aging index (higher than most districts/cities in East Java). While the Sidoarjo district has an index of aging of the youngest among the districts/cities in East Java, namely 15.89. In Sidoarjo, aging index 16 per 100 illustrates that 16 parents for every 100 children. Aging index is an indicator that the community needs to face the allocation of resources.

Table 3. Aging index by region in East Java 2010

No.	Region	Aging index	Rank	No.	Region	Aging index	Rank
1	2	3	4	1	2	3	4
1.	Pacitan	53.03	1	20.	Magetan	52.51	2
2.	Ponorogo	49.11	3	21.	Ngawi	41.32	6
3.	Trenggalek	42.10	5	22.	Bojonegoro	34.12	10
4.	Tulungagung	36.06	8	23.	Tuban	29.81	20
5.	Blitar	39.56	7	24.	Lamongan	32.18	14
6.	Kediri	30.88	17	25.	Gresik	18.41	35
7.	Malang	30.56	18	26.	Bangkalan	22.41	29
8.	Lumajang	30.35	19	27.	Sampang	16.48	37
9.	Jember	28.10	22	28.	Pamekasan	20.23	31
10.	Banyuwangi	33.19	13	29.	Sumenep	31.64	15
11.	Bondowoso	35.39	9	30.	Kediri city	24.04	27
12.	Situbondo	31.56	16	31.	Blitar city	28.61	21
13.	Probolinggo	25.72	25	32.	Malang city	24.66	26
14.	Pasuruan	19.42	33	33.	Probolinggo city	19.53	32
15.	Sidoarjo	15.89	38	34.	Pasuruan city	16.96	36
16.	Mojokerto	24.00	28	35.	Mojokerto city	22.05	30
17.	Jombang	27.40	23	36.	Madiun city	33.96	11
18.	Nganjuk	33.73	12	37.	Surabaya city	18.64	34
19.	Madiun	43.23	4	38.	Batu city	27.06	24



Source: Population census 2010

The dependency ratios is the proportion of people who are considered dependent 'economy' those under the age of 15 years (young dependency ratios) and over the age of 64 (the old dependency ratios). The dependency ratio is similar to the proportion of the age, but calculated with a slightly different way and interpreted in very different ways. The proportion of age in the community is simply the number of parent divided by the population. Age dependency ratios is the number of older people divided by the number of people aged 15 to 64. This is interpreted as the number of parents for every person of working age (sometimes expressed as the number of elderly people per 100 people of working age).

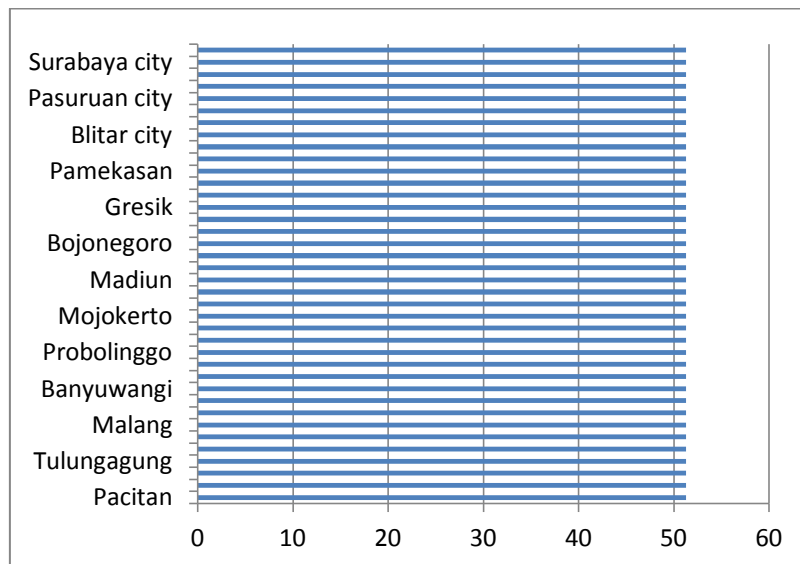


Figure 1. The dependency ratios in some areas of East Java

Source: Population census 2010

The figure above shows the dependency ratios in all regions in East Java is the same 51.29. Source of data is not accurate, it can happen the possibility of human error (wrong type or individuals do not carefully observe). If the data is assumed to be true then the dependency ratios is the information from all regions have more young people 51 and older for every 100 people of working age. This pattern suggests that high fertility and high mortality. Many children were born, and many parents who died, generates a low proportion of older people and a high proportion of children are relatively similar to the working age population.

The life expectancy is the average length of time members of the population can be expected to live. The life expectancy of each region is different, some district/city has a life expectancy of over 70 years. Blitar city has the longest life expectancy of 72.23 years and Probolinggo district has the shortest life expectancy of 61.13 years. Increased life expectancy impact on changes in family structure. The role is responsible for the generation to older people. In traditional societies, the task of the parents' role will be taken by the older children as economic needs.

Table 4. Life expectancy by region in East Java 2010

No.	Region	Life expectancy	Rank	No.	Region	Life expectancy	Rank
1.	Pacitan	71.26	5	20.	Magetan	71.17	6
2.	Ponorogo	69.93	17	21.	Ngawi	69.91	18
3.	Trenggalek	71.62	2	22.	Bojonegoro	67.15	28
4.	Tulungagung	71.48	4	23.	Tuban	67.78	25
5.	Blitar	70.88	10	24.	Lamongan	68.20	24
6.	Kediri	69.66	19	25.	Gresik	70.98	9
7.	Malang	68.96	21	26.	Bangkalan	63.32	33
8.	Lumajang	67.17	27	27.	Sampang	63.00	36
9.	Jember	62.84	37	28.	Pamekasan	63.99	32
10.	Banyuwangi	67.58	26	29.	Sumenep	64.71	30

11.	Bondowoso	63.23	34	30.	Kediri city	70.41	12
12.	Situbondo	63.19	35	31.	Blitar city	72.23	1
13.	Probolinggo	61.13	38	32.	Malang city	70.32	13
14.	Pasuruan	64.01	31	33.	Probolinggo city	70.17	15
15.	Sidoarjo	70.55	11	34.	Pasuruan city	66.37	29
16.	Mojokerto	70.19	14	35.	Mojokerto city	71.56	3
17.	Jombang	70.09	16	36.	Madiun city	71.01	8
18.	Nganjuk	68.89	23	37.	Surabaya city	71.01	7
19.	Madiun	68.90	22	38.	Batu city	69.44	20

Source: Population census 2010

Aging population is measured from the ranks of several indicators, then performed an average ranking. Goal to obtain the sequence of aging population by region. The measurement results show that the aging population that is rapidly aging population is in the district. Consecutive district is Pacitan, Magetan, Trenggalek, Ponorogo, and Tulungagung. In urban areas, rapid population aging process occurs in Madiun. And in the successive Gerbangkertasusila is Lamongan, Mojokerto regency, Surabaya, Gresik, Sidoarjo and Bangkalan.

Table 5. Summary of several indicators of the aging population in East Java 2010

No.	Region	Median ages (Rank)	Aging index (Rank)	Life expectancy (Rank)	Average rank
1	2	3	4	5	$6=(3+4+5)/3$
1.	Pacitan	1	1	5	1
2.	Ponorogo	3	3	17	4
3.	Trenggalek	6	5	2	3
4.	Tulungagung	13	8	4	5
5.	Blitar	9,5	7	10	6
6.	Kediri	19	17	19	16
7.	Malang	20	18	21	20
8.	Lumajang	16	19	27	21
9.	Jember	22	22	37	32
10.	Banyuwangi	11	13	26	11
11.	Bondowoso	7	9	34	12
12.	Situbondo	15	16	35	24
13.	Probolinggo	21	25	38	33
14.	Pasuruan	32.5	33	31	34
15.	Sidoarjo	29	38	11	31
16.	Mojokerto	24.5	28	14	22
17.	Jombang	24.5	23	16	18
18.	Nganjuk	17	12	23	14
19.	Madiun	4	4	22	8
20.	Magetan	2	2	6	2
21.	Ngawi	5	6	18	7
22.	Bojonegoro	9.5	10	28	17
23.	Tuban	18	20	25	23
24.	Lamongan	13	14	24	13
25.	Gresik	30	35	9	29
26.	Bangkalan	37	29	33	35
27.	Sampang	38	37	36	38
28.	Pamekasan	36	31	32	37
29.	Sumenep	8	15	30	15
30.	Kediri city	31	27	12	26
31.	Blitar city	23	21	1	10
32.	Malang city	35	26	13	30
33.	Probolinggo city	32.5	32	15	27
34.	Pasuruan city	34	36	29	36
35.	Mojokerto city	26	30	3	19
36.	Madiun city	13	11	8	9
37.	Surabaya city	28	34	7	25

38.	Batu city	27	24	20	28
-----	-----------	----	----	----	----

Source: Population census 2010

An increasing number of aging population occur in some areas in East Java. According to the Central Bureau of Statistics of East Java (2013), the national socio-economic survey in 2012 showed that the population of the age group 65+ is 37,879,713. And the proportion of the population aged 65+ years at 5.68%. While the results of the population census 2010 East Java, the total population in 2010 was 37,476,757. And the proportion of the population aged 65+ years at 7.07% [3]. If these data are compared to the decrease of 1.39%. The big difference in this data will certainly have difficulty in planning development, especially in the field of health. Nonetheless, East Java has experienced a demographic transition characterized by declining birth rate and the increasing number of elderly.

Furthermore, the results of the ranking aging population by region and result ranking number of elderly (65+) in each region is not too different. The table below shows the percentage of the elderly (65+), in Pacitan and Magetan still ranks highest of all regions. That is Pacitan and Magetan is a region experiencing the aging process and the Elderly is the greatest percentage. Sidoarjo have order the youngest and elderly percentage is 3.45%.

Table 6. Percentage of elderly (65+) and gender in East Java in 2012

No.	Region	Male (%)	Female (%)	Total	Rank*	Rank**
1	2	3	4	5	6	7
1.	Pacitan	9.19	13.09	11.18	2	1
2.	Ponorogo	8.01	11.79	9.90	3	4
3.	Trenggalek	8.03	9.65	8.85	7	3
4.	Tulungagung	7.93	8.94	8.45	8	5
5.	Blitar	8.14	962	8.88	6	6
6.	Kediri	6.58	8.36	7.47	14	16
7.	Malang	6.10	8.84	7.46	15	20
8.	Lumajang	6.20	8.00	7.12	18	21
9.	Jember	5.97	8.05	7.03	19	32
10.	Banyuwangi	7.26	9.19	8.23	9	11
11.	Bondowoso	6.06	9.91	8.03	11	12
12.	Situbondo	5.29	8.63	7.00	21	24
13.	Probolinggo	4.85	7.99	6.46	24	33
14.	Pasuruan	3.78	5.34	4.57	34	34
15.	Sidoarjo	2.75	4.16	3.45	38	31
16.	Mojokerto	5.08	7.03	6.05	27	22
17.	Jombang	5.81	7.47	6.65	23	18
18.	Nganjuk	7.54	870	8.12	10	14
19.	Madiun	8.13	11.25	9.17	4	8
20.	Magetan	9.19	13.16	11.22	1	2
21.	Ngawi	7.50	10.97	9.28	5	7
22.	Bojonegoro	6.65	8.76	7.72	12	17
23.	Tuban	5.21	8.51	6.88	22	23
24.	Lamongan	5.66	8.28	7.01	20	13
25.	Gresik	3.05	4.94	4.00	37	29
26.	Bangkalan	4.99	7.40	6.25	26	35
27.	Sampang	4.05	6.43	5.27	30	38
28.	Pamekasan	3.57	6.40	5.02	33	37
29.	Sumenep	6.09	8.44	7.32	16	15
30.	Kediri city	4.61	7.02	5.82	28	26
31.	Blitar city	6.42	7.99	7.21	17	10
32.	Malang city	4.42	6.04	5.24	31	30
33.	Probolinggo city	4.15	6.06	5.12	32	27
34.	Pasuruan city	3.42	5.14	4.29	35	36
35.	Mojokerto city	4.50	6.03	5.28	29	19
36.	Madiun city	5.99	9.22	7.65	13	9
37.	Surabaya city	3.72	4.42	4.28	36	25
38.	Batu city	5.65	7.09	6.36	25	28

Source: National socio-economic survey 2012

Note: \*= Rank elderly (65+); \*\*= Rank aging population by region; box color= number of elderly (65+) exceeds the percentage of East Java (7.07%).

#### Demographic characteristics

This section of the description of the basic demographic population in East Java. The aim to provide an overview of the facts among many population characteristics such as labor force participation, geographic distribution, education, and gender. Some other demographic characteristics and important to look at the phenomenon of the aging process, such as health and socio-economic aspects, both at the individual, family and community. Socio-economic conditions at the individual level indicates the percentage of the total labor force (group of the 60+) was lower than the percentage of the elderly (65+). This means that most of the older age is not productive. Percentage of total workforce in some areas in East Java is still lower than the regional figure (5.07%). All areas of the city shows the total labor force (60+) is low.

Some areas facing social problems. Serious social problems afflict the elderly is an act of violence. The numbers vary widely with a range of 0-171 cases. In the district of violence often occurs in Tulungagung, Banyuwangi, Bondowoso, Nganjuk, Bangkalan, and Madiun. While in urban areas the most violent acts occur in Blitar and Malang.

Table 7. Number of population and socio-economic characteristics at the individual level in East Java 2012

No.	Region	Total population <sup>1)</sup>	Age (65+) (%) <sup>*</sup>	Total population (60+) <sup>**</sup>	Total labor force (60+) (%) <sup>**</sup>	Eldelry <sup>2)</sup> who are victims of violence <sup>***</sup>
1	2	3	4	5	6	7
1.	Pacitan	544,229	11.18	54,744	10.06	37
2.	Ponorogo	860,218	9.90	67,567	7.85	0
3.	Trenggalek	678,791	8.85	57,891	8.53	4
4.	Tulungagung	999,640	8.45	73,259	73.29	171
5.	Blitar	1,126,151	8.88	83,484	7.41	0
6.	Kediri	1,514,132	7.47	82,678	5.46	36
7.	Malang	2,473,612	7.46	126,453	5.11	27
8.	Lumajang	1,014,625	7.12	55,220	5.44	56
9.	Jember	2,355,283	7.03	112,385	4.77	0
10.	Banyuwangi	1,568,956	8.23	106,169	6.77	163
11.	Bondowoso	744,067	8.03	55,595	7.47	89
12.	Situbondo	654,153	7.00	45,705	6.99	0
13.	Probolinggo	1,108,584	6.46	63,123	5.69	43
14.	Pasuruan	1,531,025	4.57	44,544	2.91	8
15.	Sidoarjo	1,981,096	3.45	39,208	1.98	22
16.	Mojokerto	1,039,477	6.05	41,109	3.95	15
17.	Jombang	1,214,086	6.65	45,674	3.76	31
18.	Nganjuk	1,025,416	8.12	53,487	5.22	99
19.	Madiun	666,519	9.17	48,170	7.23	60
20.	Magetan	626,851	11.22	52,111	8.31	0
21.	Ngawi	826,213	9.28	54,850	6.64	0
22.	Bojonegoro	1,217,850	7.72	67,540	5.55	37
23.	Tuban	1,129,050	6.88	44,709	3.96	0
24.	Lamongan	1,191,239	7.01	53,401	4.48	39
25.	Gresik	1,196,124	4.00	34,306	2.87	0
26.	Bangkalan	919,002	6.25	48,193	5.24	75
27.	Sampang	891,982	5.27	32,873	3.69	0
28.	Pamekasan	808,057	5.02	42,803	5.30	15
29.	Sumenep	1,051,763	7.32	71,763	6.82	0
30.	Kediri city	271,655	5.82	8,678	3.19	0
31.	Blitar city	133,578	7.21	6,062	4.54	24
32.	Malang city	829,094	5.24	28,944	3.49	10
33.	Probolinggo city	220,086	5.12	8,011	3.64	2
34.	Pasuruan city	188,545	4.29	4,688	2.49	0

35.	Mojokerto city	121,645	5.28	3,346	2.75	0
36.	Madiun city	172,351	7.65	7,525	4.37	1
37.	Surabaya city	2,791,761	4.28	84,621	3.03	2
38.	Batu city	192,807	6.36	9,143	4.74	2
	Total	37,879,713	6.79	1,920,032	5.07	15,97

Source: 1)= National socio-economic survey 2012, Labor force situation 2012, and East Java in figure 2013 are same; \*= National socio-economic survey 2012; \*\*= Labor force situation 2012; \*\*\*= East Java in figure 2013; <sup>2</sup>Elderly= There is no criteria for the elderly age in East Java in figures 2013.

Problems in health is declining physical condition of the elderly. In 2010 in East Java, the number of elderly (65+ years) experience difficulties as much vision is 429.350. Hearing loss is 429.350. Difficulty walking is 382.481. Difficulty in remembering is 284.817. And 236.215 impaired in performing daily activities [3].

Table 8. Number of population and socio-economic characteristics at the family level in East Java 2012

No.	Region	Total population*	Poor families ***	The family lived in the house is not habitable ***	Average net salary for 1 month **	Total Education has not been to school **	Education has not been to school (%)**	Vulnerable families***
1	2	3	4	5	6	7	8= 7/3	9
1.	Pacitan	544,229	36,488	11,370	1,222,8222	15,208	2.79	2,468
2.	Ponorogo	860,218	23,250	10,568	1,485,805	42,681	4.96	689
3.	Trenggalek	678791	18,289	2,545	1,211,051	17,848	2.63	2912
4.	Tulungagung	999,640	22,280	8,661	1,089,960	8,810	8.81	78
5.	Blitar	1,126,151	33,294	2,700	881,668	15,415	1.37	391
6.	Kediri	1,514,132	36,333	5,537	1,128,385	34,754	2.30	973
7.	Malang	2,473,612	75,680	10,122	1,189,342	60,077	2.43	3,481
8.	Lumajang	1,014,625	30,536	9,324	905,346	42,873	4.23	820
9.	Jember	2,355,283	96,120	15,158	898,675	136,372	5.79	150
10.	Banyuwangi	1,568,956	117,891	12,819	994,708	55,925	3.56	1,699
11.	Bondowoso	744,067	105,257	35,459	1,136,265	45,644	6.13	8,104
12.	Situbondo	654,153	50,832	28,422	888,678	65,157	9.96	639
13.	Probolinggo	1,108,584	68,220	10,647	1,324,016	82,963	7.48	1,151
14.	Pasuruan	1,531,025	107,590	15,282	1,192,111	30,388	1.98	4,740
15.	Sidoarjo	1,981,096	15,081	1,348	1,666,007	2,654	0.13	742
16.	Mojokerto	1,039,477	33,725	6,256	1,334,577	8,165	0.79	694
17.	Jombang	1,214,086	28,275	7,746	1,245,549	9,191	0.76	443
18.	Nganjuk	1,025,416	49,180	6,792	1,454,894	27,973	2.73	1,804
19.	Madiun	666,519	45,942	8,123	1,367,327	25,228	3.79	1,046
20.	Magetan	626,851	34,170	8,194	1,568,905	10,908	1.74	965
21.	Ngawi	826,213	55,271	13,604	1,276,028	43,564	5.27	706
22.	Bojonegoro	1,217,850	69,309	7,960	1,346,484	38,549	3.17	4,694
23.	Tuban	1,129,050	0	1,694	1,097,259	34,958	3.10	6,616
24.	Lamongan	1,191,239	1,763	198	1,197,003	18,840	1.58	335
25.	Gresik	1,196,124	11,800	488,873	1,610,914	15,070	1.26	3,697
26.	Bangkalan	919,002	11,713	2,828	1,551,718	95,778	10.42	24
27.	Sampang	891,982	145,059	11,967	930,567	147,549	16.54	1,148
28.	Pamekasan	808,057	52,947	26,139	1,197,794	146,034	18.07	60
29.	Sumenep	1,051,763	37,389	10,234	1,281,840	146,100	13.89	371
30.	Kediri city	271,655	1,815	178	1,600,030	585	0.22	230
31.	Blitar city	133,578	3,451	273	1,554,656	543	0.41	353
32.	Malang city	829,094	4,890	980	1,535,728	6,425	0.77	242
33.	Probolinggo city	220,086	3,457	761	1,737,660	4,086	1.86	76
34.	Pasuruan city	188,545	4,089	410	1,489,737	1,356	0.72	82
35.	Mojokerto city	121,645	4,386	343	1,225,161	1,055	0.87	92
36.	Madiun city	172,351	5,132	119	1,371,356	1,124	0.65	21
37.	Surabaya city	2,791,761	21,306	2,658	1,424,313	26,564	0.95	811
38.	Batu city	192,807	2,023	226	1,308,204	1,547	0.80	54
	Total	37,879,713	1,464,233	786,518	1,317,407	1,476,896	3.90	53,451

Source: \*= National socio-economic survey 2012; \*\*= Labor force situation 2012; \*\*\*= East Java in figure 2013; Elderly= There is no set criteria for the elderly age

The table above shows that the number of large families in East Java in poor criteria. Meanwhile, the condition of the house uninhabitable also great. The data also showed a lot of vulnerable families. Low socio-economic conditions will result in a limitation in the family. Individuals in

the family can experience the social disorder, mental, illness onset. When viewed from a social-psychological problems in family shows 7,294 families of the total population of 37,879,713 at East Java. In addition, morbidity in the family for the past 1 month showed 26.93% of the population has health complaints [4].

Other social characteristics is education. Most of the population (aged 15+ years) with low formal education (not attending school). Madura has very different characteristics compared to districts/cities in East Java. Many of the residents have not experienced formal education. Each are Bangkalan (10.42%), Sampang (16.54%), Pamekasan (18.07%), and Sumenep (13.89%). In addition, the family income is low and relatively large number of vulnerable families, especially in Sampang. With the percentage increasing number of aged 65+ Madura will face serious problems related to the allocation of resources.

Percentage of population by marital status shows that the elderly are not married, divorce is a life or death is large enough. And women have the highest percentage for each category of marital status. In elderly (65-69 years of old), the total population who experience divorce dead (50.73%), who had divorced 2.32%, and 0.70% were unmarried.

Table 9. Percentage of population by age group and marital status in East Java 2012

Age (year)	Unmarried (%)	Marrid (%)	Life of divorce (%)	Death of divorce (%)
55-59	Male (1,09) Female (1,24) Total (1,16)	Male (92,34) Perempuan (65,11) Total (78,97)	Male (1,37) Female (3,81) Total (2,57)	Male (5,20) Female (29,84) Total (17,29)
60-64	Male (0,41) Female (0,98) Total (0,70)	Male (90,54) Female (50,61) Total (70,01)	Male (0,88) Female (4,01) Total (2,49)	Male (8,17) Female (44,40) Total (26,80)
65-69	Male (0,62) Female (0,75) Total (0,70)	Male (77,55) Female (24,20) Total (46,25)	Male (1,36) Female (3,00) Total (2,32)	Male (20,47) Female (72,04) Total (50,73)

Source: National socio-economic survey 2012

The composition of the population of East Java by sex indicated by the number of males for every 100 females. The sex ratio in East Java is 97 or lower than the national rate is 101 [5]. When compared with the number of East Java in Sumenep district has the lowest sex ratio of 90.75 this means 91 men to 100 women. And the highest sex ratio above 100 is a stone city is 101.28 This means that 101 males to 100 females. Some areas have been above the regional figure of East Java province. Sex ratio shows differences in mortality between the sexes, the pattern of life and social interaction settings.

Table 10. Composition of gender by region in East Java 2010

No.	Wilayah	Sex ratio	Rank	No.	Wilayah	Sex ratio	Rank
1	2	3	4	1	2	3	4
1.	Pacitan	95.43	26	20.	Magetan	94.96	33
2.	Ponorogo	99.98	6	21.	Ngawi	95.08	31
3.	Trenggalek	98.79	12	22.	Bojonegoro	97.83	18
4.	Tulungagung	95.16	29	23.	Tuban	97.65	19
5.	Blitar	100.41	5	24.	Lamongan	94.49	35
6.	Kediri	100.79	4	25.	Gresik	98.38	14
7.	Malang	101.10	2	26.	Bangkalan	91.48	37
8.	Lumajang	95.45	25	27.	Sampang	95.11	30
9.	Jember	96.71	24	28.	Pamekasan	94.62	34
10.	Banyuwangi	99.08	9	29.	Sumenep	90.75	38
11.	Bondowoso	94.97	32	30.	Kediri city	99.45	8
12.	Situbondo	95.24	28	31.	Blitar city	98.37	15
13.	Probolinggo	95.32	27	32.	Malang city	97.32	21
14.	Pasuruan	98.22	16	33.	Probolinggo city	97.07	22
15.	Sidoarjo	101.02	3	34.	Pasuruan city	98.38	13
16.	Mojokerto	99.85	7	35.	Mojokerto city	96.82	23
17.	Jombang	99.03	10	36.	Madiun city	93.78	36
18.	Nganjuk	98.89	11	37.	Surabaya city	97.87	17
19.	Madiun	97.48	20	38.	Batu city	101.28	1

Source: Population census 2010

East Java has a human resource allocation great but most of the population has a low formal education (no school to elementary school). And of unemployment mostly with low education (no school to elementary school). In addition, most of the public perception is not possible to get a job (39.14%). And people who are find a job (19.55%).

Table 11. Socio-economic characteristics at the level of society at the age of 15+ years in East Java

No	Socio-economic characteristics (15+ tahun)	Frequency	Percentage (%)
1.	Education ( includes labor force)		
	– Never education	570,761	29.73
	– Not completed elementary school	663234	34.54
	– Elementary school	491,997	25.62
	– Junior high school	100,160	0.52
	– High school	66,797	3.48
	– Diploma	10,143	0.53
	– Universitas	16,940	0.08
	Total	1,920,032	100.00
2.	Education (unemployment)		
	– Never education	1,119	19.78
	– Not completed elementary school	2,035	35.98
	– Elementary school	696	12.31
	– Junior high school	660	11.67
	– High school	951	16.81
	– Diploma	0	0.00
	– Universitas	195	3.45
	Total	5,656	100.00
3.	Education (unemployment)		
	– Find a job	1,106	19.55
	– Preparing a business	1,293	22.86
	– Feeling impossible to get a job	2,214	39.15
	– Already have a job but have not started working	1,043	18.44
	Total	5,656	100.00
4.	The main job (working for 1 week ago)		
	– Agriculture, forestry, hunting, fishing	1,249,050	65.25
	– Mining and quarrying	9,169	0.48
	– Processing industry	106,340	5.55
	– Electricity, gas, and water	246	0.01
	– Building	33,325	1.74
	– The wholesale, retail restaurants, hotels	352,102	18.39
	– Transport, storage and communications	42,701	2.23
	– Finance, insurance, leasing of buildings, land, services companies	9,080	0.47
	– Social services, social individual	112,363	5.87
	Total	1,914,376	100.00
5.	The main job (working for 1 week ago)		
	– Trying own	406,862	21.25
	– Trying to help, temporary workers/not paid	717,375	37.47
	– Trying to help, permanent workers/paid	94,926	4.96
	– Labor/employee	133,947	7.00
	– Free Workers in agriculture	199,092	10.40
	– Free workers non-agricultural	50,130	2.62
	– Worker/not paid	312,044	16.30
	Total	1,914,376	100.00

Source: Labor force situation 2012

## **Discussion**

### **Aging population**

The process of population aging occurs when the population distribution toward older ages [1, 2, 8]. The size is based on the population census of 2010 compared with the 1971 population census showed that all districts in East Java has experienced a demographic transition. Pacitan and Magetan the region are aging faster than districts/cities in East Java. The proportion of the population aged 65+ years also showed the greatest number. While the district of Sidoarjo district is the slowest aging process occurs. The several indicators of showed that Sidoarjo is the final arrangement.

Demographic transition has shown an increase in life expectancy. Most of the districts/cities have a life expectancy of more than 65 years. Long life will certainly affect a society that needs to be explored further link the aging population and other demographic conditions. According to Albert & Freedman (2010) is an important phenomenon in the next life, especially facing the elderly population. There are 3 complex interactions related to health conditions. There are morbidity, disability and mortality.

### **Demographic conditions**

Due to the aging population, several demographic characteristics that arise are:

1. The rapid growth of population age 65+ years old in the last 30 years
2. The number of women more than men
3. The number of elderly with low education is high and large dependency burden.
4. In the older age group 65+ years largely not have a partner (not married, divorced live and dead)
5. The incidence of poverty and vulnerability of the population and family health conditions in individuals.
6. Diseases which arise due to aging individuals

Demographic characteristics can affect not only the individual but also to the family and community. According to Robert (1998) where the relationship is very complex social and economic characteristics of a community can affect a person's level of education, income and employment. Source of data to prove that low levels of education and less economically productive than a society and are associated with the crime rate is quite large. By contrast, in the level of the individual and the family, socioeconomic status can affect the environment in which the individual lived.

Studies Rueda & Artazcoz (2009). the relationship between socio-economic conditions, the characteristics of family and social support on health outcomes (perceived acceptance own health condition, mental health status, and restrictions in pain). The results show that the health status of women to health outcomes worse than men. Elderly with limited life giving relationship positively associated with health outcomes. And social support provides a negative relationship to health outcomes. Research conducted in the age group 70-85 years showed that the unfavorable social position as a cause of disease. Moreover, the different education and income can predict different health conditions [11]. Similarly, it was found that sociodemographic factors provide variation differences in health status (perception of his own health, physical mobility and morbidity [12, 13]. The results of the above studies identified that there is a relationship of social life and health environment and impact the quality of life of the elderly. Social interaction is necessary and prevent poor health.

Many of the elderly who live alone. This condition allows the elderly will experience an unusual life. Impact in the last half of the journey of life is poor health status of the elderly. A study conducted to see association between live itself and the quality of life shows that life itself is a problem on the activities, discomfort and anxiety/depression. Results of the study also concluded that the necessary social interactions per week can reduce the risk of depression [14]. Research of social conditions demographic (age, sex, marital status, education), social (social contacts), and health (daily activities) to valuation differences of life in old age. The result showed there are association between socio-demographic factors, health to valuation of life. And after controlling for age showed there is positive adaptability to the aging process [15].

## **Conclutions**

Variable education, income, employment, poverty is a construct of variable socioeconomic conditions. Socioeconomic status may characterize the welfare of population. Age and sex is a variable that can provide information on the socioeconomic conditions. In addition, these variables can also be an indicator of health status.



## **Acknowledgement**

The authors are grateful to the Central Bureau of Statistics of East Java for its support of research data.

## **References**

1. Morgan, L.A. & Kunkel, S.R. (2007) *Instructor's Guide Aging, Society, and The Life Course* third Edition by Dawn C. Carr, New York: Spinger Publishing Company.
2. Albert, S.M. & Freedman, V.A.. (2010). *Public Health and Aging Maximizing Function and Well-Being* Second Edition, New York: Spinger Publishing Company.
3. Central Bureau of Statistics of East Java Province. (2011). *Towards a New Era of East Java Province The Analysis of Population Profile Results of Population Census 2010*. Surabaya: Central Bureau of Statistics.
4. Central Bureau of Statistics of East Java Province. (2013). *East Java in Figures, 2013*, Surabaya: Central Bureau of Statistics.
5. Central Bureau of Statistics. (2010). *Indonesian Population by Province and District/City Population Census 2010*, Jakarta: Central Bureau of Statistics.
6. Central Bureau of Statistics of East Java Province. (2013). *National Socio-Economic Survey of 2012 East Java*. Surabaya: Central Bureau of Statistics.
7. Central Bureau of Statistics of East Java Province. (2013). *Labor Force Condition in East Java 2012 East Java Province*. Surabaya: Central Bureau of Statistics.
8. S. Tamher & Noorkasiani. (2009). *Kesehatan Usia Lanjut dengan Pendekatan Asuhan Keperawatan*, Jakarta: Salemba Medika.
9. Robert, S.A. (1998). *Community Level Socioeconomic Status Effects on Adult Health*. *Journal of Health and Social Behavior*; March; 39, 1; ProQuest Sociology, 18-37.
10. Rueda, S. & Artazcoz, L. (2009). *Gender Inequality in Health among Elderly People in a Combined Framework of Socioeconomic Position, Family Characteristics and Social Support*, *Aging and Society* 29, 625-647, doi: 10.1017/So144686X08008349, 625-647.
11. Anson, O. & Paran, E. (2010). *Socioeconomic Position and Health at Old Age: Results from 6-years Follow up Study*. *Social Theory and Health*, Macmillan Publishers Ltd. 1477-8211; vol 8, 2, 175-191.
12. G.K. Mini. (2009). *Socioeconomic and Demographic Diversity in The Health Status of Elderly People in a Transitional Society, Kerala India*. *Journal Biosocial science*, 41, doi: 10.1017/S0021932008003003, 457-467.
13. Pirani, E. & Salvini, S. (2012). *Socioeconomic Inequalities and Self Rated Health: a Multilevel Study of Italian Elderly*. *Population Research Policy Rev*, 31, doi 10.1007/s1111301192190, 97-117.
14. Sun, X., Lucas, H., Meng, Q., & Zhang, Y. (2001). *Associations between Living Arrangements and Health Related Quality of Life of Urban Elderly People: a Study from China*. *Quality Life Research*, 20, doi: 10.1007/s11136-010-9752, 359-369.
15. Jopp, D., Rott, C. & Oswald, F. (2008). *Valuation of Life in Old and Very Old Age: The Role of Sociodemographic, social, and Health Resources for Positive Adaptation*. *The Gerontologist* October, 48; 5, ProQuest Sociology, 646.

## IMPACT ANALYSIS OF FOLK COCOA PLANTATION DEVELOPMENT TOWARD THE ECONOMIC DEVELOPMENT IN SOUTHEAST ACEH DISTRICT

Sunawardi, Student of Doctoral Program, PW-SPs USU  
Abdul Rauf, Suwardi Lubis and HBTarnizi Graduate School Lecturer of USU

### ABSTRACT

Cocoa plays an important role for the economy, in particular; as providers of employment, sources of local revenue and foreign countries, but in its development undergoes a variety of problems, in particular; problems of land and its processing and product marketing which lead to its sustainability is threatened. In the economic growth of Southeast Aceh District, many sectors play roles in shaping GDP in regional economic development. This study aimed to analyze the impact of the development of the folk cocoa plantations towards the economic development of the Southeast Aceh District. The study was conducted in September 2013 until February 2014 with a survey method. Data analysis was performed by Input-Output analysis, Multiple Regression Analysis and Prospective analysis. Research showed that the role of folk cocoa plantation reached rapid development until 2012, the economic output of the agricultural sector contributed 37% in GDP until 2012, with a total production reached 6,230 tons of dry beans. Regional Gross Domestic Product (GDP) of Southeast Aceh at the period of 2009 to 2012 continued to grow, GDP at current prices amounted to 1.064.400, 22 rupiahs increased to 1.390.474, 33 rupiahs. The main sector that drove economic growth was agricultural sector. This sector was very dominant in the formation of GDP in Southeast Aceh District; its role tended to increase from year to year. In 2009 the agricultural sector accounted for 53% increased to 58% in 2012. In 2009, the number of cocoa farmers reached 11.735 people increased to 15.508 people in 2011, that number reached 9% of workers in Southeast Aceh district. Cocoa economic sector had an output multiplying value which was relatively small if compared to other economic sectors. The value of the total output multiplier for cocoa sector was 1.2124 composing of 1.0000 initial multipliers followed by 0.1272 the first stage multipliers and 0.2305 household consumption multipliers and cocoa economic sector had a multiplier value of total income amounted to 0.1697 and was in the first position of the 12 economic sectors in the analysis

Keywords: Development, economy, cocoa

### INTRODUCTION

Regional development planning is a planning process that is intended to make changes toward a better development for a community, governments and the environment in a particular region or area, by utilizing or utilizing a variety of existing sources, and should have an orientation that is comprehensive and complete, but stick to the principle of priority (Nasution MA, 2008).

Planning in agricultural sector felt very strategic moment in which on one hand the existence of land to farmland becomes increasingly narrow. On the other hand the needs of production grow greater. In this regard, it needs arrangements and in-depth analysis so that the cultivation can maximize the results with the right commodity.

In addition, the Agricultural Sector is considered to have a strategic role in the provision of employment, the provision of food, and the state foreign exchange contributor through exports and so on. The agricultural sector plays a major role in the construction and development of the regions (Munandar, 2001).

Agricultural development with zoning leading commodity that is done today is expected to create a balance and harmony of the environment and land use patterns can be set according to the optimal agricultural commodities and agricultural commodity territories can be arranged well, in particular, leading commodities (L.Tobing FH, 2011) ,

In the Master Plan of Indonesian Economic Enhancement, one of the mainstay plantation commodities in Indonesia is Cocoa along with oil palm and rubber. Cocoa is also one of the leading commodities in the province of Aceh.

Cocoa is being one of the commodities whose role is quite important for the national economy, in particular, as a provider of employment, income and foreign exchange sources of the State, until 2012 total cocoa land reached 1.5 million hectares with a total production reached 833 310 tones, with prices up to September 2012 reached US \$ 2,577, the foreign exchange earnings of US \$ 2.14 billion (derived from cocoa beans and processed ones). In general, agriculture in the broad sense through 2012 has been absorbing 41.20503 million labors (Source BPS).

Indonesia is the world's second largest cocoa producer, by donating 18 percent of the global market. Nationally, cocoa commodities produce the third largest foreign exchange earner after oil palm and rubber. Processed cocoa beans produce cocoa butter and cocoa powder that is needed by the world community, especially in America and Europe, in which demands for cocoa have reached 2.5 million tons per year. Indonesia' target in 2025 is supposed to be capable of producing 2.5 million tons of cocoa beans with export value of USD 6.25 billion. According to data ICCO (International Coffee and Cocoa Organization) World cocoa demands have continued to grow around 2-4 percent per year, even in the last 5 years grow 5 percent per year (3.5 million tons / year). China and India are countries with a large population become potential cocoa market of Indonesia (Anonymous, 2011).

Cocoa in Southeast Aceh Regency is one of the leading commodities which has an important role in the development of the economy because in addition to being a source of Community income, is also expected to become one of the regency's original source of revenue which is potential enough. The market opportunity is still open as well as the quality and quantity of the best production in the province of Aceh is a potential that should be considered in the development of cocoa (Anonymous, 2011).

As a result of economic growth and roles of an economic sector in regional economy which has not accounted for the value of depletion and environmental degradation will result in that society must bear the cost of the externalities of a process of production or economic activity. This is a result of economic development planning based on the results of previous development so that there is the possibility of development which is planned to be more aggravating environmental degradation and increasing the burden of external costs to be borne by the community.

Cocoa plantations have a strategic significance for the economy of the Southeast Aceh Regency, but in its development, there are several agricultural commodities are large enough to contribute to the regional economy. On the other side, Southeast Aceh Regency is the main production center of cocoa in the province of Aceh. It is therefore necessary to study to depict descriptions and information, in particular, to policy makers and agribusiness cocoa actors on

how big cocoa sector's role for the regional economy of Southeast Aceh Regency, especially, in generating output, Gross Domestic Product (GDP), exports, employment supplies and income sources, as well as its role in driving the regional economy.

### 1. Regional Planning Theory

In the area of development efforts, the most important issues to be the attention of economists and regional planning are related to economic growth and equitable development if viewed from the difference between the theory of regional economic growth and national economic growth theory lying in the nature of openness in the process of input-output of goods and services as well as persons within the system of the circulation of goods, persons, and services are open, but nationally are more closed (Sirojuzilam, 2007).

According Solihin D, 2005; Regional Development Planning is a systematic effort of various actors, both public or the Government, private sector and other community groups at different levels in the face of interdependence and interconnectedness of the physical, social, economic and other environmental aspects by means of (1) continuously analyzing the conditions and implementing regional development, (2) formulating goals and policy of regional development, (3) drafting strategies for solving the problems (solution), and (4) implementing them using the available resources so that new opportunities to improve the welfare of local communities can be improved continuously.

### 2. Development Theory

Development is often associated with efforts to improve per capita income. Its success indicator is the increase in national income (GNP) per capita; it is apparently pointed out in the initial thoughts about the construction by Harrod-Domar theory, Arthur Lewis, WW Rostow, Hirschman and Leibenstein, but around 1960, when the macro data can be compared internationally has been available, the economists found that development is not only economic dimension, but multidimensional (Kuncoro, 2003).

The reality in developing countries indicates that growth is not synonymous with development. High economic growth in the early stages of development may be achieved, even exceeded the level of advanced countries, but growth is accompanied by the emergence of development issues such as unemployment, rural poverty, unequal distribution of income and the structural imbalance (Sjahrir, 1986). This indicates that the vast dimensional development is not just economic growth so that the experts feel the need to engage in a reexamination of the meaning of development. Economic development is no longer priority to the growth of GNP as development goals, but needs to be more focus on quality and the development process.

According Kuncoro (2003), during the decade of the 70s, the definition of economic development is manifested in the effort to eliminate or at least reduce poverty, unemployment and inequality. To realize these goals the development of new concepts and strategies come up such as: growth with distribution, with the development strategy of basic needs, self-development, development with attention to income inequality according to ethnicity, and sustainable development with attention to nature / environment.

Once the complexity of development leads to many theories arise and there is no one right development theory to be applied in all countries of the World. Theories of development which are at the initial stage dominated by the ideas of the western economies, so these are not always suitable to be applied in developing countries, these conditions spurred the emergence of new theories about development because so many development theories formulated by

economists which are rather difficult to categorize them in a certain flow. However, according Kuncoro (2003), there are at least five groups of development theories, namely: a. Theory of linear growth, b. structural growth theory, c. international dependence revolution theory, d. neo-classical theory, and e. new theories.

### 3. Development of Sustainable Development Theory

Economic development theories developed to the present time generally more emphasize on growth and efficiency and less notice the aspects of natural resources and the environment. According to Capra (2002), aspects of natural resources and the environment are actually ones of the elements that exist on the classical economic model, but because at the beginning of the development of the theory is still abundant with natural resources and population is still small. So, paying attention to natural resources is not a central issue at the time.

The presumption of the abundant natural resources continues to be used for further development of economic models, even the Neo-Classical flow has eliminated the factor of natural resources of the economic model they developed. This model just concentrates on two variables, namely human resources and capital, while social and environmental variables excluded, thereby enabling the development of the analogous economic model to a controlled experimental physical science, but the economic model becomes unrealistic and the success of the development is "false", because the environment destruction is due to economic activities externalized resulting in negative impacts for the community, in particular; around the natural resources exploitation.

Economic conditions which are built on the economic model more firmly stated by Brown (1995), states that the current world economic systems gradually begin to destroy themselves for economic activities generally which cause damage and degradation of the environment. If the economy supporting system continues to damage, economic growth will fall below the population growth. Therefore, it needs rapidly setting development strategy for the world community as a whole so that the world economic development has a continuation.

According to Capra (2002), to ensure the sustainability of world economic development needs concepts and theories to be revised, in particular, redefinition of "efficiency and productivity as well as the concept of profit". Efficiency is no longer biased based on the level of individuals and companies, but based on the level of ecosystems. Also, productivity is no longer defined as an output per hour of work of employees that has an impact on the automation and mechanization magnifying unemployment whose productivity equals to zero, while the concept of profit requires revision to be not considered as the personal benefit ignoring externalities such as social and environmental costs. Furthermore, drafting a new model integrates the various branches of science in a broad ecological framework.

For further stage, stated that the outline of the frame formed by a group of people who refuse to be called as economists or be associated with a single conventional academic discipline narrowly defined. The approach remains scientific. Empirical basis not only includes economic data, social, political facts, a psychological phenomenon, but also becomes a clear reference to cultural values. From this basis, the scientists will be able to build realistic and trustworthy models of economic phenomena (Capra, 2002).

#### 4. Economic Growth

An economy is said to grow if the amount of production of goods and services increased. In assessing changes in the economy's output, uses the monetary value that is reflected in the value of Gross Domestic Product (GDP). To measure economic growth is based on constant price GDP. This is caused by using constant prices, the effect of price changes has been removed, and that even if the resulting figure for the money value of goods and services output changes in the value of GDP also shows changes in the quantity of goods and services produced during the observation period.

The main purpose of calculating economic growth is eager to see whether the economy is getting better or vice versa. Economic growth is reflected in such as the increase of per capita income. In line with this, Case and Fair states (2004) that economic growth is defined as the increase in the total output of an economy which is defined by some experts as an increase in the real GDP per capita. Through economic growth of improved living standards it can be said that the economic growth brings changes in which the phenomenon of new items produced will occur resulting in old goods abandoned.

#### INPUT-OUTPUT MODEL

An Input-Output analysis model was first developed by a French economist Francois Quesnay namely in 1758 in an article entitled "Tableau Economique". In the article François Quesnay outlines how landlords receive land rents and use these to buy agricultural products and handicrafts. Farmers and artists spend money on food and raw materials and so on (Miller and Blair, 1985).

More than a century later, in 1974, Leon Walras developed a François Quesnay approach by applying Newtonian models in economics. L. Walras developed the theory of general equilibrium in economics and mathematical relationships of production factors (inputs) with products produced (output) and then the model was simplified by Wassily Leontief. Input-Output Leontief models were used to analyze the structure of the American economy published in 1911 (Miller and Blair, 1985).

Based on the results of the analysis and their development efforts for various purposes of analysis, W. Leontief got the Nobel Prize in Economic Sciences in 1973. This model of analysis or better known as Leontief model is widely recognized very useful for analyzing regional and national economic conditions in relation with the planning of economic development of a region. Tarin, 2004 suggests that the benefits of using this model are as follows:

1. Input - Output analysis can give a description of linkage between sectors of the economy as a way of expanding the horizons of the regional economy. Regional economy is no longer a collection of sectors, but an interconnected system. Changes in one sector will affect the entire sectors, although these changes will happen gradually.
2. With Input-Output Analysis, it is found the relation between backward linkage and forward Linkage of each sector, made easily to establish which sectors is used as a strategic sector in the planning of regional economy development.
3. Input-Output Analysis can predict economic growth and raising levels of prosperity, in case of increase in the final demands from various sectors. This can be analyzed through increased input between primary and raising one as an extra value (prosperity).

4. Input-Output Analysis can comprehensibly study problems, so it is very useful as a tool for regional development planning analysis.
5. Input-Output Analysis can be used to calculate the power requirements and capital in the planning of regional economy development.

#### 1. Input-Output Conventional Model

The basis of Output- Input Analysis is an analysis of the relationship of dependence amongst economic sectors within a system of regional economy in a given period (one year) and the economy is in a stable condition. Information on transactions of goods and services as well as interconnections amongst economic sectors in the region presents the form of a matrix with four quadrants (Miller and Blair and the Central Bureau of Statistics, 2010).

The first quadrant shows the flow of goods and services produced and used by the sectors in an economy. This indicates the use of goods and services distributed for the production process. The use or consumption of goods and services in question here is as raw materials or supporting materials so that the transactions of the first quadrant are referred to as a transaction between. The second quadrant indicates the final demands of goods and services used for household and government consumption, investment and exports. The third quadrant shows the primary input of production sector which is not a part of the output of it as in the first and second quadrant. The primary input is all the reward factors of production which includes wages and salaries, operating surplus, depreciation and net indirect taxes. While the fourth quadrant describes the primary input is directly distributed to the sectors of final demands. Information on this quadrant is not important information so it is often overlooked. Input-Output Illustration can be seen in Table 1 below:

Table 1: Illustration of Input-Output table

Output Allocation	Between Demand	Demand	Total
Structure sector	Production sector 1.....j.....n	Final	Output
	<b>Quadrant I</b>	<b>Quadrant II</b>	
sector 1	$X_{11}$ $X_{1j}$ $X_{1n}$	$F_1$	$X_1$
⋮	⋮	⋮	⋮
⋮	⋮	⋮	⋮
sector i	$X_i$ $X_{ij}$ $X_{in}$	$F_j$	$X_j$
⋮	⋮	⋮	⋮
⋮	⋮	⋮	⋮
sector n	$X_n$ $X_{nj}$ $X_{nn}$	$F_n$	$X_n$
	<b>Quadrant III</b>	<b>Quadrant IV</b>	
Primary input	$V_1$ $V_j$ $V_n$		
Input total	$X_1$ $X_j$ $X_n$		

Source: Central Bureau of Statistics, 2010

Based on the illustration above, it appears that using the Input-Output Table can be seen how the output of an economic sector is distributed to other economic sectors and how well an economic sector obtains a necessary input from other economic sectors. The dependence size of an economic sector is determined by the amount of inputs used in the production process and on the contrary, its supports to others determined by the total output of others'. Therefore, plans of developing an economic sector must consider the prospects for the development of other economic sectors.

In compiling Input-Output used three basic assumptions, namely: (Central Bureau of Statistics, 2010).

1. Homogeneity, each sector produces a single output with single input structure and there is no automatic substitution between various factors;
2. Proportionality, in the production process of the relationship between the input and the output is a linear function, that is; each type of input that is absorbed by a particular sector up or down in proportion to the increase or decrease in output of the sector;
3. Activity, the total effect of the implementation of production in various sectors is separately generated by each sector; this means that all outside influences of input-output system are ignored.

With the existence of these assumptions, the input-output table has limitations such as input-output ratio remains constant throughout the analysis period and the manufacturer cannot adjust the input changes or modify the production process. However, input-output models have advantages as a tool of economic analysis which is complete and comprehensive, so it is relevant to use as an analytical tool in this study to determine the linkages, in particular; folk cocoa plantations with other economic sectors and their roles for regional economy in Southeast Aceh District as well as the impact of changes in final demand on the expansion of its plantations, then by modifying it into input-output table of the people's cocoa along with other sectors for the regional economy in Southeast Aceh District.

## DISCUSSION

### 1. The role of cocoa in the Regional Economic Structure

Cocoa is one of the economic sectors that has reached the most rapid growth among the various agricultural sectors, in particular; in Southeast Aceh district. The development of cocoa economic sector can be seen from when since this commodity has turned into one of the economic sectors taken into account in the analysis of the Regional Input-Output in Southeast Aceh District since 2009. Cocoa has emerged as one of the sectors of the economy with rate significant contribution to increase the value of output, added gross value and Aceh Regional Exports and employments.

In 2010 the total value of exports of Aceh Province reached US \$ 1.34 billion or 1.7% of the total regional output of Aceh Province, it increased by 18.2% compared to the year 2009.

That was in harmony with the development of the cocoa contribution to output. And its contribution to GDP was also increasing. In 2009 this sector contributed 2,9 billion rupiahs, rapidly increased into 250 billion rupiahs in 2012, or 37% of agricultural sector contribution in the broad sense, or contributed 19% to the GDP of the Southeast Aceh district.



## 2. Role of cocoa for output formation

The structure of the economy's output of Southeast Aceh District in 2009 experienced a slight shift with the fact was that crop farming sector had more contributed to GDP such as rice and maize crops until 2003. Yet, 2009 had given another color output in which dominant one had been taken over by especially cocoa plantation sector.

Table 2: GDP of Southeast Aceh Regency Year 2009-2012  
(In millions of rupiahs)

N O	BUSINESS FIELD	GDP			
		2009	2010	2011	2012
1	2	3	4	5	6
1	Agriculture	624.482,47	658.557,69	675.703,18	743.273,49
2	Mining and Quarrying	2.029,02	2.174,59	2.327,96	2.560,75
3	Manufacturing	31.467,05	31.886,29	34.209,34	35.919,80
4	Electricity And Water	12.877,96	13.686,06	15.000,60	16.029,72
5	Building / Construction	62.961,26	80.156,82	97.076,00	105.327,46
6	Trade / Hotels / Restaurants	88.888,08	103.210,21	110.717,73	116.253,61
7	Transportation and Communications	17.035,87	17.703,71	19.525,52	20.306,54
8	Finance, Leasing and Business Services	22.110,85	24.353,33	26.916,85	28.801,02
9	Services	265.508,92	291.556,05	298.149,95	322.001,94
TOTAL		1.064.400,2	1.205.581,0	1.279.627,1	1.390.474,3
		2	4	3	3

Source: BPS and Southeast Aceh District DPKKD

If seen from Table 2 above, from year to year all sectors experienced an increase in business field, but the greatest increase widely occurred in the agricultural sector that was 9% and construction sector / construction was 9.2% while agricultural cocoa sector contributed 37% in GDP until 2012. With a total production reached 6,230 tons of dry beans.

## 3. Cocoa Role in Generating GDP

Regional Gross Domestic Product (GDP) of South East Aceh in the period 2009-2012 continued to grow, GDP at current prices amounted to 1.064.400, 22 rupiahs increased to 1.390.474, 33 rupiahs. The main sector that drives economic growth is the agricultural sector. This sector is very dominant in the formation of GDP in Southeast Aceh District. Its role tends to increase from year to year. In 2009 the agricultural sector accounted for 53% rising to 58% in 2012. Further, this contribution to GDP continuously increased in which in 2009 only accounted for 23.5% raised to 37% in 2012.

## 4. Role of Cocoa in Labor Employment

The rapid development of the cocoa plantations in Southeast Aceh Regency has a real impact for labor employment. Extending areas followed by an increase in cocoa production provides vast employment opportunities for the people, either at this sector or related other sectors such as trade cocoa and the input supply sector for production facilities.

In 2009, the number of cocoa farmers reached 11.735 people raised to 15. 508 people in 2011. That number reached 9% of workers in Southeast Aceh district.

#### 5. Role of cocoa for output multiplier

Cocoa economy sector has a multiplying output value which is relatively small compared to other economic sectors. Its total value is 1.2124 composing of 1.0000 initial multipliers followed by 0.1272 first stage multipliers followed by household consumption amounted to 0.2305.

This means that each increase of a unit of final demand for cocoa would cause an increase in the total output of Southeast Aceh District economy which equals to 2124 units. The increase in output respectively by one unit as the initial impact will have a direct impact to the input providers sector of 0.1272 units (first-round effects). This was followed by an increase in output as the effects of induction support household consumption amounted to 0.2305 units.

With the value of the output multiplier of 1.2124, cocoa economy sector has come to the third position of 12 analyzed economic sectors. The position is better than the food crop sector, fisheries, horticulture, rubber, oil palm, forestry, quarrying and services. The highest sector in Southeast Aceh Regency multiplying output goes to the economic sectors of government services and building / construction with a multiplier value respectively 2.4121 and 1.9828.

#### 6. The role of cocoa for multiplying income

Cocoa economy sector has a total income multiplying value of 0.1697 and it is at the second position of 12 analyzed economic sectors. This suggests that any increase of final demands for a unit of the cocoa economy sector will increase revenue amounted to 0.1697 units. The highest value of total income multipliers is the economic sector of government services that is equal to 0.7721.

### CONCLUSION

Based on the above discussion of the results can be concluded as follows:

1. Cacao Economic Sector has been progressing quite rapidly and gives a considerable role for the economy of the Southeast Aceh District, especially in generating output, GDP and labor absorption.
2. Development of cocoa agribusiness system in Southeast Aceh District influenced by several strategic factors which include; the availability of technology, skills of farmers, policy supports, its extensive plantations, production and productivity, training of farmers and availability of capital. Strategic factors are generally located in moderate condition and are likely to lead to pessimistic condition. If the condition is not corrected, the community's plantations continue to decrease and the sustainability will be threatened. Therefore, it is necessary to develop appropriate development strategies to improve the cocoa development strategy on an ongoing basis.

### ADVICE

1. The role of cocoa in the economic structure of Southeast Aceh district is large enough, but its support in promoting economic growth is still weak, for the necessary development of the cocoa processing industry in order to increase added value while increasing role in promoting the growth of local cocoa.
2. To reduce the cost of externalities sectors of the cocoa economy and maintain the sustainability of its plantations in Southeast Aceh District, it is necessary to repair the cocoa farming system towards more environmentally friendly.

## BIBLIOGRAPHY

- Arsyad L. 1999. Introduction to the Planning and Economic Development of Regions. BPFE, Yogyakarta.
- Adisasmita, H.R.2005. Basics of Regional Economic. Graha Ilmu.Yogyakarta,
- The Central Bureau of Statistics, 2012. Indonesia Statistics in 2012. The Central Bureau of Statistics, Jakarta.
- , 1999. The Framework Theory and Analysis of Input-Output. Central Bureau of Statistics, Jakarta.
- , 2000. Preparation Technique for Input-Output Tables. The Central Bureau of Statistics, Jakarta.
- The Central Bureau of Statistics of Southeast Aceh District 2012. Southeast Aceh In Figures. In 2011 BPS Southeast Aceh Regency, Kutacane.
- Bambang. 2003. Agribusiness Development Strategy Formulation for folk cocoa plantation in Southeast Sulawesi.Tesis. Master of Agribusiness Management. Graduate Program. Bogor Agricultural University, Bogor.
- Capra, F. 2002. Turning Point civilization. M.Thoyibi translation. Bintang Budaya, Yogyakarta.
- Economics Department of FEM IPB, 2005. Input-Output Theory. Training materials of engineering and Regional Planning Econometrics, package A. FEM IPB Department of Economics, Bogor.
- Miller, E.E. and P.D. Blair. 1985. Input-Output Analysis: Foundations and Extensions. Prentice-Hal, Inc.Englewood Cliffs, New Jersey.
- Najmulmunir, N. 2001. Impact of Economic Development toward Regional Development and quality Environment an Approach of Input-Output case in Lampung Province. Dissertation of Graduate School of Bogor Agricultural University, Bogor.

- Aceh Cocoa Economic Improvement (PEKA). 2012. Southeast Aceh Cocoa Development. Swiscontact in programs Economic Development Financing Facility (EDFF) Aceh, Banda Aceh.
- Silva, MAS, 2001. Environmental Input-Output Analysis: Application to Portugal. Master Thesis at the Universidade Tecnica de Lisboa, Instituto Superior Tecnico.<http://in3.dem.ist.utl.pt/master/thesis/99files/thesis01.pdf>.
- Sirojurzilam and Mahalli, K. 2010. Regional: Development, Planning and Ekonomi. USU Press. Medan.

# PREPARATION OF MODEL VILLAGE TOURISM AS PROPOSED FOR THE DEVELOPMENT OF SHARIA VILLAGE TOURISM IN SLEMAN DISTRICT, YOGYAKARTA, INDONESIA

Unggul Priyadi ([priyadi.unggul@yahoo.com](mailto:priyadi.unggul@yahoo.com) dan [883130101@uii.ac.id](mailto:883130101@uii.ac.id))

Eko Atmadji ([ekoatmadji@gmail.com](mailto:ekoatmadji@gmail.com))

Yasid ([yazidy59@gmail.com](mailto:yazidy59@gmail.com))

## ABSTRAK

Village tourism is an alternative offering directed to people interested in specific intent in their tourism activities. Syari'a village tourism needs not so much physical alteration from conventional one, but, instead, more fundamentally on the concept and its service delivery which is its scope is more than just culinary and accommodation. This research report is aimed to uncover models to improve village tourism, especially toward the potency of its to be converted into syari'a one. Result of this work is expected to be a proposal of the development of (syari'a) village tourism in Sleman district, DIY. Population data is gathered and the techniques to obtain are consisted of: participant observation, documentation, interview, and questionnaire. SWOT and cluster analysis are engaged. Some problems of developing village tourism are identified and strategies to resolved the troubles are established from SWOT analysis, while cluster analysis recognizes two main characteristic-category of village tourism: a). villages which enclose agro-tourism and nature and they are located close to the top of Merapi; b). villages chatacterized by individual object of tourism, such kerawitan, craft, batik, etc., and are spreadout randomly in the area outside the dangerous zone of Merapi eruption. Based on the findings recommendations are proposed.

Key words: village tourism, syari'a village tourism, syari'a concept of and syari'a service delivery in village tourism.

## Introduction

Travel and tourism is an important economic activity in most countries around the world . Both have direct and indirect impact significantly on the economy . Direct contribution of tourism to GDP reflects the expenditures 'internal' population in tourist activities as well as government spending is directly linked to visitors , such as culture ( eg museums ) or recreational ( eg national park ) . The contribution of tourism to GDP is calculated in accordance with the output - characteristic tourism sector such as hotels, airlines, airports, travel agents and tourist and recreational services that deal directly with tourists.

The contribution of tourism to include work supported by:

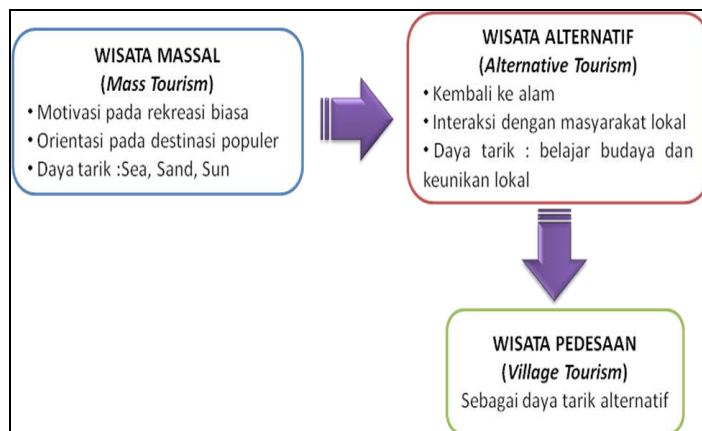
- 1) Expenditures for tourism investments such as the purchase of new aircraft and the construction of new hotels;

- 2) Government expenditure on tourism is to help tourism such as marketing and promotion of tourism, aviation, administration, security services, security services of the resort area, the resort area sanitation services, etc;
- 3) Business in the country who deal directly with tourists, including the purchase of food and cleaning services to hotels, fuel and catering services by the airline, and IT services by the travel agent.

The development of world tourism showed a sharp rise. Business is increasingly shining visit along with the increase in the prosperity of a country. Because of its multiple impacts (multiplier effect) everywhere, the tourism sector became a key factor in improving the performance of the economy of a country. Limitation of tourism cannot be determined with certainty so that the impact is estimated to be wider than expected (Vanhove, 2011).

The value of tourism is the target of many countries so that they are competing to attract the attention of tourists, especially foreign tourists. Intense competition in the tourism market eventually change its business strategy of mass travel became focused on alternative tourism. Travel tours offered alternative is for certain people who are interested in what is offered by the organizers of tourism. Among some of the key characteristics of alternative tourism are: back to nature, the interaction with local communities, and so on as illustrated below. In more detail, some tourist activities oriented nature is local culinary tours, travel experiences (usually triggers adrenaline, like surfing, rafting, hiking, tracking, etc.), Religious tourism and village tourism (or tourist villages). The purpose of holding this alternative tourism is to find customers loyal though few in number, but loyal customers is difficult to move on to another destination

Figure 1: The development orientation of tourist from mass tourism towards alternative tourism



Besides based on the nature of the objects, tourism classification can also be done by the shari'a principles. There are public tours and excursions sharia. Basically sharia tour is kind of tours offered by travel managers to Muslims. Because it is specific

to the Muslims then the presentation of this tour should meet the rules of sharia are more stringent than the general travel. Tight travel requirements of sharia does not necessarily decrease the prospect of this tour. Evidently, Islamic travel increased rapidly in non-Muslim countries such as Thailand, China, and Japan. In other words, non-Muslims were also interested in sharia because -kegiatan travel and accompanying culinary - tourism is done and served on the principle of universal values that impact safe, convenient, healthful to the perpetrators.

As one type of alternative tourism, tourist villages provide a different and unique atmosphere to the tourists so that they tend to repeat their experience on a visit in the tourist village. Trends of this tourist village is increasing in many countries. Travel related to sharia, now being built a tourist village concept of sharia. The concept is to translate the requirements of sharia into a tourist village.

Sleman as one district in Yogyakarta Province (DIY) has a very important tourism sector. DIY tourism activity is concentrated in two districts: Sleman and Gunung Kidul district. Of the two, Sleman district has long been maintaining the performance of the tourism sector for years. Therefore it would be very interesting to see the potential of the tourist village in Sleman district sharia (Anonymous, 2010). For that we need to know about the readiness and potential for sharia tourist village in Sleman district in order to be an example for other areas if it wants to develop tourism village sharia. This paper will examine the readiness and potential of district tourism tourist village of Sleman if the concept of sharia is applied. For that systematize in this paper will be structured as follows. After introductory explanations will be discussed on tour sharia and sharia tourist village. Next is a picture of a tourist village in Sleman regencies during this time. Next is the explanation of the research methods to be able to answer questions about the readiness and the potential for sharia tourist village in Sleman district. Followed by the three main analysis readiness analysis, analysis of potential tourist villages, tourist villages and modeling of sharia. The last part is the conclusion.

## 2. Background Theory

Tthis part will discuss Tourism , Travel and Sharia Village Tourism

### **a. Tourism**

Development of rural tourism can not be separated from the influence of sharia competition in the world of tourism . The tourism industry is one of the industry's most high competition ( World Economic Forum , 2013 ) due to the five pressures within the industry itself as described by Porter (1979 ) . Two of the five pressure comes from service buyers (tourists ) who demand low prices , but the products must be of high quality , suppliers of goods and services are also demanding a high price with a limited offer , two other pressure is the threat of new players into the arena of competition in the tourism market and the substitutes of the tourism industry . Final pressure is the influence of a combination of the four pressures which ultimately affects the internal competition that competition within the industry itself . This pressure causes the Fifth tough competition in the tourism industry .

Travelers have always wanted a good tour service at a low price. Cheap hotel business development (budget hotel) (Roth and Fishbin, 2015), as well as low-cost

(budget airline) (Sarker et al, 2012) is evidence that the demand for tourism services in general elastic. In addition, the growth of the tourism industry average of 3.4% per year shows that the global tourism industry is increasing. With the magnitude of this growth, business prospects bright tourism and tourism players more and more. Growth was more rapid tourism players than wisatawannya so that market growth in the tourism industry is more a buyer's market. This becomes the first pressure faced by the tourism industry. In addition, supporters of the tourism industry such as hotels, transportation, or food will be the second pressure where they will demand a higher supply than ever before. The ability to negotiate from suppliers tourism stakeholders to be a key factor if the tourism industry will increasingly generate more profit or not.

The third pressure is the threat of new players into the tourism industry. The new players are considered a threat because of two things. The first is they have fresh ideas that were not previously thought of the old players. The second is that they are mostly former workers in the tourism industry who dare to take risks for the tourism business because they have to know the industry itself. This threat would obviously depress industry profits (Besanko et.al, 2013). The fourth pressure from the tourism industry is almost non-existent. Pleasure to stay at home or the environment itself that is the substitution of tourism. The reluctance of people to go visit other places of interest it seems difficult to find but not impossible happen for various reasons. The threat of terrorism in the tourist destination tourists pose reluctance to go visit the tourist areas of interest. In addition to health factors, war, and misleading information about tourist destinations make potential tourists may be reluctant to go. If it happens, the perpetrators of tourism can certainly be overcome by offering a new destination area that is free of such fears.

The fifth is the internal pressure of competition in the tourism industry itself. The four pressure previously mentioned are things that must be faced by all of the tourism industry. The existence of these pressures cause them to be more competitive against each other tourism stakeholders. The bigger the four pressure affects the tourism industry will improve also the internal competition in the tourism industry. This competition will trigger a price war that ultimately harm the industry itself. According Besanko et.al (2013), there will be excess capacity in the industry and further decline in profits for all actors as devastating price war industry.

The way out of this situation by Besanko et.al is necessary to look alternative strategies for industry players that coopetition strategies. Coopetition strategy is a mixture of competition and cooperation (competition and cooperation). At a certain level, players are required to compete but also cooperate fully in reducing the influence of the four initial pressure so that the pressure becomes softer fifth. The intention of working together is that they form a cartel in order to face the pressure from buyers and suppliers. With the reduction of the pressure of the two internal competition becomes lighter. However, according to Stein (2010), a strategy popularized by Brandenburger and Nalebuff, has a fundamental weakness that is the strategy that is potentially confusing ambivalence cartel members. Ambivalence of competition and cooperation led to the actors in the industry (and a member of the cartel) can damage the cooperation that had been established earlier because it is difficult to homogenize the



mind to the point where they cooperate and compete. That requires strong leadership in the cartel so that uniformity of action would be reduced.

Nevertheless, the concept is actually partially cooperation has been practiced in some industries. In the electronics industry, the producers did a deal to use an electric alternating current (AC) and also a uniform definition television formats. Manufacturers in the car industry agreed to jointly promote the development of alternative energy from solar cells. The purpose of the agreement is to give more value (value) to consumers. The purpose of the more value is any purchase of goods a consumer must perceive the value (value) is more a result of consuming a product. This value is theoretically called consumer surplus. A consumer decides to buy an item because it is felt to deliver more value (benefit greater than the sacrifice of consumers to obtain a product - the goods and services) to him. Therefore, there could be a person chooses to buy a soda than tea for sodas felt to give a value greater than fizzy drinks tea even though the price is more expensive than tea.

## **b. Travel**

In essence , a tourist is " someone who has free time voluntarily used to visit a place far away from his home for the purpose of changing " ( Smith , 1989 , p . 2 ) . Tracking experts have led to their understanding that in tourism No motive , social profile , and activities carried out by " people who have spare time " is. In other words, tourism activities as described by Smith that gave answers to the questions : who are they ? Where have they traveled , and what they are looking for. ( Pearce 1982) . What is worth to note is that what they buy (pay) when conducting tourism activities is not just a food, clothing or cars, but also taste (flavor, taste) lifestyle or good experience of something. With tourism, consumption for things that delight was taken to an extreme. This means that the tourism industry is to sell not only certain objects, but world wide experience and meaning. In other words, there is a mover that drives someone to do the exchange, in this case someone buys products (tourism, pen.), Which gives the value (value) for them (Kotler, 2011). Pleasant experience (the beautiful natural scenery, quiet, calm and even romantic, performances or great attraction, even thrilling (activities - rafting, hiking, outbound, flying fox, etc., or other activity that triggers adrenaline), comfortable accommodation and food tasty, good performances especially thrilling, is the offers that are considered to have value in the eyes of consumers so as to encourage them to visit places that offer these things. In short, the exchange between consumers and producers is triggered by value in the eyes of their respective respectively.

Whatever the tourists do and experience and what they are looking for is changing over time, vary from one country to another, and between categories of social class, gender, and race. Variations of what is sought by the tourists described by the experts, one of whom MacCannel (1976) which argues that one traces the beginning of a series of activities that tourism is the value system of the modern world. By placing the tourists as the subject peneltiannya, penelitian MacCannel aimed to explore the "ethnography of modern society". According MacCannel, modernity is characterized by feelings of isolation, fragmentation, and superficiality. Search of authentic experiences is refleksi

modern tourist desire to reconnect with the "pristine (the value of which is still pure / genuine), primitive, natural, untouched even modernity" (Cohen, 1988, p. 374).

Now there are efforts to raise tourism participatory and involve the local population as the decision makers. However, it should be criticized that this involvement is deemed insufficient to secure the benefits of tourism for the locals. In other words, tourism in one place (village) must also pay attention to efforts to maintain such conditions as local political structures and economic institutions, the relationship between ethnicity, gender stereotypes, and the obligation to give employment to the local population or known as a community-based tourism or ecotourism.

Ecotourism was developed with the hope of contributing economic impact on local residents to maintain and protect the natural environment and traditional culture is the reason for tourists to visit. However, regrettably, there is a lack of effort to evaluate the impact of ecotourism incentives for tourists' perspectives and behaviors associated with them. The goal of ecotourism is to raise their awareness about the environment and culture. It is unknown how the trip (a visit to a tourist location) to raise awareness and educate people to be aware of the environment and culture. Which is already widely known is the feeling of tourists about accommodation yet unknown is a change of mind, feelings, or behavior of the tourists, as a result of anything that they see on sites they visit. More fundamental is whether the values of the tourists changed or not. Ideally, ecotourism, which offers a different travel experience would give a distinct impression. So, tourism and recreation can also be associated with learning.

### **c. Sharia Travel and Sharia Village Tourism**

Travel sharia is one part of the tourism. Travel sharia understood as products of tourism that provides hospitality services that meet the requirements syar'i (Ramli, 2011). In this case, Muslim travelers will be served without leaving their syariah needs. During this time, travelers do not know the word sharia. Many have traveled forced to fulfill some obligations sharia haltingly because of the unavailability of accommodation such as a place of prayer, guaranteed halal food and attractions that are free immoral. With the sharia is expected to travel the tourists do not have to worry about the pilgrimage sharia.

Sharia accommodation requires six things that need attention.

- 1) Food and beverages must meet halal standards.
- 2) It must provide a place for praying five times a day or at least three times daily prayers.
- 3) For the cleaning of waste water (istinjaa') preferably use water rather than tissue.
- 4) The need for separation of men and women for swimming and gymnastic activities.
- 5) The provision of accommodation which meets the criteria of sharia.
- 6) The provision of convenient payment system but remains within the corridors of sharia.

Foods that meet Halal standards should prohibit the use of any substance that contains pork . So too , the food containing the substance in question should not have served halal status . To drink kosher is free of alcohol and a few drinks that do not contain alcohol but are considered unclean because of the intoxicating effect or produce hallucinations .

Praying is a primary obligation for Muslims. Provision of prayer accompanied wudlu place and should be prioritized clean and comfortable. Each tour schedule must take into consideration the time of prayer. As well as any tourist attraction can be there if the mosque or the mosque.

In *istinjaa* , Muslims prioritize the use of water, not tissue. The use of tissue or other material is allowed only permitted when water is not available. Also for urinal for men is necessary to provide a special tool that serves as a barrier to splashes of urine (Djazuli, 2006) ..

The separation of men and women is strictly for Muslims. For activities that are most often show genitalia for women is swimming, gimanstik, and spa. Therefore, for this activity, it is advisable to do the separation between men and women.

Lodging must meet the criteria of sharia. Minimal amenities of the inn sharia is the Qibla directions. However, if indeed declare as sharia lodging must have additional services such as providing food and drink only kosher berkriteria, provides a special pool of women, the mosque, and security to the guests and the Koran in the room where a break. Furthermore, it should have a special check-in procedures in which couples who stay must have proof as husband and wife. In addition, if there are performances (entertainment) should show for all ages.

Method of payment also require modifications to fit the sharia. In sharia is not allowed interest rate or profit. Many ways of payment allowed under sharia, such as Islamic credit card or money transfer via ATM or debit cards issued by Islamic financial institutions are known. Therefore, the vendors should begin to adjust to the practice of sharia.

The sixth thing, which needs to be done in an integrated manner, is a minimum requirement of sharia travel. Other conditions not far from the sixth it, but deepened as for food must be halal and thoyyib. As for the hotel to be coupled with waking comfort, safety and cleanliness.

Sharia tourism products that can be offered is very broad. Traditional tourism services can also serve travel sharia. This includes nature, culture, and culinary. Basically sharia tour is no different from conventional travel, only a few additional accommodation and facilities intended to make Muslims become comfortable in visiting tourist attractions and accommodation, even when traveling to foreign countries.

Similarly, sharia tourist village which does not differ much with conventional tourist village. There are some accommodation must comply with sharia, such as food, lodging, transportation, and places of worship. With more stringent provisions would be more difficult to manage the tourist village of sharia. However, with the strict provisions of *berkonsekwensi* accommodation with quality accommodation and culinary better

which in turn would benefit the guests who use sharia travel from both Muslims and non-Muslims.

### 3. Tourism Village in the district of Sleman

Sleman district is a district that has many tourist villages. This district has the potential to build a tourist village as a great natural potential. Mount Merapi as one of the most active volcanoes in Indonesia, and the environment which includes forests, rivers, and various typical plants such as pondoh is potential in this district. If the environmental characteristics of a tourist village - tourism village in this district are equipped with the means to play (outbound), tracking, culinary, and coupled with a variety of cultural and historical heritage, the village will become a tourist attraction is strong tensile power.

Tourist village located in Sleman be one alternative attractive tourist destination. In the tourist village visitors will get freshness and comfort typical of a rural community with a traditional life of Java. Nonetheless, each tourist village offers a uniqueness of its own. There were six uniqueness offered by the tourist villages. These include uniqueness nature / environment, cultural tourism, sightseeing craft, agro tourism, religious tourism, and tourism with special interest. Nature tourism offers scenic beauty around the tourist village. Cultural tourism is intended to provide an introduction to Javanese culture in rural areas. Tourism crafts are introducing unique products crafts people of Yogyakarta to the tourists, agro tourism offer unique plants such as bark Pondoh Sleman, religious tour featuring rural life and religious activities, and tours with special interests such as the batik course, *nembang* (sing javanese song), or the Java. dance

Tourist village in Sleman according to the records department of tourism amounted to 32 rural districts , but only 12 villages that are considered active . Of the twelve tourist village there are ten villages that are very active , namely Grogol , Sidoakur , Jethak II , Gamplong , Sukunan , Flower Arum , Nganggring , Ledok Nongko , Brajan , Plempoh , Pulesari , Kampung Batik , stumps Arum , Brayut , Kadisobo II , Tanjung , Important Sari .

Most of the tourist village in Sleman district is managed by professional enough . The manager of the tourist village using modern management such as marketing management , human resources , products , or financial . Also the awareness of managers to set high standards of cleanliness because they believed that the tourists prefer it if the condition tourist village in a clean state .

### 4. Research Methodology

Tourist village located in the district of Sleman has the potential to be a tourist village sharia. This great potential would be meaningless if all stakeholders do not have the interest to try the tourist village of sharia. To determine the potential and the will transform themselves into tourist village of sharia will be conducted research in which data are required and collected through several techniques as follows.

- a. Participant observation, the researchers seek to participate directly in and while observing the various activities in the tourist villages

- b. Documentation, that data taken from documentation in the form of thesis, dissertations, newspapers, internet, and other documented materials that are relevant to this study.
- c. The interview, conducted to get clear of the things that contain exceptions, deviations, the interpretation of which is less prevalent, the need for reinterpretation, a new approach, the expert view, or even a single perspective. This kind of data taken from the respondents selected for reasons of mastery of knowledge and the situation above average, so that the data obtained in accordance with the expectations of researchers. Interviews were conducted to those who are in the management structure, Sleman District Government, community leaders (village head, RW / RT), and some tourist village communities randomly selected.

Of the board are expected to obtain the data potential tourist village that will benefit the local community. Of the government in this case the Ministry of Tourism Sleman expected to obtain data regarding the role and government support for the development of the tourism sector, in this case the tourist village (sharia) as an effort to improve the standard of life of local villagers. The village head, RW / RT is expected to provide data on the role of rural tourism development of the tourist village community life. While the public expected data on anything they have earned from tourist village in which they participate. In other words, the data from the public on the benefits expected to be obtained confirmation of a tourist village that has dikemngkan by local governments, village governments, and society itself.

- a. A list of questions. The list of questions is given both to the managers, stakeholders (village heads, heads of RT / RW, rural communities, and the Government of Sleman), also to the tourists who at the time of distribution of the questionnaire is in the location studied. Answers from each respondent is expected to obtain an objective picture of the progress and benefits of the tourist village for residents and visitors as well as an overview of the potential tourist village which is now to be converted into a tourist village sharia.
- b. Sampling method  
Given the number of tourist village in Sleman district is 32 villages and the district government of Sleman informed only 12 active tourist village, the whole village tourism made the object of research. All tourist village attended for examination. Thus, this study uses population data.
- c. Analysis Method  
There are three tools that will be used to determine the potential and readiness of Sleman in the tourist village of sharia. First, perform data collection was a questionnaire whose content is to determine the readiness of the stakeholders to offer the tourist village of sharia products. Second, conduct a SWOT analysis (strengths, weaknesses, opportunities, and threats) to determine the potential of Sleman district in organizing tourist village of sharia. SWOT analysis is used to identify a number of systematic factors (both internal in this case strengths and weaknesses of the tourist village management institutions,

as well as external threats and opportunities that exist) to formulate a rural tourism development strategy. SWOT analysis is based on the logic that maximizes strength (Strength), and Opportunities (Opportunities). But at the same time to minimize the weaknesses (weaknessess) and threats (Threats) (Kearns, 1992). Results of the SWOT analysis will be used as the basis for a proposal for a strategic plan to develop tourism village in general and specifically the tourist village sharia. Third, perform cluster analysis in order to construct the model tourism village sharia according to the situation Sleman district. Data for cluster analysis using secondary data is owned by the local government of Sleman district.

## **5. Discussion**

In visiting tourist village to conduct research that not all tourist village is willing to be interviewed. Many of them are not easy to find location. If already at the scene, sometimes people in the village do not even know if the village has become a tourist village so they are difficult to tell who travel village board. The next information reveals that residents often see the foreigners who live temporarily in the village. They suspect that there are people who organize tourist villages but residents do not feel the tourist village. This indicates that many tourist village are managed by a hit-and-run or if there is an order only. With such constraints it found 19 tourist villages that are active so that the tourist village Nineteenth be the object of research. It is larger than previously forecast a gain of just 12 active tourist village.

The technique used to obtain information from 158 people as the respondent is a direct interview. They are happy to provide information on what is asked of them. Basically they do not mind their village into a tourist village and are likely eager to assist the management of the tourist village. They acknowledged that the tourist village does not necessarily increase the prosperity of society. But recognized also that the opportunities increase revenue from the tourist village pretty wide open. The respondents saw the potential to increase the prosperity of the citizens of the existence of this tourist village though it is still not felt yet.

In terms of facilities provided by the tourist village in serving the tourists there are still many obstacles that occur in the field. Starting from the scarcity of parking space for tourists, providing a decent restaurant, tourist facilities were clean, the toilet seat up in the absence of an obstacle in Melyani tourists who will enjoy the village as a tourist destination. This suggests that both managers and villagers do not know how to cater to tourists are correct. From the interview seemed beliefs of citizens and managers who are proud of the unique facility is the excess of the rustic villages that are "rustic" is. However, they often overlook other important factors such as comfort, cleanliness, and international culture that should exist in every tourist village facilities. To "rustic" an be proud of is not wrapped with comfort and cleanliness. Problems lack sufficient protection from mosquitoes by managers is considered as part of the attraction. Whereas for tourists it is important for protection from mosquitoes is provided. Also on the issue of cleanliness of the toilet becomes a fairly important obstacle. Moreover, no provision of the toilet seat may cause the value of the tourist

village down in the eyes of the tourists who mainly have a background in the city where the vehicle defecation is something that can not be negotiable.

Management of villages tourism are still modest also not thinking about how to do promotion to prospective tourists. Most rely on the campaign carried out by the Government of Sleman and Yogyakarta. The manager has not thought about promotion through the internet where the scope is wider. Because the campaign is relying on help from the district and provincial governments are not involved on the side of the tourist village producing services, recognized that among the promoted with what nature tourists are often different. Surely, if this is allowed will harm the tourist village itself. Should have begun managing their own promotion so as to adjust the fit between the promoted and provided.

Until now, a tourist village in Sleman district has no certain form of sharia tourist village. When respondents were asked about willingness to change the status of conventional tourist village into a tourist village sharia, on the average, respondents are optimistic can offer tourist village sharia well. At least in terms of food and beverages have been guaranteed halal. However, there are doubts if asked about the willingness and readiness to offer sharia tourist village after it was explained about the image of a tourist village sharia. They are still unfamiliar to arrange accommodations in accordance with the provisions of sharia. They also are still blind to the potential tourists travel-oriented world of sharia. Which is difficult to convince them is that products and services will not change the total travel if implemented based on Islamic principles. Seems to need a serious effort to them to convince the great potential existing Islamic tourist village in sight. If you already are convinced, would be easy to change the shape of a tourist village services than they are now becoming more friendly sharia travel.

From various information collected in the field have been prepared a SWOT analysis of the tourist village in Sleman district . SWOT analysis can be seen in Table 1. From this analysis it appears that issues dominate internal factors than external factors . This shows improvement and utilization of space wider than the internal side than on the external side .

**TABLE 1. SWOT ANALYSIS**

INTERNAL FACTORS	EXTERNAL FACTORS
<b>Strengths (S)</b>	<b>Opportunities (O)</b>
<ul style="list-style-type: none"> <li>a) The development of village tourism is supported by the high participation</li> <li>b ) The village is relatively wide , has the potential of abundant resources to allow for the addition of attractions and travel packages</li> <li>c ) Life and livelihood in the tourist village is based on the traditional rural culture is still strong</li> <li>d ) Has the infrastructure and facilities are adequate</li> </ul>	<ul style="list-style-type: none"> <li>a) There has been a Tourism Village development agreement with relevant stakeholders .</li> <li>b ) The interest of tourists to visit the Village Tourism grows year by year</li> <li>c ) Regionally close to the main street of Yogyakarta - Magelang</li> <li>d ) Availability of infrastructure ( roads and TI ) which facilitate access to the tourist village</li> <li>e ) Promotion is still separate from the overall promotion of tourism DIY , as well as promotion through virtual media</li> </ul>

	<ul style="list-style-type: none"> <li>f ) The possibility of becoming a travel package with conventional DIY</li> <li>g ) The diversity of crafts and arts</li> </ul>
<b>Weaknesses (W)</b>	<b>Threats (T)</b>
<ul style="list-style-type: none"> <li>a) Does not yet have the readiness to protect visitors from the eruption of Mount Merapi</li> <li>b ) Promotion is done passively</li> <li>c ) Lack of human resource skills and insights tourist village communities about good service standards</li> <li>d ) Lack of capital for development of rural tourism</li> </ul>	<ul style="list-style-type: none"> <li>a) The eruption of Mount Merapi . Most tourist village located in the danger zone ( located about 15 km from the peak of Merapi )</li> <li>b ) Effect of foreign cultures (visitors ) to the cultural purity of the tourist village residents</li> <li>c ) The more rapid growth of the tourist village ( both conventional and sharia ) in various countries</li> </ul>

From the SWOT analysis it is indicated that there are problems both in external and external sides. Weakness promotion programs, investments for development of rural tourism and human resources is an inherent problem, faced by all tourist village. External problems include a lack of serious support from relevant parties such as the maintenance and development of infrastructure, facilities and infrastructure damaged because it was too long is not repaired. If the support was given, the manager, has been reduced at least one of the principal problems of tourism, namely the ease and convenience of access, to then be more focused on the improvements of the existing kekurangan.

What is revealed from the facts on the ground is the presence of at least three pressure to a tourist village that substitution pressures, the buyer (tourists), as well as internal competition. Sleman regency tourism is not only a tourist village but also conventional tourism thrive in advance. Conventional tourism seems to be more in demand by tourists because it has been done a long time so it is difficult for a tourist village to compete. Because the tourist accustomed to conventional tourism, tourist villages become unattractive if there is no value that can be offered. This is compounded by a weak campaign for being too passive. These pressures exacerbated by the internal competition in which the actors in rural tourism industry is likely to provide a uniform product and does not provide a unique product for each tourist village. Different things happen in Taiwan where a tourist village offers a unique thing which became the main attraction (Liu, 2010).

Incapacity managers in offering unique products typical tourist village and villagers understanding of the products needs and desires of tourists cause variations in the tourism product offer tourist village is still stagnant . It is necessary for the correct development strategy in order to become more competitive tourist village on the products of other travel outside the tourist village . In Table 2 are given alternative strategic direction how a tourist village can be developed . Of course this does not only involve managers and villagers related , but also local governments and stakeholders are also concerned about the welfare of the community .



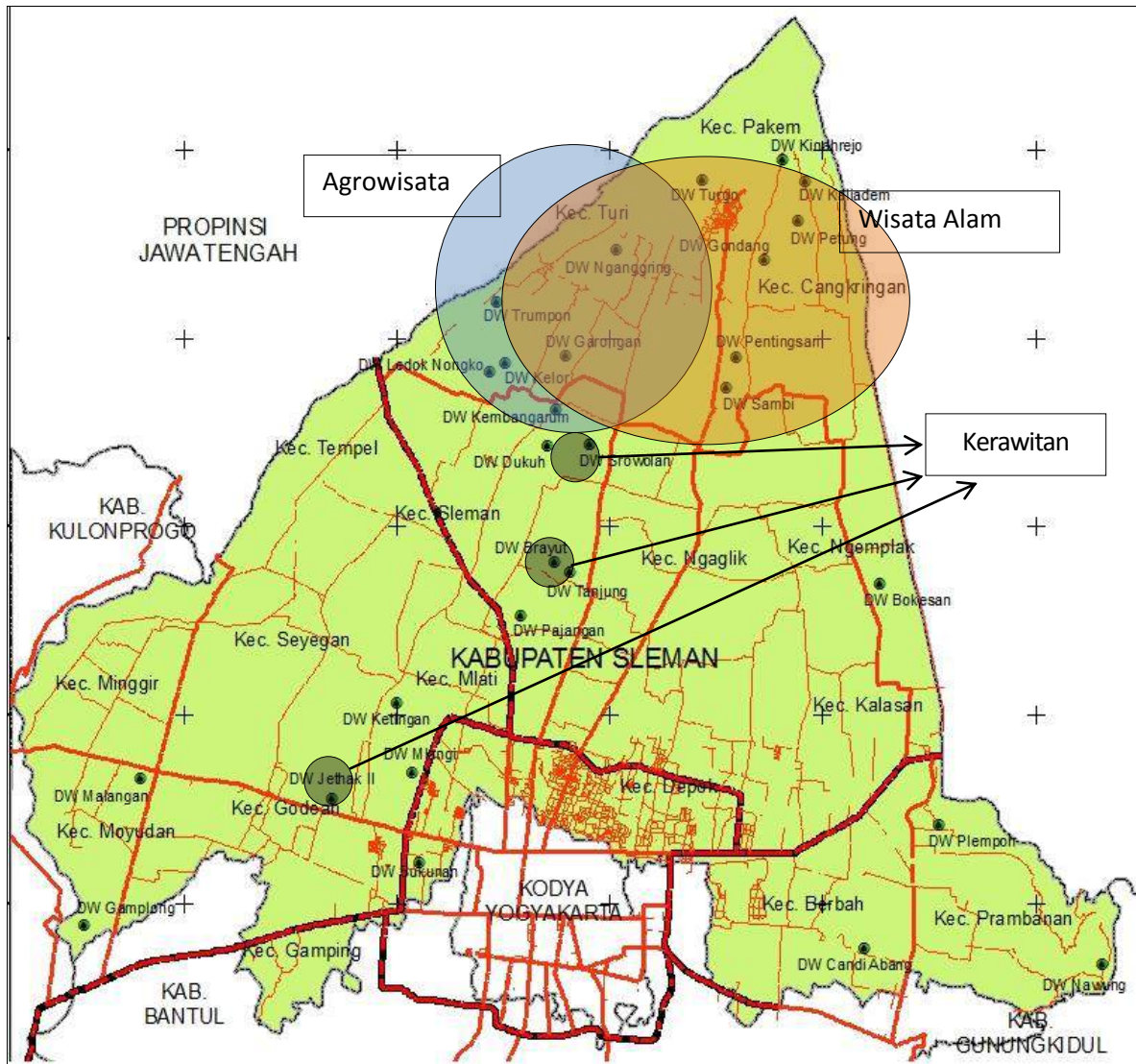
**Table 2. Strategic Referral**

<b>Referral Strategy Development of S + O</b>	<b>Referral Strategy Development of W + O</b>
<p>a. Maintain the spirit of community participation , improve cooperation between the manager of a tourist village with the relevant stakeholders .</p> <p>b .Optimization of the potential of natural , social and cultural interest of the community to respond to a visit or increase the frequency of visits to tourist village .</p> <p>c . Encourage the creation of a diversity of crafts and arts to attract new segments ( young people , for example) so want to visit tourist village</p> <p>d . Brings together village tourism in the promotion and tourism programs in the overall DIY</p>	<p>a. Realization of cooperation between the manager of a tourist village with stakeholder both public and private investment in order to improve the promotion and tourist villages .</p> <p>b . Improving the quality of human resource skills and insight into the local community as a basis for improving the quality of service to tourists .</p> <p>c . Making village tourism as a tourist attraction in DIY unity in promotion</p> <p>d . Investments for the improvement of facilities and infrastructure in the tourist village</p> <p>e . Training to improve the ability to create the diversity of tourism products and arts crafts DIY as well as knowledge of the tourism service standards .</p>
<b>Referral Strategy Development of S + T</b>	<b>Referrals Development Strategy of O + T</b>
<p>a. Maintain , and even reinforce the pure culture / travel through the maintenance of the original village traditions, ways of life and livelihood .</p> <p>b . Highlighting characteristics and improve competitiveness by optimizing the potential of natural and proactive role of the tourist village communities as the basis of innovation and / or a variety of attractions in order to increase tourist visits .</p> <p>c . Creating a perception of safety and comfort while in tourist villages along with improved quality of existing infrastructure</p>	<p>a. Optimization of the cooperation between the managers of each tourist village with stakeholder ( government and private ) investment in improving the promotion and tourist villages .</p> <p>b . Develop quality human resources community around each tourist village as a base of quality service to the tourists .</p>

From this it appears that the strategic direction of cooperation with various parties is absolutely necessary to develop a tourist village . The same thing should be done when the tourist village communities and managers to change the orientation of the orientation of the product to consumers . With the assistance of a number of parties , tourist village communities must begin to change the mindset , that the tourist village built and offered to meet or satisfy the needs of consumers and not meet the wishes of the manager or the seller . This orientation is very fundamental change because it would make the manager take seriously anything that become needs and keinginan visitors . Furthermore, it will make the service pack is packed with tourist villages to meet the standards that consumers want , such as the rural environment should be clean , safe , comfortable ; toilet does not smell of urine ; food served with a neat , clean and attractive ; bedroom neat though composed of simple furniture ; etc.

For the cluster analysis will use the map as an analytical tool. It is necessary to provide a comprehensive picture of the uniqueness of the products that can be offered by the tourist village. Based on data from the Tourism Office of Sleman District Government, of 32 tourist villages, tourist villages there are 18 or more than 50% of the tourist village in Sleman district is located on the slopes of Mount Merapi. While in the northwest there are five tourist village. The rest is spread in central and eastern Sleman (see figure 2). From these images appear clear their agglomeration tourist villages around the slopes of Mount Merapi. Of products offered there seems to be uniformity to the tourist village on the slopes of Merapi namely agro pondoh and natural beauty of Mount Merapi. From Figure 2 also appears that occurred the same concentration of products to the tourist village west slopes of Merapi. Other variations appear as the outbound travel of cattle, and cruising Merapi lava. As for other travel outside the village slopes of Merapi are studying musical products in three tourist villages studied were in the village Brayut, Srowolan village, and the village Jethak II. The rest of the other tourist village is still not clearly define its products. The most common of the rest of the tourist village is a cultural product and Javanese village life.

**Figure 1. The Map of Sleman District Area**



From these explanations have occurred naturally agglomeration tourist village in Sleman district. Agglomeration tourist village located around the slopes of Mount Merapi has advantages and disadvantages. There are three advantages of the existence of the agglomeration. The first is make it easier for tourists to find a vacation in a tourist village. The second is easier for the managers of the tourist village to cooperate with each other in the tourist village. The third is easier for local governments to streamline the provision of public facilities in the surrounding area. Two flaws with the agglomeration is easy jam occurs and the competition becomes very hard. Therefore, to prevent it all, infrastructure such as roads leading to tourist village which is well worth a need to be prepared so that access to the site becomes easy and convenient. Very easy to understand if the management of the tourist village will not run properly without the cooperation of one another. Therefore, it should be driven by the stakeholders to change the feel of competition in the tourist village become competitive spirit of

cooperation (coopetition) trigger source of creativity and uniqueness of creation kewisataan bid. Suppose offer agrotourism not pondoh namely strawberries or other fruiting season is not affected and the public interest. Other than that, the creation of a sense of security from the danger of Merapi eruption also needs to be done through good communication, for example by notifying evacuation programs and shelters are safe and comfortable when there is danger of Merapi eruption threatens. Feel safe and comfortable in a very important tourist spot for tourists.

Agglomeration in the northern area of Sleman district provides opportunities for village tourism in other areas to develop other unique products. A unique one in the southern area of Sleman district are students in village life and education in the village Mlangi Sukunan. For other tourist villages yet to develop a unique product that is able to attract the attention of tourists. For example, a tourist village has a unique Ketingan Blekok where birds often rest on a large pool of the village. Unfortunately, this unique case is not managed properly. While in Jethak II, Tanjung, and Srowolan communities and local government can develop *kerawitan* art, eg popular songs even western songs accompanied by gamelan that will attract tourists and impress the young and from abroad. The role of local government is also required in the promotion and encouragement of tourist visits to the centers kerawitan through uniting efforts for these villages into promotional packages and program / conventional travel packages DIY whole province.

## 6. Conclusions and Recommendations

### a. Conclusion

1. From the SWOT analysis can be concluded that:

- 1) The potential of the tourist village in Sleman regency large, but still faces a number of obstacles such as: skills and lack of insight into the service with a good standard, passive promotion, offer limited variety and creativity in the field of crafts and arts. In addition, alienated from the general tourism in the province, due to the limited awareness of rural communities broadly about potential tourist village.
- 2) Alternatives generated strategies to address constraints in the development of rural tourism. The important thing to note by all stakeholders is the need for the realization of a number of strategies to develop tourism activities in the tourist village. But most important is the development of human resources, both managers and workers so that they will be able to create products that offer unique and interesting.

2. From the cluster analysis can be concluded that:

- 1) Cluster analysis revealed two main groups location of a tourist village, which is located around the slopes of Merapi and off the slopes of Merapi are scattered. More than 50% of the tourist village of Sleman district are close together on the slopes of Merapi. While the rest are scattered in the lowlands this district.
- 2) tourist village located on the first group have similar characteristics of the product offer, namely agro-tourism and nature. While the tourist village

on the second group has a diverse product characteristics and individual offer.

3. In general , all the existing tourism offer of the product has not been managed well . Similarly, other such potential cooperation with stakeholders and the promotion and cooperation with provincial tourism DIY as a whole .
4. Apply the tourist village of sharia in the conventional tourist village will not change the product characteristics of each village because sharia travel did not ask to change the characteristics of the product unless that is contrary to Islamic values .
5. Thus, whatever the model of development of the conventional tourist village will be applicable to the tourist village of sharia .
6. However, people from various stakeholders showed a lack of willingness to switch from conventional tourist village into a tourist village sharia . This is due to lack of knowledge about the potential of the tourist village islamic world and still less familiar perception of the concept and implementation of the travel or Islamic principles broadly .

#### b. Recommendation

1. Given that all tourist village have such problems, for the purposes of effectiveness and efficiency, priority needs to be developed rural tourism development. For example, priority based on the ownership of a double potential (agro-tourism and nature). Or a tourist village has only one potential but has a high appeal and easy to develop. Or also by geographically adjacent to each other and have similar product characteristics bid.
2. Based on the results of cluster analysis which indicates the presence of two major groups, based on the location and characteristics of the product, then the model of rural tourism development in the district. Sleman focused on two main points, namely:
  - 1) The model for the development of tourist villages are located near the slopes of Merapi, which insists on agrotourism and nature. They were given training and motivation so that it has the ability to compete with based on the spirit of co-opetition, and
  - 2) The model for the development of tourist villages located in lowland district. Sleman focused on the development of the uniqueness of the high selling power to the tourist market. For example in Srowolan developed kerawitan classic and creative arts.
3. In connection with the application of sharia tourist village, the conventional model of rural tourism development can be applied to the tourist village of sharia without any significant change. This is because it is basically a tourist village sharia does not require changing tourist products that exist throughout the follow values in Islam. Development of rural tourism will face two struggles sharia similar to conventional tourist village is focusing on agro products and its natural attractions that are located on the slopes of Mount Merapi, and

develop unique products of high selling power to travel outside the village slopes of Merapi.

## References

- Anonym (2010) , "Rencana Strategis Satuan Kerja Perangkat Daerah Dinas Kebudayaan dan Pariwisata Kabupaten Sleman Tahun 2011-2015".
- Besanko D, D Dranove, M Shanley, S Schaefer, (2013), *Economics of Strategy*, 6th ed., John Wiley and Sons.
- Cohen E., (1988), "Authenticity and Commoditization in Tourism", *Ann. Tour. Res.* 15:371-86
- Crescent Tours, (2013), *World leader in Halal Holidays*, diunduh dari <http://www.9thwief.org/CMSPages/GetFile.aspx?guid=921f377e-25f0-4f13-b932-8b40565fe8da>
- Dwyer, L., and Spurr, R. (2012), *Tourism Economic Summary*. Diunduh dari [www.crctourism.com.au/wms/upload/resources/Tourism%20Economics%20Summary%20WEB.pdf](http://www.crctourism.com.au/wms/upload/resources/Tourism%20Economics%20Summary%20WEB.pdf)
- Djazuli, A., (2006), *Kaidah-Kaidah Hukum Islam dalam Menyelesaikan Masalah-Masalah yang Praktis*, Deltabuku Press.
- Henry, A, (2011), *Understanding Strategic Management*, Oxford University Press.
- Kevin P. Kearns (Fall 1992) "From Comparative Advantage to Damage Control: Clarifying Strategic Issues Using SWOT Analysis," *Nonprofit Management and Leadership*, vol. 3, No. 1. New York: Henry HoltUniversity.
- Kotler, Philip, (2000), *Marketing Management*, Prentice Hall International Inc. The Millennium Edition.
- Liu, CZ, (2010), "Rural Development and Rural Tourism in Taiwan", *Asian Journal of Arts and Sciences*, vol. 1 no. 2, pp 211-227.
- MacCannell D.,(1976), *The Tourist: A New Theory of the Leisure Class*, Shocken Books.
- Orams, M. B., (1995). "Towards a more desirable form of ecotourism", *Tourism Management*, vol.16(1), 3-8.
- Pearce PL, (1982), *The Social Psychology of Tourist Behavior*, Pergamon Press.
- Porter, M., (1979), "How Competitive Forces Shape Strategy", *Harvard Business Review*, Vol. 57(2), 137-145.
- Porter, M., (2008), *Competitive Advantage: Creating and Sustaining Superior Performance*, Simon and Schuster.
- Ramli, N., (2011), "Halal Tourism: the Untapped Market for the Halal Industry and Its Services", paper yang dipresentasikan pada Halal Tourism, Kuwait, [irep.iium.edu.my/.../HALAL\\_TOURISM-KUWAI](http://irep.iium.edu.my/.../HALAL_TOURISM-KUWAI)., dilihat tanggal 20 Mei 2013
- Roth, H. and M. Fishbin, (2015), *Global Hospitality Inside*, taken June 20, 2015 from [http://www.ey.com/Publication/vwLUAssets/ey-global-hospitality-insights-2015/\\$FILE/ey-global-hospitality-insights-2015.pdf](http://www.ey.com/Publication/vwLUAssets/ey-global-hospitality-insights-2015/$FILE/ey-global-hospitality-insights-2015.pdf)

- Sarker, MAR, GH Chowdhury, L Zaman, 2012, "Sustainability and Growth of Low Cost Airlines: An Industry Analysis in Global Perspective", *American Journal of Business and Management*, Vol. 1. no 3, pp 162-171.
- Smith V, ed., (1989), *Hosts and Guests: The Anthropology of Tourism*, Philadelphia: Univ. Penn.
- Stein, H, (2010), "Literature Overview on The Field of Coopetition", *Business: Theory and Practice*, Vol. XI,no. 3, pp. 256-265.
- Stynes D, (1999), "Economic Impacts of Tourism". <https://www.msu.edu/course/prr/840/econimpact/pdf/ecimpvol1.pdf>
- Vanhove, N, (2011), *The Economics of Tourism Destinations*, 2<sup>nd</sup> ed. Elsevier.
- Wang, Y., & Krakover, S., (2008), "Destination Marketing: Competition, Cooperation or Coopetition?", *International Journal of Contemporary Hospitality Management*, 20(2), pp. 126 -141.
- World Economic Forum, (2013), *The Travel & Tourism Competitiveness Report 2013: Reducing Barriers to Economic Growth and Job Creation*, taken from [http://www3.weforum.org/docs/WEF\\_TT\\_Competitiveness\\_Report\\_2013.pdf](http://www3.weforum.org/docs/WEF_TT_Competitiveness_Report_2013.pdf) on June 20, 2015.
- World Travel and Tourism Council, (2014), "Travel and Tourism: Economic Impact 2014", taken from <http://www.wttc.org/-media/files/reports/economic%20impact%20research/regional%20reports/world2014.pdf>, June 20, 2015.
- Zeithaml, VA and MJ Bitner,(2002), *Services Marketing*, McGraw Hill.

# **SOCIAL SCIENCE CHAPTER**



## Cadar And Identity : Phenomenological Studies Of Women Perspectives

Lintang Ratri Rahmiaji MSi

Faculty Of Social and Political Science, Diponegoro University,  
[lintang\\_adjidarein@yahoo.com](mailto:lintang_adjidarein@yahoo.com), 08883919778

### Abstract

Women have struggling for long time to their existance against men. Many problems derivated from gender concepts, how women create their knowledge, values, and perspective about themselves and the world. Women, in many studies, always caught in the subordinate role with or without awareness. Veil is a new problem, although Indonesia one of the largest moslem country, acceptance of the veil requires a long process. *Cadar* is the next step in the use of the veil. The problem is, *Cadar* often associated with the attributes of a fanatical Islamic organization, fundamentals and hardliners. It is more strongly attached when the media coverage of new label for women whose wearing *cadar*, is the wife of terrorists.

By using the phenomenology method, this study answers the fundamental question of identity presented by Robin RM Coleman, its explained who we are, who we are in relationship to other, how identity is formed, how who we are is negotiated within varying contexts; and how our identities can lead to resistance and solidarity. Based on the results of the study found the *cadar* women tend to identify themselves as a wife, mother, and not herself. The *cadar* women tend to limit their contact with the world, including restrictions on media exposure. The decision to use the *cadar* was not significantly influenced by age, and academic education, but depend on opened access to study Islam intensively and access to the *cadar* women community. For them, *cadar* is *takwa* clothes, its better, because they think whole women body is *aurat*. The *cadar* women live like others normally, however, with *cadar*, they has their own exclusive social norms to perform.

**Keywords:** *Cadar, Identity, Women Studies, Cultural Communication, Islamic Feminism Studies*

### A. INTRODUCTION : Women, Cadar, and Identity

People constantly contemplate about their identity, about self. Identity is a self-reflective as understood by people in the context of his biography. Stories of identity seeks to answer some critical questions of what to do, how to act and to whom we want to become. Individuals trying to construct a coherent narrative identity which themselves form a developmental trajectory from the past to the future can be predicted.<sup>1</sup> Identity was both personal and social. Identity become the linkage of similarity. On the one hand, identity differ individual from others. It is understandable through the forms of representation.<sup>2</sup>

The fundamental question of identity is "who am i?" Coleman said, research on identity has been highly developed which then led to the concepts presented as follows,<sup>3</sup> 1. *who we are*, 2. *who we are in relationship to other*, 3. *how identity is formed and maintained*, 4. *how who we are is negotiated within varying contexts; and how our identities can lead to struggle, resistance and solidarity*.

He further stated that the identity is influenced and constructed by the institutions of family, school, government, law, religion, language / communication, and media. So in other words it can be said that the construction of identity is the result of interactions, relationships and influences between individuals with the institution. Identity is formed by social processes and it is a phenomenon that arises from the dialectic between individuals and society as expressed by Berger.<sup>4</sup> More or less the same definition expressed by Liliweri in communication perspective emphasize that the nature of the interaction of self / group is something that is communicative.<sup>5</sup> Furthermore, he added that "identity is

<sup>1</sup> A. Giddens. *Modernity and Self Identity*. Polity Press : Cambridge, 1991, p.53-75

<sup>2</sup> Chris Barker. *Cultural Studies: teori dan praktek*. Kreasi Wacana : Yogyakarta, 2008; 220

<sup>3</sup> Robin R. Menas Coleman. *Say it Loud!: African American Audiences, Media, and Identity*. Routledge: London, 2002, p.4

<sup>4</sup> Peter L. Berger dan Thomas Luckmann. *Tafsir Sosial Atas Kenyataan*. LP3ES, Jakarta, 1990, h.247

<sup>5</sup> Liliweri, Alo. Prasangka dan Konflik : Komunikasi Lintas Budaya Masyarakat Multikultur. LKIS: Yogyakarta, 2002, h.78

built through social interaction and communication. Identity generated by negotiating through the media, the language".

Women have long to dwell on the problems faced by the social position of men. Many problems are present derivative of gender concepts, especially the fundamental is the concept of knowledge, values, and women perspective about themselves and the world. Women, in many studies, always caught in the subordinate role with or without awareness. Female self-concept are the properties attributable to the self as a woman, which encourage and also inhibit their behavior. This self-concept development was influenced by other people's feedback and personal experiences. Women's self concept is not something given, but a learning process. Women's self concept is the result of the interaction between women nature and nurture.<sup>6</sup> The existence of women is justification of cultural colonialism lifetime by patriarchal capitalism. Women seemed destined to be colonized, marginalized and discriminated, simply because she was a woman.

History has held so many records of discrimination veil in various corners of the world. Especially in the West, the veil seems to be a terrible monster who should be cast out of the social, cultural, or political. So no wonder, restriction and prohibition of the veil is poured into the realm of state legislation. On the premise Geert Wilders, a right-wing MPs in the Netherlands, regulations ban the *burqa* in all regions of the Netherlands adopted in December 2006. Starting in June 2006, a ban on the wearing of veil widespread in Germany. 8 out of 16 states in the country imposed a ban on veil in public schools Germany. Wear a veil ban also applies in the countries Sweden, Belgium and Spain. Moreover, the Catholic Church Spain supports the ban on veil in public places. They claimed that the headscarf is a symbol of oppression of women. Whereas Spain has recognized Islam under the laws of freedom in July 1967.<sup>7</sup>

In fact, the prohibition against glorifying the Moslem fashion is not only occur in countries of West alone. Republic of Tunisia, a Moslem Arab country located in North Africa, precisely on the Mediterranean coast has a long history in discrediting the veil. In the process, in 2006, the Tunisian government not only prohibits female students and female students wearing veil in school and in college, but also 'mengsayamkan veiled women entered and hospitalized country, prohibits pregnant mothers giving birth in hospital state because veiled, even in September 2006, the Tunisian government held a security operation by rummaging through various shops in which sell veiled dolls.<sup>8</sup> President of Turki, Ahmed Necdet Sezer issued a decree banning the wearing of veil in state institutions, schools and universities since 1997. There are veiled reporters whose not allowed to cover a press conference in Lambaga government agencies. Still in the same month, in line with John Sentanu, Egyptian Culture Minister Farouq Hosin, remarks that the veil of Moslem women as a form of deterioration. Farouq claim that Islam never require hijab for moslem women.<sup>9</sup>

Feminist with western ideology have dominated the discourse of veil, they identified veil as patriarchal aspect and claimed as a sign of backwardness, subordination, and the oppression of women.<sup>10</sup> This unidimensional approach narrowed study of the veil into a single contextual analysis and cause distortion in view of the actual complex cultural phenomenon.

Snouck Hurgronje once wrote an article entitled "The veil for Women," published by the French-language journal *Revue Scientifique*, July 14, 1886. He stated that the veil is an obligation established by jurisprudence, not by Islam. At the time of this study, it has conducted empirical research every aspect of the Moslem region. According to him, the veil is not a phenomenal thing for the Islamists. Long ago before, Jews and Christians also wear them. In this case, Snouck seems more confident that the veil is more of a tradition of the East, rather than an Islamic doctrine itself. Snouck found legal determination of Veil (hijab / khimar) highest is based on consensus (agreement of scholars). Furthermore, he states in the Islamic dress is a dress according to decency, or are in the language of religion termed *ma'ruf*. *Ma'Ruf* itself implies relativity; meaning depends on the context of the times (space / place and time). Locality / place / area is important in determining whether an outfit that *ma'ruf* or not. Highly dependent on culture, customs, social ethics and sometimes depending on the political regime in power.

The latest research related to the veil and hijab is done by Fadwa El Guindi, a professor of anthropology at the University of California (1999). El Guindi comprehensively analyze veil and put it in the context of multidimensional dressed as a communication model that is constructed from a

---

<sup>6</sup> Saparinah Sadli (1999), *ibid.*, h.170

<sup>7</sup> [http://72.14.235.132/search?q=cache:I1Q8T5uN3nAJ:www.pks-kotatangerang.or.id/index.php?option=com\\_content&task=view&id=455...+Sejarah+telaah+menyimpan+begini+banyak+catatan+tentang+diskriminasi+jilbab+&id&clnk&cd=1&gl=id](http://72.14.235.132/search?q=cache:I1Q8T5uN3nAJ:www.pks-kotatangerang.or.id/index.php?option=com_content&task=view&id=455...+Sejarah+telaah+menyimpan+begini+banyak+catatan+tentang+diskriminasi+jilbab+&id&clnk&cd=1&gl=id)

<sup>8</sup> <http://72.14.235.132/search?q=cache:A8qZEoEcZdYJ:rhisy.blogspot.com/2007/09/04/20/>

<sup>9</sup> [www.pks-kotatangerang.or.id/index.php?option=com\\_content&task=view&id=455... - 27k](http://www.pks-kotatangerang.or.id/index.php?option=com_content&task=view&id=455...-27k)

<sup>10</sup> Fadwa El Guindi. *Jilbab : Antara kesalehan, kesopanan, dan Perlawanan*. Serambi : Jakarta, 1999, h.25-26.

cross-cultural knowledge, interfaith, and cross-gender. Through a lengthy research, including field studies over the years, professor of anthropology has produced findings that the veil turns an age-old phenomenon that is rich in meaning and nuance. Hijab could serve as a messenger socio-cultural language. This study is the result of field observations on contemporary Islamic movements. Analysis and reanalysis data are applied in pure synthesis between ethnography, history, text of the Qur'an, Hadith and commentary.

Etymologically<sup>11</sup> In English, the term veil (as well as other European variants, such as voile in French) is usually used to refer to the traditional cover the head, face (eyes, nose, or mouth), or a woman's body in the Middle East and South Asia. Contained lexical meaning of this word is "cover", in the sense of "cover" or "hide" or "disguise". In Arabic, the word veil has no proper match. The Encyclopedia of Islam mention hundreds of terms to indicate the parts of clothing, which is mostly used for synonym veiling.<sup>12</sup> There are terms which has similarities with veil, such as *'abayah, burqu', burnus, disydasya, gallaiyah, gina', gargush, habarah, hayik, jellabah, mungub, milayah, niqab, yashmik.*

Argumentation in Al-Quran which obligate women to wear veil<sup>13</sup>:

(QS. Al Ahzab: 59)

*"O Prophet, tell your wives and your daughters and the women of the believers to bring down over themselves [part] of their outer garments. That is more suitable that they will be known and not be abused. And ever is Allah Forgiving and Merciful."*

Argumentation in Al-Quran which not obligate women to wear veil<sup>14</sup> :

(QS. An Nur: 31)

*"And tell the believing women to reduce [some] of their vision and guard their private parts and not expose their adornment except that which [necessarily] appears thereof and to wrap [a portion of] their headcovers over their chests and not expose their adornment except to their husbands, their fathers, their husbands' fathers, their sons, their husbands' sons, their brothers, their brothers' sons, their sisters' sons, their women, that which their right hands possess, or those male attendants having no physical desire, or children who are not yet aware of the private aspects of women. And let them not stamp their feet to make known what they conceal of their adornment. And turn to Allah in repentance, all of you, O believers, that you might succeed."*

Indonesia itself is one of the largest Moslem country in the world, but the phenomenon of veiled (and niqab) just started to get public attention in recent years. Over the mass media's role in legitimizing the presence of Moslem dress, then veil become the new needs of moslem women. It is associated with the New Order government policy that had banned the use of veil in schools or in the workspace.<sup>15</sup> Post-reform veil began to get his freedom as the identity of moslem women, although there is still controversy about the meaning of the use of veil.

Niqab is an advanced version of the use of the hijab, the Islamic commentaries itself postulates governing the use of the veil compulsory or not is debatable. But one thing is for sure, the use of the veil consequence greater rejection of the veil. In addition to the issue of stigma that is attached to the veiled women of Islam flow fundamentals (read: hard-line pen) are also closely related to terrorism, the veil is now also facing technical rejection, especially with regard to public services. As happened in North Sumatra University (USU). Because veiled, two prospective student doctors could barely finish college. Faculty of Medicine, University of North Sumatra (USU) to establish a ban on female students wearing Moslem clothing veiled.<sup>16</sup> In the end both the student must choose between removing the veil or moved from the Faculty of Medicine USU.

---

<sup>11</sup> Fadwa El Guindi, (1999), *ibid.*, h.31

<sup>12</sup> Encyclopedia of Islam, 1986, p.745-746)

<sup>13</sup> <http://moslemah.or.id/fiqh-moslemah/hukum-cadar-dalil-dalil-ulama-yang-mewajibkan-1.html>

<sup>14</sup> <http://moslemah.or.id/fiqh-moslemah/hukum-cadar-dalil-dalil-ulama-yang-tidak-mewajibkan-1.html>

<sup>15</sup> Alwi Alatas. Kasus Jilbab Di Sekolah-Sekolah Negeri Di Indonesia Tahun 1982-1991.

<sup>16</sup> <http://majalah.tempointeraktif.com/id/arsip/2001/01/22/PDK/mbm.20010122.PDK77163.id.html>

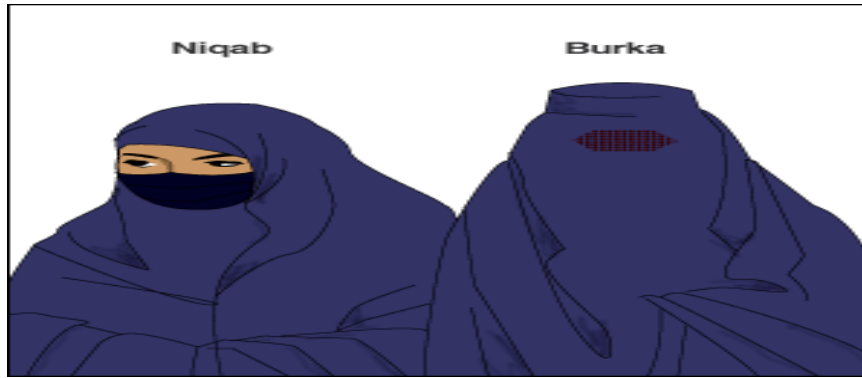


Figure 1. Niqab and Burqa

Of cultural development, the researchers saw that the veil has the potential to be accepted by most people, unfortunately not the case with the niqab. Moreover, post-terrorism, veiled women necessarily have new limitations, not only must accept the 'nature' as a woman, a new form of discrimination, either explicitly or implicitly becomes inevitable, meaning veiled women experience multiple discrimination. This is what makes this issue feasible and interesting to be in a scientific study.

In this study, we wanted to see from the internal side of the veiled woman, what really underlies the selection of their identity that attach themselves in environment that's not supported their beliefs. How is the process of formation of consciousness of veil, furthermore what exactly is the meaning of the veil, and how they define or define themselves in the context of veiled women.

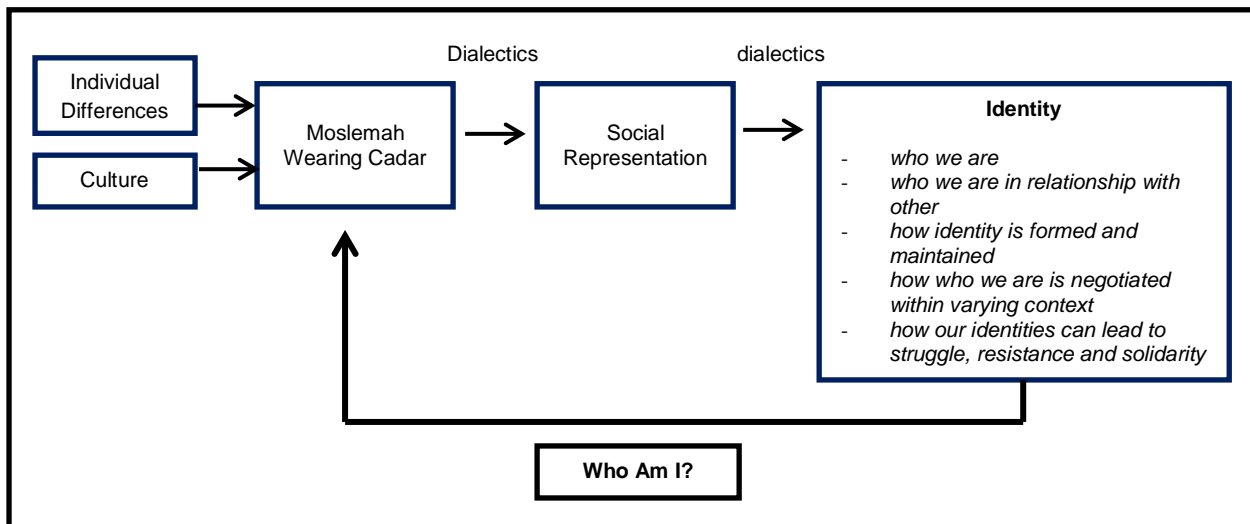


Figure 2. Thesis : Determining "Who Am I?" (How Self Concept Form)

## B. METHODS

In this study, researchers used a qualitative research method with a phenomenological approach that is an approximation of how the world in the experience of subject, based on epistemological assumptions that reality is what is in subject imagination. This study use constructivism paradigm which saw human experience consists of a meaningful interpretation of the reality and not a reproduction reality. Phenomenology as a knowledge that can arise because sense of curiosity. Fenomenogi regarded actual experience as data of reality which studied tend to the depiction and also interpretation of symptoms or phenomenon.

The subject of this research consists of 3 (three) people. With the characterization of informant as women, moslem and use the niqab permanently. Based on initial observations, considering community moslem women with niqab can not be easily accessed by researchers, then to get preferable informants, the researchers used a technique of sampling, snowball sampling..

Researchers approached the first informant who also will be opening the way to recommend other informants and cooperative information-rich. This continues until the researchers had enough with the information obtained. Data retrieval will be done by in-depth interviews. Interviews were conducted as natural as possible so disayapkan able to provide richer data because there are no boundaries between informants and researchers. The interview guides are questions capable of describing in more detail the concept of identity formation.

The first stage of data analysis was open coding, where the interview is marked or coded to concentrate data into specific categorization. This stage brings the researcher who was just looking at the data on the surface, to be more entry, far into the data obtained. The second stage is the axial coding. In this second phase, researchers will concentrate on themes or categories that have been granted in the first stage earlier, than in the data. This stage is the stage where the researcher questioned about the causes and consequences, conditions and interactions, strategies and processes, and look for concepts or categories that can be grouped together. The third stage is the selective coding. At this stage, researchers identified the main theme of research, selectively, researchers look for cases that illustrate the theme, and make a comparison, after the whole collection of the data collected is perfect<sup>17</sup>

## C. RESULTS

### Informants profile veiled women

Hara is the first informant in research on the identity of moslem women, the study analyzes fenomenologi moslem women with niqab in Jakarta. The researchers also have an affinity for choosing this theme as well as the problems faced by Hara. As a moslem woman with niqab, after more than 6 years of using the niqab, she was forced to relinquish the niqab simply because of university regulations. UIN Jakarta especially Faculty of Public Health not tolerate students with niqab. Women who were born in Jakarta 21 years ago, passher childhood by being educated in boarding school. Apparently understanding of niqab not only from family but also acquired during at boarding school. Although at first she used niqab as an obligation in school, but with the passage of time there is a strong desire to retain the use of niqab. For her niqab more valuable (afdol). For women, niqabl is not a barrier to women existence.

Researchers have access to chat with informants 2 through recommendations given by the informant 1. Zahra Mar'i spent her childhood moving. She was born to a religious family because his father was a preacher. Since childhood she was pleased explore Islam through propaganda delivered by Buya Hamka. At 27 years old, she is married to a man named Abu Hanifa, Javanese descent. He reveals, together with the husband began to study religion self-taught, do not follow the formal religious education in school. He honestly expressed only in school only up to primary level. The journey understanding of Islam lead her to jemaah in Kebon Jeruk called Tabligh. From there she began to recognize the niqabl and finally came to the decision to use the niqab in 1995. Her insights of niqab, she regarded as an effort to achieve a better faith, afdol. She enjoyed her role as a housewife who sometimes helps her husband in the field of business batik business. Mothers are those who have control over the education of the child, including the cultivation of religious values from an early age.

Informants number 3 in this study obtained for the appointment of a second informant. Aliya 39-year-old Abdullah is a housewife who sometimes helped her husband run fashion bussines, Pasar Senen Jakarta. Mother of four childrens is a Java-Chinese descent, and live in families of different religions. This Informan initially was a career woman, outgoing, go to discotheques and far from Ilamic life which was never taught by her parents, she defined it as Islam KTP (only status on citizencard). Informant 3 initially unveiled but because her husband joined the congregation, she decided to wear veil, but short veil, finally in July 2008 decided to use a veil. TV, radio, tape, the Internet is never used since she improved the understanding of Islam. Only limited use of mobile phones for communication, when she received a call from a man who is not mahram (forbidden married person) as much as possible is very short because he thinks the voice of women is *aurat*.

---

<sup>17</sup>Neuman, 2003: 442-445





Figure 3 : Informants, Left (Hara), Right (Zahra Marie)

### Niqab in Indonesia

Indonesia is one country whose population is predominantly Moslem. Based on population surveys in 2005, amounting to 218 868 791, as much as 88.58% or 189 014 015 moslems. However, according to Clifford Geertz, especially in Java, the community consists of Islamists who are classified as upper class, students, and *abangan*. This has led to the term "Islam KTP". How real life often become confused fused Islamic culture between generations that have been previously attached. Among the arguments in the Quran and Hadits, some contextualized in Indonesian culture, consequently some things that should arbitrate shall be rejected because it is not Indonesian culture.

Veil, one of Arabian culture which considered incompatible with Indonesian culture, especially if associated with tropical climate. Wearing veil will seen as a form of narrow fanaticism that disrupt diversity. It is considered to be justification for veil banning in educational institutions and commercial enterprises. On post-reform era, the veil began to gain his freedom as the identity of Moslem women, although there is still controversy about the meaning of veil. After prohibition for employees who wear veil by Sun Department Store in Cilegon.<sup>18</sup> In some cases, it seems only the province of Aceh which has priviledges govern a county based on Moslem value. When the military began to examine the discourse to allow its members to wear the veil, Head of Public Relations Inspector General Police Headquarters. Pol Sisno implicitly explain the rules regarding uniform policewoman in Indonesia "There is no ban, all citizens have the same rights. But already there are rules, of the police uniform, there are criteria for members of the policewomen, except in Aceh."<sup>19</sup> Its similar thing with the selection for member of Paskibra in Kediri on 25-26 April 2007, the selection committee of the Ministry of Education Kediri ask five schoolgirl to remove their veil and lift their long skirts, the committee argued that it has become standard provisions participant National Paskibra , unless the student from Aceh.<sup>20</sup> On Unity Marching Competition (LPBB) which holds one of prestigious school in Semarang, SMA 3 Semarang, Februari 2015, we can see how some member with veiled has to wear short skirt, which is not appropriate costume for girl with hijab.



<sup>18</sup><http://soero.blog.friendster.com/2008/09/larangan-jilbab-oleh-matahari-diskriminatif-dan-melecehkan-2/>

<sup>19</sup><http://www.detiknews.com/read/2007/12/14/202344/867358/10/polisi-wanita-berjilbab-tersandung-aturan-kapolri>

<sup>20</sup>[http://alislamu.com/index.php?option=com\\_content&task=view&id=257&Itemid=38](http://alislamu.com/index.php?option=com_content&task=view&id=257&Itemid=38)

Figure 2. LPBB, Semarang, Februari 2015

For Moslem women, hijab is obligatory. Covering *aurat* to protect them from the male gaze is goodness criteria for moslem women. Proposition of the veil appears several times in the Qur'an that is An-Nuur 24:31. The rejection of veil by some moslem women in Indonesia is because of there are fearness of the limitations that inherited on the use of veil.<sup>21</sup> Meanwhile, the acceptance of veil supported by existence of role model (ie.selebrities, *ustadzah*, public figures), the emergence of fashion houses, also media exposure that began providing space for veiled women.<sup>22</sup> Not only in the religious ceremony, the veil is also used in daily activities, in public spaces. Hijab become the new identity of moslem women in Indonesia. Hijab no longer be unfamiliar, and frightening, identical with the arabian culture, it adds a positive value that is associated with progresive quality of faith. Hijab should be used when get in touch with other people who are not mahram.<sup>23</sup> The hijab is obligatory for moslem women, especially for women who are already legally *baligh*.

Niqab is an advanced version of the veil. Women with niqab add masks so that only their eyes visible, even palms must be covered. If veiled also requires the use of a long shirt, then niqab followed the robe usage habits (not shorts), long skirts and wide, and usually the entire accessories black or dark colored. Researchers saw no reaction tendency Indonesian people who are familiar with diversity. If the veil could fit into the local culture, niqab had the same opportunities. But until now, the niqab has not been able to penetrate the mass media, where the production of popular cultures. So we can be sure the niqab has not been popular. It can be read as a way people view niqab, Niqab still become scary odd thing. This is supported by stigma from massmedia, which judge women with niqab as 'terrorist's wife', 'Islamic hard-liners', 'Islamic fanatics'.<sup>24</sup> Exclusivity of veil communities also hinder the process of socialization. Not to mention the all Indonesian people want to know, from the pattern of the collective society, seeing things that are completely enclosed making them reluctant to interact further. From indonesian people majority opinions, niqab is not indonesian culture, not yet. This phenomenon require further intensively studies, to achieve positive perspective of niqab because niqab seems still belong to a community that specializes study Islam.

While based on observations in the field, women with niqab never felt awkward communication with their neighbors, although they must first initiate communication because the neighbors do not recognize them in the niqab. This is based on the concept of moslembrotherhood, all moslems are brother to each other. Moslem women with niqab also receive visitant, whose not wearing niqab, or unveiled, or even of different religions in order to missionary endeavor. Their closure is due to the belief that the best of women are women who are stay at home. For women with niqab<sup>25</sup>, using the niqab not only the concept of the protection of women in the Quran and Hadith, but also *taqwa* culture which are implemented in everyday life.<sup>26</sup> By using the niqab, they feel closer to Allah.

### **Niqab: Identity Moslem Women**

Identity is the self as reflexively understood by people in the context of her biography. Stories identity seeks to answer some critical questions of what to do, how to act and wanted to be anybody. Individuals trying to construct a coherent narrative identity which themselves form a developmental trajectory from the past to the future can be predicted.<sup>27</sup>

#### **a. Self Concept of Women with Niqab**

The concept of self (self-concept), or the perception of a relatively stable, about herself.<sup>28</sup> Questions about "who am I?" The answer is related to the concept of self. Recognized by the

<sup>21</sup>Some women expressed more important is the heart menjilbab first.

<sup>22</sup>The phenomenon of hijab and veil began to boom after the movie "Ayat-Ayat Cinta", after it like pop culture, veil-soap operapresent in the soap opera that aired on prime time, such as moslemah, hareem, munajah cinta,etc.

<sup>23</sup>Which includes such mahram, 1. Husband, 2. Father, 3. male-laws, 4. Boys Stepfather, 5. brother, 6. Boys of brother and 7 women. fellow woman, slave 8., 9. the waiter (male) who have not had the desire to women (because it is old), 10. the boy who has not been affected by the female *aurat*.

<sup>24</sup>"TPM curigai kuasa hukum Abu Dujana"

[http://www.wawasandigital.com/index.php?option=com\\_content&task=view&id=4340&Itemid=1](http://www.wawasandigital.com/index.php?option=com_content&task=view&id=4340&Itemid=1)  
Dan "Agus Setyadi dkk Mulai Diadili". <http://www.suaramerdeka.com/harian/0702/20/nas19.htm>

<sup>25</sup>Akhwat is sisterhood

<sup>26</sup>Running commands and obey His prohibitions.

<sup>27</sup>A. Giddens. *Modernity and Self Identity*. Polity Press : Cambridge, 1991, p.53-75

<sup>28</sup>Richard West dan Lynn H. turner. *Pengantar Teori Komunikasi*. Jakarta: Penerbit Salemba Empat, 2008, h. 101

individual characteristics of its physical characteristics, roles, talents, emotional state, values, skills and limitations of social, intellectual, and so on to form the concept itself. Individuals develop self-concept through interaction with others.

Women with niqab have confidence by wearing niqab add new attributes in themselves which must be implemented into everyday activities ie *takwa*. The first interesting thing is the fact that moslem women with niqab tend to identify themselves as a wife and not herself, it is seen from their unwillingness to give real names giving by herparents, they are more convenient called *Aliya* \_\_\_ (her married name), this is also related to the belief that the name also *aurat*. Veil is always attached to the image of sholehah women (related to *takwa*). Moslem women with niqab to focus his life for the life after life.<sup>29</sup> Women with niqab no longer struggling with obligations as a Moslem, but rather enrich the practice of the *sunnah* of the Prophet. For moslem women with niqab, the Al-Quran and Hadith are no longer open to question, but automatically believed and implemented. *Sami'na Wa ato'na*.<sup>30</sup> It also makes moslem women with niqab have a strong character and sincere<sup>31</sup>, because they realize not easy for anyone, even if that fellow Moslems to accept their existence without questions.

### **b. Moslem women with niqab and the World**

Although wearing niqab, as fellow Moslems should keep *ukhuwah Islamiyah*. Instead of forcing, for other women who have not wearing niqab (and veiling) informants only focus on missionary endeavour with pure knowledge and pray for fellow Moslems always get guidance so they can go to heaven together. Discrimination against moslem women with niqab are other consequences for becoming marginal subjects. Informant 3 claimed toughest obstacles when using the niqab outside the home is identified with terrorism and followers of cult, even a few times she was called by a *ninja*. Though he has never been treated unpleasant because it uses a niqab, but informants 1 and 2 saw the potential for the different behavior of the surrounding community.

Moslem women with niqab tend to limit their contact with the affairs of the world. For example, in 2009 the last elections. Informant 3 and her husband to vote in the election, but deliberately made unvalidate because the principles they believe. When they asked about terrorism as jihad, three informants disagree, even informants 2 declare jihad can be realized in work, learning and best jihad is a war against lust. Likewise, when asked about the stigma of moslem women with niqab with terrorist wife, informants 1 believe that it is only the construction of the mass media. About polygamy that became the focus of attention to Islamic values are considered discriminan, informants 1 accept it as written in the nobel Quran, but she added that any criteria or requirements that must be accomplished. About dating, as informant status is not married, Informant 1 stated there is no term for date in Islam.

### **c. How Faith Shaped and Maintained**

Based on field observations, forming erect religious understanding can arise in two families extreme conditions, which have Arab ancestry so always shaded in Islamic culture thicker as informants 1 and 2, or from a mixed family, allowing each family member to freely seek understanding beliefs optimally as informants 3 in her family there are 3 different religions (Islam, Hinduism and Buddhism).

For Moslem women, the decision to use the niqab was not significantly influenced by age, and academic education, but more because of the openness of access to intensive study Islam and access to the niqab community. This is evident from the diversity of educational backgrounds informant, where informants 1 is still registered as a student at the State Islamic University, while informants 3 academy graduate secretary, and informants 3 just to complete primary education. All three have access to study Islam ie from boarding school that require students to use the niqab, and as happened in the first informant, through regular recitation as the informant 2 and 3, coupled with Islamic books, for example *Fadilah Amar Maulana Ilyas* work. All three also have access to community *Tablikh* congregation whose headquarters is based in Kebon Jeruk, where almost all his congregation using niqab.

---

<sup>29</sup>In one of his sermons at informant 3 house, stated that "those who pray (pray required) has been a lot but who dare to leave the world just a little bit. And the example of the Prophet who can not do the people of today are, how they are excited as soon as possible to spend a treasure in the way of Allah, and winged sprint towards the hereafter. "

<sup>30</sup>*Sami'na Wato'na* means We hear, and we obey. Often attached by the behavior of angels who never violate the commands of Allah. This sentence pronounced by the cleric who fill material muzakarra (recitation) at home informant

<sup>31</sup>There is an incident narrated in the study, of veiled women are finally prying eyes as a man declares his proposal to marry for reasons to fall in love seeing beautiful eyes. It is seen as evidence of a strong love for God.



While the influence of marriage and the husband's role is to support to facilitate the use of the veil. Being the wife would be perfect if it did hijab (covering), so only their husband who could see her, because with a face still can invite attraction of the opposite sex. Wearing Cadar as a representation of *takwa* cloth, is a process that requires time and an guidance from their husband, informants 2 takes 15 years and informants 3 takes 7 years, but the informant has a husband who first active in the congregation tabligh and active preaching, even when husband interviewed informants 3 were *out* (da'wah) to Pakistan for four months.

Based on observations in the field, also found that the dominant pattern, especially related to the economic conditions of the women with niqab. Although they don't interests in material, the third informant in the category AB, which means that they economically middle to upper. It also can be seen from the condition of informant houses. Researchers read it as a strong influence on the courage to wear niqab. This is due to decide for wear niqab means being ready to face the double discrimination (as women and as a veiled woman). It is difficult if not supported by the ability of the economy is good, because it is associated with dependence on other people's lives.

In a veiled belief maintenance, all informants oblige to add sunnah practice as much as possible, as did the second informant who love to read the noble Quran, although one or two paragraphs, including Assajadah, Al Kahf, Al Wakiah which never left behind. These informants are active in teaching or in terms of their "outing".<sup>32</sup> In the 'outing' that knowledge is obtained from many *ustadz* and *ustadzah*, often also imported directly from headquarters (international center) which is India.

#### **d. How Beliefs Negotiated**

Moslem women with niqab live a life like other people, however, has behavioral consequences which also should be obey. Moslem women with niqab may be out of the house, but for the sake of missionary endeavour and even then should be with her husband.<sup>33</sup> Moslem women with niqab still go to the mall, but only buy daily necessities. Women can come to trade, but her position should not be in the public domain, just to help her husband in the store as informants 2 and even informant 3 who had a shop in Pasar Senen. Moslem women with niqab to respect neighbourhood chatter, but do not follow the neighboring community organizations as well as social gathering, they only hold a *pengajian* that allows anyone who wants to learn to come.<sup>34</sup> Women should be educated to the highest level as one informant who is still listed as a student UIN Jakarta, but when married leave the decision to the husband, as a good wife too principled *sami'na wa ato'na* to her husband.<sup>35</sup>

The use of communication media maximized for useful only. Moslem women with niqab using even the latest mobile phone (blackberry-pen), but only limited use to communicate, even if the informant 3 restrict speech that is not a mahram for voice calls as well *aurat*. Moslem women with niqab using mass media such as TV, radio, newspapers, but only consume news, musikpun selected Islamic nuanced even informants 3 using four tv at home just for cctv,

"For what? it is the world. TV, radio more is not beneficial. If you already like me, do not need to know the world, we are the deeds for the hereafter only. "

Special informants 1, recently for the first time to watch a movie in the movie theater "Perempuan Berkalung Sorban" to see the depiction of the boarding school attached to her life since childhood. In addition she is also taking books out of Islam ie comic detective conan, da vinci code, also books, however nuanced Islamic chicken soup as works Asma Nadia and Helvi Tiana Rosa. While for the second informant, she really liked the book, but in addition to the books of Islam, she was only interested in women themed books.

#### **e. Resistance and Solidarity moslem women with niqab**

In addition to the written media such as books, electronic media such as TV is a source for information and entertainment. But with the discovery of the fact, the statement does not apply. The same pattern was found in both informants 1, 2 and 3 that they showed strong resistance to the television media. Even informant two states do not have a TV to be used as a medium of information

---

<sup>32</sup>In the community tabligh congregation, *outing* is the term for the missionary endeavour. This outing routine, organized and are required because they found that one third day of the year shall be used to talk about religion, especially for men. Women in this case should support, both in organizing the house while their husbands go, or accompany her husband. Outing is about 3 days, 15 days, 30 days, and 4 months.

<sup>33</sup>This is the culture of Islam, as the Iranian government records also impose rules that women should not be in and out of Iran unaccompanied relative. The reason is to maintain the honor of women

<sup>34</sup>As *ustadzah* who fill material, Aliya Aminudin, opened her house every day 9-11 hours a week to recite

<sup>35</sup>The difficulty of this research is partly because the disallowance of her husband for an interview even though in the context of research. They objected because the results will be published. One of the presenters, Aliya Irfan, said the publication of science is not the sunnah, more *mudhorot* its (negative things that will appear).

or entertainment. Even if the informant was limited only to watch TV on news programs or political news program that is packed with entertaining concept, as one informant who only watch Metro TV and the "Republik BBM". All three are strongly rejected soap opera, especially infotainmentprogramm. This is because in real life they avoid backbiting (talk about someone else) and saw no benefit of soap opera.

The similarity of background and beliefs often creates a strong solidarity, however, a sense of solidarity that appear in moslem women with niqab to solidarity with fellow members of the community.<sup>36</sup> When commenting on the prohibition of the use of the niqab at Nort Sumatra University (USU) students and led to the dismissal nurse who wear niqab in private hospital in Jakarta, the informants only regretted the incident, but not necessarily making provocative statements much less organized opposition action.

#### **D. CONCLUSION**

Based on the results of the study found the cadar women tend to identify themselves as a wife, mother, and not herself. The cadar women tend to limit their contact with the world, including restrictions on media exposure. The decision to use the cadar was not significantly influenced by age, and academic education, but depend on opened access to study Islam intensively and access to the cadar women community. For them, cadar is takwa clothes, its better, because they think whole women body is aurat. The cadar women live like others normally, however, with cadar, they has their own exclusive social norms to perform.

#### **E. REFERENCE**

- Arivia, G. (2003). *Filsafat Berspektif Feminis*. Jakarta : Yayasan Jurnal Perempuan.
- Barker, C. (2008). *Cultural Studies: teori dan praktek*. Yogyakarta: Kreasi Wacana.
- Berger, P. & Luckmann, T. (1990). *Tafsir Sosial Atas Kenyataan*. Jakarta: LP3ES.
- Boeree, G.(2004). *Personality Theories*. Yogyakarta:Primasophie.
- Coleman, R.(2002). *Say it Loud!: African American Audiences, Media, and Identity*. Londodn: Routledge.
- Duveen, G. (ed). (2001). *Social Representations: Explorations in Social Pshychology*. Polity Press.
- Fromm, E. (2002)*Cinta, Seksualitas, Matriarki dan Gender*.Yogyakarta: Jalasutra.
- Giddens, A. (1991). *Modernity and Self Identity*.Cambridge: Polity Press.
- Berten, K. (2001). *Filasafat Barat Kontemporer*. Jakarta: Gramedia.
- Liliweri, A. (2002). *Prasangka dan Konflik : Komunikasi Lintas Budaya Masyarakat Multikultur*. Yogyakarta: LKIS.
- Moleong,L. (2002).*Metode Penelitian Kualitatif*.Bandung:Remaja Rosdakarya.
- Moscovici, S. (1963). *Attitudes and Opinion*. Annual Review of Psychology  
-----, (2000). *Social Representation*, edited by Gerard Duveen. Polity Press dan Blackwell Publisher.
- Mulyana, D. (2002). *Metode Penelitian Kualitatif*. Bandung : Remaja Rosdakarya.
- Murniati,N. (2004). *Getar Gender: Perempuan Indonesia dalam Perspektif Agama, Budaya, dan Keluarga*.Magelang : Indonesiatera.
- Neuman, L. (2003).*Social Research Methods: Qualitative and. Quantitative Approaches*. New York: Allyn and Bacon.
- Potter, J. And Linton, I. (1985). *Some Problem Underlying the Theory of Social Representations*. Great Britain : British Journal of Social Psychology.
- Ritzer, G. (2003).*Teori Sosiologi Modern, 6ed*.Jakarta: Kencana.
- Sadli, S. (1999).*Pengembangan Diri Perempuan Dalam Keluarga dan Lingkungan Sosial*.Jakarta : Balai Pustaka.
- Sartre, J. (1956). *Being and Nothingness*, terj. Hazel E. Barnes. Citadel Press.
- Smith, JA., Harre, R.& Langenhove, L. (1995). *Rethinking Psychology*. Sage Publication.

---

<sup>36</sup>Based on field observations, summarized the unique facts about the care management of children whose parents do 'outing', members of the congregation would 'scramble' volunteered to care for their children voluntarily.

## **CULTURE VALUES IN *RAMAYANA BALLET* PRAMBANAN YOGYAKARTA (AN ASSESSMENT SEMIOTIC)**

Fifi Nofiyanti

fifi.nofiyanti04@gmail.com

Indonesian Education UHAMKA Jakarta

### **Abstract**

Abstract scientific article is the result of research in Prambanan. The results of this study seeks to preserve the *Ramayana* in a variety of educational activities, seminars and scientific journals. *Ramayana* is a blend of Indonesian culture and dance dramas are usually staged in the courtyard of Prambanan, Yogyakarta. In Java, there are many temples that stood firm, with the largest and most famous temple are Borobudur and Prambanan temples. Carved reliefs found on the walls of the temple are beautifully engraved and has a story inside a story. Research on this *Ramayana Ballet* performances using observational methods and analyzed using semiotic studies based on culture values, by studying the *Ramayana Ballet* through books and watch the show to assess culture values contained in the *Ramayana Ballet* with semiotic studies. Having carried out the research found the results, that the *Ramayana* contained therein culture values in the three states, namely ideas, actions, and artifacts. Every movement made by the dancers, although not using dialogue, but has a wonderful culture values. Culture values are divided into three, namely: in the form of ideas, actions and artifacts. In assessing the value of this culture is used table analysis with semiotic study of Pierce. Based on the analysis conducted shows that there are 37 culture values on *Ramayana Ballet*. There are 16 icons, 11 indices, and 9 symbols depicted in the show. Based on the study found that culture values: 8 ideas, 21 action, and 12 artifacts that are used in this staging. The use of red color worn for evil character figures, used by Rahwana figures, Trijata and figures of the royal Alengka. The use of gold used by the character well, there is the figure Shinta, Rama, Laksmana, and some other figures. Culture beauty of the show *Ramayana* is contained in the clothes worn are: cloth, scarves and hats, crowns, jewelry, anklet. It is a form of physical culture.

Key Words: *Ramayana Ballet*, culture, semiotic studies

### **INTRODUCTION**

Indonesia has a wide range of beauty. The beauty of it can be seen that there is a culture in Indonesia. Indonesian society has a lot of knowledge stored in various ways, but most Indonesian people who live it many do not realize it. In written language there is a beautiful literature in the form of classic literature (tale, legend, chronicle, epics, couplets, Seloka, and so on), and modern literature in the form of short stories, novels and drama. Through spoken language and body language are folk songs, dances, dialect, and other traditional clothing. Various buildings contained in this country is the physical evidence of civilization that occurred in the past.

In Java, there are many temples that stood firm, with the largest and most famous temple of Borobudur and Prambanan temples. Carved reliefs found on the walls of the temple are beautifully engraved and has a story inside a story. Staging *Ramayana* is what is taken from the reliefs at Prambanan temple. Based Republika.com (Sleman), *Ramayana Ballet* in Prambanan was awarded the Guinness World Record in the category of the highest number of dancers. The award was presented Lucia Sinigagliesi as Client Service Director after the show on Monday (15/10) night.

*Ramayana Ballet* performances can be seen in both indoor and outdoor, such provision has been scheduled by the organizers. Enthusiastic audience at any time the show is not too much, but it was witnessed by local and foreign audiences. The show played by applying *Ballet*, the art of drama and dance. Presented the audience with a dance drama about *Ramayana*, without the use of dialogue in each of the characters. But to know the meaning of the *Ballet*, we can see from every symbol and the sign used by the player. Shows *Ramayana* which is typical of Indonesia, having culture value in it. Therefore, to know and understand these performances conducted a study evaluating the *Ramayana* is based on culture values. However, the sign contained in the play can be observed and attributed to the study of semiotics, the science of sign.

To uncover and get to know the culture of Indonesia in the form of a deeper *Ramayana*, the authors are interested in researching Culture Values In the *Ramayana* at Prambanan temple in Yogyakarta (A Study of Semiotics).

## LITERATURE REVIEW

### **Ballet**

Sendaratari for some people not very well known. However, understanding the meaning of *Ballet* sometimes be wrong. Conjecture is derived from the word “dance” combined with the word “sendra”, so many people are guessing not much *Ballet* dance activities. Basically *Ballet* is an acronym of the art drama-dance, as the name implies this activity is a combination of drama and dance. This activity has two different senses, but often together in a staging.

According Soedarsono in Mary (2011), dance is a dance drama that tells the story, a good dance performed by a dancer as well as by several dancers, whereas the non-dramatic dance is a dance that is not telling.

## **Ramayana**

The birth of a traditional old literature or different from modern literary works. In traditional literature, the relationship between literature and literary communities in which it was born, very closely. Ikram (1997: 11) argues, the literature circulating in the community and be hers for some time before. Between oral and written literature is very faint difference. If at any time there is a write and record, so he did not feel called himself the author. *Ramayana* or known as *Ramayana Ballet* which combines elements of drama and dance that tells the *Ramayana*. India is famous for its two epics of *Ramayana* and Mahabharata magnitude, which is much discussed in the humanities and literature. In Indonesia *Ramayana* carved on the Siwa temple is one of the temples of Prambanan. *Ballet* can be interpreted as a drama with elements of dance in it. Elements of dance, performed by the play or character meaning in it, but when the witness is not all visitors understand all dance and meanings contained in the *Ballet*. It makes people just enjoy it as entertainment only and ultimately deeply ignorant culture values.

## **Value**

Discussing problems sometimes we assume the value of a score or numbers that appear. Value is also used as a benchmark in obtaining success. According Setiadi in Horton and Hunt (2013: 119), the value is the notion of what it means or no experience. Values are general concepts about something that is considered good, worthy whose existence aspired, desirable, internalized, and implemented in everyday life and the purpose of life together in the community, ranging from units of social unity smallest to the tribes, and the international community.

Everyday human life, we use the word value to say something meaningful and have a useful concept. According to Segers in Suyuti (2000: 61) the concept of value appears to be one of the important topics in the study of educational literary studies. Examples, course of obtaining knowledge, become better people, to change the

negative into a positive. Indonesia has a variety of cultures, then there is a culture value in each region, either in the form of language, dance, food, clothing, and behavior. It became something of value and do everyday by the people.

In Setiadi, et al (2009: 31) explains that the value is a good thing that always desirable, idealized and considered important by all human beings as members of society. Therefore, the things that can be said to have value is something that is useful and valuable example of truth values, moral values, religious values (religion). In contrast to the concept of “value” in the school results in the form of a score in the form of numbers and letters. Things that look abstract has a value, for example, only in art, paintings that seem easy to understand but has high artistic value for people who understand. In this *Ramayana Semdratari* there are many culture values in them, through the study of semiotics.

### **Culture**

In public life are the culture values contained therein. Because it is within a scope of beliefs and customs in the society. Culture is something that has value, because it is useful and valuable. According Setiadi, et al. (2009: 31), culture is the plural form of the word that means the mind and the power of love, intention and flavor. The word is derived from the Sanskrit language, *budhayah* is plural word *buddhi* which means mind or intellect. Culture in English is called culture that is all power and human activity to process and manipulate nature.

In society there is a culture, for example in Indonesia. Because Indonesia has various tribes and consists of islands. Indonesia has a diverse ethnic, have beliefs, customs and habits. It is a culture that has been passed down by our ancestors to the next generation to be preserved.

Various experts define culture with a variety of things, culture gets affix to late into the culture which has the meaning of “results”. So culture is the result of a culture. According to EB Taylor in Widaghdho (2010: 19), defines culture is a complex whole that it contains other sciences, as well as the acquired habits of man as a member of society. Humans are creatures of Allah the most perfect. Because in this world was created four kinds of Allah are human beings, plants, animals and nature. Among all creatures in this world is perfect only human, because given the sense to think. Culture means also sense derived from Sanskrit.

Culture is the result, copyright, and the work of man against nature around it. With reason and character, humans are able to process, create, creation, develop and improve everything that exists in this universe. For example, humans can construct high-rise buildings, make a variety of crafts, creating a sophisticated communication tools, and so forth.

The relationship between man and culture proposed by Tumanggor, et al. (2010: 17) that the human position in the culture as 1) adherent culture, 2) the carrier of culture, 3) manipulator culture, and 4) the creator of culture. As the bearer of human culture brings a wide range of cultures that exist, both local and foreign. But in this case, humans should be able to maintain its culture from being lost due to the influence of foreign cultures. In this case, foreign cultures come to a new society would be difficult to accept, as a wise man, the foreign culture can be used, if the culture is good for Indonesian culture. Man is said as a manipulator, it is declared to those who abuse the culture and not in accordance with the noble values of a culture. Top notch in this case is the man as the creator of culture. Humans are able to encourage and create a new culture to renew the old culture, but without destroying the existing culture.

Even able to give thought to develop a culture. Culture formation described above, intends to preserve the culture. So that people keep their culture, even if it is on a different social environment. Humans are creatures of culture, which is able to leverage the intellect and mind and feelings to create a culture. In Widaghdho (2010: 19) states that human beings are not cultured else is being constantly utilize his intellect to create happiness. Because human life is intrinsically happy something good, right and just, so to say, a man who always create goodness, truth and justice alone that holds a cultured man.

### **Attributes Culture**

Culture has developed in the community, but every community has a different culture. As in Indonesia, which has a different tribe. However, every culture has the same trait. The properties not defined specifically, but universally. The properties of the culture will have characteristics common to all human cultures regardless of ancestry, race, natural environment or education. That is the very nature of general application to all cultures everywhere. According Setiadi, et al., (2009: 31) intrinsic

properties of culture, among others: culture materialized and channeled from human behavior; culture has existed beforehand rather than the birth of a certain generation and will not die with age endless generations concerned; required by human culture and embodied in his behavior; culture include rules containing obligations, actions are accepted and rejected, prohibited acts, and actions are allowed.

### **Elements of Culture Values**

The realization of a culture are things that appear in the culture. Koentjoroningrat in Prasetya (2009: 32) describes culture form widened three kinds, namely a) a form of culture as a complex of ideas, means, values, norms, rules, regulations, and so on, b) culture as a complex form the activity pattern of human action in society, 3) a form of culture as objects of human handwork.

Broadly speaking culture Koentjoroningrat classify into: ideal form, a form of social and physical culture form (artifacts). The first form is the ideal form of culture. Is abstract, intangible and photographed. It lies in the nature of the human mind. The ideas in this human idea many who live in the community and giving life to the community. The realization of this ideal form of customs that are present in a society.

The second form is called a social system or social system, which is about the pattern of human action itself. The social system is composed of human activities that interact with one another from time to time, which is always in a certain pattern. In Herimanto and Winarno said the same thing about the culture form described by JJ. Hoeningman (2011: 25), which divides the culture form: the idea (ideal form), activity (action) of the social system, and artifacts (work). All these components are held as a culture element even be a factor builder of every tribe from the level of sectoral, regional, national, and international.

### **Semiotic Studies**

Semiotics (semiotics) is the science of sign. Science assumes that social phenomena or society and culture that is a sign. Semiotics was studied systems, conventions that allow the sign mean. In literature, the meaning of language is determined by the literary conventions or customized with literary conventions. Of course, because the material is language literature that already have systems and



conventions, it can not be separated completely from the system of language and meaning. Literature has its own convention in addition to language conventions.

Semiotics is derived from a reality that is present or represented the author to the reader that it contains a communicative potential marked by symbols which have a distinctive artistic value to the author. This is because of the power of expression continues to grow and evolve author that appeared variations writing techniques, linguistic symbols, distinctive style and a variety of other types of expressions.

According Sobur (2001: 95), etymologically derived from the term semiotic *semeion* Greek word meaning sign. While the terminology, semiotics can be defined as the study of the broad array of objects, events, across cultures as a sign.

Another opinion about the semiotics of Pradopo (2001: 71) states semiotics is the study of sign. This science considers social phenomena or society and culture that is a sign. Various views of experts on the semiotic refers to the science of sign that are in society and culture. Language as a sign or symbol, because the language in the form of words Semiotician Charles Sanders Peirce insists that we can only think by means of sign. is certain that without the sign we can not communicate. According Sujiman and Zoest (1992: 1) states Peirce proposes semiotics as a synonym word logic. Logic must learn how people reason. Reasoning is done through sign, sign that allow us to think, relate to others and give meaning to what is displayed by the universe.

A sign which he calls the representamen must refer (or represent) what he calls the object (reference, today people refer to it as referent). So, if a sign representing a reference, it is the primary function of the mark. Besides represent approval, representing angry glares. A sign referring to a reference (referent) and representation as it is the primary function. In addition, such a representation is made possible through the help of something, for example, thanks to the help of a code. Traffic sign can only be understood by those who understand traffic sign.

Something that can be used in order to sign function by Peirce called ground. Process representative of the reference marks occur when the sign was interpreted in relation to which it represents. That's what he calls the interpretant, which is understanding the meaning arising in cognition (receiver sign) through interpretation.

According to Pierce in Zaimar (2008: 1) describes the three elements of the mark, namely representamen, objects, and interpretan. Language is the sign (symbol) which indicates (symbolizes) something and that something is the meaning. In relation between literary semiotics, Semi (1993: 86-87) states that semiotics is the science of examining matters relating to communication and expression. In research literature, specifically examine the semiotic approach to literature that is seen to have its own system, semiotic not limited to the figure of the work, but also to connect with systems that are on the outside. Semiotic actually has a very long history since the days of ancient Greece, medieval and Renaissance through, until modern times. According to Pierce in Endraswara (2011: 64), there are three types of alerts based on the relationship between the sign with the signified, namely: icons, indices, and symbols.

The significance of these three types of sign is defined as follows: 1) The icon is a sign that shows the relationship between the natural character and sign marker. That relationship is a relationship equation. Icon is the simplest form, because it only displays objects that indicated they were, as the physical shape of the object. For example, drawing a horse as a marker that marks the horse (marker) as a means. Images marked the one portrayed, images of trees marking the trees, marking the icon image of your face yourself; 2) The index is a sign indicating a causal relationship (causal) between markers and sign. Index is some sensory features (something that can be seen, heard, or easily smelt. Words become the index is directly related to the intended meaning. For example, smoke marking fire, wind instrument marker indicates the direction of the wind, and so on; 3) symbol is a sign that indicates that there is no natural relationship between markers and sign, relationship is the arbitrator (arbitrarily). The meaning of the sign is determined by convention. "Mother" is a symbol, it means society is determined by convention language (Indonesian). British people call Mother. According Cobley (2001: 31), A symbol is somewhat more complicated. The series of signs in the above paragraph highlights with a symbol, 'Coke', a sign whose interpretation is a matter of *social convention*.

Based on these explanations, that to assess a mark by using the icon, index and symbol. It is to analyze the discourse, the story and the meaning of a passage. For example only, the index contained in the "Jakarta flooded after heavy rains

enough". This includes the index, because there is a causal relationship only between cause and effect that occurs. The floods after heavy rains enough, which is the cause of these events can be based on several possibilities, including clogged drains, garbage piling up and there is not enough space to accommodate water.

According Suratminto (2012: 165), the similarity with the iconic image of the object lies in the characteristics of referents that are not necessarily in the form of visual characteristics, also found on the mark. Beyond the language of icons is an example photograph, sculpture, music programs; in the language can be found in the image icons anomatope. Develop analysis and understanding by looking at the sign is an icon, index and symbol contained in the text, as well as the things that contain a language.

## RESEARCH METHODS

The results of this study using the method of observation and analyzed using Pierce semiotic studies (icon, index, symbol) based on culture values, ie by studying the *Ramayana Ballet* through books and watch the show to assess culture values contained in the *Ramayana Ballet* with semiotic studies.

## DISCUSSION

Ayodya kingdom held a contest for grab Shinta, beautiful woman king's sons. The competition was attended by many kings of various countries. When the competition takes place, there is no king who can win. Finally came the Rama and win the contest. Seeing beauty Shinta, evil Rahwana tried to have it. Various ways he did, to be able to bring Shinta to his kingdom. Thanks to the help marica disguised as golden deer, Rama cheats and Admiral. Shinta Rahwana kidnapped and ask to marry him.

### Culture Values

In *Ramayana* culture value in it in three states, namely ideas, actions, and artifacts.




### Performance Overview *Ramayana*



Episode 1	Episode 1: The loss of Shinta Consists of 3 rounds and detailed in 57 scenes.
Episode 2	Episode 2: Hanoman Duta burn state Alengka Consists of 7 innings and detailed in 71 scenes.

Episode 3	The death Kumbakarna Consists in 4 innings and detailed 42 scenes.
Episode 4	Episode 4: Proof of love sacred Shinta Consists in 4 innings and detailed in 48 scenes.

Before the start of the story is shown a procession of eight dancers dressed man Keraton Surakarta soldiers escorting seven female carrier offerings. After being in the middle of the stage floor, the soldiers will perform dance moves stout, while the female carrier offerings and incense offerings laying near the gamelan. The woman offering carrier will then be seated in between gamelan and continue the next task as a vocalist or waranggana, while the soldiers out stage.

Culture values in the staging of *Ramayana* is divided into three, namely: in the form of ideas, actions and artifacts. In assessing the value of this culture is used table analysis with semiotic study of Pierce. Based on the analysis conducted shows that there are 37 culture values on *Ramayana Ballet*. There are 16 icons, 11 indices, and 9 symbols depicted in the show. Based on the study found that culture values: 8 ideas, 21 action, and 12 artifacts that are used in this staging. Here are some sample images and analysis.

Visual	Culture Values Based Study of Semiotics
	The opening of this performance mastermind open <i>Ramayana Ballet</i> performances by wearing traditional Javanese clothes, wear blangkon, batik, and traditional Javanese clothes. Dalang open in front courtyard of the temple of Prambanan, it is an idea to start this staging. While the courtyard of the temple, used clothing, gamelan players an artifact, are objects into culture.
	In this scene Shinta bowed head, because he felt sad not get the golden deer. Rama Shinta in the forest entertaining Dandaka with lap and wipe the tears on the faces of Shinta. Marks contained in this scene is an index, because of the causality of sadness Shinta. It is included in the culture aspects of the form of action. Being a culture and obligation for a husband to protect her and comfort her.
	Rama wanted to capture the desired golden deer Shinta. It is an icon that indicates a sign of deer animal is made in the form of a beautiful, golden-colored dress and horns that resemble deer. This antelope wear anklets, as a sign of wonderful animals. Equipment used by deer and Rama is an artifact. Rama is carrying a bow and arrow, wearing crown and batik fabrics.

	<p>The scene is about Shinta who ordered Laksmana to help Rama in the forest Dandaka. Included in the symbols and culture values in the form of ideas. Because of the attitude of the feet and hands Lakshman showed execute commands from Shinta. Shinta hand gently lifted one and this leads to a symbol Lakshman told him to go. The idea contained in the form of Shinta thought to help her husband, and Laksmana had the idea to keep Shinta with magic circle that surrounds it from danger.</p>
	<p>Rahwana scene disguised as an elderly grandmother to deceive Shinta. Declare an act of culture symbols and values. Because attitudes toward elderly grandmother Shinta powerless to make compassion, this includes the mark. Shinta help old grandmother, a culture value that is done through action</p>

The table is part of culture value analysis table *Ramayana* assisted by Pierce semiotic studies.

### Episode 2: Hanoman Duta burn state Alengka

In this episode Hanoman Duta has come to Alengka country. There is a notion of culture values, as stated from the index mark. Index is seen that Hanoman would be burned, causing the incident as Rahwana find Hanoman will bring Shinta. Included in the culture in the form of ideas, because Rahwana wanted Hanoman burnt. But Hanoman Duta fight and burn Alengka kingdom, including the index mark (causation). Reason Hanoman Alengka royal burn, because the action Rahwana who want to burn him alive. The scene has a form of culture values in the form of action.

### Episode 3: The death Kumbakarna

Rama against Kumbakarna (Senopati Alengka) to save Shinta. There is a culture value to the form of action. Seen from the icons shown with Kumbakarna face red, red light stylist and she raised her hands to fight Rama. Position Rama who tried to avoid a form of culture values in the form of action.

The death angel picked Kumbakarna is a symbol that her spirit is picked up by the angels. Included in the form of culture values in the form of ideas, because each who died or dies characterized by picking his spirit by an angel.

### Episode 4: Proof of Love sacred Shinta

In this episode of Rama against Rahwana in Alengka kingdom. Included in the form of culture action, seen from the index marks contained in the incident. Rama came against Rahwana, because he has kidnapped his wife (Shinta). Therefore fighting. Culture manifestation in the form of the action is seen from the incident the battle between Rama and Rahwana. Finally Rahwana dihimpit Sumawana mountain.

Rama Shinta dubious sanctity who have lived in the kingdom Alengka. Form of culture values in the form of ideas, marked with the symbol. Because of doubts Rama, Shinta then burn her to prove her purity. Symbol of purity is expressed by burning themselves. If Shinta burned, signaling is not purified, but if Shinta survived the fire, indicating that Shinta is still sacred.

## CONCLUSION

Culture values are divided into three, namely: in the form of ideas, actions and artifacts. In assessing the value of this culture is used table analysis with semiotic study of Pierce. Based on the analysis conducted shows that there are 37 culture values on *Ramayana Ballet*. There are 16 icons, 11 indices, and 9 symbols depicted

in the show. Based on the study found that culture values: 8 ideas, 21 action, and 12 artifacts that are used in this staging. The use of red color worn for evil character figures, used by Rahwana figures, Trijata and figures of the royal Alengka. The use of gold used by the character well, there is the figure Shinta, Rama, Laksmana, and some other figures. Culture beauty of the show *Ramayana* is contained in the clothes worn are: cloth, scarves and hats, crowns, jewelry, anklet. It is a form of physical culture.

## BIBLIOGRAFI

- Cobley, Paul. 2001. *The Routledge Companion To Semiotics and Linguistics*. London: Routledge.
- Endraswara, Suwardi. 2011. *Metodologi Penelitian Sastra: Epistemologi, Model, Teori, dan Aplikasi*. Yogyakarta: CAPS.
- Herimanto dan Winarno. 2011. *Ilmu Sosial dan Budaya Dasar*. Cet. 4. Jakarta: Bumi Aksara.
- Ikram, Achadiati. 1997. *Filologia Nusantara*. Jakarta: Pustaka Jaya.
- Prasetya, Joko,dkk. 2009. *Ilmu Budaya Dasar*. Jakarta: Rineka Cipta.
- Setiadi, Elly M. dan Usman Kolip. 2013. *Pengantar Sosiologi (Pemahaman Fakta dan Gejala Permasalahan Sosial: Teori, Aplikasi dan Pemecahannya)*. Cet.3. Jakarta: Prenamedia Group.
- \_\_\_\_\_,dkk. 2009. *Ilmu Sosial Dan Budaya Dasar*, Ed. 2. Cet.5. Jakarta: Kencana
- Sayuti, Suminto A (Ed.). 2000. *Evaluasi Teks Sastra (terjemahan The Evaluation of Literary Texts)*. Yogyakarta: Adicita Karya Nusa.
- Semi, M. Atar. 1993. *Metode Penelitian Sastra*. Bandung: Angkasa.
- Sobur, Alex . 2001. *Analisis Teks Media*. Bandung: Remaja Rosdakarya.
- Sudjiman, Panuti dan Aart Van Zoest. 1992. *Serba-Serbi Semiotika*. Jakarta: Gramedia Pustaka Utama.
- Suratminto, Lilie. 2012. *Brandes Sang Penyelamat Manuskrip Nagarakretagama: Dilihat dari Batu Nisan melalui Kaca Mata Semiotik*. Vol.3. No. 2. Jakarta: Jumentara PNRI.
- Tumanggor, Rusmin,dkk. 2010. *Ilmu Sosial Dan Budaya Dasar*. Jakarta: Kencana Prenada Media Group.
- Widaghdho, Djoko,dkk. 2010. *Ilmu Budaya Dasar*. Cet.11. Jakarta: Bumi Aksara.
- Pradopo, Rachmat Djoko. 2001. *Metodologi Penelitian Sastra*. Yogyakarta: Hanindita.
- Zaimar, Okke K.S. 2008. *Semiotik dan Penerapannya dalam Karya Sastra*. Jakarta: Pusat Bahasa Departemen Pendidikan Nasional.
- <http://www.republika.co.id/berita/senggang/seni-budaya/12/10/16/mbytk-sendratari-ramayana-prambanan-raih-rekor-dunia>. Diunduh 15 Februari 2013.
- <http://marianowhokki.blogspot.com/2011/02/sendratari.html/>. Diunggah pada hari Selasa, 22 Februari 2011. Diunduh 22 Maret 2013.

## **BEHAVIOR OF WOMEN CHILD-BEARING AGE EFFORTS OF BREAST SELF-EXAMINATION IN EARLY DETECTION OF BREAST CANCER IN THE MANDALA VILLAGE OF NORTH JAYAPURA, INDONESIA**

*<sup>1</sup>Galio Rudolfo Dian Burdames<sup>1,2</sup> Maria Hukubun Yane Tambing<sup>3</sup>  
Health Promotion, University of Cenderawasih, Jayapura, Papua, Indonesia,  
Health Promotion, faculty of Public Health, University of Indonesia, Depok, Indonesia*

**Keywords:** Knowledge, Attitude, Practice, Breast Self-Examination, Breast Cancer

**Introduction:** Breast cancer is a cancer derived from cells contained in the breast. The adult women tended to do examination before complex cancer symptoms appear and already in an advanced stage, making it more difficult for the healing process. Visiting rates in the Dok Dua Hospital in 2005 to 2011 was 465 patients and at the rate of 40% of visiting came from North Jayapura area. Breast Self- Examination is a health promotion method because it is addressed for person in good health through prevention of exposure to breast cancer various risks. The absence of relevant research for this Behavior in Papua, still limited to the hospitality that needs to be done in a community.

**Methods:** This research using descriptive Approach which is use depictions of the frequency distribution, respondents were taken by simple random sampling technique by means of raffle for women of child-bearing age who live in the Mandala Village of North Jayapura with 93 respondents. Data collection techniques used questionnaires to determine the knowledge, attitudes and practice.

**Results:** showed knowledge about Breast Self -Examination, including both 47 (50.2%), while a good attitude towards including 59 (63.4%) and low action against, including 77 (82.8%). Based on these results need to disseminate information about important benefits and ways of Breast Self Examination.

**Discussion:** breast self-examination is a health promotion method or primary prevention to early detect early symptoms of breast cancer. practices of women of child-bearing age should be increased to be able to make the better health behavior.

### **Introduction**

Breast cancer is a malignant tumor derived from cells contained in the breast. The breast consists of lobules-lobules, ducts, fatty and connective tissue, blood vessels and lymphatics. Breast cancer is the second most common cancer after cervical cancer in Indonesia (Tjindarbumi, 2007).

It is important to note, that the initial lump growing in female breast tumors or cancer can be said after the clinical examination. From 1988 to 1992, the malignancy of cancer in Indonesia is not much changed. Cervical cancer and breast cancer remains a top priority. In addition to a number of cases, more than 70% of breast cancer patients are found in advanced stages (Moningkey, 2010).

Public awareness to perform BSE quite high in developed countries, so that new cases have be known early on. While in Indonesia, approximately 65% came to the doctor at an advanced stage. Based on data from the Dok II Hospital, Jayapura, showed that 40% of breast cancer patients visits originating from the region of North Jayapura District (Hospital Medical Record. Dok II Jayapura, 2012). This figure does not rule out the information about the tumor or cancer is not fully reach urban communities.

North Jayapura District has 7 village and one village, one of which is the Village Mandala. Mandala Village chosen as the study site because of entry in Urban area (urban), which has had a pluralistic society and a high mobility rate (Papua Knowledge Center, 2011). Based on the above background, the researchers interested in conducting research in the Village Mandala Jayapura District North. With the aim to Know Behavior picture women of childbearing age about BSE in the early detection of breast cancer in the Village of North Mandala Jayapura District.

## Materials and Methods

The research was conducted from May to June 2013, the type of research that is used for this research is a descriptive study using cross sectional approach was to describe the behavior of women of childbearing age about Breast Self Examination in the early detection of breast cancer in the Village Mandala North Jayapura District Population living in kelurahan Mandala as many as 1,421 people. The sample of this study were women of fertile age woman who lived in the village Mandala of 93 respondents.

Woven of Child Bearing Age Knowledge About Realize By knowing the behavior of three domains, namely knowledge, attitudes and Practice. Woven of Child Bearing Age knowledge is understanding the respondents in explaining about things related to understanding breast cancer, causes of breast cancer, symptoms of breast cancer, breast cancer risk factors, prevention of breast cancer, the benefits of BSE, the treatment of breast cancer and Breast Self Examination. The attitude was expression of Woven of Child Bearing Age about breast cancer efforts, causing breast cancer, symptoms of breast cancer, breast cancer risk factors, prevention of breast cancer, the benefits of Breast Self Examination, the treatment of breast cancer and Breast Self Examination. The act was an act which done by Woven of Child Bearing Age associated with BSE (Breast Self Examination). Measurement Knowledge scale will be assessed when Well, if the respondent answered correctly > 76% and Low if the respondent answered <39%. For variable attitudes Well said, if the respondent answered correctly >76% Low, if the respondent answered <39%. For variable actions Well, if the respondent answered correctly > 80% and Low if the respondent answered <79%.

Data were collected using a questionnaire containing questions about knowledge, attitudes and Practices about BSE and Breast Tumors. Secondary data was also used, data used to supplement or support the primary data, such as documentation, literature or previous scientific journals that are still relevant to the issues discussed, the data from Papua Knowledge Center, Indonesian Cancer Foundation (ICF) Papua region, all hospital at Jayapura area.

Primary data was obtained data directly from survey respondents through interviews using questionnaires to respondents.

## Results

### a. Women Child Bearing Age Knowledge About BSE

Table 4.9: Distribution of Sample Based in Knowledge of The Mandala Village North Jayapura District

No.	Knowledge	Amount	%
1	Very Good	9	9,7
2	Good	48	51,6
3	Less Good	31	33,3
4	Poor	5	5,4
<b>Total</b>		<b>93</b>	<b>100.0</b>



Table 4.9 shows that, the samples have very good knowledge about 9 samples (9.7%), the sample has a good knowledge of as many as 48 samples (51.6%). samples which have poor knowledge of as many as 31 samples (33.3%), and samples have bad knowledge by 5 respondents (5.4%).

### **b. Woven Child Bearing Age Attitudes About BSE**

Table 4.13: Distribution of Sample Based on the attitude of the mandala Village of North Jayapura District

No.	Attitudes	Amount	%
1	Very Good	41	44.1
2	Good	52	55.9
3	Less Good	0	0.00
4	Poor	0	0.00
<b>Total</b>		<b>93</b>	<b>100.0</b>

Table 4.13 shows that, most of the respondents who have a good attitude that 59 respondents (63.4%), while respondents who have a poor attitude as much as 34 respondents (36.6%), and respondents who have a very good attitude and low no.

### **c. Women Child Bearing Age Practice About BSE**

Table 4:17: Sample Distribution Based on actions in the Mandala Village of North Jayapura District.

No.	Practice	Amount	%
1	Good	16	17.2
2	Less	77	82.8
<b>Total</b>		<b>93</b>	<b>100.0</b>

Table 4:10 shows that, most of the samples that have less action as much as 77 samples (82.8%), and samples with good action as much as 16 (17.2%).

## **Discusion**

Knowledge of women of childbearing age about breast cancer and BSE as early detection with sample categories have a good knowledge of 48 respondents (50.5%), while the category of samples that have low knowledge as much as 5 (5.4%) samples.

Women of childbearing age are becoming more samples from among housewives as many as 33 respondents (35.5%). Knowledge plays a very important in making a decision. in Notoadmodjo (2003), based on the knowledge that the behavior will be more of an impact on the propensity to behave and act. Most of the sample answered questions on the variables of knowledge, but there are some questions that have not been known to affect the sample so that the answers given, in general, the sample did not know the stages of BSE and also a good time to do a breast self-exam. Respondents generally do not know the right time to do BSE is only a fraction that can answer correctly. Questions about the stages of BSE is also much that is not known by the sample.

Attitude is the first step to act or behave open (action). WUS has a good attitude as much as 52 samples (55.9%). The very basis of the number of samples based on answers to questions is that they understand the importance of breast self-examination. Based on the results of the cross table shows that the attitude of the highest in the age group 15-21 years as many as 12 samples (12.9%) considered very good. 29-35 years age group by 10 samples (10.8%). It shows the two age groups are productive age someone where an increase in knowledge.

The more you get older it is the power to think and decide something stronger.

The action is real action of knowledge and attitudes. Measures samples in the Mandala Village of North Jayapura District well as 16 samples (17.2%). Most of the sample of 77 samples (82.8%) less action that

is not behaving in accordance with the knowledge and confidence that is not the real action that is performed by the sample.

Based on BSE behavior very less research lays back in performing BSE for early detection, and perform BSE regularly every month, and the stages of BSE where most mengku not perform BSE in accordance with the stages.

The behavior of women of childbearing age about knowing in early detection of breast cancer were studied in the Village Mandala, North Jayapura District categorized less.

needed to boost the knowledge, attitudes and behavior of women of childbearing age through education about the dangers of breast cancer and how early detection with BSE in order to increase the understanding and behavior of people, especially women of childbearing age can be changed as well as the increased level of health for women of childbearing age.

## **Acknowledgments**

We thank lecturers and all parties for valuable input during the data abstraction and analysis phase of this study.

## **Disclosure Statement**

The authors have no conflicts of interest to report.

## **References**

- Arikunto, S. 2002. Research Procedures. A Practice Approach. Jakarta: Rineka Reserved
2008. Class Action Research. London: Earth Literacy
- Bustan, 2007. Epidemiology of Communicable Diseases. Jakarta: Rineka Reserved
- Cancershelp. 2012. Breast Self Examination: How to Perform breast Self-Exam  
Retrieved from <http://www.cancershelp.com> On Date March 16, 2013
- Danielle, G, 1999. The Oncology Nursing care plan. Jakarta: EGC
- Husaini, S.1995. Methodology of Social Research. London: Earth Literacy
- Kusmiati. 1990. Behavior Basics. Jakarta: Bakti Husada
- Mansjoer, A, 2000. Capita Selecta Medicine. Jakarta: Aescucalipus
- Moningkey.2000. Epidemiology of Breast Cancer. In: Pane. M. Clinical and Epidemiological Aspects of Breast Cancer. Jakarta: Medical
- Notoatmodjo, S. 2005. Health Research Methodology. Jakarta: Rineka Reserved
2007. Health Promotion and Behavioral Sciences. Jakarta: Rineka Reserved
2009. Human Behavioral Sciences. Jakarta: Rineka Reserved
- Niken, R. 2012. Recognize Early detection of breast cancer. Accessed From  
<http://www.health.okezone.com> On December 5, 2012
- Papua Knowledge Center. 2011. Village Mandala Jayapura District North. Accessed December 20, 2012  
At the date of <http://papuaknowledgecenter.org/areas/view/343>
- Purwanto. 2007. Quantitative Research Methods. Style Media. Jakarta

Rayburn. 2009. *Obstetrics and Gynecology*. Jakarta: Widya Medical

Siswanto, W. 2008. *Women's Health*. DIY. UGM

Sandjaja, B. 2011. *Cancer in General Hospital and Private Hospital*. Papua. ICF

Soelarto. 1995. *Surgery set Lecture Faculty of medicine / RSCM, Binarupa Literacy*, Jakarta

Sri, U. 2009. *Overview Knowledge, Attitudes and Behaviour of Young Women Against Breast Self Examination*. Jambi. POLTEKKES

Sutjipto. 2009. *Problems Early detection and treatment of breast cancer*. Retrieved from <http://www.dharmais.co.id> In Date December 15, 2012

Tambunan. 1995. *Diagnosis and Management 10 Types of Cancer Highest in Indonesia*. Rineka Copyright: Jakarta.

Tjindarbumi. 1997. *The discovery of Early Cancer And Its Remedies*. Jakarta.FKUI

UICC. 2012. *Symposium On Breast Cancer Prevention: Models For Breast Cancer Breast Cancer Prevention From Innovation To Action*. Accessed From <http://www.uicc.org> On 02 January 2013

Wijaya. 2010. *Killer Named Malignant Cervical Cancer*. Rays Morning: Yogyakarta

## **CHARACTERISTICS OF PERINATAL WHO DIED IN PIRNGADI GENERAL HOSPITAL MEDAN INDONESIA**

**Cempaka Rini<sup>1,2</sup>,**

<sup>1</sup>Epidemiology, Faculty of Public Health, University of North Sumatera, Medan, Indonesia.

<sup>2</sup>Health Promotion, Faculty of Public Health, University of Indonesia, Depok, Indonesia.

Email : [cempakarini@yahoo.com](mailto:cempakarini@yahoo.com) or [cempakarini87@gmail.com](mailto:cempakarini87@gmail.com) Mobile : 085262647035

### **ABSTRACT**

Perinatal mortality has an important role in providing the information needed to improve the health status of pregnant women, maternal and newborn infant. In 2004, perinatal mortality rate in the world is 43/1000 births, 47/1000 births in Asia and 21/1000 births in Indonesia. This study was descriptive study approach by using case series. The population of this study were 154 cases of all perinatal mortality data which registered in DR. Pirngadi Hospital Medan since 2007 until 2008. Sample was total sampling. This study shows that highest proportion of perinatal mortality characteristics of the deceased: high-risk birth weight (65.6%), diseases disorders infants (75.3%) and asphyxia (78.9%) .

There were significant differences between birth weight infants ( $p= 0.002$ ), disease infants ( $p = 0.000$ ) based on the type of perinatal mortality. In addition, there were significant differences of average length of stay based on birth weight ( $p=0,000$ ) and baby's disease ( $p=0,000$ ). It is recommended that DR. Pirngadi Hospital, Medan will improve medical record filling and registration. It might be needed to improve the quality of service to patients especially newborns in order to survive longer.

**Key words** : perinatal mortality, infant characteristics, descriptive studies, DR.Pirngadi hospital Medan

## **BACKGROUND**

Health development as an integral part of national development seeks to improve the quality of health of the population to achieve increased productivity and well-being of the nation. Efforts to improve the human quality that should be done early is highly dependent on the health of mothers who conceived and health in childhood, the foundation for the future life of the human being further<sup>1</sup>

Perinatal death has an important role in providing the information needed to improve the health of pregnant women, maternal and newborn infant. Perinatal death means the number of stillbirths and infant deaths within the first 7 days on his life<sup>2</sup>

SKRT 2001 showed a major cause of perinatal mortality are birth asphyxia 34%, 33% low birth weight and prematurity, congenital abnormalities of 4%, which affects fetal maternal health by 3% and others 26%<sup>3</sup>.

WHO Report in 2004, perinatal mortality rate in the world 43/1,000 births, of which 98% of perinatal mortality occurred in developing countries. Perinatal mortality rate in Africa 56/1,000 births and in Asia 47/1,000 births, while in Europe 8/1,000 births<sup>4</sup>.

Indonesia Demographic Health Survey in 2002-2003 showed the infant mortality rate (0-12 months) 35/1,000 live births and infant mortality rate (0-60 months) 46/1,000 live births, while the neonatal mortality rate (0-28 days ) of 20/1,000 live births<sup>5</sup>. Based on the WHO report in 2000 perinatal mortality rate in Indonesia 30/1,000 births and decreased in 2004 to 21/1,000 births. Meanwhile, according to Indonesia's Health Profile in 2005 the Ministry of Health reported the perinatal mortality rate in-hospital hospital in Indonesia (1268 hospital) is 49.33/1,000 births<sup>6</sup>.

National Health Survey in 2001, the main causes of infant mortality is perinatal mortality of 34.7%. Based on the report of 2007 Directorate General of Medical Care causes of infant mortality in North Sumatra no specific survey data that support, but as a comparison, the national cause of death was due to slow fetal growth, fetal malnutrition, prematurity and low birth weight by 38,94%<sup>7</sup>.

Investigation of perinatal mortality in some hospitals in Indonesia showed that the factors influence perinatal mortality are maternal factors and infant factors the perinatal mortality rate.

## **RESEARCH METHODS**

This study was a descriptive study using a case series. The population in this study is all the data recorded in the report of Dr. Pirngadi Hospital field in 2007-2008, amounting to 154 cases. The sample in this research is all the data perinatal death are recorded in the report of Dr. Pirngadi Hospital field in 2007-2008 with the sample size is equal to the population (total sampling).

Data collection was done by taking the secondary data obtained from perinatal status card that died derived from medical records Dr. Pirngadi Hospital field in 2007-2008, then recorded and tabulated according to the variables to be observed.

Univariate analysis were analyzed by descriptive and bivariate analysis were analyzed using chi-square and t-test.

## **RESULTS AND DISCUSSION**

In 2007 at Dr. Pirngadi Hospital Medan obtain the number of perinatal deaths 76 cases of 855 births (perinatal mortality rate 88.89 per 1,000 births). Whereas in 2008 obtained 78 cases of perinatal deaths of 937 births (perinatal mortality rate 83.24 per 1,000 births).

## 1. Characteristics of the Perinatal Infant Death

**Tabel 1**  
**Proportion Distribution Characteristics of the Perinatal Infant Deaths in Dr. Pirngadi Hospital Medan Year 2007-2008**

No.	Infant characteristics	Total	
		F	%
1.	Birth weight		
	high risk	101	65,6
	low risk	40	26,0
	not recorded	13	8,4
	Total	154	100
2.	Diseases /Disorders baby		
	There are diseases/ disorders	118	76,6
	No disease	36	23,4
	Total	154	100
3.	There are diseases/ disorders		
	Asphyxia	93	78,9
	Apnea Prematurity	14	12,0
	Tetanus Neonatorum	2	1,7
	Multiple organ system disorders	2	1,7
	Sepsis	2	1,7
	Heart Failure	1	0,8
	Neonatus Aterus	1	0,8
	Cepal Hematoma	1	0,8
	Neonatal Seizure	1	0,8
	More than 1 diseases disorders	1	0,8
	Total	118	100

From table 1, the proportions characteristic of perinatal infants who died was higher in infants with a birth weight of 65.6% high risk, and there are diseases/diseases disorders infants 76.6% of 118 infants who had the disease / disorder is the highest proportion of asphyxia at 78.9% and the lowest was heart failure, neonatal aterus, cepal hematoma, neonatal seizures, more than one disease / disorder respectively by 0.8%. This is consistent with studies Mortality Survey 2001 showed a major cause of perinatal death was asphyxia (respiratory failure) 34%<sup>3</sup>.

## 2. Distribution The proportion of type Perinatal Mortality

**Table 2**  
**Distribution of the proportion of type Perinatal Mortality in Dr. Pirngadi Hospital Medan 2007-2008**

Type Perinatal Death	Total	
	F	%
Stillbirth	36	23,4
Early neonatal death	118	76,6
Total	154	100

Table 2 showed that the proportion of perinatal mortality was higher in the early neonatal mortality 76.6% instead of 23.4% stillbirth.

### 3. Average Length of Stay Perinatal Death

**Table 3**  
**Average Length of Stay Perinatal Death in Dr. Pirngadi Hospital Medan 2007-2008**

Average Length of Stay	
Mean	2,130
Standard Deviation	1,481
95 % CI	1,89-2,37
Coefisien of Variation	69,53%
Minimum	1
Maksimum	7

Based on Table 3 above, that the average long perinatal care who died in RSU Dr. Pirngadi field in 2007-2008 was 2.13 days (2 days), Standard Deviation = 1.481 and the value coefisien of Variation is 69.53% which means that the average length of stay treatment of perinatal death vary. Length of stay treatment at least 1 day, and a maximum of 7 days. Based on the 95% confidence interval obtained an average length of stay of perinatal death was from 1.89 to 2.37 days.

### 4. Statistical analysis of death infants characteristics by type of perinatal mortality

**Table 4**  
**Statistical analysis of perinatal death characteristic (birth weight, disease/disorder) by type of perinatal mortality**

type of perinatal mortality	birth weight				Total	
	High Risk		Low Risk			
	F	%	f	%	f	%
Stillbirth	16	50,0	16	50,0	32	100
Early neonatal death	85	78,0	24	22,0	109	100
$\chi^2 = 9,531$ $df = 1$ $p = 0,002$						
type of perinatal mortality	disease/disorder				Total	
	Have		Nothing			
	f	%	f	%	f	%
Stillbirth	0	0	36	100	36	100
Early neonatal death	118	100	0	0	118	100
$\chi^2 = 1,540$ $df = 1$ $p = 0,000$						

Based on Table 4 above, 32 infants who experienced stillbirth, birth weight infants with high risk and low risk of having a proportion of 50%. Of the 109 infants with early neonatal mortality, higher birth weight infants with high risk by 78% than the proportion of infants of low birth weight risk with the proportion of 22%.

Statistical analysis using the chi-square test was obtained values of  $p < 0.05$ . This means that there is a statistically significant difference between the proportion of birth weight infants by type of perinatal death.

This is consistent with the theory that the risk factor in the fetus and infants can enhance the perinatal mortality among other infants with birth weight <2500 grams due to the baby's vital organs are not functioning perfectly and infants with birth weight > 4,000 grams cause the baby is difficult to remove from his mother's womb so that prolonged delivery and heightens the risk of asphyxia<sup>8</sup>

The results are consistent with research conducted by Manandhar SR, et al in Kathmandu Medical College Hospital (2003) with a cross-sectional design, which get the highest proportion of perinatal mortality in high-risk birth weight of 70.5%<sup>9</sup>.

Of the 36 infants who experienced stillbirth, all babies no disease / disorder in the proportion of 100%. Of the 118 infants with early neonatal death, all the babies there are diseases / disorders in the proportion of 100%.

Statistical analysis using the chi-square test was obtained values of  $p < 0.05$ . This means that there is a statistically significant difference between the proportion of diseases / diseases disorders infants by type of perinatal death.

Wiknjosastro said that the factors that enhance infant perinatal mortality rate among them is a baby who was born with a disease / congenital abnormalities<sup>8</sup>. The results are consistent with research conducted by Andriyani in Hospital St. Elisabeth Medan (2004-2007) with a case series design, which get the highest proportion of perinatal mortality in infants who have a disease / congenital abnormalities at 71.8%<sup>10</sup>

### 5. Average Length of Stay Perinatal Death Based on Birth Weight

**Tabel 5**  
**Average Length of Stay Perinatal Death Based on Birth Weight Recorded in Dr. Pirngadi Hospital Medan 2007-2008**

Birth Weight	Length of Stay (Days)		
	N	Mean	SD
High Risk	101	2,24	1,569
Low Risk	40	1,75	0,954

Research results in Table 5 that the average Length of Stay perinatal death with high-risk birth weight was 2.24 days (2 days), and the average perinatal care who dies with low risk birth weight was 1.75 day (2 days).

Statistical analysis using the t-test is obtained values of  $p < 0.05$ . This means that there are statistically significant differences between the average long treatment perinatal death by birth weight. High-risk birth weight longer treated (2.24 days) of low risk birth weight (1.75 days).

### 6. Average Length of Stay Perinatal Death Based on infant disease/disorder

**Tabel 6**  
**Average Length of Stay Perinatal Death Based on infant disease/disorder in Dr. Pirngadi Hospital Medan 2007-2008**

infant disease/disorder	Average Length of Stay		
	N	Mean	SD
disease/disorder	118	2,47	1,534
no disease/disorder	36	1,00	0,000

Based on Table 6 it can be seen that the average long perinatal care who died with the disease/ disorder in infants was 2.47 days (3 days), and the average treatment perinatal death in the absence of disease/disorder in infants is 1 days. Statistical analysis using the t-test is obtained values of  $p < 0.05$ . This means that there are statistically significant differences between the average long treatment perinatal death by disease / disorder baby. Infants with the disease / disorder longer treated (2.47 days) than infants who no disease / disorder (1.00 days)

Treatment of 1 day old tends to occur in infants who have the disease / disorder, while the 7-day long treatment with regard to the condition of the baby at birth with birth weight  $< 2500$  g or  $> 4,000$  grams, and the presence of diseases/disorders infants, as well as at the time of receiving the referral state



the baby is not in a state optimal. The results are consistent with research conducted by Andriyani in Hospital St. Elisabeth Medan (2004-2007) with a case series design, which get longer average Length of Stay perinatal death was 1.79 days (2 days)<sup>10</sup>.

## CONCLUSION

1. Baby's characteristics were male, high risk of birth weight and baby disease or disorder presence have the higher risk of perinatal death rate, 50.6%, 65.6% and 76.6% respectively.
2. Type highest perinatal mortality is early neonatal mortality with the proportion of 76.6%
3. Average Length of Stay treatment duration of perinatal care who died in RSU Dr. Pirngadi Medan of 2.13 days.
4. There were significant difference between birth weight ( $p=0,002$ ), infant diseases ( $p=0,000$ ) in the perinatal mortality type in Pirngadi General Hospital Medan
5. There is a significant difference in the average treatment time is based on birth weight in RSU Dr. Pirngadi Medan
6. There is a significant difference in the average treatment time is based on based on the baby's disease in RSU Dr. Pirngadi Medan

## SUGGESTION

1. It is recommended that DR. Pirngadi Hospital, Medan will improve medical record filling and registration.
2. It might be needed to improve the quality of service to patients especially newborns in order to survive longer

## REFERENCE

1. Barus, N., 1999. **Tantangan dan Masalah dalam Upaya Penurunan Resiko Kematian Ibu dan Neonatal Menyongsong Era Globalisasi**. Pidato Pengukuhan Jabatan Guru Besar Tetap Dalam Ilmu Kesehatan Masyarakat Pada FKM USU, Agustus 1999
2. WHO, 2004. **Neonatal and Perinatal Mortality**. <http://www.who.int>. diakses 29 Januari 2009.
3. Sulistiyowati, N., dkk., 2003. **Beberapa Faktor Yang Melatarbelakangi Kematian Perinatal Di Kota Bekasi Tahun 2003**. <http://www.ekologi.litbang.depkes.go.id>. diakses tanggal : 15 Januari 2009.
4. WHO, 2006. **Monitoring and Evaluation (MAE)**. <http://www.who.int>. diakses tanggal 29 Januari 2009.
5. Sulani, F., 2008. **Upaya Akselerasi Penurunan Angka Kematian Dan Peningkatan Kualitas Hidup Anak Indonesia**. [http://www.depkes.go.id/data\\_perencanaan/Banjarmasin/KebijakanPenurunanKematianBinkesAnak20JulBanjarmasin.ppt](http://www.depkes.go.id/data_perencanaan/Banjarmasin/KebijakanPenurunanKematianBinkesAnak20JulBanjarmasin.ppt). diakses tanggal : 15 Januari 2009.
6. Departemen Kesehatan RI, 2006. **Profil Kesehatan Indonesia 2005**.
7. Departemen Kesehatan RI, 2008. **Profil Kesehatan Provinsi Sumatera Utara Tahun 2007**.
8. Wiknjosastro, H., 2006. **Ilmu Kebidanan**. Penerbit Yayasan Bina Pustaka Sarwono Prawirohardjo, Jakarta.
9. Manandhar, S.R., dkk, 2003. **One Year Audit of Perinatal Mortality At Kathmandu Medical Collage Hospital**. Kathmandu University Medical Journal 2003, Volume 2, No. 3. <http://www.kumj.com>. diakses tanggal : 6 Juni 2009.
10. Andriyani, D., 2008. **Karakteristik Kematian Perinatal Di RS St. Elisabeth Medan Tahun 2004-2007**. Skripsi FKM USU.

## DRUG ADDICT, CAN IT BE CURED IN MALAYSIAN CONTEXT?

Huzili Hussin<sup>1</sup>, Nor Syamimi Mohamed Adnan<sup>2</sup>, NurSalimah Alias<sup>3</sup>, Mohamad Hashim Othman<sup>4</sup>, Abd. Majid Mohd Isa<sup>5</sup>, Kamarudin Hussin<sup>6</sup>, NorAzmah Karim<sup>7</sup> & Ku Azira Ku Aziz<sup>8</sup>

Universiti Malaysia Perlis<sup>1,2,3,5,6,7,8</sup>  
University Sains Malaysia<sup>4</sup>

### Abstract

Drug addiction manifests as a compulsive drive to take a drug despite serious adverse consequences. This aberrant behaviour has traditionally been viewed as bad 'choices' that are made voluntarily by the addict. People perceived that drug addiction cannot be cured because it seems that individuals who are drug addict are losing their rationality to think as well as their self control. Moreover, this perception lead to stereotype where people believe all the society problem is cause by drugs addict. However, there are various types of treatment and an approach using a right cumulative length of treatments and suitable interactions with the respondent's based on the drug use patterns and the their history. Furthermore, there is a lot of effort that have been done by government in order to helps drugs addict and in some cases prove that drug addict can be a normal person back. Therefore, the purpose of this study is to investigate the effectiveness of approaches and treatments of drug addicts in Malaysia. The meta analysis was used in this study by critically review previous research, journals, articles, book and data. As a result, treatments used in Malaysia can help drug addicts to regain their self control as well an initial point for them to be cure. However, this curing process would be more effectives with the contribution and support by the social.

**Keywords:** *addiction, treatment, drugs*

### Introduction

Drug addiction is a complex issue and has been a serious public health problem in Malaysia. It is a complex illness characterized by intense and, at times, uncontrollable drug craving, along with compulsive drug seeking and use that persist even in the face of devastating consequences. Drug addictions has been said to begin with the voluntary act of taking drugs, over time a person's ability to choose not to do so becomes compromised, and seeking and consuming the drug becomes compulsive. If a person is dealing with pain-management issues, the drug they receive, can be very addictive. The ignorance of the drug's addiction potential, along with the physical pain of the condition, becomes a cause of drug addiction.

The effects of drug addiction are felt by the addicted person physically and psychologically. The effects are also seen in those around the addict, like family members and society. An effect of drug addiction is like a cycle where anytime the addicted person encounters stress or pain, they will feel like they need to use the drug. This is one of the psychological effects involved into the "craving" of the drug. Craving to drugs is an effect of drug addiction whereby the addict is obsessed with the effect of using the drugs, to the exclusion of all else. One of the psychological effects of addiction involved in craving is the belief the addict cannot function or handle life without using drug.

There are also physical effects of the drug addiction. It will affect the overall system of the body. The most seen effect of drugs addition is in the brain. Drug addiction changes the way the brain functions and impacts how the body feel pleasure. The drugs take control of the brain by flooding the brain with the chemicals name dopamine and serotonin. The brain adapts and comes to expect, and depend on, these drug-induced highs.

Since the drug control brain functions with chemicals, the society perceived that drug addiction is incurable because it seems that people who are addicted to drugs is easy to lose their rationality to think and also self control. Actually, drug addiction can be cured, but it was not easy. Effective treatment programs typically incorporate many components, each directed to a particular aspect of the illness and its consequences. People cannot simply stop using drugs for a few days and be cured. Most drug addict require long-term or repeated story of care to achieve the ultimate goal to their life recovery. There are various treatment and approach using a right cumulative length of

treatments and suitable interactions with the respondent's based on the drug use patterns and their history.

The purpose of this study is to investigate the effectiveness of approaches and treatments of drug addicts in Malaysia. Approaches made by the government by treatment and rehabilitation program, and medication by drug substitution were discussed in this paper.

## **Drug scenario in Malaysia**

Since the year 1970, when the maiden attempt to identify drug abusers was conducted, the number of these abusers has been swelling. A total of 711 addict were identified in 1970, 10, 661 in 1980, 16,893 in 1990 and a total of 31, 893 in 2002. (Mahmood Nazar, 2003). According to the National Anti-Drug Agency (2008), statistics in 2001-2008 showed a total of 221, 514 cases of drug addiction, including the new and the recurring cases. Although the number of cases in 2008 were reduced by 37.6% to 12,352 as compared with 32,808 cases in 2005, but an average of 16 new drug and 18 relapse cases detected each day showed the issue remains a concern. In addition, data relating to the causes of drug addiction during the period of 2001-2008 showed an average of more than 55% of cases due to peer pressure and more than 5% caused by stress (AADK, 2008). This means that most addicts face the problem of low self esteem and the influence of high external locus of control. Symptoms of drug addiction has also spread to the Institute of Higher Learning (IHL). According to research conducted by Kamarudin, Abd.Majid, Abdull Halim, Huzili&Mohd.Amran (2005), found 0.02% (2 in 1000) of first year students in institutions of higher learning are positive for drugs. In fact, the study also shows indirectly the first year students are also at high risk of symptoms of drug abuse as only a total of 1893 (53.3%) knew of the dangers of four of the nine types of commonly abused drugs and a total of 595 (16.8%) had known to be taking at least one of the nine of drugs commonly abused. This shows that prevention and enforcement by the IHL should be increased to safeguard the future leader.

## **Literature Review**

In the year of 1988 until 2006, there were cumulatively 300,241 registered drug addicts in Malaysia, constituting 1.1% of the general population. In 2006 itself, 22,811 drug addicts were detected in Malaysia. There were Malay ethnic group and consisting of 97.97% males and 69.48% females. The cumulative number of registered drug users until 2008 was estimated at about 250,000 and was predicted to reach half a million by 2015 (Rusdi et. al, 2008). In 2009, for every 20 new cases of drug abusers reported daily in average; there were concurrently 24 cases of relapse detected on the very same day (AgensiAntidadahKebangsaan, 2009).

There are many types of drugs that have been used by these drug addicts. The most used in Malaysia are Heroin which is 60.73% and followed by the cannabis which is 23.12%. Amphetamine Type Stimulants (ATS) is the third most used drug which is 14.34%. In terms of seizures a total of 155.73kg of heroin, 2, 378.81 kg of cannabis, 0.52 kg of opium, 145.56 kg of methamphetamine, 10, 803.25 liters of codeine, 263, 030 ecstasy pills, 198, 689 psychotropic pills, 191.21kg of ketamine, 2.22kg of cocaine, 125,019 Eramin 5 pills, 5, 093.59kg of Mitragyna and 242, 732 Yaba pills were seized (National Drug Information System, January, 2007).

Addicts in Malaysia are usually categorized into two types the mild addicts and hardcore addicts. Hardcore addicts are those who use the drug for over 10 years and had received treatment more than twice in the drug rehabilitation center. While mild refers to drug addicts using the drug for a short period of time and not treated or treated for the first time. (Mahmood Nazar, 1999).

In general, the cause of drug addictions are caused by several reasons. However, they could not get rid of it solely due to withdrawal syndrome. For example, the use of heroin will cause the withdrawal syndrome within 4-6 hours after the last dose. Addicts may experience symptoms such as diarrhea, abdominal pain, feeling cold, sweating, nausea, feelings of anxiety and fear. These symptoms will peak after about 24 hours to 72 hours. They would also have a problem to sleep and prolonged feelings of anxiety for no apparent reason. All these symptoms can only be eliminated by reusing heroin (Mahmood Nazar and Md. Shuaib, 2003). This withdrawal syndrome has lead to the ineffectiveness of any treatment program undergone by the drug addicts.

The findings of this research is advantageous to the government, namely the Home Ministry, NADA, social workers, drug counselors, psychologist and other human services in particular, Malaysia and other regions in general.

## **Research Methodology**

The meta analysis was used in this study by critically review previous research, journals, articles, book and data. Meta-analysis is a statistical method for pooling the results of several studies reporting the same outcome, in order to gain a better estimate of the effect size of an intervention.

## **Facilities in Malaysia**

In order to investigate the effectiveness of approaches and treatments of drug addicts in Malaysia, it would be useful to first look specifically the treatment and rehabilitation program conducted by the government in the country.

The national treatment and rehabilitation program is based on an institutional concept and is managed by the government. There are 29 treatment centers in Malaysia. B.Vicknasingam and Mahmud Mazlan (2007) said that there are currently there are three main treatment modalities. There are cold turkey detoxification in the institution, institutional rehabilitation for two years time and aftercare supervision for a period of between one to two years. According to them, if an individual is determined a drug addict, he is mandated to undergo compulsory government treatment and rehabilitation program.

According to Mahmood Nazar and Muhammad DzahirKasa (2007), in 1996, there were 48,216 drug users who were receiving rehabilitation. A total of 14,264 were placed in government rehabilitation centres; 9,107 inside correctional facilities and 24,845 in community programmes run privately by NGOs or by religious organizations (Ismail, 1998). In 2006, 5,148 drug addicts who received treatment were in government rehabilitation centres, 37,283 were in community-based programmes, 17,782 in the prison system and 6,662 in private centres.

Psycho social approaches are used in the treatment. However, this institutional treatment and rehabilitation program, which emphasizes a total abstinence approach, has proven to be not successful. Relapse rates within the first year following discharge are reported to be high ranging from 70 to 90% (Mahmud Mazlan et al, 2006).

## **Why drug addiction cannot be cured in Malaysia**

Attitude and poor knowledge on drug abuse been reported to be one of the failure factor (Abdullah & Iran, 1997). Besides, less support from family members and the community by large towards former addicts highly promote the effort to cure drug addiction (Brown et al., 1995; Miller et al.,1999; Miller, 1992; Moos & King, 1997). Research by MohdTaib, Rusli and MohdKhairi (2000) on family communication patterns among addicts' family and non addicts' family, showed weak communication patterns and less effective interactions among former addicts' family is one of the high probable factors toward drug addiction. Mahmood, et al. (1999) found 50% of old friends influenced former addicts to pick up the drug taking habit after they were discharged from rehabilitation centres. The research also showed that 76% of the old friends assist rehabilitated individuals to get the needed supply of drugs. These situations has lead to the failure of curing the drug addiction. Mc Coy and Lai (1997), on the other hand, associates inability to get jobs amongst former addicts who were discharged from rehabilitation centres coupled with lack of financial supports, caused the addicts to go back to addictions. Yunos (1995) asserted that employers always took advantage on the former addicts by paying low salaries without taking into consideration their qualifications and experience, causing dissatisfactions amongst the former addicts that eventually caused them to quit their jobs.

Yahya& Mahmood, (2002), found that the treatment and rehabilitation programs being conducted in any country had faced various challenges. The effectiveness of drug rehabilitation programs is one of the failure factor why drug addiction cannot be cured in Malaysia. This is because some researchers found drug rehabilitation programs conducted on addicts are less effective to jolt them to awake (Mokhtar, 1997, Wellish&Prondergast, 1995). Many research found that the traditional treatment and rehabilitation models failed to help in curing the addiction to drug use (Habil, 2001; Mahmud Mazlan, Schottenfeld&Chawarski, 2006; Mohamad & Mustafa, 2001; Mahmood,

MdShuaibChe Din and Ismail Ishak, 1998; McLellan, 2002; Nestler, 2002; O'Brien, 2006 ; Reid, 2007). Mazlan. al (2006) had reported that the ineffectiveness of the rehabilitation program are contributed by these 3 factors; treatment policy which had been confined to a single treatment modality; the regimental rehabilitation programme; despite strong published evidence that addiction to drugs is a medical condition, earlier approach had totally ignored the medical therapeutic approach.

In addition, Mazlan and friends (2006) also stated that in response to the poor results to the rehabilitation program by the government, substitute treatment with methadone was recently introduced as part of treatment programme for heroin addicts. Habil (2001) also said that the effectiveness intervention for heroin addiction is only complete when combined with medical input. Noor Zuraniet, al (2008) mentioned that there are no medication that promises cure for drug addiction. The only way is to find medication which can minimise the harm caused by heroin addiction. This situation is similar to diabetic mellitus, where drugs such as insulin and other hypoglycemic agents are prescribed to minimise the harm caused by the disease.

However, in Malaysia, the use of methadone was limited as it was against the total abstinence philosophy and also was thought to compromise the nation's goal of becoming drug-free society (UNAIDS and UNDCP, 2000). This limitation to the methadone has become one of the factor why the heroin addiction cannot be cured in Malaysia.

Mahmood Nazar Mohamed & Muhamad DzahirKasa (2007) support Mazlan and friends statement that substitution therapies is a way to cure the drug addiction. Substitution therapies have been used in the management of nicotine and opioid dependence. Substitution for opioid dependence which consists of agonist producing and opiate type effect or antagonists, a narcotic blocking agent that prevents the drug of dependence having a similar effect on the user. In the international drug field, there is growing evidence that opiod agonist maintenance treatment is effective and is being widely used (Institute of medicine, 2006). Harden (2002) and Leavitt (2003) stated that the substitution treatments can stabilize a drug user's life by addressing and reducing their physical dependency and diminish various health, social and economic harms. Dole and Tenore (2003) described that the goals of the therapy include preventing the withdrawal syndrome, reducing narcotic craving and blocking the euphoric effect of illicit opioid use.

However, most drug users who are in the programme do not have adequate finances to purchase the substitute drugs (at the time of data collection, 2mg of subutex cost between RM10-12, and an 8mg pill cost between RM30-34), thus there is a possibility that some will resort to cheaper alternatives when they do not have the money for the substitute (for example ketum leaves).

## **Implementation challenges**

According to Blume (2005) theories, methods and techniques that can be used to treat drug addiction has always been a debate among researchers. This is because the recovery of a group of factors is not equal to any other group based on differences in the group setting, time period and also the attitude of the drug addicts group itself. Thus, for the selection of drug addicts, it should be threaded carefully so as not to involve participants who have the syndrome of psychotic problems (Caroll,1998). The detail selection will make the treatment process become easier.

The shortage of professional counsellors in the rehabilitation centers there have been efforts to stifle the rehabilitation of drug addicts effectively and professionally. (Tan Soo Yin et.al., 2007). In addition, the redundant duties in the government sector and the scope of tasks and vague lines of authority between government bodies related to the prevention and rehabilitation of drug addicts causing the recovery process becomes more complex, problematic and inefficient. (Hussain Habil& Mustafa Ali Mohd, 1999).

## **Conclusion**

This study concludes that the failure to cure the addictions among drug addicts in Malaysia is because of the addicts themselves who are lack of strong self-efficacy to avoid temptations, hurdles and challenges in life. They are extremely sensitive individuals, easily emotional and easily stressed by social pressures from the environment. The impact of the weak personality and self-efficacy caused them their good judgments in managing their life, which should be safer and free from drugs. Although they thought that the drug rehabilitation programs they have gone through in two years is effective to help rehabilitate them from the drug effects and received strong support from friends and family to be able to free from drug, these factors would not be able to stop them from continuously

chained by drug problems after they were released. This is because they continued to be tagged as 'no good' individuals or the 'community's trash' by the community after they were released from rehabilitation centres, causing them to feel uneasy to mingle with the community, to be more ostracized, low self esteem, and felt them being left out. The situation would becoming worst and pressured when efforts to get jobs amongst the former addicts met the dead end. This is because most employers are prejudicial and has no confidence in their ability to contribute in the productivity of the nation. With low self-efficacy and the feeling of being ostracized by the community and employers raised conflict and psychological imbalance in the addicts. These confusions are the factors that drove former addicts to the old habits by taking up drugs, after their new life faced the difficulties and challenges.

The success of the government treatment and rehabilitation program is very dependent on the quality of psychosocial intervention provided to the participants. The treatment and rehabilitation programme in the country has been shifted from being totally run by the government to start utilizing the services of NGOs and private medical practitioners. Existing drug counsellors can be utilized to provide counselling and psychosocial support. Group meetings and support groups could be set up to provide additional services for the participants of the programme. Regulations and monitoring should be enhanced to increase the efficacy of the service.

The new policy involving methadone substitution therapy and counselling have been proven to be effective in treating heroin addiction and would need support and cooperation from all parties involve. However, the medicine for drug substitution should be always consistent. Drug users on maintenance therapy must get their regular dosage. Failure to do so will make them resort to other illicit drugs.

It is for us to rethink of a new approaches forward by combining the medical and psychosocial approach in managing the addiction problem in Malaysia. It is the hope for future generations to continue living without succumbing to drug addiction. Otherwise, a situation may arise in which the next generation will die prematurely or lose their potential to maintain what we currently enjoy. This is because addiction to drugs is like a silent virus that, once established, can make our whole generation be enslaved by their addicted brain.

## **References**

- Rusdi AR, Noor Zurani MHR, Muhammad MAZ, Mohamad HH. A fifty-year challenge in managing drug addiction in Malaysia. *Journal of University of Malaya Medical Centre*. 2008;11:3-6.
- Agensi Antidadah Kebangsaan. Maklumat dadah 2009. <http://www.adk.gov.my>. Published 2009. Accessed January 6, 2011.
- National Drug Information System (January 2007). National Anti Narcotics Agency, Ministry of Internal Security and Home Affairs.
- Ismail, R. (1998). HIV/AIDS in Malaysia. *AIDS*. 12 (suppl B): pp S33 S4 1
- Mahmud Mazlan, Schottenfeld, RS and Chawarski, MC (2006). New Challenges and Opportunities in Managing Substance Abusers in Malaysia. *Drug and Alcohol Review*, 25, 473-478.
- Mazlan, M.S., R.S. Chawarski, M.C., New challenges and opportunities in managing substance abuse in Malaysia. *Drug Alcohol Dependence*, 2006. 25: p. 473-478.
- Habil, H., Managing heroin addicts through medical therapy. 2001: University Malaya Press.
- Harden, RN. (2002). Chronic opioid therapy: Another reappraisal. *APS Bulletin*. 12(1)
- Leavitt, S.B. (2003). The methadone dose debate continues. *Addiction Treatment Forum*. 12(1):1,3. <http://www.atforum.com/>.

# THE EFFECTIVENESS OF BRIEF COGNITIVE BEHAVIORAL THERAPY MODULE ON LOCUS CONTROL AMONG DRUG ABUSERS

Huzili Hussin<sup>1</sup>, Nur Salimah Alias<sup>2</sup>, Mohamad Hashim Othman<sup>3</sup>, Abd. Majid Mohd Isa<sup>4</sup>, Kamarudin Hussin<sup>5</sup>, Nor Azmah Karim<sup>6</sup> & Ku Azira Ku Aziz<sup>7</sup>

Universiti Malaysia Perlis<sup>1,2,4,5,6,7</sup>  
Universiti Sains Malaysia<sup>3</sup>

## ABSTRACT

Addiction has robbed an individual self-control and freedom. However, individuals who suffer with addiction always feel they still can control themselves and remain free like everyone else but actually they need to be treated in order for them to regain their potential back. Therefore, the purpose of this study is to explain the effectiveness of Brief Cognitive Behavioural Therapy module on locus of control among drug abusers. The quasi experimental design with one treatment group [CBT (B)] and one control group (KW) and four measurements (pre, post1, post 2, and post 3) were employed in this study. The sample of 108 drug abusers was chosen using purposive sampling procedure. Samples were then distributed randomly into two groups: CBT (B) and control group (KW). Each group consisted of 36 samples. Data were collected with standardized psychometric instruments, including Internal Control Index (Patricia Duttweiler, 1984) and Rosenberg Self-Esteem Scale. Data were analyzed using Two-way ANOVA repeated measurement. Result demonstrated significant differences on main effects between time occasions on locus of control mean score [ $F(2.76, 17.22) = 322.77; p < .05$ ]; and interaction effect between group and time occasions on locus of control mean score [ $F(5.53, 17.22) = 60.28; p < .05$ ]. As a whole, this study shows that CBT (B) intervention is able to increase locus of control mean score among the subjects. Moreover module used in this study had also been tested among drug abuser in Rumah Pengasih (Centre of Rehabilitation in Malaysia) and proving that this module can be used as a guidance and also used as one of the approaches applied in all treatment procedures of drug addiction in Malaysia.

**Keywords:** Drug Addiction, Cognitive Behavioral Therapy, Effectiveness

## 1.0 Introduction

After independence gained for Malaysia in 1957, despite having the Dangerous Drugs Act since 1952 (Abdul Rani, 2007 & Athimulan, 2007) the fight against drug abuse is still slow, even though the number of drug addicts is increasing influenced by the impact of 'hippies' culture around the world and also the impact of the withdrawal of American army in Vietnam that led to drug dealers and suppliers began to shift to search for users among young people in the countries of Southeast Asia. This was due to Malaysia at that time was still new as a nation and facing a problem with communist and communal strife in 1969. After the Malaysia government is committed and stable, then in 1983, Malaysian government has declared drug as a threat to national security after 65% of young people aged 20 to 29 years has been involved with drug abuse. Therefore till this day drug problem still remain and requires diligence and integrated effort to overcome this problem. Study by Kamaruddin, Abd. Majid, Abdull Halim, Huzili, Mohamad Hashim, Norismiza, Nor Azmah and Ku Azira (2008) shown that drug addiction has



involved a 0.22 per cent or nearly three in each one thousand Malay students in the university is positive in urine test. In addition, the drug menace has also led to the spread of infectious disease among the people. Studies done by Mahmud (2007) on 223 heroin addicts who have agreed to receive study treatment in Drug Research Center in Muar found 5.6% of diseased detected Hepatitis B positive, 88.3% were detected Hepatitis C positive, 18.8% is detected positive HIV disease and 14.6% likely suffered from tuberculosis of the lungs. This drug threat also cause big problems to adolescents and children aged between 10 and 18 years old when they do not feel guilty when tried sniffing glue (Mohammad Shahid and Mahmood, 2007). In particular, drugs are a serious threat not only to the addicts themselves but also has undermined the institution of the family and the community.

## 1.1 What Is Cognitive Behavioral Therapy (CBT)?

According to Westbrook, Kennerly and Kirk (2009), CBT is based on two major types of therapy, namely: (a) Behaviour therapy developed by Wolpe in 1950 and 1960; and (b) Cognitive Therapy developed by Beck around 1970. The combination of basic principles in Behaviour Therapy and Cognitive therapy, the CBT is proposed and comprised several elements such as cognitive elements, emotions, behaviour and physiology.

Beside that according to O'Donohoe (2009) the development of CBT can be categorized into three stages of generations; first generation is only focus on the exploration of human fundamental attitudes and habits, second generation is focus on experimental study about the effectiveness of the integration between behavioral therapy and cognitive therapy, lastly the third generation focus more on the rehabilitation methods and a more effective techniques to treat the clients. This third generation is also known as third wave by Hayes (2004). Based on Mahmood (2003), CBT is an counselling approach based on the strategy of recognize, avoid and cope. Training skill based on CBT focus on the strategy on how to cope the addiction by using a ways of build motivation to change, build a ability to solve problem, plan and manage a high risk situation to repeat and build up a skill to avoid drug.

Generally, brief counselling is used from 1949. Most of the counselling sessions that has been done in 1949 to 1979 is average five to six sessions only. Meanwhile there is a study that had shown the effectiveness of counselling sessions that had been done about 12 sessions or 6 sessions is not significantly different. Therefore, a brief counselling session is more optimum to be used (Garfield, 1980). According to Dryden (1995), brief counselling is not only limited to use the CBT approach but there are various approach that can be used such as psychodynamic, behaviour approach, REBT (*Rational Emotive Behavioral Therapy*), Gestalt approach and strategic approach. Even though Brief Cognitive Behavioural Therapy CBT(B) is always being related with reducing the cost (Feltham & Dryden, 2004; Stevens & Craske, 2002), the objective of carrying out the therapy is more profitable to the client because it does not involve long exploration problem process, but more focused on behaviour and cognitive changes so that they will learn the skills to help themselves to solve their problems (Branch & Wilson, 2010; Budman, 1986; Gladding, 2006 Wilding & Milne, 2010).

According to Craig (2004) Brief Therapy is not necessary a short and simple session only, this is because brief therapy has a different method and objektif of rehabilitation. It need a different frame and intervention modul. The approach dan the frame of the brief therapy need to focus on client problem, more structured, put a clear target and implement an active activity which fulfill client needs. Researchs show a successful story of how the intervention of CBT help to cure drug addicts, like a study done by Stephens et.al., (2000); Kadden et.al., (2000) and Kaminer dan Burleson (1999). There are also a study that CBT(B) is successfully help to solve problem like depression (Addis & Jacobson, 1996; Kavanagh, Oliver, Lorenc, Caird, Tucker, Harden, Greaves, Thomas, & Oakley, 2008; Moorey, 1996) self control from drug abuse (Griffin, Hohenstein & Humfleet, 1998); phobia (Rachman & Whittal, 1989); grief problem (Malkinson, 2001); and panic attack (Brown & Barlow, 1995; Tsao, Lewin & Craske, 1998).

## **1.2 Problem in Locus of Control Among Drug Addicts**

According to Miller (2010), locus of control is the sources of individual self control. There are 2 kind of sources that are high internal of locus control and high external of locus control. For those who have a higher internal of locus control they have the capability to decide and manage their own life. Differently with high external locus of control person, they tend to concern with their surrounding when they to make a personal decision.

This statement is parallel with a study by Stephens et.al., (2000) to 291 respondent of marijuana addicts. 87% of the respondents stated the reason of taking marijuana is because they have low self esteem and 79% respondents show low internal locus of controls. As the result, they will rely more on surrounding as well as fail to make a better path for their own life. Study by Fauziah, Bahaman, Mansor dan Mohd Shattar (2009) shows that factor of low confidence contribute about 64% to repeated drug addicts. Thus, an intervention that could helps to improve their self confident need to been implement to help drug addicts (Fauziah et.al., 2009) to regain their self esteem and internal locus of control..

## **2.0 Research Methodology**

Researcher has test the effectiveness of Brief Cognitive Behavioral Therapy using two studies. First study use quasi experimental design with one treatment group [CBT (B)] and one control group (KW) and four measurements (pre, post1, post 2, and post 3) were employed in this study. The sample of 108 drug abusers was chosen using purposive sampling procedure. Samples were then distributed randomly into two groups: CBT (B) and control group (KW). Each group consisted of 36 samples. Data were collected with standardized psychometric instruments, including Internal Control Index (Patricia Duttweiler, 1984) and Rosenberg Self-Esteem Scale. Data were analyzed using Two-way ANOVA repeated measurement.

In the second study, researcher critically reviewed research done by Noor Azniza, Muhammad Syamsul, Nazar (2014), this study used a same module tested for a pilot test among drug addicts in Rumah Pengasih (Centre of Rehabilitation in Malaysia). 10 respondents were involved and 120 minutes are occupied in each session. For this pilot test study, an experimental method is also employed to conduct the test. It involved comparison between two subject design, CBT+PA and PA where CBT+PA is refer to respondents who undergoing CBT program and also the current program provide by Treatment Center (*Rumah Pengasih*) and PA is refer to the subject who only undergoing the current program.

## **3.0 The Intervention Of Brief Cognitive Behavioural Therapy**

This section will present the intervention module of Brief Cognitive Behavioral Therapy in these studies to improve the locus of control of drug addicted.

### **3.1 Interventions Module of Brief Cognitive Behavioural Therapy among Drug Addicts**

A module of Brief Cognitive Behavioural Therapy developed by the researcher was implemented in this study to determine the effectiveness of CBT[B] to help intrapersonal and interpersonal drug addicts by regain back their self esteem and locus of control. CBT[B] module used in this study have six session within 120 minutes and 12 members in one formed group.

### **3.1.1 First Session: Introduction and Personal Goal**

Generally, the first session is introduction and personal goal. Techniques used in this session are the building of therapeutic relationship, bibliotherapy, psychoeducation, socratic dialogue and SMART techniques. The objective of the first session is to motivate and increase the cohesiveness between subject dan the counselor, improve self confident and increase the awareness of personal goals importance.

### **3.1.2 Second Session: CBT Principles and ABC Concepts**

Then the second session is focussing on CBT principle and ABC concept. The objective of this session is to help clients to understand the concept of CBT, it principle, core belief, toxic thought and NATs. This session also help clients to understand the relationship between ABC concept with their old belief as well as helping them to build up a new belief. A paper work like 'Changing Belief Worksheet' is used where clients will put the inputs in it.

### **3.1.3 Third Session: Identify Low Self Esteem and Ways To Improve It**

In the third session, it focussing on how to help clients regain back their self esteem. Therefore, firstly counselor will help clients to understand the meaning of low self esteem dan teach them on how to determine client's self esteem scale. Counselor used techniques like 'Big I, Little I', coping cards and activities that required the clients to give feedback about their experiences as well as the members in the group and form a ways to improve their self esteem using coping cards.

### **3.1.4 Forth Session: Identify Low Locus of Control and Ways To Improve It**

The same objective is employed in the forth sessions, but this session focus on how to help clients regain back their locus of control. Counselor used techniques like 'socratic Dialogue', 'Deserted Island' and activities that used psychoeducation and feedback to give picture to the clients about how locus of control can be improved if they can change their belief, if they themselves have a strong will to change.

### **3.1.5 Fifth Session: Relationship Between Self Esteem, Locus of Control and Drug Addiction and Termination**

When clients have the understanding of self esteem and locus of control, now in the fifth session they are exposed with meaning and understang drug addictions and how to terminate it. In this session, counselor helps the clients to understand the reality of addiction and cost involve all along the addiction with the expectation they could see addiction is something they cannot afford to pay. Then they were exposed and learned with inputs of 'Regulation For Rehabilitation'. Activities implemented required them to write about their understanding about how they can demolish their addiction.

### **3.1.6 Sixth Session: Self Therapy Preparations and Closing**

The last session is focussing on self preparation for the therapy and closing. Generally, this session help clients to be prepare and set themselves to be ready for the rehabilitation. It focus on how only they themselves is the one who will decide whether they can be cured or not. The clients are required to explain the importance of a self contract and promise for the rehabilitation.

### 3.3 Result of the Interventions: How CBT[B] help to increase Locus of Control (LK) of Drug Addicts?

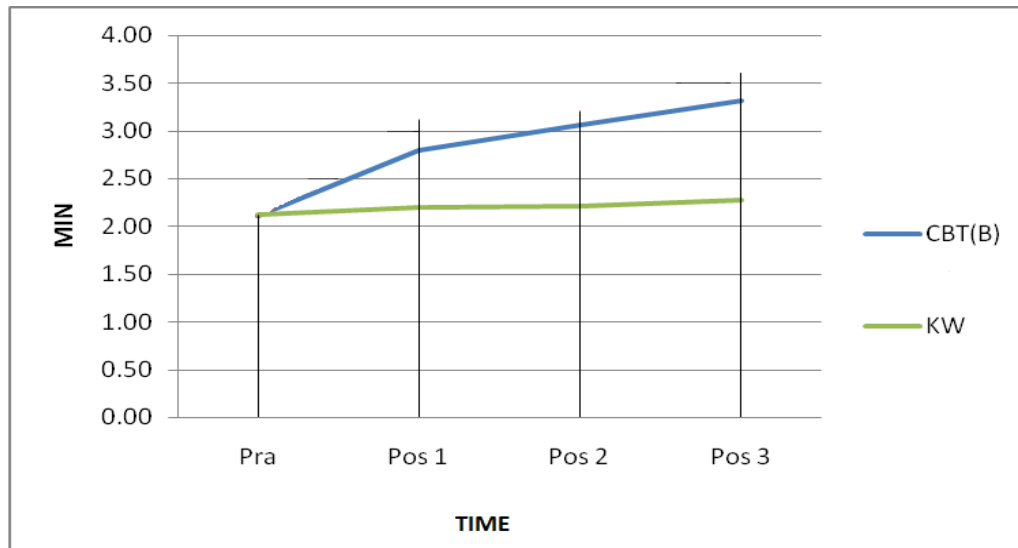
**3.3.1** :: In this first study the effectiveness of the module are measured by the instruments and the results showed based on mean score, mean percentage and the change pattern of LK profile. Therefore, this section will present the results in mean score and standard deviation of locus of control profiling for each groups CBT (B) and KW in each time occasion and the different of mean percentage between time occasions (Pra 1, Post test 1, post test 2 and post test 3). Findings analysis for LK profile for group CBT(B) and KW between time occasions show in table 1;

**Table 4.1:** Analysis findings of LK profile for group CBT(B) and KW between time occasions

	CBT(B)			KW		
	<i>M</i>	<i>SP</i>	% Beza Min	<i>M</i>	<i>SP</i>	% Beza Min
Pra	2.11	.16	-	2.12	.11	-
Post 1	2.80	.28	32.7	2.20	.34	3.8
Post 2	3.07	.25	9.64	2.22	.27	0.91
Post 3	3.32	.24	8.14	2.28	.28	2.7
Pra-Pos 3			57.3			7.54

Result demonstrated LK mean score increased for group CBT(B) between time occasions from Pre-test  $M=2.11$  ( $SP=.16$ ), Post Test 1 ( $M=2.80$ ;  $SP=.28$ ), Post Test 2 ( $M=3.07$ ;  $SP=.25$ ) and Post Test 3 ( $M=3.32$ ;  $SP=.24$ ). While the mean score percentage is 32.7% increase for post test 1 compare to pre test, 9.64% of mean percentage increase for different mean score for post test 2 and post test 1 and 8.4% mean percentage increase for mean score for post test 3 compare to post test 2. Overallly, 57.3% increase in mean score between pre test and post test 3.

While for control group (KW), result show the LK mean score for pre test is  $M=2.12$  ( $SP=.11$ ), ujian Post test 1 ( $M=2.20$ ;  $SP=.34$ ), Post test 2 ( $M=2.22$ ;  $SP=.27$ ) and Post test 3 ( $M=2.28$ ;  $SP=.28$ ). There are in LK mean score for group KW between time occasions. In the aspect of percentage for the mean score the mean score is increase by 3.8% in post test 1 compare to the mean in pre test, increase of 0.91% between mean in post test 2 and post test 1 and increase 2.7% for mean score for post test 3 compared to post test 2. Overallly, the increase is 7.54% between mean score percentage of pre test and post test 3. The description of changes in LK profil for each group between time occasions is showed in figure 1.



**Figure 4.1:** Changes pattern in LK profile for each group CBT (B) and KW between time occasions.

Figure 4.1 also demonstrated at the pre test, mean score between control group (KW) and CBT (B) are find quite similar CBT(B) (M=2.11; SP=.16), dan KW (M=2.12; SP=.11). While post test 1, mean score of CBT(B) (M=2.80; SP=.28) are higher than KW (M=2.20; SP=.34). A same pattern showed in post test 2, CBT(B) (M=3.07; SP=.25) and KW (M=2.22; SP=.27). The different is higher in post test 3, CBT(B) (M=3.32; SP=.24) and KW (M=2.28; SP=.28).

The findings from this research conclude from the different of LK mean score, mean percentage and the change pattern, the result showed CBT(B) are more effective to increase the LK mean score compared to KW between time occasions. In other word, the intervention of CBT (B) are more effective to help drug addicts regain their locus of control as the key for them to be successfully treated.

While the experimetal result presented from the second studies shows clients who undergoing the program showed a tendency to change based on the implemented sessions. The pilot test is also showed clients feel ease and comfortable with this module which are interactive and suitable with duration time (less than 120 minutes). However, to ensure the intervention runs smoothly, the counselor need to explain deeper to the respondents before begin a sessions.

**3.3.2 :** In the second Study: Interventions of Brief Cognitive Behavioural Therapy among Drug Addicts in Rumah Pengasih the same CBT module developed by researcher is used in this pilot test study. The method of qualitative finding ar as follows;

#### **First Session: Introduction and Personal Goal**

In this session, client are exposed with the goal about why they are joining the treatment program (CBT). They have been exposed about CBT approach, how to increase self esteem and locus of control, eliminate addiction and improve self skills. They are given a paper work and homework . Finding showed in this first session most of the clients are not understand why they need to be in the treatment program thus not interested with the session.

#### **Second Session: CBT Principles and ABC Concepts**

In the second session, it focus on the understanding of the meaning and principle of CBT, understand the concept of Core Belief, Toxic Thought dan NATs concept. Clients are also been explained about the relationship between ABC concept with individual's old and new belief. Clients are given five paper work

and one homework. In this session, clients are started to show interest when they start to talk about their issue during the group session.

### **Third Session: Identify Low Self Esteem and Ways To Improve It**

Third session is to identify low self esteem of clients and ways to improve it. Researcher will explain about self esteem and low self esteem. Clients are given five paper work to increase not only their self esteem but also each person in the group. Most of the respondents have low self esteem especially when they talking about when they finish their rehabilitation treatment and comeback to the outside world.

### **Forth Session: Identify Low Locus of Control and Ways To Improve It**

While in the forth session used to identify low locus of control of the client and ways to increase it as well as how importance locus of control to clients. Low and wrong locus of control in clients will make them to have a constant change. In this session, clients are given with four paper work and one homework. Interaction in this session becoming better as they start to show commitment and two ways of communications between the member's in the group.

### **Fifth Session: Relationship Between Self Esteem, Locus of Control and Drug Addiction and Termination**

In the fifth session, the focus of intervention is deeper by relating the self esteem and locus of control they understand in the early session with addiction generally and how to totally overcome drug addiction. Research tell about the effects of drug addiction to themselves, their family, community and country and also the cost they need to pay to undergoing the treatment in rehabilitation centre. In this session, three paper work and one homework are given to accomplish session fifth goals.

### **Sixth Session: Self Therapy Preparations and Closing**

Sixth session is the last session in this intervention. As a last session, researcher recalled back the earlier five session including recheck back all the paperwork and homework done by the clients. Counselor give the understanding of the importance of 'Preparing for setbacks' for a constant changes. At the end of the session, all of the members in the group hugs each other and make a promise to help each other in the rehabiliton process.

## **4.0 Benefits of Brief Cognitive Behavioural Theraphy helps to Improve Locus of Control (LK) of drug addicts.**

The increases of LK mean score for treatment group CBT [B] might be because of the input in CBT module are applying skill of identifying characteristic of low locus of control and how to increase it. Besides that, the improvement of LK might be also because techniques of '*deserted island*' and '*Socratic dialogue*' exposed to the clients. According to Curwen, B., Palmer, S. & Ruddel, P. (2000) '*deserted island*' technique could help to change individual's internal belief for them to believe more to their own self and not depending to others. Furthermore, according to Beck (2011) and Beck, A.T., Rush, A.J., Shaw, B.F. and Emery, G. (1979). '*Socratic dialogue*' techniques could help to answers a general questions asked by the samples along the intervention to more specific questions. In other words, their problem could be analyzed more accurate by the counselor.

The effectiveness of this module could is also because of the therapeutic relationship build up between the clients influenced by the process of systematic group counseling start from early stage, middle stage and final stage. The forming of therapeutic relationship during the interventions are really importance and concerned by Curwen et.al. (2000) and Wills, (2008) so that the problem can be solve correctly. Based on Mior (2009), he said that there are a significance different between treatment group

which emphasize on therapeutic elements compared to control group which did not apply the therapeutic relationship.

Meanwhile, according to Mahmood (1999), a role in rehabilitation counseling can help clients build a new, positive behavior, develop problem-solving skills and potential, strengthen family relationships, increase self-esteem, self-awareness, positive thinking and help them to develop the independent attitudes. Meanwhile, according to Mahmood et.al (1999), a role of counseling in rehabilitation is to helps clients have a significant changes in a psychological aspects such as depression, anxiety, self-esteem and to increase self-esteem, a decreased in levels of anxiety and depression will directly help clients locus of control can be enhanced. The effectiveness of group counseling in this study is consistent with the findings by McKay et al (1997), where he found that the implementation of group counseling is more effective than individual counseling in recovering cocaine addicts. Similarly, the study by Marques and Forgimini (2001) which summarizes both group and individual counseling approach can solve the problem of alcohol and drug addiction.

This might occurs due to the possibility of modifying CBT (B) at an early stage with emphasis on the construction of personal goals as well as teaching the sample to change their ways of thinking through the understanding of the principles of CBT and correlates with the concept of ABC . Applying these elements are in line with the recommendations Corey (2000) that the construction of new behavior should start at the beginning of the session. Moreover, with the exposures about the concepts and principles of CBT at an early stage can challenge their thinking patterns (Trower, P., Jones, J., Dryden, W. & Casey, A. (2011) and change the perception of their thinking more positively (Curwen et al, 2000). The increase in mean scores of LK is quite significant also likely due to the use of the technique of 'changing worksheet belief' and 'SMART' in the intervention has given them an awareness about the importance of building personal goals with a systematic and orderly manner and at the same time can enlighten themselves about behaviors that can help and harm them.

## 5.0 Conclusions

Overall, this study shows that Brief Cognitive Behavioral Therapy Intervention is effective in improving locus of control of drug users compared with the control group that did not receive any treatments. We can conclude that through structured and systematic module and the committment of dedicated, skillfulled and experienced counselor can help to ensure the success of the intervention using CBT approach through group counseling methods for drug rehabilition. It is clear from the results of this study, this module can be used as a reference for the development of experimental research in Malaysia and most important is it can also used as one of the approaches applied in all treatment procedures of drug rehabilitions in Malaysia..

## References

- Abdul Rani Kamaruddin (2007) The misuse of drugs in Malaysia: Past and present. *Jurnal Anti Dadah Malaysia*, Bil.1, Jun 2007, 1-24.
- Addis, E. M., & Jacobson S. N. (1996). Reason for depression and the depression of cognitive behavioral psychoterapies. *Journal of Consulting and Clinical Psychology*, 64 (6), 1417-1424
- Branch, R. & Wilson, R., (2010) *Cognitive Behavioural Therapy for Dummies 2<sup>nd</sup> edition*. England: John Wiley & Sons, Ltd.
- Budman, S.H. (1986). *Forms of Brief Therapy*. New York ; Guilford Press.

- Brown, T.A. & Barlow, D.H. (1995) Long-term outcome in cognitive behavioral treatment of panic disorder: Clinical predictors and alternative strategies for assessment. *Journal of consulting and clinical psychology*, 63, 754-765.
- Beck, A.T., Rush, A.J., Shaw, B.F. and Emery, G. (1979). *Cognitive therapy of depression*. New York: Guilford Press.
- Beck, J.S. (2011). *Cognitive Behavior Therapy: Basics and beyond (2<sup>nd</sup> ed.)*. New York: Guilford Press.
- Craig, R.J. (2004). *Counseling the alcohol and drug dependent client. A practical approach*. USA: Pearson Education.
- Curwen, B., Palmer, S. & Ruddel, P. (2000)
- Corey, G. (2000). *Theory and practice of group counselling (5<sup>th</sup> Ed.)*. CA: Brooks/Cole Publishing Company.
- Dryden, W. (1995). *Brief Rational Emotive Behavior Therapy*. Chichester: Wiley.
- Fauziah Ibrahim, Bahaman Abu Samah, Mansor Abu Talib & Mohd Shattar Sabran (2009). Faktor menyumbang kepada penagihan relaps dalam kalangan penagih dadah PUSPEN di Semenanjung Malaysia. *Jurnal Antidadah Malaysia*. Jld. 5, 235-251.
- Feltham, C., & Dryden, W. (2004). *Dictionary of counseling, (2<sup>nd</sup> ed.)*. London: Whurr Publishers Ltd
- Garfield, S. (1980). *Psychotherapy: An Eclectic Approach*. New York: Wiley
- Gladding, S.T. (2006). *Counseling a comprehensive profession (6<sup>th</sup> ed.)*. New Jersey: Prentice Hall.
- Griffin, P.M., Hohenstein, J.M., Humfleet (1998). Superior efficacy of cognitive behavioral therapy for urban crack cocaine abusers, main and matching effects. *Journal of Consulting and Clinical Psychology*, 66 (5), 832-837.
- Hayes, S.C. (2004). Acceptance and commitment therapy, rational frame theory, and the third wave of behavioral and cognitive therapies. *Behavior Therapy*, 35, 639-65.
- Kamarudin Hussin, Abd. Majid Mohd Isa, Abdull Halim Abdull, Huzili Hussin, Mohamad Hashim Othman, Norismiza Ismail, Nor Azmah Abd. Karim dan Ku Azira Ku Aziz (2008). Kajian pengaruh dadah bagi pelajar lama Institusi Pengajian Tinggi Awam. *Jurnal Antidadah Malaysia* Jld. 3 & 4, 153-173.
- Kadden, R., Christiansen, K., Roffman, R., Kabella, E., & Duresky, D. (2000). Brief treatments for marijuana dependence in adults: APA *Pre-Convention Workshop. Presented at the 108<sup>th</sup> Annual Convention of the American Psychological Association*. Washington, DC.
- Kaminer, Y., & Burleson, J.A. (1999) Psychotherapies for adolescent substance abusers: 15 month follow-up. *American Journal on Addictions*, 8(2), 114-119
- Mahmud Mazlan (2007) Penyakit berjangkit di kalangan penagih heroin yang menerima rawatan pesakit luar di Muar. *Jurnal Antidadah Malaysia*. Bil. 1, 73-80.
- Mahmood Nazar Mohamed (2003), Merawat Penagih Dadah Melalui Kaunseling dan Pendekatan Berperspektif Islam. *Prosiding Seminar Kebangsaan Kaunseling Berperspektif Islam*. Universiti Utara Malaysia.



- Mahmood Nazar Mohamed (1999). Mumulihkan Penagih Tegar : Implikasi kepada Modaliti Masa Kini. *Prosiding Kerja Sosial*, Universiti Utara Malaysia.
- Mahmood Nazar Mohamaed, Md Shuaib Che Din, Lasimon Matokrem, Muhamad Dzahir kasa dan Rusli Ahmad (1999). *Penagihan dadah dan residivisme: Aspek-aspek psikososial dan persekitaran*. Sintok: Universiti Utara Malaysia..
- Malkinson, R. (2001). Cognitive-Behavioral Therapy of Grief: A Review and Application. *Research on Social Work Practice*, vol. 11 no. 6, 671-698 doi: 10.1177/10497315010110060.
- Marques, A.C. & Formigoni, M.L.(2001) comparison of individual and group cognitive behavioral therapy for alcohol and/or drug dependent patients. *Addiction*, 96, 835-846. doi: 10.1080/09652140020050951.
- Mckay, J. R., Alterman, A. L., Cacciola, J.S., Rutherford, M. J., O'Brien, C. P. & Koppenhaver, J, (1997) Group counselling versus individualized relapse prevention aftercare following intensive outpatient treatment for cocaine dependence: initial results, *Journal of Consulting and Clinical Psychology*, 65, 778-788.
- Miller, G. (2010). *Learning the language of addiction counseling (3<sup>rd</sup> ed.)* Canada: John Wiley & Sons, Inc.
- Mior Hamdan Ghazali (2009). Kesan penerapan unsur-unsur terapeutik dalam kaunseling kelompok terhadap kebimbangan sosial dan lokus kawalan. (*Tesis Doktor Falsafah, 2009*). Universiti Sains Malaysia (tidak diterbitkan).
- Mohammad Shahid Ismail dan Mahmood Nazar Mohamed (2007). Remaja menghidu gam: Pengaruh keluarga dan rakan sebaya. *Jurnal Antidadah Malaysia*. Bil. 1, 131-150
- Moorey, S. (1996) Cognitive Behaviour Therapy for whom?, *Advances in Psychiatric Treatment*. Vol. 2, 17-23
- Nor Azniza Ishak, Muhammad Syamsul Mat Zain, Mahmood Nazar Mohamed, Muhammad Dzahir Kasa, Zulkama azura Zulkarnain & Siti Sarah (2014). Intervensi Terapi Kognitif Tingkah laku Terhadap Kesiediaan Berubah dan Estim Kendiri Penghuni Rumah Pengasih: kajian Rintis (Pengujian Modul CBT). *Prosiding Pendidikan dan Kaunseling*. Medan: UNIMED
- O'Donohue, W.T. (2009). A brief history of Cognitive Behavior Therapy: Are there troubles ahead? in *General principles and empirically supported techniques of Cognitive Behavior Therapy*. New Jersey: John Wiley & Sons Inc.
- Rachman, S. & Whittal, M. (1989). Fast, slow and sudden reductions in fear. *Behaviour Research and Therapy*, 27, 613-620.
- Stevens, H., H. & Craske, M., G. (2002). Brief Cognitive-Behavioral Therapy : definition and Scientific Foundations dalam *Handbook of Brief Cognitive Behavior Therapy*. New York: John Wiley & Sons.
- Stephens, R.S., Roffman, R.A., & Curtin, L. (2000). Extended versus brief treatments for marijuana. *Journal of Consulting & Clinical Psychology*, 68, 898-908.
- Trower, P., Jones, J., Dryden, W. & Casey, A. (2011). *Cognitive behavioral counseling in action*. (2<sup>nd</sup> ed.) London: SAGE Publications Ltd
- Tsao, J.C.I., Lewin, M.R. & Craske, M.G. (1998). The effects of cognitive behavior therapy for panic disorder and comorbid conditions. *Journal of Anxiety Disorder*, 12, 357-351.

Wills, F. (2008). *Skills in cognitive behavior counseling and psychotherapy*. London: SAGE Publications Ltd.

Wilding, C. & Milne, A. (2010) *Teach Yourself Cognitive Behavioural Therapy*. USA: McGraw-Hill.

Westbrook, D., Kennerly, H. & Kirk, J. (2009). *An introduction to Cognitive Behaviour Therapy; skills and applications*. London : SAGE Publications Ltd.

## Drug Abuse Among Higher Learning Institutions Students In Malaysia: Meta-Analysis of Exploratory Studies

Mohamad Hashim Othman<sup>1</sup>, Abd. Majid Mohd Isa<sup>2</sup>, Kamarudin  
Hussin<sup>2</sup>, Huzili Hussin<sup>2</sup>, Abdull Halim Abdul<sup>2</sup>, , Nor Azmah Abd. Karim<sup>2</sup> &  
Ku Azira Ku Aziz<sup>2</sup>

1 Universiti Sains Malaysia

2 Universiti Malaysia Perlis

### Abstract

*This paper highlighted the meta-analysis findings on six researches commissioned to a group of researchers appointed by the Ministry of higher Education to explore the pattern of drug abuse amongst students in higher learning institutions (HLIs) in Malaysia, in-line with the intention that HLIs in Malaysia are free from drug abuse by 2015. A total of 16,252 HLIs students from public and private universities, polytechnics, and community colleges were involved in this study. Their urine were tested and they were asked to respond on standardised questionnaire. Based on the analysis, on average, only 0.15% HLIs students tested positive. Thus, based on ASOD protocol, the HLIs students are drug-free (still below 1%). However, the students can be considered as 'high risk' group because they have little knowledge about the danger of taking drugs especially new synthetics drugs, they also reported to have friends involved in drug abuse and they have never seen drugs before. The alarming number of university students that are being recruited as a drug mules are being attributed to this pattern. With the findings, the HLIs can formulate strategies to combat drug abuse so that they can generate first class human capitals needed for the nation building.*

**Keywords:** drug abuse, higher learning institution, urine test, screening

### Introduction

Drugs are nothing new in human life because its use has been traced back centuries ago, although the exact date is not known. To this day, illicit drugs have become a major threat to the most of country in the world especially in developing countries. Approximately 5% of the world population (200 million people) between 15 and 64 years of age uses one illicit drug at least once a year (UNODCCP, 2008). According to the World Drug Report since 2008, (UNODC 2013), the number of illicit drug users has shown 18% increase. The most common age range of illicit drug abusers in the world is 18 to 25 years. A number of research studies of illicit drug use among adolescents, especially students have been carried out in different countries and different levels of educations. Murad, (1979) found that among drug abusers, the use of amphetamines ranked first (39.6%), followed by cannabis (30.6%), tranquilizers (12.6%), cocaine (10.1%), barbiturates (7.3%) and lysergic acid diethylamide (1.8%). Meanwhile Decarvalho (1986) concluded that 23.8% of them are university students. Among the illicit drug users, cannabis (41.2%) was the most frequently used substance. A survey in 2001 showed that 24% of Iranian university students had used narcotics at some time in their lives (Merchant, 1976). An exploratory study of Shiraz University students' attitudes towards illicit drug use (cigarettes, alcohol, opium, heroin and cannabis) showed that about 52% had smoked cigarettes, 25% had tried alcohol, 21% opium and 12% cannabis, and one student had used heroin (Ghanizadeh, 2001). Illicit drug

abuse is now also involving higher learning institution students in Malaysia. This problem has now become the focus of the ministry of higher education to ensure that students in higher learning institution (HLIs) free from drug abuse.

Thus, several studies have been conducted to determine the number of students involved in illicit drug abuse among which is the study of new public university junior students (Kamarudin, et al., 2005), public university senior students (Kamarudin, et al., 2007), polytechnic students (Kamaruddin, et al., 2000), students at community colleges students (Kamarudin, et al., 2000), private university students, (Kamaruddin, et al., 2000) and public university foreign students, (Kamarudin, et al., 2000).

### **Objective**

The present study aimed to investigate the knowledge on the effect of illicit drug amongst students in higher learning institutions (HLIs) in Malaysia, and to identify HLIs students involved in drug abuse through urine screening test.

### **Materials And Methods**

A cross-sectional study was conducted on 16,252 higher learning institution students (Table 1) randomly selected from the Malaysian Higher Learning Institution students.

Table 1:

Higher Learning Institution	n	%
Public Universities	7109	44
Polytechnic & Community Colleges	6339	39
Private Universities	1990	12
Public University Foreign Students	814	5
<b>Total</b>	<b>16252</b>	<b>100</b>

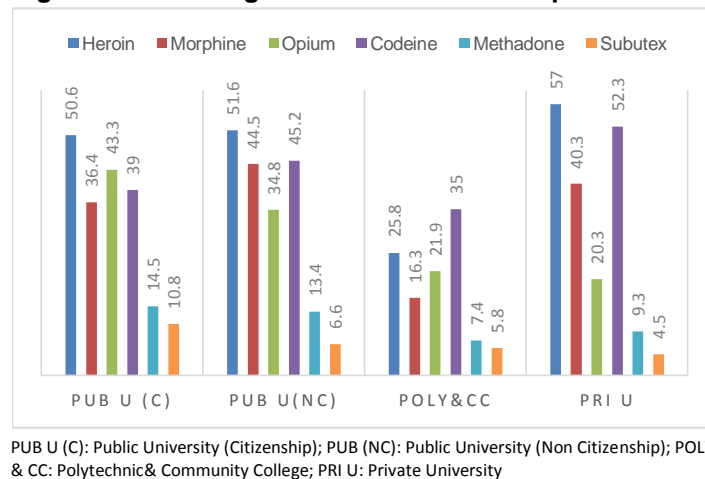
Data were collected using a questionnaire developed by the researchers and urine screening test. Urine was tested using DOA test (Drugs Of Abuse in urine) which can detect four types of drugs such as Amphetamine (AMP); cocaine, tetrahydrocannabinol (THC); Cannabis / Marijuana, Opiate (OPI); Morphine, Heroin and Methamphetamine (MET); Ecstasy. The urine drug test was taken as the reference standard in this study because it was already instituted by the university authority. Descriptive statistical methods (including statistical indices, formulating frequency distribution tables and drawing related diagrams) were used in order to meet the research objectives. This study focuses only on the four types of drugs, that are opiates, stimulants, cannabis and depressant.

## Result

### Knowledge about the effects of opiates

There are six types of illicit drugs under the category of opiates that are heroin, morphine, opium, codeine, methadone and Subutex. The study found that students in polytechnics and community colleges lack of knowledge about the impact of these drugs on students compared to other higher institutions. Effects of opiates such as heroin, morphine and opium were widely known by higher institution students compared with synthetic opiates (methadone, Codeine and Subutex) by which many university students are still not aware of the consequences (Figure 1).

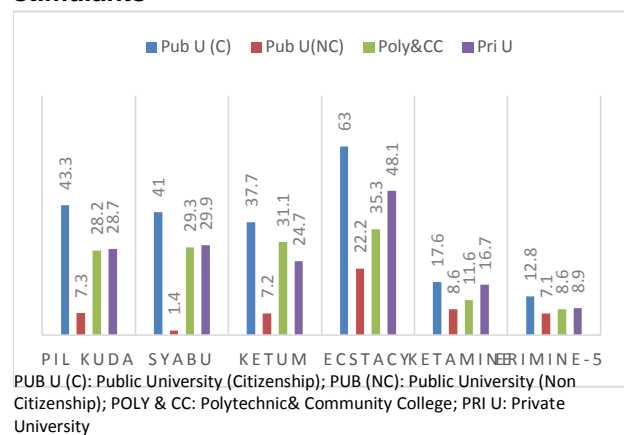
**Figure 1: Knowledge about the effects of opiates**



### Knowledge about the effects of stimulants

There are six types of illicit drugs under the category of stimulants that are 'pilkuda', 'syabu', 'ketum', ecstasy, ketamine and Erimine-5. Many higher institution students, especially students of public universities (63%) know the effects of ecstasy abuse. In general, the result (Figure 2) show that foreign students have little knowledge about the effects of drug under stimulants category (7% - 8%) except for ecstasy (22%) compared to student from other higher institutions.

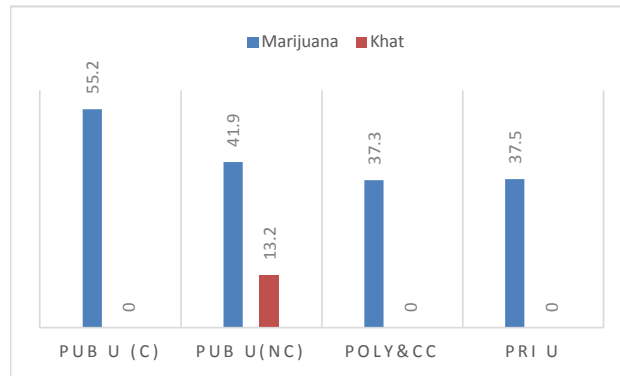
**Figure 2: Knowledge about the effects of stimulants**



### Knowledge about the effects of Cannabis

There are two (2) types of illicit drugs in the category surveyed, namely marijuana and Khat. Based on the information in Figure 3, many higher institution students know about the effects of marijuana abuse, and only a handful of foreign students who know about the effects of khat leaf.

**Figure 3: Knowledge about the effects of Cannabis**

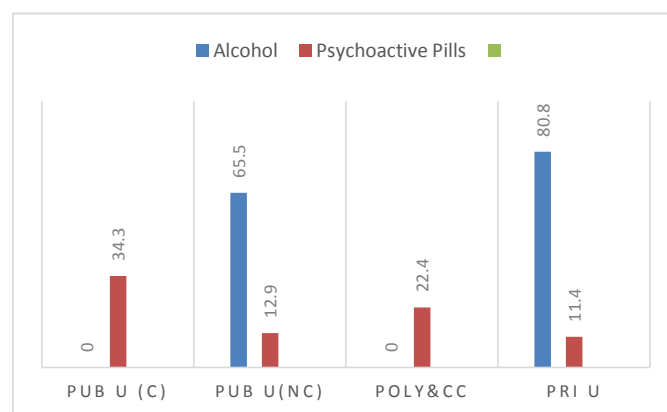


PUB U (C): Public University (Citizenship); PUB (NC): Public University (Non Citizenship); POLY & CC: Polytechnic & Community College; PRI U: Private University

### Knowledge about the effects of Depressants

Two (2) types of illicit drugs in depressant category that are alcohol and psychoactive pills used for this study. Alcohol was only asked when conducting research for overseas students. For psychoactive pills, one-third (33%) of public university students know the effects of abuse. Most foreign students (67%) in a public university also know the effects of the abuse of psychoactive pills (Figure 4).

**Figure 4 Knowledge about the effects of Depressants**



PUB U (C): Public University (Citizenship); PUB (NC): Public University (Non Citizenship); POLY & CC: Polytechnic & Community College; PRI U: Private University

### Respondents Positive Urine Test

The results of the urine tests analysis have found 86 out of 16,252 (0.52%) students have been detected positive in urine tests. According to the protocol ASEAN Senior Official on Drug Matter (ASOD), this number is still below 1% and HLIs in Malaysia is drug-free, but there is some concern about the prevalence of which it should be taken seriously.

**Table 3: Respondents Positive Urine Test**

IPTA	n	%	prevalence
Public University (N)	18	21	0.25
Polytechnic & Community College	50	60	0.79
Private University	14	17	0.70
Public University Foreign Student	2	2	0.25
<b>Jumlah</b>	<b>84</b>	<b>100</b>	<b>0.52</b>

### Types of Drugs Abuse

Table 4 shows that 84 respondents found positive in urine test screening. MET and THC is the most abused drug (each n = 27 and n = 25), OPI (n=11), AMP (n=10) respectively, and THC & AMP (n = 7).

**Table 4: Types of Drug Abuse by the HLIs Students**

Types of Drug	PUB (C)	PUB (NC)	POLY & CC	PRI U	n (%)
OPI	1	1	5	4	11 (13.0%)
MET	8	0	14	5	27 (32.0%)
AMP	4	0	4	2	10 (12.0%)
THC	2	1	19	3	25 (30.0%)
MET & AMP	0	0	2	0	2 (2.5%)
THC & OPI	2	0	0	0	2 (2.5%)
AMP & THC	1	0	6	0	7 (8.0%)
<b>Total</b>	<b>18</b>	<b>2</b>	<b>50</b>	<b>14</b>	<b>84 (100%)</b>

## **Summary**

In conclusion, the present study shows that HLIs in Malaysia is free from drugs. Studies on drug abuse among HLIs students will provide insight on individual, social as well as environmental risk factors and help Ministry of Higher Education to have a better understanding of this complex phenomenon. Efforts are needed to inculcate the awareness of HLIs students about drug abuse. Knowledge and awareness about drugs helps the students to shun away from abusing drug. Preventive programs should focus on various goals like improvement of knowledge about harmful effects of drug.

## **Reference**

- Decarvalho. F. V. (1986). Drug use among university students in the state of Sao Paulo, Brazil, *Bulletin on Narcotics*, 38, Nos 1 & 2, 37 – 40.
- Ghanizadeh A. (2001). University student's attitude towards drugs: An exploratory study, *Eastern Mediterranean Health Journal*, 7(3), 452-460.
- Kamarudin Hussin, Abd. Majid Mohd Isa, Abdull Halim Abdull, Huzili Hussin, Mohamad Hashim Othman, Norismiza Ismail, Nor Azmah Abd. Karim dan Ku Azira Ku Aziz (2010). *Penyalahgunaan Dadah Pelajar Institusi Pengajian Tinggi Awam*. Kangar: Penerbit Universiti Malaysia Perlis.
- Merchant N.M. et al. (1976). Factor related to drug abuse among Iranian University students. *Pahlavi Medical Journal*, 7(4), 516-528.
- Murad. J. E (1979) " Drug abuse among students in the state of Minas Gerias, Brazil " *Bulletin on Narcotics ( United Nations Publication )* 31, 1, 49 – 58
- UNODC, *World Drug Report 2013*, United Nations Office on Drugs and Crime, Vienna, Austria, 2013
- United Nations Office for Drug Control and Crime Prevention (UNODCCP). *World drug report 2008* [Online]. 2008. [cited 2008 May 16]; Available from: URL: <http://www.unodc.org/unodc/data-and-analysis/WDR-2008.html>.



## The Effectiveness of At-Risk Criteria and Psychometric Measure in Identifying Drug Abuse Students in Malaysia Higher Learning Institutions

Abdul Majid Mohd Isa<sup>1</sup>, Kamarudin Hussin<sup>2</sup>, Mohamad Hashim Othman<sup>3</sup>  
Huzili Husin<sup>4</sup>, Nor Azmah Abdul Karim<sup>5</sup>, Ku Azira Ku Aziz<sup>6</sup>

University Malaysia Perlis<sup>1,2,4,5,6</sup>  
Universiti Sains Malaysia<sup>3</sup>

### Abstract

To date, urine test is widely used to identify students abusing drugs. Since urine test require certain protocols and costly to administer, a more rapid and cost effective screening test has to be developed as an alternative. A psychometric measure namely Substance Abuse Subtle Screening Inventory or SASSI by Miller (1994) has been widely used in USA to identify at-risk adolescent that may involved in abusing drugs, substance and alcohol. In this particular study, Malay version of SASSI was administered to selected 2021 students using proposed at-riks criteria enrolled at 13 Polytechnics. They are categorised by SASSI into four categories namely Low Possibilities (LP), Low Possibilitiede Futher Action (LPFA), Substance Abuse Dependence (SAD) and Substance Dependence Disorder (SDD). All students in SAD (n=51) and SDD (n=27) were asked to take urine test and for those in LPFA, 319 respondents were randomly selected to take urine test. Based on this procedure, at-risk criteria able to identify 10 times more students than random selection. Later, after SASSI was administered, the perentage increase to 12.3% from 2.4%. With the proposed model of identification, almost all student can be secreened and the administration of urine test will be confined to about 5% of student population.

**Keyword:** *SASSI, Effectiveness, Psychometric Measure, Drug, Abuse, At-Risk Student, Malaysia Higher Learning Institution*

### INTRODUCTION

Since 2005, Ministry of Higher Education Malaysia (now Ministry of Education) has implemented decisions made by the National Council of Drug Abuse to conduct urine test and undertake study on drug abuse amongst higher learning institution students. The Ministry has formed a taskforce so that by 2015, the higher learning institutions in Malaysia will be drug-free. The taskforce is chaired by Dato Prof Dr Kamaruddin Husin, Vice Chancellor of Universiti Malaysia Perlis and Prof Abd Majid Mohd Isa, formerly Deputy Vice Chancellor of Universiti Malaysia Terengganu. Initially the taskforce members are from Universiti Malaysia Perlis and Universiti Malaysia Terengganu but has been expanded to include members from Universiti Sains Malaysia, Cyberjaya University College of Medical Sciences and Islamic International University Malaysia. To date the Ministry has allocated nearly RM3 millions to conduct research and consultancy works relating to drug abuse.

Based on six (6) research projects conducted in the first phase of the study, all Malaysia Institutions of Higher Learning, except College Community, are reported to have below than 1% incidence of positive urine for drugs, Thus, using standard proposed by *ASEAN Senior Official on Drug Matters* (ASOD), they are drug free. However, based on the knowledge, exposure and experience, students enrolled in Malaysia Institutions of Higher Learning have lower self-control to drug especially new synthetic drugs. They can be easily lured into drugs abuse related activities. This is evident when a number of drug mules recruited in Malaysia are higher learning students.

Currently, only urine test is used to as a screening for drug abuse. Urine test as a screening for drug abuse has it shortcomings. It only detected after drugs are being consumed and only sensitive to the established drugs. The cost of administration is costly and time consuming. For students that are well versed with law and regulation, the question of legality compounded the administration as only authorised and trained personnel are authorised to conduct urine test. Moreover, drug abuse is linked to substance and alcohol abuse, in which urine test is not able to detect. As a guardian for precious human capital for the nation, the Ministry has to address drug, substance and alcohol abuse simultaneously. Therefore is a need to have a more effective screening tool so that the students involved in drug, substance and alcohol abuse can be identified for rehabilitation.

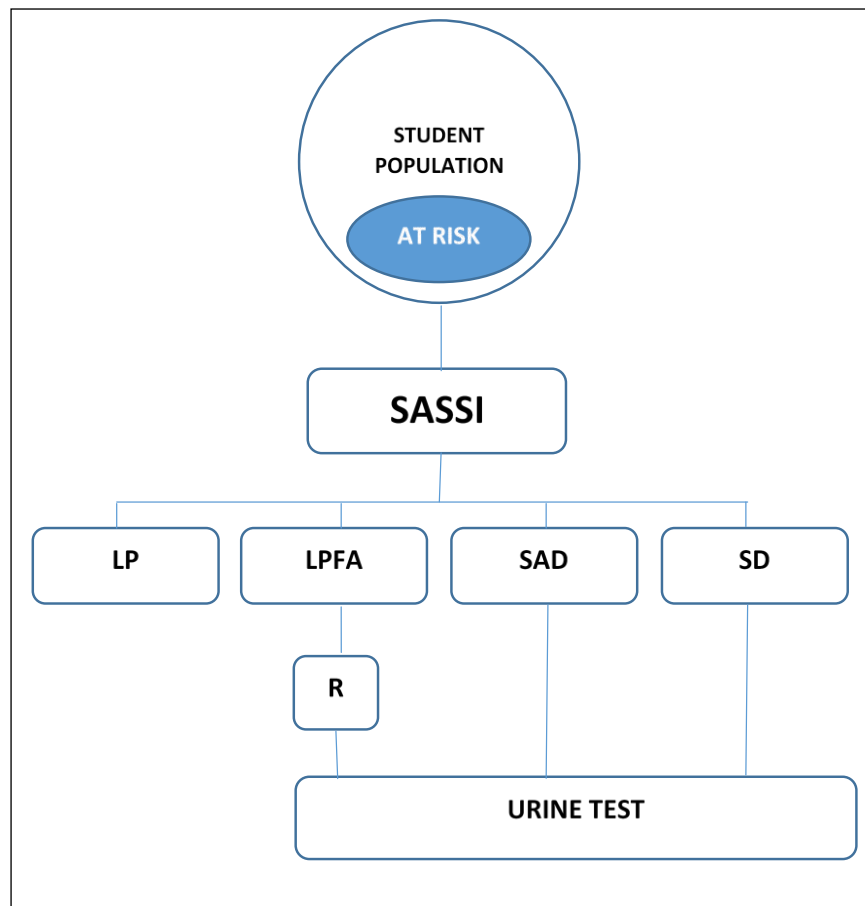
The crucial action after achieving drug-free status is to maintain the status. A more convenient tool has to be developed so drug, substance and alcohol abuse students can be identified as early as possible. A workshop attended by the officials from Ministry, Police, Anti Drug Enforcement Agency and Universities proposed the taskforce to conduct study on at-risk student using a more effective screening procedure. The workshop suggested that at-risk student to include low academic achievement, university rule and regulation offender, medically not fit and enrolled in stressful programs.

As for screening measure, the taskforce is evaluating the SASSI-A2 (Substance Abuse Subtle Screening Inventory), a 72 items questionnaire developed by Miller (1985) as a rapid appraisal. The items of SASSI-A2 was translated into Malay and administered by Khaidir (2009). It has four subscales namely LP (Low Probability), LPFA (Low Probability Further Action), SAD (Substance Abuse Disorder) and SDD (Substance Dependence Disorder). Based on the information provided by the manual and report by Khaidir (2008), SASSI-A2 has sufficient validity and reliability to be a potential screening tools for drug, substance and alcohol abuse.

## **EVALUATION MODEL**

With the new directive given by the Ministry, the taskforce propose the identification model for drug, substance and alcohol abuse as follow:

### Identification Model



### OBJECTIVES

The study is conducted to:

- a. Gauge the effectiveness of at-risk criteria to be used to identify student potentially abusing drug, substance and alcohol.
- b. Determine the effectiveness of ASSSI-A2 as screening measure after the student being screened as at-risk.

### RESEARCH METHODOLOGY

The identification model proposed to the Ministry is used as a framework for this research. A sample size is calculated using the equation  $n = \frac{z^2 pq}{E^2}$ . Based Confident level (z) of 95%, with the assumption of not more than 3% population involved in drug, substance and alcohol abuse (p) and maximum error (E) is 4%, the number of responden needed is only 70 per polutechnic. However to decrease error, the taskforce decided to have 210 respondents for each college.

Using 4 (four) criteria of at-risk student, the college administration identified at least 210 students and sent the list to taskforce secretariat. Each student was given a password for them to access SASSI-A2 online within two weeks. Upon completion, they are automatically categorised as LP (Low Probability), LPFA (Low Probability Further Action), SAD (Substance Abuse Disorder) and SDD (Substance Dependence Disorder). Few days later, the taskforce members administered urine test to 35 selected students that consisted of all SAD and SDD, and the rest are randomly selected among LPFA.

## RESEARCH INSTRUMENT

There are (2) instruments used in this study to generate data namely '*Substance Abuse Subtle Screening Inventory*' (SASSI-A2) and urin test.

### **SASSI (*Substance Abuse Subtle Screening Inventory*)**

It was developed by Miller in 1985 as a screening inventory. Since the average age of respondents in this particular study is 19 years old, a 72 items SASSI-A2 version developed for adolescent was used. After administration, the respondents are categorised into LP (Low Probability), LPFA (Low Probability Further Action), SAD (Substance Abuse Disorder) and SDD (Substance Dependence Disorder).

SASSI-A2 has convincing validity to identify user/abuser of drug, substance and alcohol from diverse backgrounds and gender. Miller and Lazowski, (2001) reported that the accuracy to detecting user/abuse is 90.2% among African American, almost 100% among Asian American; Caucasian 94.5%; Hispanic American 93.8% and Native American 98.2%. As for gender, the accuracy for man is 93.8% and woman 95.4%.

SASSI-A2 initially translated into Bahasa Melayu by Khaidzir et al. (2009) by using '*back to back translation*' technique. Taskforce has reviewed the translation and recommended various ammenments. The final translated version is given to three English lecturers to be translated back into English. Based on the feedback, 20.8% of the items are correctly translated, 70.9% need grammatical correction and 8.3% or six item required total correction.

As for the Malay version SASSI-A2, a pilot study was conducted using 152 university students. The reliability, using split-half is 0.72. However, using Spear-Browm correction formula, the relaiability is 0.84. The respondents took 12-25 minutes to complete the SASSI-A4 on-line.

According to the manual, SASSI-A2 will categorised students into four categories. Usually about 5% are in SAD and SDD. The rest are in either LP or LPFA. To ensure that the Malay version has similar capibility, the findings in table 1 indicates that the Malay version has similar capability as the original version.

Table 1: Categorization of Respondents

Category	Khaidzir (2009)	Pilot
LP	17.2%	19.5%
LPFA	80.0%	74.3%
SAD	0.8%	4.7%
SDD	2.0%	1.5%
SASSI-A2	100%	100%

### Urine Test

The common instrument used to detect whether the respondent is consuming drugs is urine test. In this study, **Fast Screen Drug Combo Test** telah was used. It is able to detect the presence of 5 (five) categories of drug simultaneously. The category is **Amphetamine (AMP)**; syabu, **Tetrahydrocannabinol (THC)**; /Marijuana, **Opiate (OPI)**; Morphine, Heroin; **Methamphetamine (MET)**; Ecstasy dan **Ketamine**. Cut off values for Fast Screen Drug Combo Test detecting the drugs are as in Table 2.

Table 2: Specification **Fast Screen Drug Combo Test**

Drugs	Cut-off (ng/ml)
Amphetamine (AMP)	1000
Barbiturates (BAR)	300
Benzodiazepines (BZO)	300
Cocaine (COC)	300
Erimin (ER5)	300
Ketamine (KET)	1000
Marijuana (THC)	50
MDMA	1000
Methamphetamine (MET)	1000
Morphine (MOP)	300

**Fast Screen Drug Combo Test** is in line with **DOA tests (Drugs Of Abuse in urine)** and comply with cut off points set by **NIDA (National Institutes Drugs Agency)**.

## FINDINGS

### Respondents

A total of 2021 students identified by 13 Community College administrators using criteria set by the taskforce participated in this study (Table 3). The average respondent for each college is 155 the error of estimation can be further reduced. To about 1%. The data derived from the whole respondents can be used to make generalization.

**Jadual 3: The Distribution of Respondent According Polytechnic**

Polytechnic	Lelaki	Perempuan	Jumlah
Ungku Omar	48	18	66
Sultan Ahmad Shan	106	87	193
Sultan Abdul Halim	100	96	196
Kota Bahru	105	47	152
Kuching	85	54	139
Port Dickson	127	46	173
Kota Kinabalu	63	56	119
Sultan Salahuddin Abdul Aziz Shah	87	105	192
Ibrahim Sultan	83	65	148
Seberang Perai	105	41	146
Sultan Mizan Zainal Abidin	84	94	178
Merlimau	58	59	117
Tuanku Syed Sirajuddin	97	105	202
<b>TOTAL</b>	<b>1148</b>	<b>873</b>	<b>2021</b>

## The Effectiveness of At-Risks Criteria and SASSI-A2

The findings of this research can be summarised as in Table 3.

**Table 3 : The Effectiveness of At-Risks Criteria and SASSI**

At-Risk Criteria	Phase I: At-Risk Student (N=2021)		Category	Phase II: SASSI (n=397)	
	n	+ve Urine n (%)		n	+ve Urine n (%)
	2021	49(2.4)	<b>LP</b>	0	0 (0%)
			<b>LPFA</b>	319	32 (10.0%)
			<b>SAD</b>	51	10 (19.6%)
			<b>SDD</b>	27	7 (25.9%)
Effectiveness	49/2021*100=2.4%			397	397/49*100= 12.3%
Overall	12.3/2.4=5.125				

### a. Effectiveness of At-Risk Criteria

In 2009, the taskforce found that 0.23% from randomly selected 3964 polytechnic students having positive urine test result (Kamaruddin et.al., 2009). The selection of respondents using at-risk criteria resulted 49 of 2021 are positive in urine test thus the incident of drug abuse is 2.4%. With at-risks criteria, the effectiveness of identifying those likely abusing drugs are increased to more than 10 times.

### b. Effectiveness of SASSI.

As indicated earlier, SASSI categorised respondents into four category namely LP (Low Probability); LPFA (Low Probability Further Action); SAD (Substance Abuse Disorder); and SDD (Substance Dependence Disorder). In order to determine whether SASSI-A2 has the potential to serve as screening measure to identify drug abuser/user, it has to have convincing psychometric evidences.

### Ribiability and Validity SASSI-A2

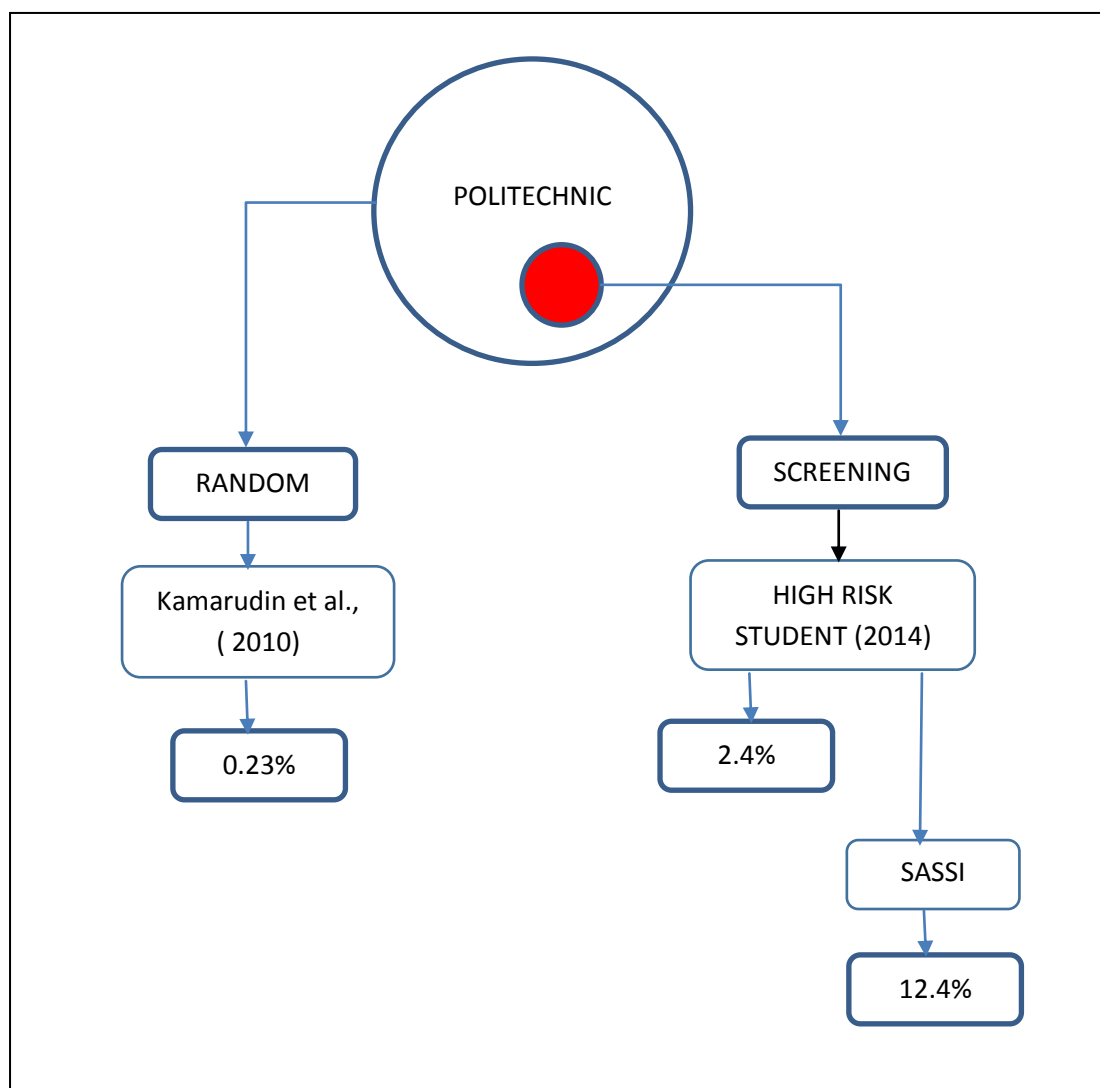
The pertinent psychometric evidence of any psychological inventory or instrument is reliability and validity. As for reliability, the most commonly used measure is internal consistency (Abd Majid, 1994). There is different standard used for individual dan group test. Nunnally and Bernftein (1994) proposed that minimum of 0.9 is required for individual test and 0.7 is sufficient for group

test. The reliability of Malay version SASSI-A2 used in this study is .88. As for validity, a translated version has the ability to group the respondents according to the constructs of the original version.

#### A. SASSI-A2 As Screening Inventory

Based on the score generated by SASSI-A2 administered on-line, a total of 397 students undergo urine test. They consisted of all SAD and SDD and the rest are randomly selected from LPFA groups. According to the information derived from Table 3, the 49 positively tested urine respondent came from LPFA, SAD and SDD are 10%, 19.6% and 25.9% respectively. With only 397 respondent tested, the incidence of drug abuse is 12.3%.

To recapitulate, the diagram below summarised the findings regarding the comparison of effectiveness between random and screening procedures in identifying drug abuse.





## CONCLUSION AND RECOMMENDATION

Based on the findings of this study, urine test directed by the Malaysia Council on Drug Abuse to identify students involved in abusing drugs can be enhanced effectively by using model proposed by the taskforce. Furthermore, with screening procedure, the authority at polytechnic level can be more focus in combatting drug abuse as the target group can be identified. However, more study has to be conducted especially to fine tune SASSI so that it can served as effective screening inventory and urine test is as confirmatoty.

## REFERENCE

- Abd Majid Mohd Isa (1994) Keberkesanan Inventori Raven SPM dalam Mengenal Pasti Kanak-Kanak Pintar Cerdas (*The effectiveness of Raven's SPM in identifying intellectually gifted Malay children*), **Pertanika Journal of Social Sciences and Humanities, Vol. 1, no 2**, 63-68.
- Abdul Rani Kamarudin, 2002. Legal Aspect on the Control and Prevention of Dangerous Drugs Misuse: Comparative Study of Malaysian and English Laws. **Doctoral Thesis**: Exeter University.
- Kamarudin Hussin, Abd. Majid Mohd Isa, Abdull Halim Abdull, Huzili Hussin, Mohamad Amran Hassan (2007). Kajian pengaruh dadah dalam kalangan pelajar baru Institusi Pengajian Tinggi Awam. **Jurnal Antidadah Malaysia**, 2, 1-12.
- Kamarudin Hussin, Abd. Majid Mohd Isa, Abdull Halim Abdull, Huzili Hussin, Mohamad Hashim Othman, Norismiza Ismail, Nor Azmah Abd. Karim dan Ku Azira Ku Aziz (2008). Kajian pengaruh dadah bagi pelajar lama Institusi Pengajian Tinggi Awam. **Jurnal Antidadah Malaysia**, 3 & 4, 153-173.
- Kamarudin Hussin, Abd. Majid Mohd Isa, Abdull Halim Abdull, Huzili Hussin, Mohamad Hashim Othman, Norismiza Ismail, Nor Azmah Abd. Karim dan Ku Azira Ku Aziz (2010). **Penyalahgunaan Dadah Pelajar Institusi Pengajian Tinggi Awam**. Kangar: Penerbit Universiti Malaysia Perlis.
- Kamarudin Hussin, Abd. Majid Mohd Isa, Abdull Halim Abdull, Huzili Hussin, Mohamad Hashim Othman, Norismiza Ismail, Nor Azmah Abd. Karim dan Ku Azira Ku Aziz (2010). Kajian pengaruh dadah bagi pelajar Politeknik Kementerian Pengajian Tinggi. Dalam Kamarudin Hussin, Abd. Majid Mohd Isa, Abdull Halim Abdull, Huzili Hussin, Mohamad Hashim Othman, Norismiza Ismail, Nor Azmah Abd. Karim dan Ku Azira Ku Aziz. **Penyalahgunaan Dadah Pelajar Institusi Pengajian Tinggi Awam**. Kangar: Penerbit Universiti Malaysia Perlis.
- Kamarudin Hussin, Abd. Majid Mohd Isa, Abdull Halim Abdull, Huzili Hussin, Mohamad Hashim Othman, Norismiza Ismail, Nor Azmah Abd. Karim dan Ku Azira Ku Aziz (2010). Kajian pengaruh dadah bagi pelajar Kolej Komuniti Kementerian Pengajian Tinggi. Dalam Kamarudin Hussin, Abd. Majid Mohd Isa, Abdull Halim Abdull, Huzili Hussin, Mohamad Hashim Othman, Norismiza Ismail, Nor Azmah Abd. Karim dan Ku Azira Ku Aziz . **Penyalahgunaan Dadah Pelajar Institusi Pengajian Tinggi Awam**. Kangar: Penerbit Universiti Malaysia Perlis.
- Kamarudin Hussin, Abd. Majid Mohd Isa, Abdull Halim Abdull, Huzili Hussin, Mohamad Hashim Othman, Norismiza Ismail, Nor Azmah Abd. Karim dan Ku Azira Ku Aziz (2010). Kajian pengaruh dadah bagi pelajar Institusi Pengajian Tinggi Swasta Kementerian Pengajian Tinggi.

- Kamarudin Hussin, Abd. Majid Mohd Isa, Abdull Halim Abdull, Huzili Hussin, Mohamad Hashim Othman, Norismiza Ismail, Nor Azmah Abd. Karim dan Ku Azira Ku Aziz . **Penyalahgunaan Dadah Pelajar Institusi Pengajian Tinggi Awam**. Kangar: Penerbit Universiti Malaysia Perlis.
- Kamarudin Hussin, Abd. Majid Mohd Isa, Abdull Halim Abdull, Huzili Hussin, Mohamad Hashim Othman, Norismiza Ismail, Nor Azmah Abd. Karim dan Ku Azira Ku Aziz (2010). Kajian pengaruh dadah bagi pelajar luar negara Institusi Pengajian Tinggi Awam. Dalam Kamarudin Hussin, Abd. Majid Mohd Isa, Abdull Halim Abdul, Huzili Hussin, Mohamad Hashim Othman, Norismiza Ismail, Nor Azmah Abd. Karim dan Ku Azira Ku Aziz . **Penyalahgunaan Dadah Pelajar Institusi Pengajian Tinggi Awam**. Kangar: Penerbit Universiti Malaysia Perlis.
- Khaidzir Hj. Ismail, Mohd Fauzi Mohd Jani, Abdul Hamid Jaafar, Fariza Md Sham, Zainab Ismail, Doris Padmini a/p Selvaratnam, Noriah Mohd Ishak & Khairil Anuar, (2009). SASSI -2: Pengesan Penanda Awal Penyalahgunaan Dadah Dan Bahan Dalam Kalangan Pelajar IPTA (Kajian Kes Di Universiti Kebangsaan Malaysia), **Jurnal Antidadah Malaysia**, 6, 2, Disember, 1-15.
- Miller, F. G. (1985). The **SASSI Manual. Substance Use Measure**. Springville IN. The SASSI Institute.
- Miller, F. G. (1999). The **SASSI Manual. Substance Use Measure**, (2<sup>nd</sup> Edition). Springville IN. The SASSI Institute.
- Miller, F. G. & Lazowski, I. E. (1999). **The Adult SASSI-3 Manual**. Springville IN. The SASSI Institute.
- Miller, F. G. & Lazowski, I. E. (2001). **The Adolescent SASSI-A2 Manual. Identifying Substance use disorder**. Springville IN. The SASSI Institute.
- Nunnally, J.C. & Bernstein, I.H. (1994). **Psychometric Theory (3rd Edition)**. McGraw- Hill Series in Psychology, McGraw-Hill, Inc., New York: NY, 264-265.
- Veselska, Z., Geckova, A.M., Orosova, O., Gajdosova, B., Van Dijk, J.P. & Reijneveld, S.A. (2009). Self esteem and resilience. The connection with risky behavior among adolescent. **Addictive Behavior**, 34, 287-291.

## PRIMER ANALYSIS ON DETECTING *Salmonella typhi* BACTERIA DNA USING PRC TECHNIQUE

*Supiana Dian Nurtjahyani*<sup>1)</sup>, *Retno Handajani*<sup>2)</sup>

1) Faculty of Teaching and Education Science/ Department of Biology Science Ronggolawe University Tuban, and 2) Faculty of Medical and Tropical Disease Center, Airlangga University

Contact person: [diantbn@yahoo.co.id](mailto:diantbn@yahoo.co.id)

### Abstract

*Salmonella typhi* bacteria as the cause of typhoid fever are still a problem, especially in tropical countries. Detection of a disease-causing agent of typhoid fever should be done quickly and accurately. PCR can be used as an alternative method in the bacteria *Salmonella typhi*, but the PCR technique has a main obstacle in the selection of primers used in the PCR process. The purpose of this study is to analyze the appropriate primer in the detection of *Salmonella typhi* bacteria DNA by PCR. The method conducted in this research was laboratory experiment. The results in this study with the primer homology 100% positive PCR results in the detection of *Salmonella typhi* bacteria DNA by PCR. The Primer conclusions can precisely detect the DNA of the bacteria *Salmonella typhi*.

Keywords: *Salmonella typhi* bacteria, DNA, primer, PCR

### INTRODUCTION

Polymerase Chain Reaction (PCR) is a technique of synthesis and amplification of DNA in vitro. This technique was first developed by Karry Mullis in 1985. The PCR technique can be used to amplify DNA segments in the amount of millions of times in just few hours (Handoyo 2001). Conventionally, in general serological identification of bacteria, this method requires a long time. In health management agent identification of a disease quickly and accurately is necessary in order to obtain a diagnosis and appropriate treatment. So then, the cause of typhoid fever agent detection method must be developed more efficiently, quickly and accurately with molecular diagnostics approach (Sarjito 2011). PCR is a molecular diagnostics that can be used as an alternative for the detection of *Salmonella typhi* solution because PCR can assist to detect bacteria quickly and accurately, but in the PCR process there is also a constraint, especially when the primer determination would start working PCR. The purpose of this study is to analyze the appropriate primer for detection of

*Salmonella typhi* DNA using PCR technique.

## **METHOD**

This research is an experimental laboratory. The sample in this study is the blood of typhoid fever patients were collected 30 samples from Medika Hospital, Muhammadiyah and R.Kusma Tuban district. The experiment was conducted in a biology laboratory of Ronggolawe University, Tuban and Institute of Tropical Disease (ITD) Airlangga University Surabaya on September to November 2012. The research was conducted with the primer analysis of the various references before applied in the PCR process and made useable if the homology was 100% then this primer was chosen to be applied in the process of PCR for detection of *Salmonella typhi* bacteria DNA. Primer checking with the Genetic Mac version 10 carried out as follows:

### **Primer Homology**

Primer homology was performed with the Genetic Mac version 10. The selected primer was on the first primer and the second primer correspond to the regions of the genome of *Salmonella typhi*, used in PCR 1. The primer nucleotide sequence 1 (sense) is: 5'-GCTGCGCGCGAACGGCGAAG-3' and primer 2 (antisense): 5' TCCCGGCAGAGTTCCCATT-3' (Ferretti, et al., 2001).

### ***Salmonella typhi* bacteria DNA amplification using PCR Technique**

Amplification of extracted DNA were performed by PCR with primers that have been selected according to regions of the genome. For DNA amplification reaction *Salmonella typhi* was used: buffer solution Tth 10 X. Enzim *Tth DNA polymerase*, *dNTPs* solution. On the results of the DNA amplification of *Salmonella typhi* electrophoresis using 2% agarose in 0.5 X TBE buffer solution containing ethidium bromide. *Salmonella typhi* DNA from the samples, negative control (use distilled water), positive control and markers ( $\Phi$  x 174 / Hae III digest) that has dispersion can be viewed under ultraviolet light. For documentation of the results, carried out taking pictures with a camera brand Mamiya, using Polaroid Fuji Film 667.

## RESULT AND DISCUSSION

### Result

The primer that was homologized with the Genetic Mac version 10 the results are 100% as follows:

GENETYX : Nucleotide Sequence Homology Data ]

#### 1st Nucleotide Sequence

File Name : *Sal.Enterica.gnu*

Sequence Size : 1918

#### 2nd Nucleotide Sequence

File Name : FORWARD

Sequence Size : 20

Unit Size to Compare = 6

Pick up Location No. = 1

[100.000% / 20 bp] INT/OPT.Score : < 80/ 80 >

481' GATGCTGCGC GCGAACGGCG AAGCGTACTG GAAAGGGAAA  
GCCAGCTTTA CGGTTTCCTTT

\*\*\*\*\* \*\*\*\*\* \*\*\*

1" GCTGCGC GCGAACGGCG AAG

#### 1st Nucleotide Sequence

File Name : *Sal.Enterica.gnu*

Sequence Size : 1918

#### 2nd Nucleotide Sequence

File Name : REVERSE.COMPL

Sequence Size : 19

Unit Size to Compare = 6

Pick up Location No. = 1

[100.000% / 19 bp] INT/OPT.Score : < 76/ 76 >

841' TTGACCATTT CAATGGGAAC TCTGCCGGGA TTCCCGCTGC  
CGGTATTTGT  
TATTTTATCG

\*\*\*\*\*

1" AATGGGAAC TCTGCCGGA

The result of primer homology was then applied in the process of PC R for detection of *Salmonella typhi* bacteria DNA, PCR results in Figure 1

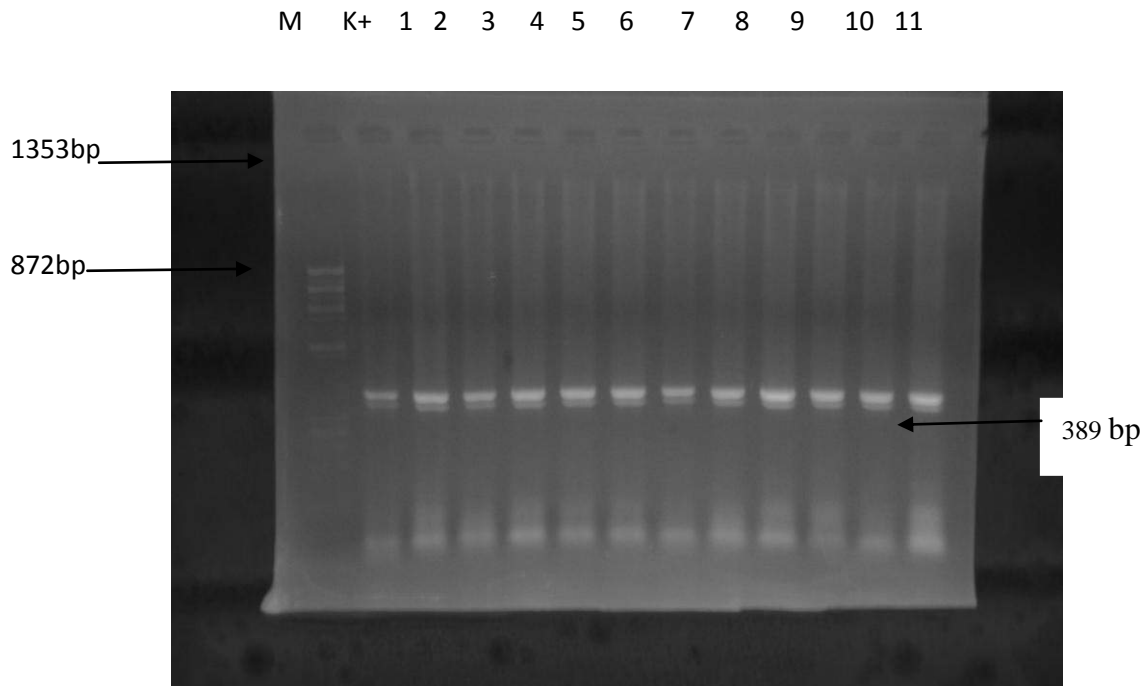


Figure .1 Examples of *Salmonella typhi* DNA PCR with primers of 100% homology with the length of 389 bp

Specification:

M = marker (Ø x 174 / Hae III digest)

K+ = control positive

1 -11 = sample

### Discussion

Results PCR using primers 100% homology showed positive PCR results (Figure 1). From the research seemed to be the primer homology was very important to generate a positive PCR result because the primer is one of determinants in the PCR process. PCR technique with appropriate primers can provide greater positive results in the detection of bacteria, for example, the detection of *M. tuberculosis* result reached 80%

(Rosilawati & Biomed 2007). PCR technique is sensitive and specific for the diagnosis of typhoid fever, with a variety of PCR primer can be developed other techniques such as multiplex PCR, nested PCR that can deliver positive results and more specific (Haque et al. 2005).

The primer used was also important for PCR using RPAD method as the key of RAPD method that the primer used to identify a large number of DNA polymorphisms in random sequences, primers are not specific to a particular gene or genome quickly and efficiently. Type of this polymorphism with particular sequences and DNA binding makes RAPD suitable for the study of diversity complements of various DNA specimen (Anggereini, nd, 2008). The results of the study can detect *Salmonella typhi* bacteria with DNA PCR technique by applying the primer outcome was homologized.

## CONCLUSION

Based on the results of the research and discussion, it can be summarized in the detection of

*Salmonella typhi* bacteria DNA required appropriate primer and 100% homology to obtain a positive PCR result.

## ACKNOWLEDGMENT

Acknowledgements delivered on Medika Hospital, Muhammadiyah, R.Kusma Tuban district that has helped in the collection of samples and the entire biology laboratory staff of Ronggolawe University Tuban and ITD Airlangga University Surabaya.

## REFERENCES

- Anggereini, E. (n.d.,2008). Evita Anggereini, *Random Amplified Polymorphic DNA (RAPD)*, Suatu Metode Analisis DNA Dalam Menjelaskan Berbagai Fenomena Biologi.
- Ferretti, R., Mannazzu, I., Cocolin, I., Comi, G. and Clementi, F. 2001. Twelve-hour based method for detection of *Salmonella* spp. In food. *Appl. Environ. Microbiol.* 67, 977–978.
- Handoyo, D. dan A.R., 2001. Prinsip umum dan pelaksanaan Polymerase Chain Reaction ( PCR ) [ General Principles and Implementation of Polymerase]. , 9(1), pp.17–29.
- Haque, A. et al., 2005. Identification of drug resistance genes in clinical isolates of *Salmonella typhi* for development of diagnostic multiplex PCR. , 21(4), pp.3–8.

- Rosilawati, M.L. & Biomed, M., 2007. Deteksi *Mycobacterium tuberculosis* dan resistensinya terhadap rifampisin dengan metode nested polymerase chain reaction ( PCR ) dan sequencing. , 26(1), pp.1–10.
- Sarjito, 2011. Penggunaan Repetitive Sequence- Sequence - Based Polychain Reaction ( REP - PCR ) Untuk Pengelompokan Bakteri Bakteri *Vibrio* yang Berasosiasi dengan Ikan Kerapu Sakit dari Perairan Karimunjawa. , 16(2), pp.103–110.



# The Qur'an-Based Physics Education at the level of Higher Education; Opportunities and Challenges

A.Halim<sup>1</sup> and Melvina<sup>2</sup>

<sup>1,2</sup>Staff of Department of Physics Education, Teacher Training and Education Faculty  
Syiah Kuala University, Aceh-Indonesia, 23111.

## Abstract

The Qur'an-based physics education means every topic in physics associated with the original source, i.e the Qur'an. Such activities have been carried out since the subjects of the Qur'an-Based Physics enter into the syllabus of Physics Education Department in 2010. The reason for this course was added to the syllabus, including; (i) Experience as a lecturer, seeing that the teaching of physics course is delivered separately with the concepts of Quran. Conversely in the Qur'an there are 800 verses Qauliah that associated with Science (Physics). (ii) During these emerging issues among students silting Aqeedah university, especially in Physical Education Studies Program there is one student who was involved with the case of silting aqidah. (iii) To restore the students' understanding of science (physics) is the origin of the Quran, and the As-Sunnah. The purpose of this course is to connect the student's understanding of physics concepts with the verses of the Qur'an. In practice there are several opportunities and challenges, among his chances; (i) Implementation of this course has the support of the study program managers and teaching staff, (ii) adequate reading materials available in the form of a text book or also material from cyberspace, (iii) Students have a response and high enthusiasm for implementation this course. While the challenge; (i) Lack of teacher knowledge, especially knowledge of the Arabic language and knowledge to interpretation of the Qur'an verses. (ii) Lack of experience of students in tracing the verses of the Qur'an were associated with Science (Physics). (iii) There is no standard reference how teaching techniques this course in order to more efficiently and effectively. Based on the results of qualitative studies and literature review is expected in the future can be developed more raw syllabus with reference to some of the courses that have been experienced by subjects based on the Qur'an.

**Key words:** *challenges and opportunities, the concept of physics, qauliah verses, the Qur'an and Sunnah*

## 1. Introduction

For centuries, since the glory days of Newton until the 21st century now, learning systems of science (physics) separated with the original sources (Qur'an). It seems, science (physics) apart from the verses of the Qur'an. This is in accordance with the nature of science (physics), the truth is acceptable if supported by empirical data, otherwise the verses of the Qur'an is the absolute truth and should not require empirical data. This is the main cause, why in the learning of science (physics) separately with the verses of the Qur'an. This phenomenon is known as "positivistic understanding of secularism". Positivistic secular paradigm that has been introduced into the Islamic world through the understanding of Western Imperialism has left a strong and deep scars. The paradigm has left a serious problem on the status of scientists to the general sciences and religious sciences, scientific sources, objects of scientific, scientific classification, scientific methodology and integration measures general sciences and religious sciences. As a result, awareness of the importance of the spiritual aspect can not change the theory and practice of secular learning (Abdussalam.A, 2011; Fata.A.K, 2012; Syafii.A., 2009; Purwanto.A., 2009; Tamuri&Rahimi, 2011; Toharuddin,dkk, 2011).

When examined in terms of the aspect of faith, understanding of secularism is very dangerous and it would be devastating to the young generation who will study science. Since elementary school (SD) students are introduced to the science based on empirical evidence and never mentioned the name of God or angels in the discussion, as well as junior high, high school, S1, S2, and S3. All science, whether natural science or social science, which originated from Western Imperialism (Europe) not aim to introduce God as the sole creator of all phenomena and laws of nature, but it leads to the death of God (Purwanto, 2009). Learners, has spent the time since elementary school to S3 approximately 23 years to learn science, where the discussion is not to introduce God as the Creator of the Universe. The real goal of the science studying is to improve the faith and piety by introducing Allah as the Creator to the students through the process of education, this is the goal of national

education in the Opening Act 1945. In in Article 31, paragraph 3 states, "The government shall manage and organize a national education system, which can increase the faith and piety and good values in the context of the intellectual life of the nation, which is regulated by law" (UUD45). How faith and piety can be improved while in the process of implementation of education has never been associated with the greatness of Allah as the Creator of all natural phenomena. This is one form of anomalies that occur in the world of education, particularly in science learning. On one side is expected of the students can be faithful and devoted to Allah, on the other hand in the learning process of science is never mentioned the name of God as Creator of all phenomena occurring Single(Matodang.et.al, 2013; Suwarno.et.al, 1998; Toharudin.et.al, 2011; Tamuri.et.al, 2011; Purwanto, 2009).

As a first step to cover the shortfall in higher education (S1 and S2), the Faculty of Education, UNSYIAH, particularly the Department of Physical Education has incorporated two compulsory subjects in the curriculum, namely Physics in the Quran (S1) and Science-Based Al-Quran (S2). Expected in the future, both subjects become a pilot project for other courses in other departments that exist in Shia Kuala University. Through this article, the researchers invited readers and seminar participants for discussing the results of this study related to the challenges and opportunities for the implementation of both the course lectures.

## 2. Methodology of Research

The method used in this research is quantitative method with and the collection of data using survey techniques. The selected sample is 40 students with the requirement that they have followed the course of Physics in the Quran at the Department of Physical Education, so purposive sampling technique was used to select the sample. Questionnaire with 13 items and uses a Likert scale (SS = Strongly Agree, S = Agree, TS = Disagree, and TT = Do not Know ), as a data collection instrument, given to the respondent. Answer students in the form of quantitative data were collected and analyzed using descriptive statistics.

## 3. Result and Discussion

Based on the results of data analysis using descriptive statistics, obtained a summary in the form of a graph as shown in Figure 1.1 below.

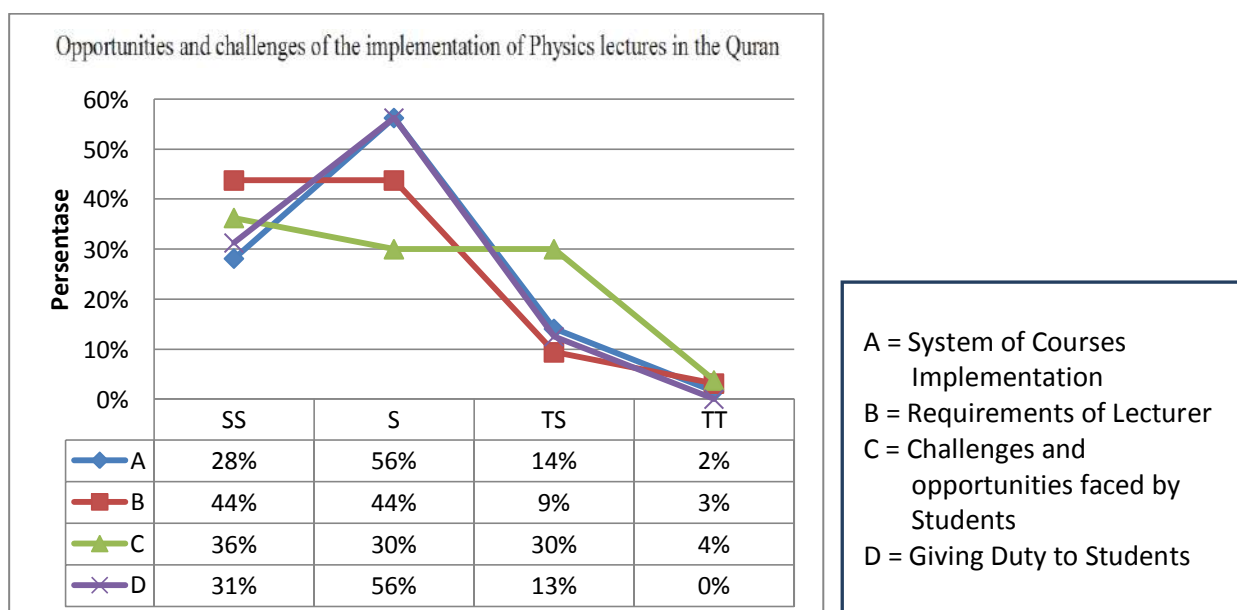


Figure 1.1 Opportunities and Challenges Physics courses in the Quran Student version.

### 3.1. System of Courses Implementation

Based on the results in Figure 1.1 it can be seen that the system implementation of lectures that have been and will be implemented, approximately 84% of them said they agree. Where the courses of Physics in the Quran has been designated as compulsory subjects (100%), the implementation of lectures conducted by the team not per person (56%), half of the hour-long meeting (8 times) taught theory and the other half were given the task to the students (88%), and the entire contents of the course covers the entire content of science subjects (Physics, Biology, Chemistry, and Geography) (94%). When studied in detail the results of student responses to system implementation the courses of Physics in the Quran there are several challenges, including (i) the need to set up a standardized syllabus and lesson plans as compulsory subjects in the department of physics education, (ii) required a team of teachers who understand the physics and Arabic language in depth, and (iii) is also required team science courses (Biology, Chemistry, Physics and Geography). Besides, the subjects of Physics in the Quran also have the opportunity to become a permanent course at the Department of Physical Education, because about (100%) of students said they agree.

### **3.2. Requirements of Lecturer**

Students choose to agree (88 %), lecturer who teaches the courses of Physics in the Quran is the team and one of the team members to master the science of physics, while the other master the Arabic language or interpretation. Getting Lecturer matching with such requirements so difficult. Because teachers who served in the Department of physics education has a background of general knowledge. One of alternative solution is to find a lecturer at State Islamic University (UIN) in the Faculty of Science and Islam.

### **3.3. Challenges and opportunities faced by Students**

Student response to the challenges that exist in the subjects of Physics in the Quran, an average of about 66% agreed and they have experienced such challenges. Among the challenges or difficulties faced by students in following this course is difficult to get a physics topics related to the verses of the Quran (31%), difficulty getting the interpretation of Quran verses in the context of the physical sciences (50%), students are challenged to studying and reviewing the Quran in the context of physics (100%), and students had trouble getting the physics text book where contents associated with verses of the Quran (50%). Instead, students have the opportunity to broaden the study of the Quran (100%). Based on student responses to these components, as a teacher, felt challenged to prepare a physics text book that is associated with the verses of the Quran. Therefore, through this course will be attempted to write a Physics book based the verses of the Quran. In addition, to overcome the shortage of textbooks, lecturers have provided some science text book based Al-Quran, included; The verses of the Universe (Purwanto, 2009), Reason verses universe (Purwanto, 2012), Islamic Astronomy and Science Development (Ilnya, 2003), uncover the Earth Science in the Quran (Sudarmojo, 2009), and Religion and Modern Science (Ahmad, 2008).

### **3.4. Giving Duty to Students**

Student response to administration tasks in the implementation of this course lectures showed good responses (87%), the student agrees to enhancing the knowledge through the provision of duty in the form of a paper (100%), and searching for material on the Internet (75%). Based on the student 's response is quite high in these components provide opportunities for teachers to train students to be more skilled and better understand the meanings of the verses of the Quran. On the other hand, the teaching of this course is also challenged to be making of preparations lectures, including designing a way of giving tasks that more meaningful and quality.

One of the interesting findings of the questionnaire is item no. 8), where 50% of students said they agree and 50% of students say Disagree 50%). Where 50% of students had no difficulty in getting the interpretation of the verses of the Quran in the context of the science of physics, while the remaining 50% of students said it was difficult to get the interpretation of the verses of the Koran in the context of the science of physics. The same is also obtained in the item no.11), where 50% of students had difficulty getting the physics text book discussion associated with the verses of the Koran, while 50% of students say it is easy to get the physics text book discussion associated with ayat- verses of the Koran. Based on both the response can be understood that, prior assumptions Students will have difficulty in getting the topic or material physics associated with the verses of the Quran was not right.

Based on these responses also indicate that teachers are challenged to prepare teaching materials or physics textbooks that discussion is associated with the verses of the Quran.

Table 1.1 . Student response to the implementation of the subjects Physics in the Quran

No	Items	Responses*)	
		A	NA
<b>A System of Courses Implementation</b>			
1	This subject became a compulsory subject in the Department of Physical Education	16	0
2	Implementation of this course taught by a team, not by a teacher	9	7
3	Half of the time the course (8 times face to face) taught concepts and theories, while the other half were given the task to the students for the stabilization of the material .	14	2
4	Contents of lecture material covers all the topics of science (chemistry, biology, geography) that is associated with the verses of the Quran, is not limited to physics	15	1
		<b>54</b>	<b>10</b>
		<b>84%</b>	<b>16%</b>
<b>B Requirements of Lecturer</b>			
5	Lecturers who teach this course should master the Arabic language and also master the physics well	16	0
6	One of the professors who teach this course to master the Arabic language well and another to master physics well.	12	4
		<b>28</b>	<b>4</b>
		<b>88%</b>	<b>13%</b>
<b>C Challenges and opportunities faced by Students</b>			
7	Students having difficulty getting the physics topics related to the verses of the Quran .	5	11
8	Students have difficulty getting the interpretation of the Quran in the context of physics	8	8
9	Through this course students have increased knowledge about the contents of the Quran	16	0
10	Through this course students are challenged to learn and review the contents of the Qur'an in the context of physics	16	0
11	Students have difficulty getting textbook physics, where the discussion is associated with the contents of the Qur'an	8	8
		<b>53</b>	<b>27</b>
		<b>66%</b>	<b>34%</b>
<b>D Giving Duty to Students</b>			
12	To increase knowledge, students taking this course are required to obtain materials on the Internet.	12	4
13	As the main task, students taking this course are required to write a paper on physics topics and discussions associated with the verses of the Quran .	16	0
		<b>28</b>	<b>4</b>
		<b>88%</b>	<b>13%</b>

#### 4. Conclusion

There are some important notes related to the opportunities and challenges of the implementation of the subjects Physics in the Quran at the Department of Physical Education. Student response to the status of the subject as compulsory subjects has opened opportunities and support to put the same course at the Department of others, for example Biology in the Qur'an, Chemistry in the Quran, etc. A level students are very high for system administration tasks in this course, provide an opportunity for teachers to design a form tasks that is more meaningful and quality. Based on 50-50 student response to the difficulties of getting the physics text book discussion associated with the verses of the Quran is a challenge for teachers to prepare teaching materials or textbook discussion physics associated with the verses of the Quran. Another challenge that should be considered are (i) Lack of teacher knowledge, especially knowledge of the Arabic language and science of interpretation of the verses of the Quran. (ii) Lack of experience of students to look for verses of the Qur'an were

associated with Science (Physics). (iii) There is no standard reference how teaching techniques this course in order to more efficiently and effectively.

## 5. Gratituton.

To all those who have been involved with this research, either in the form of thoughts or ideas or material, we say thank you, especially chairman of the Department of Physical Education. Our thanks also goes to teaching team of courses Physics in the Quran and students of Department of Physics Education which has given the good participation in this study.

## 6. References

- Abdussalam.A., (2011). ParadigmaTauhid:  
KajianParadigmaAlternatifdalamPengembanganIlmudanPembelajaran, *JurnalPendidikan Agama Islam-Ta'lim*Vol.9, No.2, 113-126.
- Agustian.A.G., (2008). ESQ, Jakarta: Arga Publishing
- Ahmad.B., (2008). Agama danSains Modern, Kuala Lumpur: DewanBahasadanPustaka.
- Fata.A.K., (2012). MembangunSainsBerbasislman, *Prosiding Conference AICIS*.UIN Semarang.
- Ferguson.K., (1994). Stephen Hawking: Quest for a Theory of the Universe (terjemahan), Jakarta: PustakaUtamaGrafiti.
- Ilyas.M., (2003). Astronomi Islam danPerkembanganSains, Kuala Lumpur: itnm
- Lebor.A., (2009). A Heart Turned East; Among the Muslim of Europe and Amarica, Bandung: Mizan
- Matondang.A.H.,danErdian.S., (2013). Al-Qur'an danSains.*JurnalPolingua*, Vol.2, No.1, 14-24.
- Pasya.A.F., (2004). Rahiq Al-Ilmiwa Al-Iman (terjemahan), Solo: TigaSrangkai.
- Patel.E., (2009). My Islam. My Faith (terjemahan), Bandung: Hikmah
- Purwanto.A., (2009). Ayat-AyatSemesta, Surabaya: Mizan
- Purwanto.A., (2012). NalarAyat-AyatSemesta, Bandung: Mizan
- Raghib.Z., (2013). Al-I'jaz al-ilmi fi al-Sunnah al-Nabawiyah (terjemahan), Jakarta: Zaman
- Saleh.A., (2009). KepentinganUsulFiqhdalamSainsdanTeknologi, PusatPenyelidikanFiqhSainsdanTeknologi, UTM: Program Dialog CFirst.
- Sentanu.E., (2012). Quantum Ikhlas; TeknologiAktiviasiKekuatanHati, Jakarta: PT. Elex Media Komputindo.
- Sudarmojo.A.H., (2009). MenyibakRahasia SAINS BUMI dalam AL-QUR'AN, Bandung: Mizania
- Suparno.P., (1997). FilsafatKonstruktivismedalamPendidikan, Yokyakarta: Kanisius.
- Suwarno.P.J.,Suparno.P., danRahmanto.B., (1998). PendidikanSains yang Humanistis, Yokyakarta: Kanisius
- Syafii.A., (2009). Kritik Islam TerhadapTeoriEvolusi Darwin.*JurnalHunafa*, Vol.3, No.3, 263-274.
- Tamuri.H.,danRahimi.N.M., (2011). KaedahPengajaranandanPembelajaranPendidikan Islam, Bangi: Penerbit UKM
- Toharudin.U.,Hendrawati.S., danRustaman.A., (2011). MembangunLiterasiSainsPesertaDidik, Bandung: Humaniora.
- Yahya.H., (2003). The Collapse of the Theory of Evolution in 20 Questions (terjemahan), Surabaya: RisalahGusti.

## CHARACTERISTICS OF FUNCTIONAL PROPERTIES OF BEANS PROTEIN RESULTED EXTRACTION OF HYDROCHLORIC ACID

Dedin F Rosida <sup>1)</sup>, Nur Hapsari <sup>1)</sup>, Sri djajati <sup>1)</sup>, Erdianti <sup>2)</sup>

1) Faculty of Industrial Technology - UPN "Veteran" Surabaya, East Java, Indonesia,

2) Food Technology UPN "Veteran" Surabaya, East Java, Indonesia,

Email: [rosy.upnsby@gmail.com](mailto:rosy.upnsby@gmail.com)

### abstract

Kind of beans locally as cowpea (*Vigna unguiculata*), green beans (*Phaseolus radiates L.*) and red beans (*Phaseolus vulgaris L.*) has a protein content ranging from 20% -30% so it can be used as a substitute for soy protein concentrates. This study aims to determine the functional properties of protein concentrates local nuts using hydrochloric acid extraction. Using hydrochloric acid concentration of 3%, 5% and 7%. The results showed that the optimal protein concentrates obtained from the green beans in the extraction process using hydrochloric acid 3%. The results of proximate analysis of protein concentrates ie protein content (21.67%), fat content (1.69%), water content (10.36%), ash content (1.14%) with the functional properties of the protein concentrates Bulk density (0.79 g / mL), oil absorption capacity (2.09 mL / g), water absorption (2.73 mL/g), power foam (4.20%) and emulsion capacity (23.62%). Results optimal protein concentrates from cowpea obtained in the extraction process using hydrochloric acid 7%. The results of proximate analysis of protein concentrates ie protein content (21.21%), fat content (1.61%), water content (12.98%), ash content (1.10%) with the functional properties of the protein concentrates bulk density (0.77 g/mL), oil absorption capacity (1.82 mL/g), water absorption (2.73 mL/g), power foam (0.97%) and emulsion capacity (5.38%). Results optimal protein concentrates obtained from red beans in the extraction process using hydrochloric acid 3%. The results of proximate analysis of protein concentrates ie protein content (21.18 %), fat content (2.07%), water content (10.23%), ash content (1.06%) with the functional properties of the protein concentrates bulk density (0.75 g/mL), oil absorption capacity (1.91 mL/g), water absorption (3.67 mL/g), power foam (1.00%) and emulsion capacity (5.61%)

Keywords: green beans, cowpea, red bean and hydrochloric acid

### Introduction

Types of beans such as cowpea (*Vigna unguiculata*), green beans (*Phaseolus radiates L.*) and red bean (*Phaseolus vulgaris L.*) can be used as a substitute for soybean. The content of protein and amino acids that resemble soy beans are potential local nuts as an alternative source of vegetable protein concentrates to replace soy products. Beans can be used as a product of protein concentrates to be applied to various types of food products. Bridson (1995) state That the hydrolysis of proteins, which breaks them down to their constituent amino acids and peptides, can be achieved by the use of strong acids, strong bases or proteolytic enzymes, there are three main methods of hydrolysis of proteins[

Separation of proteins from fat, water and reducing sugar produces a product that is resistant to storage. Separate proteins (concentrates) forms paste or powder, and has a higher protein content than the original material. The principle of protein isolation comprises the steps of protein extraction in the extraction medium, removal of insoluble material by centrifuge, filtration, combination, recipitation, washing and drying concentrates (Natarjan, 1980 in Kartika, 2009). Principles used to isolate total protein is whole bean protein precipitation at isoelectric point is pH where the entire protein clumping. Selection of acidic as pH during extraction where the majority of negatively charged amino acids at pH above the isoelectric point, like charges tend to repel, causing minimumya interactions between amino acid residues which means to increase protein solubility (Cheftel et al , 1985).

Protein extraction capability is influenced by several factors, including particle size, flour age, previous heat treatment, dilution ratio, pH and ionic strength of the medium extraction (Kinsella, 1979). Hydrochloric acid is a strong acid because it fully dissociates in water and harmless compared to other strong acids, non-reactive and non-toxic. Hydrochloric acid in the medium concentration is

stable enough to be stored and continue to maintain concentration. Therefore, hydrochloric acid is an acid reagent which is very good and is often used in chemical analysis to hydrolyze samples analysis. The influence of the isoelectric point is the value of a protein that gives an important influence on the biochemical properties of proteins that can be used in the process of purification and electrophoresis (Poejadi, 1994). The charge of a protein depends on the pH value of the medium where he is. At the isoelectric point, a protein showing repulsion least because the protein will have the lowest solubility and easy to settle. These characteristics are very useful in the process of protein crystallization. When the pH of the solution reaches a certain isoelectric point, the protein will precipitate and separate from other proteins that have different isoelectric points.

## **Methodology**

### **Beans defatted flour**

Beans sorted and weighed. Beans soaked in water for 4 hours at a ratio of 1: 3 was then performed by boiling for 30 minutes. Beans shelled and dried in a dryer 50 °C for 3 h. Beans mashed with a disk mill and fat extracted with an organic solvent hexane 1: 4 for 4 h gradually. Defatted beans flour dried at 50 °C for 6 h.

### **Beans protein concentrates**

Defatted flour was suspended with distilled water 10 g / 100 mL and extracted using hydrochloric acid concentration of 3%, 5% and 7% with a ratio of 1: 5 with pH adjustment 4 - 5. The suspension was heated with a water bath at 50 °C for 1 hour. After cold it neutralized with 1 N NaOH solution. Suspension neutral conditions was centrifuged at 3000 rpm for 25 minutes. The filtrate was centrifuged again at 3000 rpm for 25 minutes. The first and second precipitate washing three times with water 80 °C and dried on temperature 50 °C for 5 h.

### **Analysis of Water Absorption (Lin et al, 1974)**

A total of 1 g of sample and 10 mL of distilled water for 2 minutes divortex, diiamkan for 1 hour at room temperature and then centrifuged at 3000 rpm for 25 minutes. Filtrate volume was measured.

Water absorption was calculated by the following equation:

$$\text{Water absorption (mL water / g sample)} = \frac{10 \text{ mL} - \text{vol filtrate (mL)}}{W \text{ sample (g)}}$$

### **Analysis of Oil Absorption (Soluski and Fleming, 1977)**

A total of 0.5 g of sample plus 3 ml of soybean oil divortex for 2 minutes and then allowed to stand at room temperature. The mixture was centrifuged at 3000 rpm for 25 minutes. Supernatant was poured into 10 ml measuring cup and observed free oil volume oil absorption measurements performed two repetitions with the following equation:

$$\text{Oil absorption capacity (mL / g sample)} = \frac{3 \text{ mL of oil} - \text{filtrate}}{W \text{ sample (g)}}$$

### **Capacity Analysis and Emulsion Stability (Franzen and Kinsella, 1979)**

A total of 0.5 g of sample and 25 ml of water is set pH to 8 while stirring with a magnetic stirrer for 5 min. A total of 25 ml of the sample solution plus 25 ml of soybean oil was dispersed in a blender for 1 min, then centrifuged at 3000 rpm for 10 min. The volume of the emulsion can be measured by the equation:

$$\text{Emulsion capacity ct} = \frac{V \times 100\%}{V \text{ tot.t}}$$

Specification:

VCT = volume of the mixture emulsifies

Vtot.t = total volume in the tube

The emulsion is formed saved some at room temperature. The volume of the emulsion was observed on the clock to 0.5, 1, 2, 4, 6 and then recorded and emulsion stability curve

### **Capacity and Stability Foam (Widowati et al, 1998)**

A total of 2 g of sample was dissolved in 100 mL of distilled water and homogenized with a magnetic stirrer for ± 1 min . The solution was then adjusted to pH 8 and shaken with waring belnder for 2 min. Foam volume was calculated by the following equation:

$$\text{Foaming capacity (\%)} = \frac{V_{\text{bsd}} \times 100\%}{V_{\text{alp}}}$$

Specification:

$V_{\text{bsd}}$  = volume of foam before whipped

$V_{\text{alp}}$  = initial volume of protein solution

### Preparation and HPLC Analysis of Amino Acid in beans Protein Concentrate

0.1 g sample is taken and added 2 mL of Performat vortex. the mixture was hydrolyzed for 16 h at a temperature of 0 °C. Then added 0.3 mL of 48% HBr and incubated at a temperature of 0 °C for 15 minutes. The solution was dried in a rotary evaporator at 60 °C. The filtrate was pipetted 500 µL and added 40 µm AABA and aquabidest 460 µl. Furthermore, a solution of 10 µl pipette and added 70 µl AccQ-Fluor Borate and vortex. Fluor AReagent 20 µl vortex taken and then allowed to stand 1 '. Reagents were incubated at 55 °C for 10 '. Samples prepared injected into the HPLC. HPLC conditions : colom AccQtag column (3.9 x 150 mm), temperature 37 °C, mobile phase acetonitril 60% - Accq Tag Eluent A, Gradient system, flow rate 1.0 mL/min, detector Fluorescence, excitation 250 nm, emission 395 nm and 5 µl injection volume.

## Result and Discussion

### Protein content

The highest protein content of green beans at a concentration of 3% hydrochloric acid in the amount of 21.67% db was at pH 5.3. The highest protein content of cowpea at 7% hydrochloric acid concentration of 21.21% db was at pH 4.2, while the highest protein content of beans at a concentration of 3% hydrochloric acid 21.18% db was at pH 4.9. Proteins can be denatured by the addition of an acid solution and heating to food that has a high protein content. Protein levels at each concentration of hydrochloric acid and nuts can be seen in Figure 1

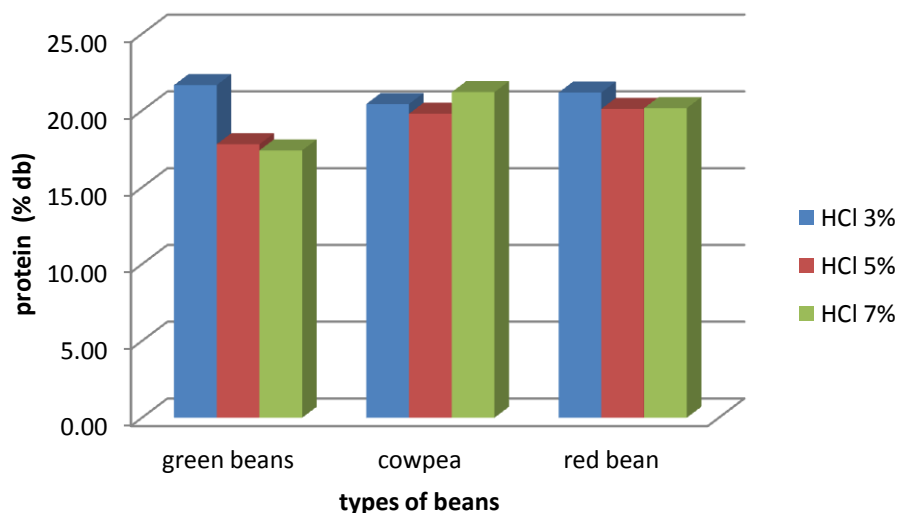


Figure 1. Protein content of beans protein concentrate

Lehninger (1982) states that the effect of pH based on the difference in affinity of the most powerful among the same protein occurred at the isoelectric pH while the pH above and below the isoelectric point, the protein will change the charge that causes decreased affinity between protein molecules, so readily biodegradable molecules. The further distinction pH of the isoelectric point of the protein solubility increases. Kurniati (2009) which states that the protein extraction using a strong acid (HCl) resulted in the addition of excess H<sup>+</sup> ions that neutralize the protein and the achievement of the isoelectric pH. Ionic properties of the protein if the protein contains a lot of the acid has a low isoelectric point. Suhardi (1992) states the isoelectric point is the pH in the form of amphoteric ( cations and anions ) and at the isoelectric point of the protein solubility decreases and reaches the lowest number, the protein will precipitate and agglomerate.



Table 1. Amino acid composition of cowpea beans protein

No	Amino acid	Result (%)
1	Aspartate	1.34
	Glutamate	2.37
	Serin	1.06
	Glycine	0.79
	Histidine	0.63
	Arginine	1.23
	Threonine	0.86
	Alanine	0.76
	Proline	0.71
	Falin	1.06
	Tyrosine	0.67
	Isoleucine	0.93
	Leucine	1.72
	Phenilalanin	1.42
	Lisin (Lysine HCl)	1.10
	Cystine	0.02
	Methionine	0.29
	<b>Total</b>	<b>16.98</b>

The cowpea (*Vigna unguiculata* L.) contained 41.99% globulin, 10.11% albumin, and 7.81% glutelin (Shoshima et al ., 2005). On the other hand, in the species *Vigna aconitifolia* L., the second principal group is the glutelin fraction (27.83 ± 0.27%), followed by albumins (5.06 ± 0.27%) (Sathe; Venkatachalan, 2007).

In the protein concentrate of baru nuts, the globulin fraction increased and the albumin decreased, while the glutelins remained practically constant. The prolamin fraction was not detected in the concentrate. The dialyzable fraction, 9.27% in the flour, increased to 22.81% in the concentrate, representing the efficient soluble protein extraction of low molecular weight in salt. The final residue decreased to 10.94% in the defatted flour and 2.12% in the concentrate (Guimarães et. al, 2012)

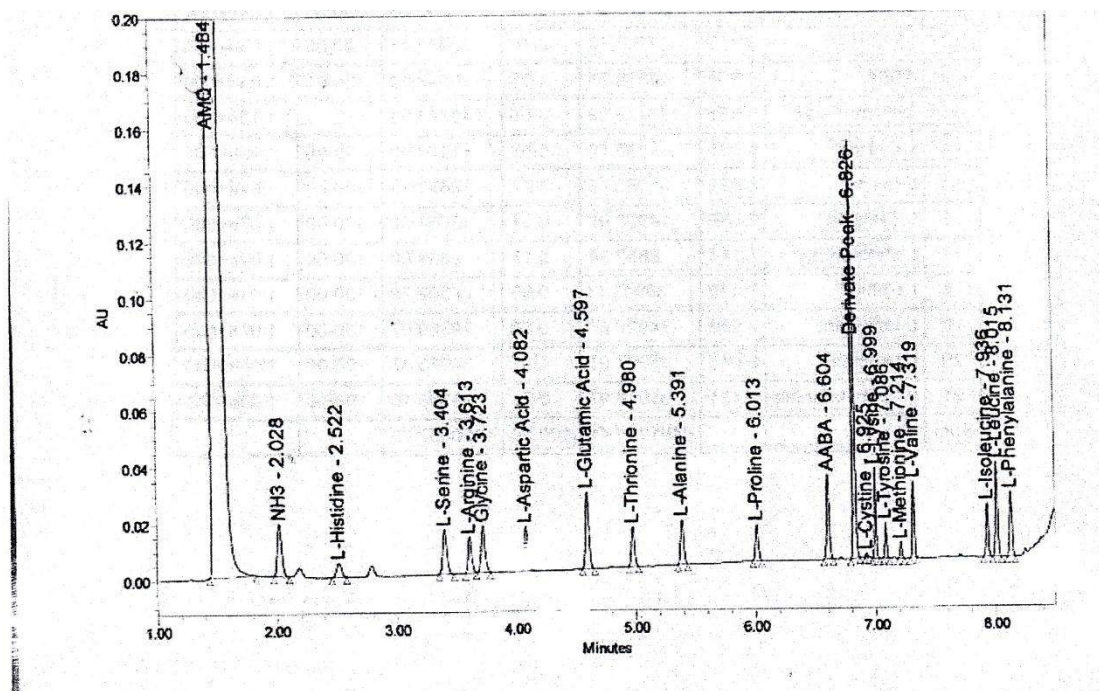


Figure 2. Chromatogram of cowpea beans amino acid

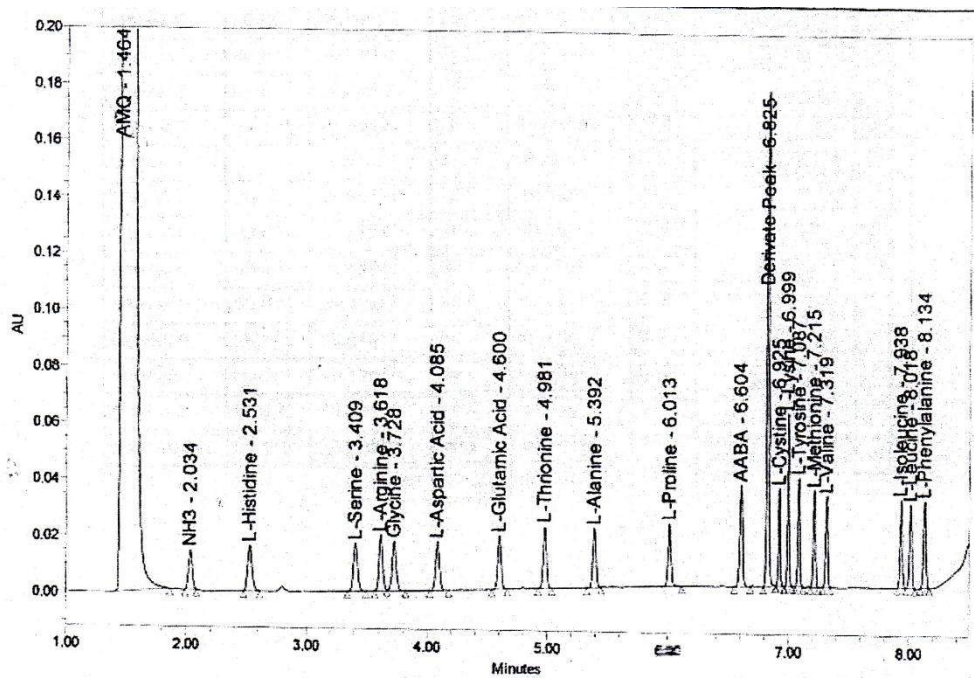


Figure 3. Chromatogram of amino acid standart

Acid or base treatment of plant (soybean, corn) or animal (casein) proteins brings about desirable changes in flavor, texture, and solubility. Such treatments also destroy toxins and trypsin inhibitors and are used to prepare protein isolates (Friedman and Liardon, 1985)

One of the principals advantages of acid as compared with base hydrolysis is that the optical activity of the amino acids is not destroyed in the process (Haurowitz, 1955), on the other hand, acid hydrolysis destroys tryptophan and partially destroys cystine, serine, and threonine. Asparagine and glutamine are converted to their acidic form (Bridson, 1995; Haurowitz, 1955)

The ash, soluble solids, and polyphenol contents have no influence on their protein digestibility ((Hernández *et al.*, 1997). The comparison between the dietary fiber content of the concentrates and their digestibility values reveals an inversely proportional relationship. Correlation analyses were run on the insoluble, soluble, and total dietary fiber contents (Hernández *et al.*, 1995). Subba Rau *et al.* (1972) concluded that there was an inverse relationship between the ash content, polyphenol content, and soluble solids content and the nutritive value.

### Water Absorption

Water absorption is the ability of the protein to bind water during application of forces, pressure, centrifugation or heating. Factors that affect water absorption wss the protein concentration, pH and ionic strength and thermal effects. Water absorption in each concentration of hydrochloric acid and nuts can be seen in Figure 4.

In Figure 4 shows that the highest rate of water absorption in the green beans at 7% hydrochloric acid concentration was 2.73 mL / g, cowpea at a concentration of 5% hydrochloric acid was 3.13 mL / g, red beans on the concentration of hydrochloric acid 5 % was 4.11 mL / g. The absorption of red bean protein concentrate has the highest water absorption followed by cowpea and mung bean. Although the value of the functional properties may be quite variable, depending on the technique and conditions of the assays, it can be inferred that the performance of the proteins in the defatted flour was similar to that of soybean (223%, Sosulski (1976) and 175% Sosulski; McCurdy (1987))

The pH 5 showed the lowest protein solubility, slightly more than 20%, that this pH value is near the isoelectric point of protein isolates from amaranth (4.6) resulting in aggregation and precipitation of the great part of the proteins (Mizubuti, 2000).

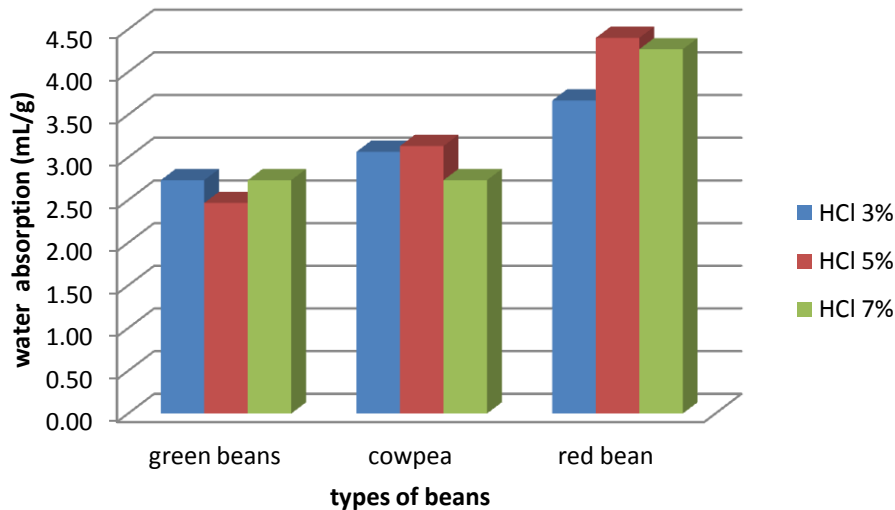


Figure 4. Water absorption of beans protein concentrate

Protein solubility is an important factor for the optimization of functional properties. A more soluble product is also more easily formulated for some foods. Hence, almost all concentrates and isolates are neutralized and sold as proteinates. The major form is sodium, potassium, and calcium proteinate, but other proteinates are available (Wolf; Cowan, 1971).

Water absorption ability of a protein concentrate, caused by a polar amino acid is more dominant. Suwarno (2003) stated that the binding of water depends on the composition and conformation of protein molecules. The interaction between water and polar groups of the side chains of proteins can occur through hydrogen bonds. The amount of water that can be retained by the protein depends on the amino acid composition, surface hydrophobicity, and processing. The amount of water that is bound to be increased if the polarity of the protein increases. water absorption related to the amount of polar amino acid groups present in the protein molecule. Polar amino acid groups, such as hydroxyl, amino, carboxyl, and sulfhidril provide hydrophilic properties of the protein molecule that can absorb and bind water.

Budijanto, et al (2011) stated that the amino acid composition of proteins affect water absorption properties of protein concentrates. Protein concentrates contain many polar amino acids (glutamic acid, aspartic acid and lysine) so as to improve the ability of water absorption. The amount of water that is bound by a protein depends on the composition of the polar amino acids. Sorgentini *et al.* (1991) has studied hydration properties of soy protein isolates are particularly good in products with a high degree of protein denaturation. Surowka K., Żmudzinski D. (2004) The extruded protein concentrates belong hydration properties are also affected by non protein constituents, chiefly pectic substances and hemicelluloses. Surowka (1997) states the hydrolysis leads to a deformation of the protein matrix and, partly, to the transfer of some amount of protein substances into the solution, it should, theoretically, decrease hydration capabilities of the extrudates protein.

Protein solubility is influenced by the hydrophilicity/hydrophobicity balance, which depends on the amino acid composition, particularly at the protein surface (Moure et al.,2006). The presence of a low number of hydrophobic residues; the elevated charge and the electrostatic repulsion and ionic hydration occurring at pH above and below the isoelectric pH favour higher solubility. Protein solubility is also influenced by production method and in particular by denaturation due to alterations in the hydrophobicity/hydrophilicity ratio of the surface. A highly soluble protein is required in order to obtain optimum functionality required in gelation, solubility, emulsifying activity, foaming and lipoxygenase activity (Riaz, 2006). Soluble protein preparations are easier to incorporate in food systems, unlike those with low solubility indices which have limited functional properties and more limited food uses.

## Oil Absorption

Oil absorption capacity is physically oil binding by proteins. Oil absorption capacity at each concentration of hydrochloric acid and nuts can be seen in Figure 5. In Figure 5 shows that the highest oil absorption value of green beans at a concentration of 3% hydrochloric acid in the amount of 2.09 mL / g, cowpea at a concentration of 5% hydrochloric acid for 2,01ml / g and red beans with hydrochloric acid concentration of 3% by 1,91ml / g. In the green bean protein concentrate highest ability to absorb oil. It is alleged in the green bean non-polar amino acids such as phenylalanine dominant so that the absorption ability of oil / fat increased. Lin et al (1974) state oil absorption capacity of a protein depends on its structure. Structure which is the type of lipoprotein lipolytic suspected to contain a non-polar amino acids (glycine, alanine, phenylalanine, tryptophan, valine, leucine and proline) with a protein content of nonpolar branch dominant, contributing to the increase in oil absorption capacity.

Oil absorption in the defatted flour was in the literature for soybean 130% and 56%. The water absorption capacity for the defatted flour of peas and fava beans was 78 and 72%, respectively, and the values found for oil were 41 and 47% (SOSULSKI; McCURDY, 1987).

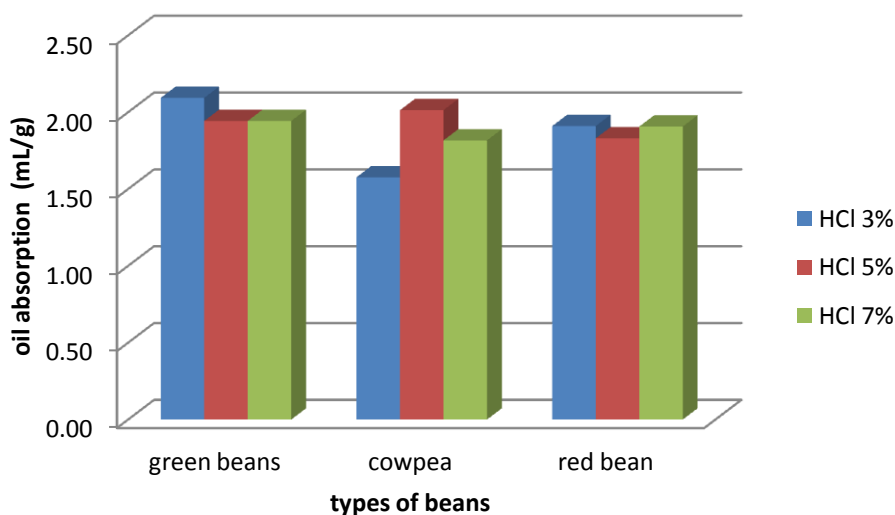


Figure 5. Oil absorption of beans protein concentrate

Oil absorption ability of a protein can be caused by the denaturation process in the protein so that the opening of the conformational structure of the protein. This is in accordance with the opinion Suwarno (2003) which states that the denaturation of the protein can increase the protein's ability to bind fat due to the opening of the protein structure that describes the amino acids that are non-polar. According Zayas (1997) stated that the oil absorption capacity of a protein is affected by sources of protein, the protein particle size, shape processing, other additives, temperature and degree of denaturation.

Kartika (2009) which states that the structure of the proteins that are lipolytic are the type of lipoprotein which is thought to contain a non-polar amino acids (glycine, alanine, phenylalanine, tryptophan, valine, leucine and proline) with a protein content of nonpolar branch dominant, contributing to an increase in absorption of oil.

## Foam Power

Foam is a two-phase system of air cells are separated by a thin continuous layer of liquid. Foam power demonstrates the ability of proteins to produce a foam surface area / unit weight of protein to stabilize the film or coating the surface of the internal and external forces. Power foam at each concentration of hydrochloric acid on the type of bean can be seen in Figure 6.

In Figure 6 shows that the value of the highest scum on green beans at a concentration of 3% hydrochloric acid is equal to 4.20%, followed by red beans on the use of HCl 7%. This was due to the concentration of hydrochloric acid 3% opening of bonds in the protein molecule, resulting in the intake air that expands protein. Foaming ability increases when the protein concentration increased, along



with the results of this study indicate the concentration of hydrochloric acid 3% have a high protein value.

Foam formation mechanism begins with the opening of the bond in the protein molecule so that the protein chain becomes longer, later air enters open between protein molecules and proteins to survive so that the volume expands. Zayas (1997) states that the foaming ability increases when the protein concentration also increased because it will increase the thickness of the interfacial layer of film on Cherry and Mc Watters, (1981).

The increase in the proportion of protein in the concentrate appears to influence positively the formation capacity and stability of baru foam due to the presence of soluble sugars, which increase viscosity (Guimaraes et al 2012).

In contrast, the foam formation capacity of the winged bean (*Psophocarpus tetragonolobus* (L.) DC) showed a 76% volume increase at pH 4.6 and 150% at pH 9.8 for the concentrate, while for the defatted flour, foam formation reached 52% at pH 6.0 (Narayana; Narasinga, 1982). Soybean (*Glicina max* (L.) Merrill) flour and protein concentrate had an increase of 70 and 170%, respectively, in the volume of foam (LIN et al., 1974). Protein concentrates of the "carioca" variety of the common bean showed a low foam stability at 30, 60, 90, and 12 minutes with values of 1.28, 3.18, 4.43, and 6.63%, respectively (Donadel; Ferreira, 1999).

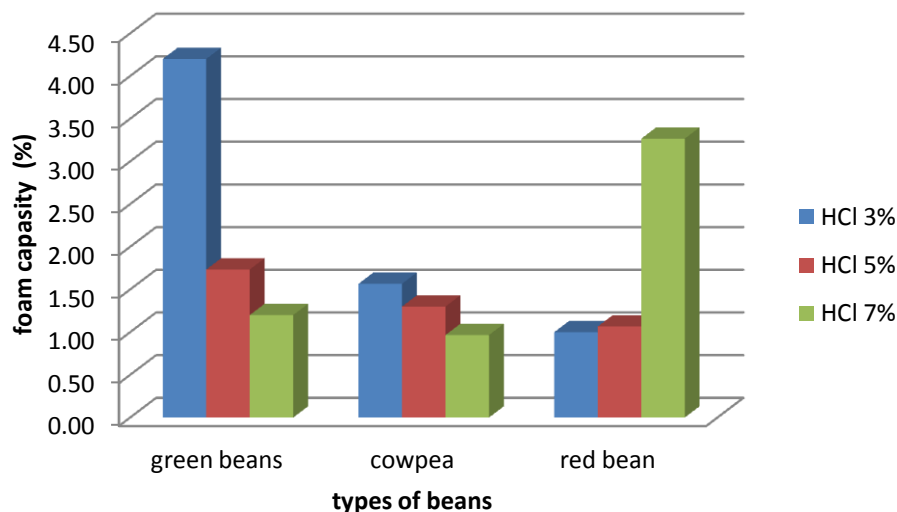


Figure 6. foam capacity of beans protein concentrate

Declining foam (0.97%) in cowpea with the use of hydrochloric acid 7% and red beans (1.0%) on the use of HCl 3% due to have a high fat content so weaken the interaction of proteins in the foaming and instability film is formed. foam instability influenced by the presence of residual fat on protein concentrate which causes the lining of the film is too thin to stabilize bubbles (Zayas, 1997). Dedin et al (2013) has studied that the highest foam capacity of leucaena concentrate at leather pineapple waste enzyme treatment of concentration of 100 mg / 100g with a long incubation of 48 hours of 8%. Dedin et al (2014, unpublished) has studied the value of the highest foam concentrates protein membrane filtration results in pressure 3.66 atm with a separation of 45 minutes is 9.8%. The results of this study, the value is smaller than previous studies. The small number of foam power these results allegedly by hydrochloric acid extraction are not coagulated at the protein isoelectric point so much that shipped with the filtrate.

Soy proteins were suggested to have poor foaming properties due to their large, compact structure (GERMAN *et al.* 1985). Enzyme treatment increased the height of foam (HF), but foam stability was markedly decreased in each instance. The foam stability of the unhydrolysed protein of DSF was 148 min/100 mm while that of the hydrolysates in the presence of Alcalase, Flavourzyme and Noozym after 8 hrs was 17.2, 32.4 and 2.8 min/100 mm, respectively (Hrcková 2002). The paper by TURNER (1969) indicated that to make a stable foam partially hydrolysed protein is needed to increase the foam expansion and some larger protein components are needed to stabilize the foam. The foaming ability of protein improved in hydrolysis in the presence of Alcalase but foam stability decreased. When the smaller peptides produced after hydrolysis were separated by ultrafiltration, the foam stability of permeate was improved (PANYAM & KILARA 1996). In the present study, there are no

larger protein components present in the hydrolysates so that they could not stabilize the foam. Enzymatic hydrolysis of soy proteins can be used to produce a product with good whipping properties (TURNER 1969; GUNTHER 1972).

## Capacity emulsion

Emulsions are, from the physicochemical point of view, thermodynamically unstable systems rapidly or slowly separating into two immiscible phases according to The kinetic stability. Mechanisms of physical destabilisation of emulsions include oil droplets size variation processes such as flocculation, and Coalescence and particle migration phenomena like sedimentation and creaming (Comas et al. 2006). Emulsion is a dispersion or suspension of a liquid in another liquid, the molecules do not dissolve each other. Emulsion capacity on each bean protein concentrate can be seen in Figure 7.

In Figure 8 shows the value of the highest emulsion capacity of green beans group on the use of hydrochloric acid 3% at 23.62%. This is because at a concentration of 3% hydrochloric acid emulsion activity increases with increasing levels of protein and fat content, resulting in fat-water emulsion is formed. Lowest emulsion capacity cowpea at 7% hydrochloric acid concentration of 5.38% and red beans (5.61%) on the use of 3% hydrochloric acid. This is due to an imbalance of protein amino acid number hydrophilic and lipophilic emulsifier resulting labor power can not be bound either in oil or water, forming a matrix that is less resulting in a less stable emulsion.

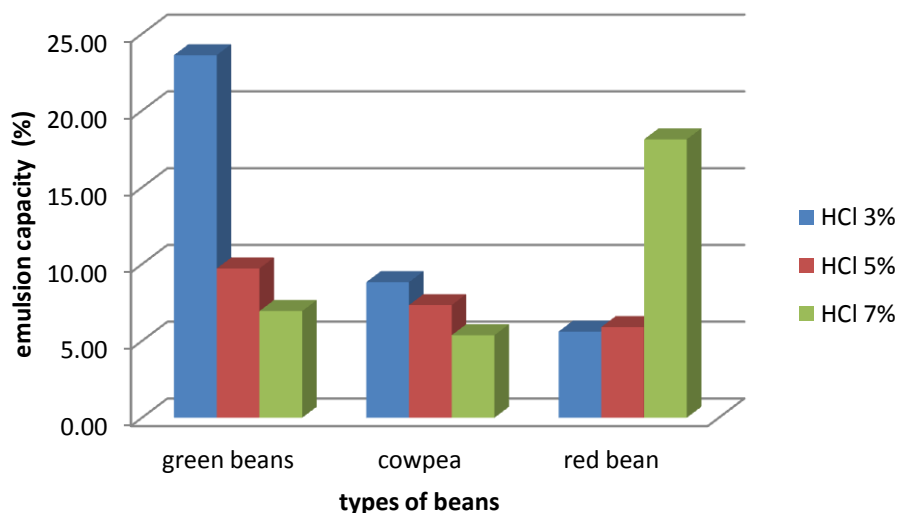


Figure 7. Emulsion capacity of beans protein concentrate

Zayas (1997) which states the balance of hydrophilic-lipophilic amino acid is closely connected with the ability to lower the surface tension as a function of emulsion formation. Components of hydrophilic-lipophilic amino acid protein capable of binding to the oil and water as well with water mechanism would bind the hydrophilic chain and oil on the lipophilic chain. Wolf and Cowman, (1971) which states that the protein has a role in the activity of the emulsion is formed emulsion of fat and water, protein will gather in fat-water interface and the surface low pressure. the solubility and emulsifying properties of Soy Protein Isolate were closely correlated in the acid condition (Lixia Mu et al.2011).

Defatted protein concentrate of baru nuts (*Dipteryx alata* Vog) flour, the emulsifying activity was  $51.00 \pm 0.76\%$ , and the emulsion stability was  $50.0 \pm 0.47\%$  (Guimaraes et al. 2012). The emulsifying activity of the protein concentrate of the "carioca" variety of the bean (*Phaseolus vulgaris*) was very close to that of baru,  $50.16\%$  (Donadel; Ferreira, 1999), while the emulsion stability of this bean was lower than that of them, reaching  $23.6\%$ .

## Conclusion

Breaking down some of the amino acids, completely and breaking down some other amino-acids partially. Functional properties of green beans in oil absorption, foam power and emulsion capacity superior than cowpea and red beans.

## Acknowledgments

This research was supported entirely by the Directorate General of Higher Education, Ministry of Education and Culture

## Reference

- Bridson, E.Y., . 1995. "The Oxoid Manual", 7th ed., United Kingdom
- Comas D.I., Wagner J.R., Tomás M.C. 2006: Creaming stability of oil in water (O/W) emulsions: Influence of pH on soybean protein-lecithin interaction. *Food Hydrocolloids*, 20:990–996.
- Donadel, M. E.; Ferreira, S. H. P.1999. Propriedades funcionais de concentrado protéico de feijão envelhecido. *Ciência e Tecnologia de Alimentos*, v. 19, p. 1-13
- Friedman, M., and R. Liardon. 1985. *J. Agric. Food Chem.*, 33, 666
- German J.B., O'neill T.E., Kinsella J.E. 1985: Film forming and foaming behavior of food proteins. *JAOCS*, 62:1358–1366.
- Gunther R.C. 1972: Protein-type foaming agent. Canadian Patent 905742.
- Guimarães, R.C.A., Favaro, S.P., Viana, A.C.A., Neto, J.A.B., Neves, V.A, Honer, M.R., 2012. Study of the proteins in the defatted flour and protein concentrate of baru nuts (*Dipteryx alata* Vog). *Ciênc. Tecnol. Aliment.*, Campinas, 32(3): 464-470,
- Haurowitz, F., "Biochemistry". 1955. An Introductory Textbook, John Wiley & Sons, Inc., New York
- Herna'ndez, T.; Marti'nez, C.; Herna'ndez, A. 1995. Influence of solvent extraction on the dietary fiber fractions of alfalfa protein concentrates. *J. Sci. Food Agric.* 68, 187-190.
- Herna'ndez,T; Marti'nez C, Herna'ndez, A, and Urbano, G. 1997. Protein Quality of Alfalfa Protein Concentrates Obtained by Freezing. *J. Agric. Food Chem.* 1997, 45, 797-802
- Hrcková M., Rusnáková M., Zemanovic J. 2002: Enzymatic hydrolysis of defatted soy flour by three different proteases and their effect on the functional properties of resulting protein hydrolysates. *Czech J. Food Sci.*, 20: 7–14.
- Lehninger, A.L. 1990. Basic - basic Biochemistry. The publisher. Jakarta
- Lin, M. J. Y. et al. 1974. Certain properties of sunflower meal products. *Journal of Food Science*, v. 39, p. 368-370, 1974
- Lixia Mu, Haifeng ZHao, Mouming ZHao, Chun Cui and Liya Liu. 2011. Physicochemical Properties of Soy Protein Isolates-Acacia Gum Conjugates. *Czech J. Food Sci.* Vol. 29, 2011, No. 2: 129–136
- Moure, A.; Sineiro, J.; Domínguez and Parajó, J. C. 2006. Functionality of oilseed protein products: A review. *Food Research International* 39:945-963.
- Narayana, K.; Narasinga, R. 1982. Functional properties of raw and heat processed winged bean (*Psocarpus tetragonolobus*) flour. *Journal of Food Science*, v. 47, p. 1534-1538,1982.
- Panyam D., Kilara A. 1996: Enhancing the functionally of food proteins by enzymatic modification. *Trends Food Sci. Technol.*, 7: 120–125.
- Riaz, M. N. 2006. *Soy Applications in Foods*. London: CRC Taylor and Francis pp. 39-226.
- Sathe, S. K.; Venkatachalam, M. 2007. Fractionation and biochemical characterization of moth bean (*Vigna aconitifolia* L.) proteins. *Science Direct*, n. 40, p. 600-610.

- Shoshima, A. H. R. et al. 2005. Digestibilidade in vitro das proteínas do caupi (*Vigna unguiculata* L. Walp) "Var. Br-14 Mulato." Efeito dos fatores antinutricionais. *Brazilian Journal of Food Technology*, v. 4, p. 299-304,
- Sorgentini, D.A., Wagner J.R., Arrese E.L., Anon M.C. 1991: Water imbibing capacity of soy protein isolates: influence of protein denaturation. *J. Agric.Food Chem.*, 39: 1386–1391.
- Sosulski, F. 1976. Functional properties of rapeseed flours concentrates and isolate. *Journal of Food Science*, v. 41, p. 1349-1352, 1976. <http://dx.doi.org/10.1111/j.1365-2621.1976.tb01168.x>
- Sosulski, F.; Mccurdy, A. R.1987. Functionality of flours, protein fractions and isolate from field peas and faba bean. *Journal of Food Science*, v. 52, p. 1010-1014, 1987. <http://dx.doi.org/10.1111/j.1365-2621.1987.tb14263.x>
- Subba Rau, B. H.; Ramana, K. V.; Johnson, C. B. 1972. Studies on nutritive value of leaf proteins and some factors affecting their quality. *J. Sci. Food Agric.* 23, 233-245.
- Surowka K. 1997: Wpływ składników mąki sojowej na właściwości fizykochemiczne spożywczych preparatów białkowych z soi. *Zeszyty Naukowe Akademii Rolniczej w Krakowie, Rozprawy Nr.* 232.
- Surowka K., Żmudzinski D. 2004: Functional properties modification of extruded soy protein concentrate using Neutrase. *Czech J. Food Sci.*, 22: 163–174.
- Turner J.R. 1969: Modified soy protein and preparation thereof. U.S. Patent 2, 489, 208.
- Wolf, W. J.; Cowan, J. C. 1971. Soybeans as a food source. *CRC Critical Reviews in Food Technology*, v. 1, p. 81-158, 1971.



# Se'i Tradition for Pregnant Women in Peoples of East Nusa Tenggara

<sup>1</sup>*Shrimarti Rukmini Devy*, <sup>2</sup>*Riris Diana Rachmayanti*, <sup>3</sup>*Christina Rosanti Nenotek*

<sup>1</sup> Public Health Faculty in Airlangga University, s\_r\_devy@ yahoo.co.id, 081330704924

<sup>2</sup> Public Health Faculty in Airlangga University,

<sup>3</sup> Public Health Faculty in Airlangga University,

## Abstract

The first priority of health sector in Indonesia is maternal health. This is supported by the data that the MMR is higher, 359 every 100,000 live births. One of the causes of maternal death is mistakes in postpartum care. Variety of traditional way that done by the people to take care of postpartum mothers, for example *se'i* tradition, which done by Timor tribe in NTT. In reality, the implementation of the tradition is contrary to the modern medical care, thus resulting in health problems for postpartum mother. However, this should not discourage the people to do their intention, although the government has banned the tradition. In order to get the right solution requires analysis related community public opinion, especially pregnant women about the benefits *se'i* tradition. In order to get the right solution is required the analysis related to community public opinion about the benefits *se'i* tradition, especially in pregnant women. The purpose of this study refers to the theory Snehendu B.Kar., to describe it. This study used a qualitative approach with study of phenomenology, the technique of data collection were use in-depth interviews, observation, and FGD while the analysis of the data used content analysis. The subjects were 15 pregnant women with gestational age trimester 2 & 3 while the informants for this research is the husband, family, and community leaders (totaly14 person). The results showed that people in the village Pollo and Bena, District of South Amanuban, do the *se'i* tradition because, 1.) intention behavior factors: accelerate the recovery of post-birth mother in order to get stronger quickly, can eliminate the dirty blood clots in order not to become fetal back, and avoid white blood rose to the head, 2). social support factors include the availability of support, especially from the family to do *se'i*, 3) accessebility of information factors, which is the family (mother and mother-in-law) who were first introduced the *se'i* tradition, 4.) personal autonomy factors, includes the authority to implement *se'i* tradition on the birth mother or mother-in-law, 5.) action situation factor, include the possibility of mother implement *se'i* for 40 days, this activity is strongly supported because there are people who replaces the mother doing domestic work and only the husband works for a living during the mothers do *se'i*, so she can focus on implement this tradition.

Keywords : *se'i tradition, pregnant women, postpartum care*

## Introduction

The first priority of health sector in Indonesia is maternal health. This is supported by the data that the MMR is higher, 359 every 100,000 live births. One of the causes of maternal death is mistakes in postpartum care. Variety of traditional way that done by the people to take care of postpartum mothers, for example *se'i* tradition, which done by Timor tribe in NTT. In reality, the implementation of the tradition is contrary to the modern medical care, thus resulting in health problems for postpartum mother. However, this should not discourage the people to do their intention, although the government has banned the tradition. In order to get the right solution requires analysis related community public opinion, especially pregnant women about the benefits *se'i* tradition.

The purpose of this study refers to the theory Snehendu B.Kar, analyze the the implementation of *se'i* tradition for pregnant women. Special purpose of this study:

1. Identify the character of pregnant women.
2. Analyze the Behavior Intention factors in pregnant women related to *se'i* tradition.

3. Analyze the Social Support factors related to pregnant women se'i tradition.
4. Analyze the factors Accesibility of Information on pregnant women related to se'i tradition.
5. Analyze the Personal Autonomy factors in pregnant women related to se'i tradition.
6. Analyze the Action Situation factors in pregnant women related to se'i tradition.

## Research Method

This study used a descriptive research design. The study design was chosen because it aims to describe the results of the implementation of community analysis in the community in the district of South Amanuban. This study used a qualitative approach with a phenomenological study.

Research carried out in the district. Amanuban Sel., Kab. TTS, Prop. NTT. The reason for choosing these locations because people still implement se'i tradition. The research was conducted August to November 2014.

The purpose of this study refers to the theory Snehendu B.Kar., to describe it. This study used a qualitative approach with study of phenomenology, the technique of data collection were use in-depth interviews, observation, and FGD while the analysis of the data used content analysis. The subjects were 15 pregnant women with gestational age trimester 2 & 3 while the informant of this research is the husband, family, and community leaders (totally 14 peoples).

## Results

Se'i tradition is a tradition that is carried out by tribal communities in the region of East Nusa Tenggara, particularly in the district of South Amanuban. In the tradition, a mother who has given birth to a baby will be placed in a bed with base of mat and board on the bottom of the bed and also placed coals of fire for 40 days. In the first four days, the mother and baby should not leave the bed but on the fifth day they could leave the bed but still doing the roasting with the time could not be determined in the morning or afternoon only and the duration according to the their needs. According to local people, the implementation of se'i tradition is to warm the mother and baby. The implementation of roasting can be done outdoors in a small house (round house) which is located apart from the residence or in the house. After the government policy on the implementation of the prohibition of se'i, more se'i tradition implemented in the main house. Its location in the kitchen or in the room so it is much easier in the roasting process.



**Figure 1** The Implementation of Se'i Tradition

Figure 1 shows the implementation of the tradition se'i of a mother and her baby were in bed with coals of fire underneath them. Looked on the side is a mother-in-law who participate in implementing se'i tradition as a support in preparing all the needs of postpartum mothers. The role of mother and mother-in-law is very important because in the general postpartum mother is still living at their parents or in-laws home for several days. According to the head of the village, the mother who did se'i prefer to not use drugs from hospital and choose the traditional medicine. However, the habit has been started to decrease since 2000 because there were suggestions from the Public Health Centre (Puskesmas). The following are excerpts of quotations.

*"They encourage each mother who gave birth had to be helped by medical personnel. Although sometimes there is no time to give birth in a hospital, but at home the medical officer give their help."*(Pollo's village chief).

The research of Handayani [4] obtained results that according to local community leaders, the implementation of se'i on postpartum mothers are activities that must be done by the mother and the aim to strengthen the mother's body because it is derived from the inherited culture. The community concept on the relationship between the roast with postpartum maternal health is only based on the knowledge gained from experience that be taught hereditary.

Based on in-depth interviews with the community leaders, the implementation of se'i tradition can accelerate the recovery of postpartum mother and can bleed the dirty blood. The dirty blood be understood can be clotted in the mother's body if not removed, which can eventually returned to be the fetus. As stated by the Traditional healer (dukun) in the following interview.

*"So this mom explained, if se'i it is required because it is already habit for long ago, the parents in the past with their knowledge, knows that se'i can accelerate recovery, it can quickly make mother more powerful, and possibly make the dirty blood bleed quickly. If the dirty blood is not bleed quickly, according to the parent view, that postpartum mother will get pregnant again in a short time."*(Traditional Healer A, 38 years)

The statement was supported by the answers of the mothers who also stated that the lump if not removed can become returned fetus. The the dirty blood clots believed derived from the rest of menstrual blood pile. The following are excerpts of quotes

*"The dirty blood while we menstruation when we were young, it hasnot gone with cold water bath, so the dirty blood was stacked, blobs-like child will be lost."* (Mother-in-Law EN, 52 years)

A senior midwife has the opinion that people do the se'i tradition to heal the wounds that exist in the uterus after childbirth.

*"E, they do se'i because by doing that, e circumstances postpartum mothers in childbirth there was such bleeding and they believed that it must be wound inside the uterus. So with the roast, it can heal the wounds that exist in the uterus."*(Midwife B, 48 years)

According to the Traditional healer, se'i tradition can not be done if pregnant women already receiving treatment from public health centers(Puskesmas).

*"I give an explanation that if you've given birth and get treatment at the clinic, the pain can't be healed with se'i tradition again. If they did the se'i tradition, the child will be sick and the body can be injured."* (Traditional healer A, 38 years)

According to the pregnant mother, if se'i tradition is not conducted, then the white blood will rise to the head so that the mother went mad. Related to this, the midwife gives the following explanation.

*"O it so maybe it's because of malaria, because this area is malaria-endemic areas, maybe the first incidence ocured was not detected, so they assume that because*

*they did not do the se'i tradition so white blood raised and we give meterginiko injection, anti-white blood. We talk nonsense in this community about the anti-white blood, so at home there should not be se'i tradition because the medicine already exists, so that means dongtolabahola means contradiction between them believe.*" (Midwife B, 48 years)

There is another taboo that makes pregnant women is not give birth in a health facility, that is because the mother is ashamed of fear stripped naked and there are restrictions give the baby clothes. While in hospital the baby was given clothes. The community believes that it can make baby death. This is explained by the following health cadres.

*"Then there is again a taboo for them, the baby should not be given clothes, was one of the taboo, or prohibition of the parents in the past. Because if go to the hospital the mother should bring all the baby clothes. Here, after the expiration of 40 days postpartum, infants should be given clothes. Gave birth is hard. So during that time the mother wrap the baby with cloth. That's what makes them not want to give birth in a health facility. Because of the baby clothes."*(Cadres EB)

According Notoatmodjo [6], seeking assistance delivery by health personnel behaviour is much higher in urban areas than in rural areas. While there is no difference between searching delivery assistance by health professionals or with non-medical personnel in rural areas. Such behavior is also associated with socioeconomic level.

Ecological factors include the state of nature, geography, climate, weather, and so on can affect a person's behavior [6]. Based on the interviews and FGD information, one of the reasons that are used by pregnant women to keep doing se'i tradition is cold weather. The following are excerpts of quotes.

*"In my opinion , that should have been abandoned, but that we experienced, we have given education to the mother but because of the cold mother do the se'i. Yes it is cold, so yes sometimes we still can tolerate that, they can made charcoal and just put in, do not create a fire in the room brought in the ashes and put it under the bed so let it warm."*(Cadre \_\_)

*"And the postpartum mother was placed in a round house. Yes the round house, so during the postpartum period they roasted in a round house."*(Midwife B, 48 years)

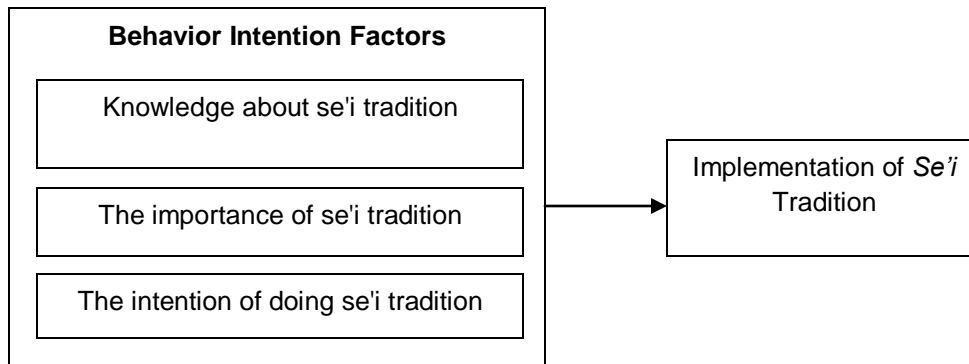


**Figure 2** Round House, The Place for Implement Se'i Tradition

### Analysis of Behavior Intention Factor in Pregnant Mother Associated With Se'i Tradition

Behavior intention is someone's intention to act, in relation with a health or health care. Behavior intention in pregnant women related to the implementation of se'i tradition, includes knowledge about se'i tradition, the importance of se'i tradition for pregnant women, and the intention of doing se'i tradition during the postpartum period.

Intention behavior factors in pregnant women that influence the decision to carry out the tradition can be seen in figure below.



**Figure 3** Scheme of Behavior Intention Factor in Pregnant Mother Associated With Se'i Tradition

a. Knowledge about Se'i Tradition

According Daulay [2], almost all over the world, individuals and communities have the knowledge handed down from generation to generation. Traditional knowledge can be found in various fields of life that are relevant to the traditional society, especially related to the fulfillment of basic needs such as medicine, food, and agriculture.

Based on interviews with pregnant mother, is not all pregnant mothers know the implementation of se'i tradition. As a mother following statement, when asked "do you ever told about se'i tradition was? Do your Mother-in-law also ever tell about it? Do your husband also ever tell about it?". Pregnant women replied, "Not yet" (Pregnant Mother SHN, 24 years). Some pregnant mothers have their knowledge about se'i tradition. Even has done se'i tradition at previous childrenbirth. The following are excerpts of quotes.

"I know. I did se'i for my first and second child." (Pregnant Mother AT, 32 years)

"I know, after mother giving birth." (Pregnant Mother RL, 36 years)

b. The Importance of Se'i Tradition

The importance of se'i tradition will affect its implementation. If the mother judge se'i tradition is important, then it will encourage mothers to do se'i tradition. For some pregnant mothers in the District of South Amanuban, se'i tradition is important. As a statement pregnant mothers in the following interview.

"It is important did se'i tradition. I did Se'i tradition first child as well. The second child also." (Pregnant Mother AT, 32 years)

"It is important, I did on my first until third children, so i have better body." (Pregnant Mother RL, 36 years)

"It should be, so that will become healthy mothers." (Pregnant Mother T, 17 years)



**Figure 4** The Interview Process with Pregnant Mother

c. The Intention of Doing Se'i Tradition During The Postpartum Period

Intention may become beginning of a person in doing or is not doing something. Fishbein and Ajzen (1980) in Notoatmodjo [6] emphasized the importance of the role of intention as an excuse or a determinant factor of behavior. Then, the intention is determined by:

- 1) Attitude, that is a comprehensive assessment of the behavior or action will be taken.
- 2) subjective norms, namely belief in the opinion of others, about approving or not approving the action will be taken.
- 3) Control of behavior, that is the perception of the consequences of that behavior will be done.

Results of interviews with pregnant mothers showed that the majority of pregnant mother who are subjects of research stated that would do se'i tradition that has been adapted to the advice of medical personnel. But there is also the intention of not doing se'i tradition during postpartum. There are the quotes of interview.

*"Yes, I will do se'i tradition and Tatobi also."* (Pregnant Mother AT, 32 years)

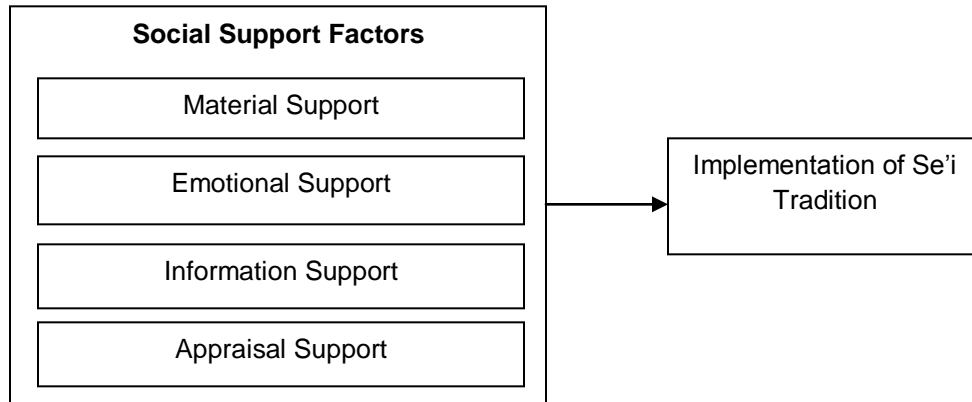
*"No, I will not do se'i tradition, I will give birth at a health center."* (Pregnant Mother RL, 36 years)

**Analysis of Social Support Factor in Pregnant Mother Associated With Se'i Tradition**

Social support factors in pregnant women is related to se'i tradition of social support from the community around pregnant mothers to do se'i tradition. This form of social support includes material support, emotional support, information support and appraisal support.

Social support factors in pregnant women that influence the decision to carry out the tradition can be seen in the picture below.





**Figure 5** Scheme of Social Support Factor in Pregnant Mother Associated With Se'i Tradition

a. Material Support

Material support is one of the enabling factors that support the implementation of se'i tradition. In this study showed that there is a family of pregnant mothers that provide the material needs such as equipment required to implement se'i tradition. Traditional healer just preparing wood, cloth, water, and rice. The following are excerpts of quotes.

*"There is support from family, that carry water, bring borse, some carry wood."*

(Pregnant Mother AT, 32 years)

*"Mama is provide all the material because I turning back to my own house."*

(Pregnant Mother T, 17 years)

Based on interviews with a husband, obtained an explanation that is necessary to perform se'i tradition with red wood and the wood is hard to find. To prepare the wood it will take a month before delivery. In addition to wood, it also required water, lighters, charcoal, and doles. As well as the research conducted of Handayani [4], the results obtained since the husband know that his wife was pregnant, then her husband will find wood for the preparation of the se'i tradition.

b. Emotional Support

According to the WHO in Notoatmodjo [6], a person's behavior is more influenced by people that are considered important. FGD stated that members of the family that considered to be most instrumental in pushing to briefly se'i tradition can be seen in the table below.

**Table 1** People who Encourage to do Se'i Tradition

No	Data Findings	Quotes
1.	Mother-in-Law	<i>"Mamak mantu sendiri."</i> (Ibu Hamil AT, 32 tahun) <i>"Parents. Most of them want to take care their grandchild, son-in-law, so basically we have to follow their wishes. If you want to confronted sometimes they did not dare to want to fight."</i> (Cadre E, 27 years)
2.	Parents	<i>"Mama told me to do the se'i tradition."</i> (Pregnant Mother T, 17 years) <i>"Mama told me to use live coals."</i> (Pregnant Mother EL, 29 years)
3.	Mother	

Source : Primary data research

Research conducted by Handayani [4] revealed that the husband is very supportive and encourages mothers to do se'i tradition during the postpartum in order to recover maternal health soon, get strong quickly, and will not get pregnant again in short period.

c. Information Support

According to Thohir [11], information is related to the description, explanation, clarification, and evaluation of a case. Related informations about the implementation of se'i tradition that pregnant mothers obtained is generally from the family, following the quotes footage :

*"... From my sister-in-law who give birth at home with assistance from old mama."* (Pregnant Mother T, 17 years)

Besides the family, information was also obtained from the Traditional healer. In Handayani research [4], the results showed that mothers that implement the tradition of se'i only obtain information about the advantages of doing se'i tradition from the parents and Traditional healer who cared for them. Parents and Traditional healer believed to be the party both in terms of closeness and ability to care for, though without scientific explanation.

d. Appraisal Support

There are various parties that advise pregnant mothers that do the se'i tradition can bring good for health. The following are excerpts quotes:

*"There is, from the mama-in-law."* (Pregnant Mother AT, 32 years)

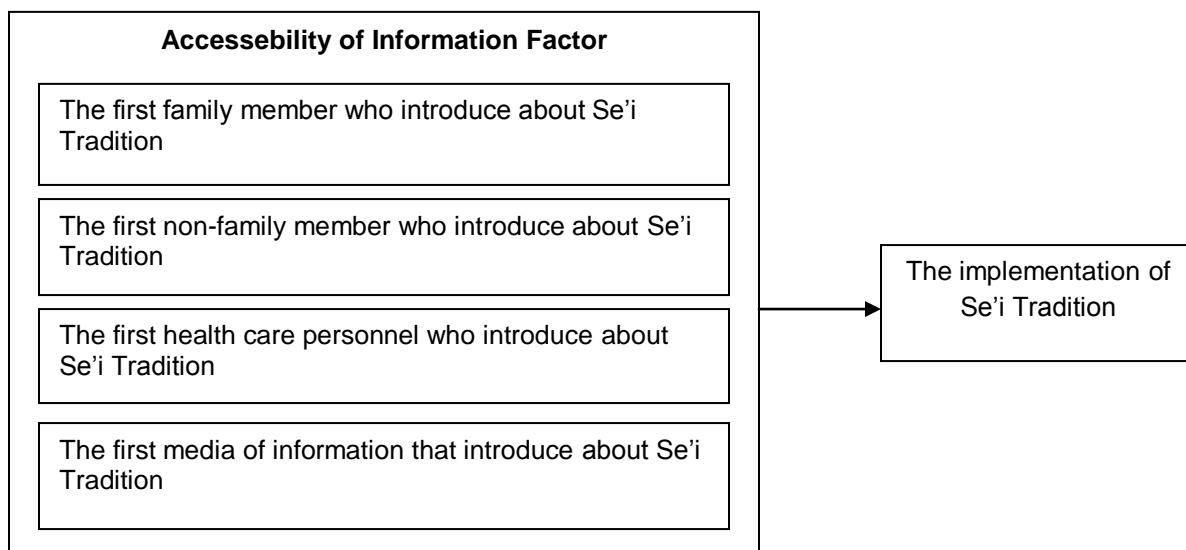
*"The in-laws and husband."* (Pregnant Mother T, 17 years)

*"Many people, in Oebelo."* (Pregnant Mother DS, 20 years)

The support from the the family is also become a driving factor in the implementation of se'i tradition. Required the support from the community-based on health. According to Adisasmito [1], there are several forms of society's role in the development of national health and development.

**Analysis of Accesability of Information Factor in Pregnant Mother Associated With Se'i Tradition**

Information is needed to improve the knowledge. According to Bloom in Notoatmodjo [7], knowledge is become one of behavior domains. Accesability of information factor on pregnant women related to se'i tradition is the presence of information that causes the mother know about the implementation of se'i tradition. Accesability of information factor on pregnant women influence their decision to carry out the tradition, that could be seen in the picture below.



**Figure 6** Scheme of Accesability of Information Factor in Pregnant Mother Associated With Se'i Tradition



**Table 2** Result of the Interview about Accesability of Information Factor in Pregnant Mother Associated With Se'i Tradition

No	Items	Findings	Quotes
1.	The first family member who introduce about Se'i Tradition	For most pregnant mothers, family members who first introduced the se'i tradition is the mother-in-law. A pregnant woman stated that family members who first introduced the se'i tradition is his biological mother.  According to a husband, the first person who informed him that his wife should do se'i tradition are the ancestor.	<i>"My mother."</i> (Pregnant Mother SHN, 24 years)  <i>"Mama, she gave birth to us in the kitchen. Fire at the bedside should be lit continuously for 40 days. When the fire dies, the mother and baby will be cold. Mother and baby should not get the wind, so they do not get fever."</i> (Pregnant Mother LF, 28 years)  <i>"That is the story from my ancestor."</i> (N, 35 years)
2.	The first non-family member who introduce about Se'i Tradition	People outside the family members who first introduced the se'i tradition to pregnant women are neighbors and Traditional healer.	
3.	The first health care personnel who introduce about Se'i Tradition	Doctors and midwives tell the dangers of doing se'i tradition	<i>"The midwife, while Posyandu they give education about it."</i> (Pregnant Mother AT, 32 years)
4.	Media of Information that can be accessed by Pregnant Mother relate to Se'i Tradition	No media of information found that can be accessed by women related to the se'i tradition.	

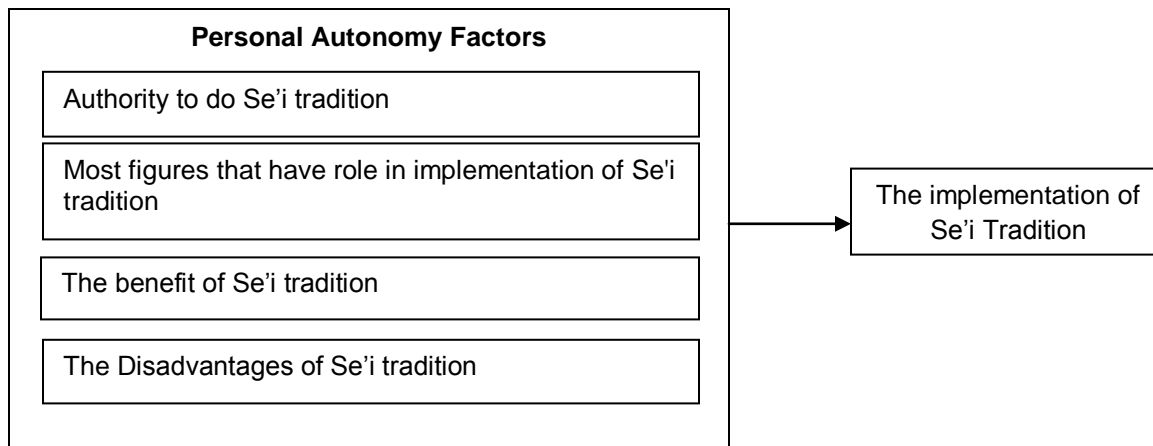
Source : Primary data research

From the interviews, it was found that the access to information from outside the family and family members who introduce se'i are support the mothers to do se'i. While information from health workers which contain an explanation about the dangers of se'i that does not support the mother to do se'i. According to Adisasmito [1], health volunteers have a role in conveying information or knowledge and skills to the community. Because it comes from the local community, cadres can be closer to the community, so that if the transfer of knowledge and skills can be channeled more easily between cadres and the neighbors. The closeness of the officer cadre of health centers have made a bridge between health workers and the community.

No media of information found that can be accessed by women related to the se'i tradition. That means all the information which supportive to do the se'i traditon are only obtained from family, neighbors, and Traditional Healer.

### **Analysis of Personal Autonomy Factor in Pregnant Mother Associated With Se'i Tradition**

Personal autonomy factors in pregnant women associated with se'i tradition are the parties who concerned to take action or decisions regarding whether or not to do se'i after delivery. Personal factors autonomy of pregnant women which influence the decision to carry out the tradition can be seen in the picture below.



**Figure 7** Scheme of Personal Autonomy Factor in Pregnant Mother Associated With Se'i Tradition

a. The Authority to do Se'i Tradition

The authority to do se'i traditions during postpartum period is varies. Most of the study subjects stated that the authority found on the mother or mother-in-law. This is supported by the statement of the head of the village, that the authorities usually are parents or in-laws. Here are excerpts of quotes.

*"It usually her parents. Usually the biological parents or could also the in-law."*  
(Village Head of Pollo)

While Native Elders revealed that the husband should contribute to make decisions to do se'i tradition.

*"Myself and a midwife from the health center has been given an explanation about everything because we must follow the rules."* (MO, 85 years)

b. Most figures that have role in implementation of Se'i tradition

A cadre stated that parents give a big role in doing se'i tradition. Here are excerpts of quotes.

*"Parents. Most of them want to take care their grandchild and son-in-law, so basically have to followed their wishes . If you want to be confronted sometimes they did not dare to want to fight. Actually, they want to get rid of it but they do not want to fight their parents or in-law. That will make a trouble."* (Cadre, E)

*"If the person most responsible for it should be the closest obviously mother-in-law, father-in-law and birth mother. Most of these cadres are just talking, but the closest parties are in the house, who set all for the mother because the mother was sleeping in the bed, so she can only surrender for this."* (Cadre, C)

According to cadre AL (29 years old) mother-in-law formerly actually told to do se'i. If the husband then also encourages to do se'i is because the husband remember the message of his parents.

*"Yes, remember from parents."* (Kader AL, 29 years)

A husband revealed that he would not let his wife do se'i although such mother-in-law told his wife to do se'i.

*"That did not happen, right now today. Has changed not like it used to."* (M, 35 years).

A pregnant mother feels that the figures who involved in do or not do the se'i tradition is herself.

*"I am alone."* (Pregnant Mother AT, 32 years)

In Handayani research [4], found that the results there are fears in the postpartum mother if not follow the restrictions and suggestions given by parents, relatives, and neighbors. This is caused if there is a disruption to the baby, the baby's mother was blamed for not being careful in taking care of her pregnancy. Handayani [4] mentions that the determination of decisions during pregnancy until postpartum, such as selecting a pregnancy examination, choosing a birth place, choosing a place to stay after birth, usually dominated by the husband. But in this study generates information that the birth mother and mother-in-law who plays a role in taking the decision.

c. The benefit of Se'i tradition

Se'i tradition is still being done because it is considered to have the benefit or advantage. Most of the research subjects and informants thought that do se'i can make their body healthy and strong. Here are excerpts of quotes.

*"Healthy. Yes, strong."* (Pregnant Mother AT, 32 years)

*"I do not know, I took it, it means adherents, get strong quickly."* (Pregnant Mother N, 35 years)

*"So the body can be strong."* (Pregnant Mother Y, 20 years)

d. The Disadvantages of Se'i tradition

The loss experienced by the mother for doing se'i are mothers become unproductive in their activities. This was stated by pregnant women in the following interview.

*"The losses I can not work anything below, just above it, sit quietly. I eat and drink by myself. After four days and nights I can come down."* (Maternity AT, 32 years)

Besides the mother becomes unproductive, wound healing after childbirth became more difficult and can occur respiratory problems in infants. Here are excerpts of quotes.

*"In our opinion she will getting worse. If the injuries are not severe, they will not come."* (Cadre E)

*"The infants have certainly cold, respiratory infection or pneumonia. Because the baby and mother slept together."* (Cadre A)

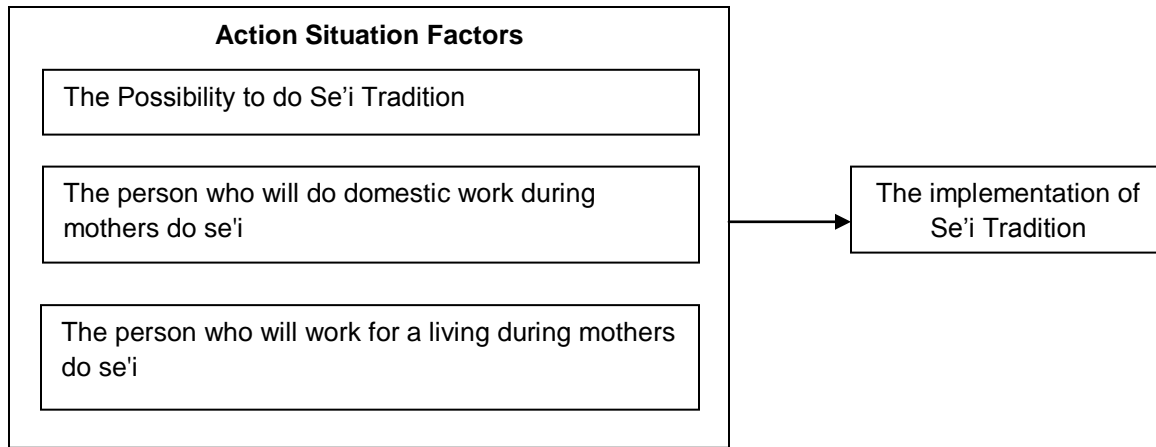
*"The smoke is not good for young children."* (Pregnant Mother MN, 29 years)

*"Mother was until decubitus, until the wound occur because roast it there."* (Midwife B, 48 years)

The phenomenon of the advantages and disadvantages can simultaneously making people think to consider whether to do or not do the se'i tradition. The disadvantage in terms of health may not be delivered to the mother is indeed the condition of the mother is not sick or otherwise.

### **Analysis of Action Situation Factor in Pregnant Mother Associated With Se'i Tradition**

Action situation factors that related to se'i traditions among pregnant mother are situations that allow to act or not to do se'i. These factors include the ability to do se'i for 40 days, the person who will do domestic work during mothers do se'i, and the person who will work for a living during mothers do se'i. Factors action situation in pregnant women that influence the decision to do the tradition can be seen in the picture below.



**Figure 8** Scheme of Action Situation Factor in Pregnant Mother Associated With Se'i Tradition

**Table 3** Result of Interview about Action Situation Factor in Pregnant Mother Associated With Se'i Tradition

No	Items	Findings	Quotes
1.	The Possibility to do Se'i Tradition	There are pregnant women who believe that se'i allow to be done for 40 days and there are who are not sure.	<p><i>"Yes, it should be 40 days and 40 nights."</i> (Pregnant Mother AT, 32 years)</p> <p><i>"The possibility only 2-3 weeks"</i> (Pregnant Mother LF, 28 years)</p> <p><i>"It is impossible Se'i, because the rules are not allowed. If allowed, definitely do Se'i."</i> (Pregnant Mother T, 17 years)</p>
2.	The person who will do domestic work during mothers do se'i	<p>When mothers do se'i, she can not do domestic work. It would require another person who helped to complete the housework.</p> <p>a. Family b. Mother c. Mother-In-Law d. Husband e. Child</p>	<p><i>"Mamak Dompu came, the family all came. Mamak, mamak in-law."</i> (Pregnant Mother AT, 32 years)</p> <p><i>"The husband and children."</i> (Pregnant Mother VB, 39 years)</p>
3.	The person who will work for a living during mothers do se'i	During pregnancy and do se'i, who will work is the husband.	<p><i>"My own husband."</i> (Pregnant Mother AT, 32 years)</p> <p><i>"Husband, mother help rice planting."</i> (Pregnant Mother LF, 28 years)</p> <p><i>"Father is corn and rice farmers and porters."</i> (Pregnant Mother VB, 39 years)</p>

Source : Primary Data Research

Based on the results obtained are several factors that contribute to se'i. Among these is the belief in themselves to do se'i for 40 days, there are others who help with domestic work while the mother se'i, and there are others who work while the mother se'i. This condition makes the mother has the time to focus more on se'i implementation because there are people who replaces doing domestic jobs and there are who stand for the work.

The government regulation has made a mother are not have the confidence to do se'i, but it will are not do merely because it is prohibited. Not because of understanding, because the mother said that if are not prohibited, then she will keep do the se'i.

The results showed that people in the village Pollo and Bena, District of South Amanuban, do the se'i tradition because, 1.) intention behavior factors: accelerate the recovery of post-birth mother in order to get stronger quickly, can eliminate the dirty blood clots in order not to become fetal back, and avoid white blood rose to the head, 2.) social support factors include the availability of support, especially from the family to do se'i, 3.) accessebility of information factors, which is the family (mother and mother-in-law) who were first introduced the se'i tradition, 4.) personal autonomy factors, includes the authority to implement se'i tradition on the birth mother or mother-in-law, 5.) action situation factor, include the possibility of mother implement se'i for 40 days, this activity is strongly supported because there are people who replaces the mother doing domestic work and only the husband works for a living during the mothers do se'i, so she can focus on implement this tradition.

## **Conclusion**

1. The Pregnant women have a tendency to do se'i tradition to accelerate the recovery of postpartum to become immediately powerful, can eliminate the dirty blood clots from becoming fetal back and avoid white blood rose to the head so as not to be mad.
2. Behavioral intention factors include their knowledge about se'i traditions, beliefs that se'i important to do, and their intentions to do se'i.
3. Social support factors include the availability of support, especially from the family to do se'i.
4. Accessebility of information factor, which there are outside the family and the family members who first introduced about se'i tradition.
5. Personal autonomy factors include the authority to implement the se'i tradition there are at the birth mother or mother-in-law.
6. Action situation factors include enable to implement se'i for 40 days, provide a replacement for mother doing domestic work during implement the se'i tradition and there are people who work for a living during mothers do se'i, so she can focus on implementing this tradition.

## **Recomendation**

1. Implementation of health education for pregnant women about afterpostpartum care routine will give an understanding about the implementation se'i tradition which matches the value of health.
2. The birth mother or mother-in-law of pregnant women should also be involved in the health education.
3. The involvement of religious leaders as a mediator between the community and health workers in implementing relevant policies se'i tradition, is needed.

## **Acknowledgements**

The authors would like to acknowledge Direktorat Jenderal Pendidikan Tinggi Indonesia (DIKTI) for funding this study. We thank all the community leaders,health volunteers, traditional healers, cadres, pregnant mothers and her family in Pollo and Bena, District of South Amanuban, NTT for their enthusiastic participation in this study.

## **Reference**

- 1) Adisasmito, W. 2010. Sistem Kesehatan. Jakarta : PT. RajaGrafindo Persada.
- 2) Daulay, Zainul. 2011. Pengetahuan Tradisional : Konsep, Dasar Hukum, dan Praktiknya. Jakarta : Rajawali Pers.
- 3) Djaja, S. dan T. Afifah. 2011. Pencapaian dan Tantangan Status Kesehatan Maternal di Indonesia. Jurnal Ekologi Kesehatan Vol. 10 No. 1 Maret 2011.

- 4) Handayani, Kartika. 2012. Tradisi Se'i: studi tentang perawatan ibu pasca melahirkan di kota Amanuban Barat kab. Timor Tengah Selatan. *Tesis*. Progam Studi Pascasarjana Antropologi, Universitas Indonesia, Depok.
- 5) Musadad, A., Rachmalina, E. Rahajeng. 2003. Pengambilan Keputusan dalam Pertolongan Persalinan di Provinsi Nusa Tenggara Timur. *Jurnal Ekologi Kesehatan* Vol. 2 No. 1, April 2003 : 200-208.
- 6) Notoatmodjo, Soekidjo. 2010. *Ilmu Perilaku Kesehatan*. Jakarta : Rineka Cipta.
- 7) Notoatmodjo, Soekidjo. 1993. *Pengantar Pendidikan Kesehatan dan Ilmu Perilaku Kesehatan*. Yogyakarta : Andi Offset.
- 8) Rahayu, S. K., N. Toyamah, S.A. Hutagalung, M. Rosfadhila, M. Syukri. 2008. *Studi Baseline Kualitatif PNPM Generasi dan PKH : Ketersediaan dan Penggunaan Pelayanan Kesehatan Ibu dan Anak dan Pendidikan Dasar di Provinsi Jawa Barat dan Provinsi Nusa Tenggara Timur*. Jakarta : Lembaga Penelitian SMERU.
- 9) Ranjabar, J. 2006. *Sistem Sosial Budaya Indonesia (Suatu Pengantar)*. Bogor : Ghalia Indonesia.
- 10) Soerahman, R. dan Y. Wiryana. 2011. *Studi Intervensi Tradisi SE'I di Kabupaten Timor Tengah Selatan Tahap 2 : (PARTICIPATORY ACTION RESEARCH)*. Jakarta : Pusat Teknologi Intervensi Kesehatan Masyarakat.
- 11) Thohir, Mudjahirin. 2007. *Memahami Kebudayaan (Teori, Metodologi, dan Aplikasi)*. Semarang : Fasindo.
- 12) WHO. 2005. *MDG: Millenium Development Goals*. Geneva: WHO.

# THE ESTABLISHMENT OF CHILD HEALTH CADRE AS PREVENTION FOR FOODBORNE DISEASE AT PRIMARY SCHOOLS

<sup>1</sup>Fariani Syahrul and <sup>2</sup>Arief Hargono

<sup>1</sup>Dept.of Epidemiology, Faculty of Public Health, Airlangga University,  
email :[fariani\\_syahrul@yahoo.com](mailto:fariani_syahrul@yahoo.com), +62-08123519746.

<sup>2</sup>Dept.of Epidemiology, Faculty of Public Health, Airlangga University,  
email :[arief.hargono@gmail.com](mailto:arief.hargono@gmail.com), +62-08165437780.

## Abstract

*Quality of human resources is determined by two factors which are interconnected and interdependent, namely education factor and health factor. Personal health, including health on school-age children comes from food intake. But often, these foods can cause health problems, such as foodborne diseases or foodborne illness. There are several factors that can reduce the occurrence of suspected foodborne diseases such as hand-washing habit, habit of eating snacks at school, habit of bringing lunch, and others. The objective of this research is to monitor the Clean and Healthy Lifestyle (CHL) of children at school through the establishment and evaluation of child health cadres.*

*The type of research is quasi-experimental. Intervention is conducted in form of the establishment of child health cadres at Kalijudan II Elementary School in Surabaya. The location was chosen based on the results of previous studies. Phases of activities including the selection of child health cadres (10 children), training and determination of the child that will be monitored (40 children), preliminary assessment on the monitored CHL child, two-month monitoring, and final assessment. Monitored CHL are the CHL associated with foodborne diseases such as clean nails, school snacks habit, habit of bringing lunch, and hand-washing habit in schools. Cadres are equipped with books as a tool for monitoring. Each cadre will monitor 4 children with a frequency of 2 times per week for the duration of 2 months. To assess the results of pre- and post-test monitoring, Chi-Square Test analysis is used. In addition, there are evaluations on the work of child health cadres including routine monitoring and data completeness in the books.*

*Descriptive analysis showed that there were differences between the CHL school children before and after the monitoring conducted by child health cadres, however the results of the Chi-Square Test indicated that only the habit of bringing lunch that yield a significant change ( $p=0.01$ ). This condition occurs because the monitoring is only carried out for 2 months. Evaluation of the routine activity showed that the average cadre activity on monitoring is 75.7% (range 29% - 100%) and the average of completeness monitoring books is 91.9% (range 80%-100%). The activities of child health cadres can be applied on an ongoing basis with the school health program activities that have been established in schools.*

*Keywords : child health cadre, foodborne diseases, prevention*

## Introduction

School children are the next generation and the strategic assets for development, thus they are expected to be healthy, intelligent and productive. The quality of children as the next generation is determined by two factors which are interrelated and interdependent, namely education and health. For this reason, it is important to protect children from the risks of health problems. Elementary School Age (approximately 6-12 years old) is the time when children are fond of playing and eating snacks (including street food outside the school complex), therefore they are at risk for various health problems.

One of the factors determining one's health, including those of school children, is the food intake. But often, these foods people consumed may pose a health problem instead. Consumption of snacks containing chemical or biological contamination is very dangerous for children's health and safety. This behavior can lead to contraction of foodborne diseases.

Foodborne diseases (FBDs) is any disease resulting from the consumption of contaminated food and/or drink, caused by various microorganisms or microbial pathogens that contaminate food or drink. FBDs caused by microbes occur through water contamination, cutlery/drinking utilities, hand and intermediary vectors such as flies and cockroaches. Types of FBDs include food poisoning, diarrhea, dysentery, typhoid, cholera, and others (Rozendaal, JA, 1997; Torgerson, et.al, 2014).

In developed countries, it is estimated that the rate of foodborne diseases may be 10-350 times higher than the reported cases (Borgdorff, 2005). Various studies have found that the type of agent on FBDs incident is enteric, parasitic, and chemical (Haagsma, JA, et.al, 2013). One type of most common FBDs are diarrhea. The results showed that episodes of diarrhea per year in children is quite high at 3.2 to 4.6 episodes, with 70% of which are caused by contaminated food (Mensah, 2002).

The results of Basic Health Research in 2007 showed that the prevalence rate of diarrhea in Indonesia is around 42.2%. In school-age children (5-14 years), the numbers of diarrhea ranks the 5th highest after the age groups of infant, toddler and the elderly, amounting to 9.0%. Typhoid in the group of school-age children occupies the highest prevalence compared to all other age groups, amounting to 1.9%. Research results from BPOM (Agency for Food and Drug Administration) in 2007 in Surabaya showed that within 700 students from primary schools in the subdistrict Genteng, 60% of them still consumed street food from outside the school. Ironically, the majority of snacks from street food are unhealthy snacks. The research of five elementary schools in the region of East Surabaya showed that 59.7% of students always buy snacks in schools; 36.1% sometimes buy snacks at school and only 4.2% of students never buy snacks at school (Syahrul, F, 2011).

Occurrence of FBDs, such as diarrhea and typhoid in school children, were still sufficient susceptible. Lack of clean and healthy behavior became the primary cause, so that the contaminated agent can easily enter to the body through the food consumed (Sholikhah, et.al, 2013). Some factors that allegedly can reduce the occurrence of foodborne diseases are hand-washing habits, customs school snacks, bringing snacks/lunch to school, and others. Snacks are food and drink produced by the informal sector entrepreneurs with small assets. These snacks are ready to be consumed and sold in public places, in the street and in the housing area by mobile street hawker, or in street stalls, or combination of both methods. In this case, snacks can be main meal or food interlude.

Based on the background and the study of the problem, this research on the Clean and Healthy Lifestyle (CHL) of children at school was conducted by doing intervention in form of monitoring by children health cadre. The objective of this research is to monitor the Clean and Healthy Lifestyle (CHL) of children at schools through the establishment and evaluation of children health cadres.

## **Methods and Materials**

The type of research is a quasi-experimental. The research sample consisted of 40 students of 4<sup>th</sup> and 5<sup>th</sup> grade in Kalijudan II Elementary School Surabaya. The location was chosen based on the results of previous studies (Syahrul, F, 2011). Intervention was done by establishing children health cadres. For this purpose, 10 children were asked to monitor the Clean and Healthy Lifestyle (CHL) of students at school, where each of children health cadre will monitor 4 children.

There were 6 stages of activities: (1) the selection of children health cadre (10 children) by providing questionnaires to all students in grade 4 and grade 5 to assess their levels of knowledge about the Clean and Healthy Lifestyle (CHL); (2) the training of selected children health cadre; (3) determining the children that will be monitored (40 children); (4) preliminary assessment of CHL (nail hygiene and handwashing, the habit of bringing lunch and having snack at school); (5)



implementation of monitoring by children health cadre duration of 2 months, and (6) the final assessment of CHL in children being monitored.

The children health cadre are equipped with monitoring books as a tool for conducting monitoring. Each cadre will monitor 4 children with frequency of 2 times per week for the duration of 2 months.

The data were analyzed descriptively to describe the study variables, meanwhile to assess the results of pre- and post-test monitoring different proportion test was held (Chi-square test with  $\alpha = 0.05$ ). In addition, an evaluation on the performance of children health cadre includes monitoring and completing monitoring books.

## Results

### Characteristics of student

The average age of the student was 10.04 years old (range between 9-13 years old). Most of the student were girls (54.6%) and 45.4% were boys. Most students were given pocket money by their parents (79.8%), while the rest 20.2% of students were only occasionally given pocket money. This means that every student might bring money to school at least once. The average money brought by the students was Rp 3,558.82 (range between Rp 1,000.00 - Rp 10,000.00).

### Description of student's CHL

The student's CHL being monitored were nail conditions (trimmed, long, clean or dirty), hand washing habits, habits of bringing lunch and buying snacks at school. Children health cadre monitored CHL twice a week for 2 months, so there were 8 times of observation. Conditions pre- and post-monitoring were used in analysis toward the differences in CHL.

The results showed that there was a rise in the percentage of children whose nails were clean and trimmed during post-monitoring, meanwhile the percentage of children with long and unkempt fingernails fell during post monitoring. However, the results of the Chi-Square test have significance value of  $>0.05$  ( $p=0.135$  for trimmed/long nails and  $p=0.316$  for clean/dirty nails), so there is no significant difference in the condition of student nails between pre- and post-monitoring by children health cadre.

Table 1. Description of the student nail condition based on pre- and post-monitoring by children health cadre.

Nail condition	Pre-monitoring		Post-monitoring	
	n	%	n	%
Clean	31	77.5	33	82.5
Dirty	9	22.5	7	17.5
N	40	100.0	40	100.0
Trimmed	25	62.5	30	75.0
Long	15	37.5	10	25.0
N	40	100.0	40	100.0

The habit of handwashing with soap in schools is already good. It is shown by an increase during post-monitoring, and as a contrary, the percentage of children who wash their hands without soap decreases. However there is a bad sign in the rise of the percentage of students who do not wash their hands during post-monitoring. This condition yields results of the Chi-Square test with significant value of  $>0.05$  ( $p=1,000$ ). The complete results can be seen in Table 2.

Table2. Description of handwashing habit at school based on pre- and post-monitoring by children health cadre

Handwashing habit at school	Pre-monitoring		Post-monitoring	
	n	%	n	%
Hand washing with soap	1	2.5	4	10.0
Hand washing without soap	25	62.5	12	30.0
Did not wash hands	14	35.0	24	60.0
N	40	100.0	40	100.0

The results of a descriptive study showed the differences in the habit of carrying lunch between pre- and post-monitoring. The percentage of children who bring lunch rises during post-monitoring. In contrary, the number of students who were not used to bring lunch decreased during post-monitoring. Chi-square test result showed that there were differences in the habit of bringing lunch ( $p = 0.010$ ) between the pre- and post-monitoring.

The next result showed that the majority of students have a habit of consuming snacks at school, both in the school cafeteria and snack stalls outside the school area (street food) either during pre- or post-monitoring. There is no significant difference between pre- and post-monitoring for this subject ( $p = 0.507$ ). The complete results can be seen in Table 3.

Table3. Description of the habit of bringing lunch and buying snacks (snacking) at school on pre- and post-monitoring by children health cadre

Eating habit at school	Pre-monitoring		Post-monitoring	
	n	%	n	%
Have a habit of bringing lunch/snack from home				
Yes	15	37.5	24	60.0
No	25	62.5	16	40.0
N	40	100.0	40	100.0
Buying snacks (snacking) at school				
Yes :				
Buying snacks at school cafeteria	0	0	1	2.5
Buying snacks at school cafeteria and street stalls	4	10.0	0	0
Buying snacks at street stalls	31	77.5	34	85.0
No	5	12.5	5	12.5
N	40	100.0	40	100.0

### The evaluation of children health cadre

The evaluation conducted consists of Process Evaluation and Result Evaluation on the implementation of monitoring activities carried out by children health cadre for 8 weeks upon their classmates.

#### Process Evaluation

The process evaluation includes the implementation of monitoring activities and the signing of monitoring books by class teachers every Saturday.

The results of the process evaluation are as follows:

- 1) All cadres say that there is no difficulty in carrying out the monitoring and filling out the monitoring books.
- 2) One child health cadre (10%) could not continue the monitoring activities at the 6th week because of illness. The monitoring was postponed and continued after the cadre went back to school.
- 3) All the monitoring books have been signed by class teachers every Saturday.

#### Result Evaluation

After the completion of monitoring activities, an evaluation of the work of children health cadre was conducted, especially on the monitoring routine and completion of the monitoring books.

The results:

Table 4. Result Evaluation on the Performance of Children Health Cadre

Grade	Children Health Cadre	Routine	Completion
IV	A	71 %	100 %
	B	71 %	100 %
	C	100 %	80 %
	D	29 %	80 %
V	E	100 %	89 %
	F	100 %	96 %
	G	93 %	96 %
	H	93 %	100 %
	I	29 %	94 %
	J	71 %	84 %
Average		75.7 %	91.9 %

Result evaluation on the routines showed that the average of cadre members routinely monitoring that target's CHL was 75.7% (range between 29% -100%), while the average completion of monitoring books by cadres was 91.9% (range between 80% -100%).

## Discussion

### Students' CHL

Students' CHL monitored in this study is CHL at school related to preventive measures against foodborne diseases. Therefore, the variable which was monitored is the condition of nails, hand washing habits at school, the habit of bringing lunch, and the habit of buying snacks at school.

**Nail conditions.** Monitoring results showed high percentage of school children who have long and dirty fingernails and there was no significant difference of nail conditions between pre-and post-monitoring. This is unfortunate because fingernails are very likely to be a medium for the transmission of foodborne diseases. During the monitoring, the children health cadre observed the condition of their classmates' nails. The results of previous studies showed that there was a relationship between the number of microbes (*E. coli*) with the length of fingernails; with higher number of microbes are found under long fingernails.

**Handwashing habit.** The research showed that only about 10% of students have the habit of washing their hands with soap at school. The result of interviews with children who do not have hand washing habit revealed that they do not wash their hands because they are busy playing with their friends and there is no adult supervision. This suggested that the children health cadre has no influence on changing the hand washing habit on student. This bad habit is very prone to the risk of being infected by foodborne diseases. The result of previous studies showed that the risk of foodborne diseases (diarrhea and typhoid) in children who do not wash hands before eating is 4.43 times greater than children who have hand washing habit (Syahrul, F, 2011). Food/beverage is very easily contaminated with microbes from unclean hands, which can cause health problems if the food/beverage is consumed.

**The habit of bringing lunch.** The research showed significant difference between pre-and post-monitoring ( $p < 0.05$ ) on students who have the habit of bringing lunch/snack from home. It is a good habit because this way the food/beverage consumed are generally cleaner and more secure from the danger of microbial contamination. In fact, most of the students who bring their own lunch still have a habit of buying snacks at school, due to their long study hour at school (about 6 hours). Thus, students need more food intake while at school. On the other hand, the monitoring conducted by the children health cadre has indeed influenced the habit of bring lunch to school in some student who was monitored. By bringing lunch to school, students' food safety is more assured rather than buying snack outside school.

The habit of buying snacks (snacking) at school. The research showed that there was no significant difference between pre- and post-monitoring of the habit of buying snacks at school. Eating snacks is very popular among students. The habit of buying snacks at school is very difficult to change. There are many factors that shaped this habit, such as the need for food intake during the long school hours and also the fact that children love rich taste of food like sweet, savory and sour. For these reasons, it was easy for street food sellers to attract children to buy snacks from them. Therefore, it is very difficult to change student habit for buying snack outside the school area, even after they have been monitored. The problem is that the products offered by the street food sellers are often lack in nutrients or contain ingredients that are harmful or prone to microbial contamination

The results of research in different countries and different times showed that street food is a source of microbial infection. Research by taking samples of salami (a type of dry sausage) and hamburgers on laboratory tests indicated that the food had become a transmission source of *E. coli* O157: H7 (Cieslak, et al, 1997). Other studies with fast foods samples, also found that there were some microbes in food, such as *Salmonella* sp, *E. coli*, *S. aureus*, *B.cereus* and *P.aeruginosa* (Nunes, et.al, 2013). Similarly with researches conducted in Indonesia, confirming the presence of *Escherichia coli* bacteria contamination in food and beverage samples taken in Primary Schools (Puspitasari, 2013). Food becomes less secure, mostly because of biological agents such as *Salmonella*, *Compylobacter*, and *Escherichia coli*. There are many other agents that make food unsafe (Cary, et.al, 2000).

Snacks safe for consumption should not contain dangerous hazard comprising of biological/microbiological, chemical and physical contamination that can harm and endanger human health (Ministry of Health, Republic of Indonesia, 2012). Due to the increasing need for snacks and food intake at school, there should be a school canteen with direct supervision from the teachers.

## Evaluation on the performance of children health cadre

Evaluation on the performance of children health cadre was conducted after they monitored their classmate for 2 months. On average, cadre monitoring routine is 75.7% (range 29% - 100%). This showed good results because it has more than 75%. Meanwhile, the average completion of monitoring books is 91.9% (range 80% - 100%). This completion includes their classroom teachers signature given on every weekend.

The monitoring performed by children health cadre did not strongly affect on improving CHL at school, except on the variable of bringing lunch from home. It may be necessary to conduct further research with a longer monitoring time so that visible improvement relating to CHL on students can be seen. Behavior change requires a relatively long time and must be supported by the environment and the availability of infrastructure, for example the availability of adequate school canteen, the availability of hand-washing facilities near the children playground as well as providing food health guidance for street food vendors around the school. This way, the children health cadre as health promotion ambassador can perform their roles optimally. The results of a study aimed to assess the relationship between teenagers' consuming behaviour on food around the school recommends that school programs aimed for the promotion of healthy foods should be the target for improving a healthy school environment (Kubik, MY, et.al, 2003).

## Conclusions

1. The analysis result on the differences of student CHL between pre- and post-monitoring conducted by children health cadre showed only changes in one variable of bringing lunch from home.
2. Evaluation on the children health cadre concluded that their performance was quite successful, with percentage of routine activities and completion of monitoring was above 75%. However, the monitoring by children health cadre had not been able to significantly change the students' CHL, except the habit of bringing lunch. Monitoring activities by the children health cadre can be applied on an ongoing basis, along with the school health program that have been established at schools.

## References

- Borgdorff, MW dan Yasmine, M, (2005). *Isu Keamanan Pangan. Surveilans Penyakit Bawaan Makanan: Sistem Apa Saja yang Dapat Digunakan ?* WHO-ICD/SEAMEO Tropmed RCCN, Universitas Indonesia.
- Cary JW, et.al (2000). *Microbial Foodborne Diseases – Mechanism of Pathogenesis and Toxin Synthesis*. Technomic Publishing Company Inc. USA.
- Cieslak, Paul. et.al. (1997). *Hamburger-Associated Escherichia coli O157:H7 Infection in Las Vegas: A Hidden Epidemic*. American Journal of Public Health. Vol. 87 No. 2. Februari 1997.
- Haagsma, JA, et.al, (2013). *Review: systematic review of foodborne disease studies: quality assessment of data and methodology*. International Journal of Food Microbiology 166 (2013) 34-47.
- Kemenkes RI. (2012). *Pedoman Keamanan Pangan di Sekolah Dasar dan Madrasah Ibtidaiyah*. Direktorat Jenderal Bina Gizi dan KIA, Direktorat Bina Gizi. Jakarta.
- Kubik, MY, et.al (2003). *The Association of The School Food Environment with Dietary Behaviors of Young Adolescent*. American of Public Health. Vol. 93 No.7. Juli 2003.
- Lin, Chia-Min, et.al. (2003). *A Comparison of Hand Washing Techniques to Remove Echerichia coli dan Caliciviruses under Natural or Artificial Fingernails*. Journal of Food Protection. No.12. December 2003. p 2196-2405.
- Mensah, Patience, (2002). *Foodborne Diseases Surveillance and Monitoring in Food Control*, WHO.
- Nunes, MM, et.al (2013). *Food Control*. No. 34 (Tahun 2013). P 235-240.
- Puspitasari, RL (2013). *Kualitas Jajanan Siswa di Sekolah Dasar*. Jurnal Al-Azhar Indonesi : Seri Sains dan Teknologi. Vol.2 No.1 Maret 2013 p52-56.
- Rozendaal, JA. (1997). *Vector Control: Methods for Use by Individuals dan Communities*. WHO. Geneva.
- Sandjaja, et al., (2009). *Kamus Gizi-Pelengkap Kesehatan Keluarga*. Penerbit Buku Kompas. Jakarta.
- Sholikhah, HH & F, Sustini (2013). *Description of Clean and Healty Behavior of Food Borne Disease Among by School Children Age in Babat Jerawat I Elementary School, District Pakal, Surabaya*. Buletin Penelitian Sistem Kesehatan. Vol.16 No.4. Oktober 2013 p351-362.
- Syahrul, Fariani, M. Atoillah I., (2011). *Analysis of Foodborne Diseases Risk Factors in Elementary School by Canteen at School*. Surabaya. Airlangga University.
- Torgerson, PR., Nilanthi R. de Silva, Eric M. Fevre, Fumiko K., M.B. Rokni., Xiao-Nong Z., Banchob S, Neyla G, Arve L.W., dan Claudia Stein, (2014). *The global burden of foodborne parasitic diseases: An update*. Trend in Parasitology, January 2014, Vol.30, No.1.

# STUDY ON THE INDICATORS VILLAGE AWARE (CONCERNED) HIV-AIDS IN INDONESIA

<sup>1,2</sup>Ferry Febriansyah

<sup>1</sup> Marga Asri st. VI F Number C.195 Bandung West Java, ferry.febrian23@gmail.com, 081320456294  
<sup>2</sup> Postgraduate, Faculty of Public Health, University of Indonesia, Depok, Indonesia

## Abstract.

**Introduction:** HIV-AIDS cases has been showed an increasing rate in Indonesia. Preventing and reducing risk of HIV transmission as well as reducing the social and economic impact of HIV-AIDS, one of the strategies is to create an empowered people, therefore civil society can contribute significantly. To portray a society that has the power in preventing and controlling HIV-AIDS, can be seen from the level of awareness/community involvement which is demonstrated in addressing various issues related to HIV-AIDS. The level of awareness is reflected in the various components, which is subsequently identified to be an indicator of public concern.

**Methods:** Used methods in this analysis are literature review and qualitative study. Data collection technique using indepth interview, focus grup discussion and observation. Qualitative study conducted in 22 group Concerned Citizens AIDS spread in 11 districts / cities in Indonesia with a total of 110 informants.

**Results:** The results of qualitative studiesis coupled with the results ofthe literature review, concluded that the village aware (concerned) for HIV-AIDS have components: (1) Human Resources/Mobilization; (2) Forum; (3) Rules/Legality; (4) Media (Information, Education and Communication); (5) Funds; (6) Activity; and (7) Elimination of Stigma and Discrimination.

**Discusion:** The study was carried out until the stage of determination of indicators, therefore it is necessary to test the application of these indicators in society.

**Keywords:** *hiv-aids, indicator, village*

## 1 Introduction

Currently, HIV and AIDS is still a major public health problem in Indonesia. The cumulative incidence of HIV and AIDS show an increasing rate. The Ministry of Health recorded up to March 2013 was reported as 103 759 people infected with HIV, the AIDS cases reached 43 374 people. It is estimated that by 2020 this figure will reach about 2,463,901 people. Although the variation of HIV-AIDS cases among different regions in Indonesia, however, almost all districts / cities in Indonesia has reported cases of HIV-AIDS (Kemenkes RI, 2013).

To prevent and reduce the risk of HIV transmission, improve the quality of life of people living with HIV, and reduce the social and economic impact of HIV-AIDS both on individuals, families and communities, one of the established strategy is to create an enabling environment, which is a condition civil society can contribute significantly (KPAN, 2010). Community empowerment is seen quite effective in supporting the success of the program, in which community involvement can significantly increase self-efficacy and scope of the program (Blanchard et al, 2013), expanding cadre of society, strengthening relationships with community-based organizations and community participation in the monitoring program, supports the existence of a social community leaders, behavior change communication, peer support and participatory approaches in the search for common solutions and practices to create a conducive environment (Gulaid and Kiragu, 2012).

Some research indicates that community empowerment is a potentially effective strategy to address the shortage of health workers, expanding care and accommodate the needs associated with HIV-AIDS. Empirically shows that community empowerment programs, though not always cheap or easy,

remains a good investment to improve health care coverage required (Wouters et al, 2012). It is very reasonable considering that empowerment will give birth to a society that is able to identify the problems faced, formulate alternative solutions to problems, to organize themselves, to develop the rules, values, norms were developed, agreed and adhered together, and expand cooperation and able to forge partnerships.

To portray a society that has the ability (power) in the prevention and treatment of HIV-AIDS, can be seen from the level of awareness / community involvement demonstrated in addressing various issues related to HIV-AIDS. The level of public awareness of this will be reflected in the various components, such as the level of participation, leadership, ability to assess problems, organizational structure, resource mobilization, and so forth. These components can then be identified to serve as an indicator that indicates the level of public awareness.

## **2 Benefit**

Support accelerated realization of rural communities / villages matter who has the ability to identify, define goals, mobilize existing resources and to develop and implement strategies to address the problem of HIV-AIDS.

## **3 Scope**

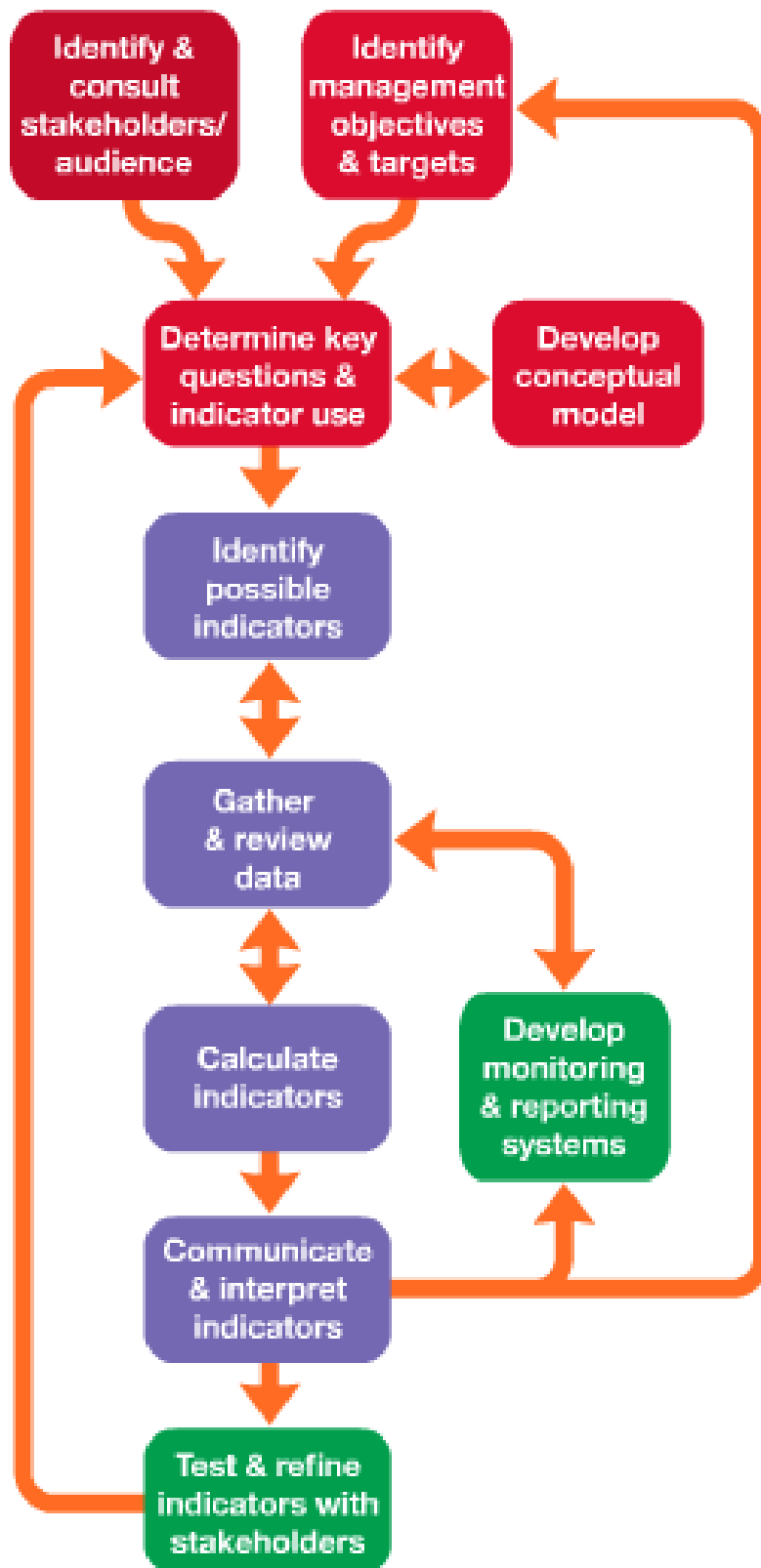
Indicators of village aware (concerned) HIV-AIDS is a study results through field surveys and through the literature search to identify various activities and community activities related to the prevention and treatment of HIV-AIDS. Conduct an analysis of empirical experience community with a conceptual approach that can be formulated a concept of indicators that reflect a society / village with a concern for HIV-AIDS.

## **4 Process Studies**

The study was conducted by using the approach of the concept of the development of indicators (figure 1), to make some adjustments. In detail, the development of indicators rural / urban villages of HIV-AIDS in stages as follows:

1. Conduct meetings with collegiate P2NHA training (care drugs, HIV-AIDS) to discuss the importance of public awareness of the problem of HIV-AIDS and ways to measure it.
2. Conduct meetings with relevant stakeholders, such as the National AIDS Commission and the Department of Health of a City / County in West Java, namely Cianjur, Cirebon, Indramayu, and Bogor to identify the needs of the target program and management as well as important issues related to HIV-AIDS.
3. Synthesis with collegiate of training and stakeholder to identify variables that could potentially be a candidate indicator / District Village HIV-AIDS care.
4. Conduct literature reviews related to the social order of HIV-AIDS care Along with the activities of phase 1) to 3).
5. Field study of a number of Community Care for HIV-AIDS. Field studies conducted with a qualitative approach using in-depth interviews.
6. Compile the results of training collegiate and stakeholders meeting with the results of field studies and discussions with experts to identify indicators, develop a conceptual model (definition and interpretation) to determine and explain the relationship between indicators and objectives.
7. Perfecting the draft indicator of the overall results of the previous stages.

figure.1



source:bipnational.net



## 5 Methods

Used methods in this analysis are literature review and qualitative study. The literature review was done by searching the literature on community involvement in prevention and treatment of HIV-AIDS, and the concept of the selection of indicators. The literature review is intended to identify the various concepts of shapes, components, factors that affect the success of community involvement, as well as how to prepare and develop indicators. Data collection technique using indepth interview, focus grup discussion and observation with non probability sampling technique. Qualitative study conducted in 22 group Concerned Citizens AIDS spread in 11 districts / cities in Indonesia with a total of 110 informants with purposive sampling method.

To obtain empirical data in the field, the literature review combined with qualitative studies conducted through several stages such as discussions with collegiate of the training participants, stakeholders, relevant experts, as well as field studies in 9 provinces and 11 city/district (Padang, Jambi, Bandung, Solo, Semarang, Kediri, Surabaya, Denpasar, Mataram, Pontianak, Makassar) between August-November 2013.

## 6 Results

Village Care of HIV-AIDS is a development which has been initiated by BBPK Ciloto since 2011. In the beginning, the concept was developed in order schools, boarding schools, and villages in several cities in the partners province of BBPK Ciloto, namely Papua, East Nusa Tenggara, Aceh, Lampung, Bengkulu Cianjur, Sukabumi, Depok and Bekasi. This concept is ultimately focused on the establishment of the order of Village Care of HIV-AIDS. Village Aware (concerned) of HIV-AIDS are:

- a. The people are conscious (aware) of the dangers of HIV-AIDS to actively participate mobilize resources (personnel, facilities, funds, etc.) that exist for the prevention and control of HIV-AIDS.
- b. The people in groups conducting community-based active, systemic and sustainable in order to support efforts to prevent and control HIV-AIDS to create an environment free of stigma and discrimination.

Based on these definitions, village aware (concerned) of HIV-AIDS have components: (1) Human Resources/Mobilization; (2) Forum; (3) Rules/Legality; (4) Media (Information, Education and Communication); (5) Funds; (6) Activity; and (7) Elimination of Stigma and Discrimination.

### 1) Human Resources (Mobilization)

Driving force in the village aware (concerned) of HIV-AIDS is a person who moves / initiate community involvement in the prevention and treatment of HIV-AIDS in the village. Propulsion can come from health workers, community leaders, traditional leaders, religious leaders, etc.

### 2) Forum

One of the stages in the development of society is characterized by the presence of active community involvement in a dialogue together to identify and solve problems together, through a meeting, which in this case is called the forum. Forums in the village aware (concerned) of HIV-AIDS is defined as a vehicle or container gather interest groups to discuss issues related to HIV-AIDS, held at the village. In addition, the forum also for the coordination of the driving force in making the program / activities related to HIV-AIDS. The forum in the village / sub-Care HIV-AIDS is not always the forum formed specifically related to HIV-AIDS, but can also be a forum that has been running, such as a forum or forums standby villages other villages but can be used for programs / activities related to HIV-AIDS.

### 3) Rules / Legality

Village aware (concerned) of HIV-AIDS is expected to have legality / rules in the village / village either Circular (SE), Decree (SK), or Village Regulation (Perdes) associated with HIV-AIDS mitigation. Rules / Legality Village / Village Care for HIV-AIDS are provisions, instructions or commands that are designated as legal basis for the sustainability of the activities or organizational prevention and control of HIV-AIDS in the community.

#### 4) Infrastructure (Information, Education and Communication)

Facilities and infrastructure are the tools or materials used to perform an activity. The event, which is expected to be in a community, village aware (concerned) for HIV-AIDS is the implementation of the IEC (Information, Education and Communication) on HIV-AIDS. So on this concept called the infrastructure are tools or materials used for HIV-AIDS information, education and communication activities.

#### 5) Funds

In this context, fund is defined as a resource either money or goods that are used to organize activities related to the prevention of HIV-AIDS in the village.

#### 6) Activity

Activities undertaken in the village aware (concerned) for HIV-AIDS is defined as all activities are carried out collectively as the prevention and control of HIV-AIDS, such as counseling, IEC, and mentoring.

#### 7) Stigma and Discrimination

Stigma and discrimination against people living with HIV is a community treatments, whether accepted or excluded.

In detail, the seven indicators assessment village aware (concerned) for HIV-AIDS is described as follows:

### Indicators and Assessment Variables

#### 1. Human resources

##### 1.1 Variable: existence of human resource/driving force

- Question: people who active in prevention and mitigation activity HIV-AIDS in this village?
- Verification: interview, research paper
- Information source: village heads, kader, community

##### 1.2 Variable: amount of human resource

- Question: how many people who active in this activity at the village?
- Verification: interview, research paper
- Information source: village heads, kader, community, provision

##### 1.3 Variable: amount of element human resource

- Question: which element of human resource come from?
- Verification: interview
- Information source: village heads, kader, community, provision

##### 1.4 Amount of training human resource

- Question: How many people it is trained have been active?
- Verification: interview
- Information source: village heads, kader, community, provision

##### 1.5 Level of knowledge kader about HIV-AIDS

- Question: Average knowledge score of kader
- Verification: questioner
- Information source: all of kader

2. Forum
  - 2.1 Feasebility forum
    - Question: there is a feasible forum for community to develop and participate in prevention and mitigation HIV-AIDS in the village?
    - Verification: interview, document (\*if there is)
    - Information source: village heads, cader, community
  - 2.2 Forum perform actively
    - Question: how activity frequency forum?
    - Verification: interview, document (\*if there is)
    - Information source: village heads, cader, community
3. legality
  - 3.1 written regulation in level of village or sub-district regulate about prevention and mitigation HIV-AIDS
    - Question: there is a written regulation in level of village or sub-district regulate about prevention and mitigation HIV-AIDS?
    - Verification: interview, research paper
    - Information source: village heads, cader, community, provision, other regulations
4. Infrastructure
  - 4.1 Media information about HIV-AIDS
    - Question: there is available media information about HIV-AIDS?
    - Verification: interview, observation
    - Information source: cader, community, surveyor conduct observation in the community
  - 4.2 Variation of media that exist in the village facilitated by local community
    - Question: what other media that is available about prevention and mitigation HIV-AIDS in the village? (except media information from national source)
    - Verification: interview
    - Information source: cader, community
5. Funds
  - 5.1 Funding for HIV-AIDS activity in the village
    - Question: there is available funding for HIV-AIDS activity?
    - Verification: interview
    - Information source: village heads, cader, community
  - 5.2 Independency in funding for HIV-AIDS activity in the village
    - Question: main source funding for HIV-AIDS activity?
    - Verification: interview
    - Information source: village heads, cader, community
6. Activity
  - 6.1 Existence activity about HIV-AIDS in the village
    - Question: there is an activity about HIV-AIDS conducted in the village?
    - Verification: interview, research paper, report
    - Information source: village heads, cader, community
  - 6.2 Variation activity about HIV-AIDS in the village
    - Question: what is an perform activity about HIV-AIDS conducted in the village?
    - Verification: interview, research paper, report
    - Information source: village heads, cader, community
  - 6.3 Amount of activity about HIV-AIDS in the village in a year
    - Question: how many activity about HIV-AIDS in the village in a year?
    - Verification: interview, research paper, report
    - Information source: village heads, cader, community
  - 6.4 Level of participation community about HIV-AIDS in the village
    - Question: how many people involve and participation from the target population?
    - Verification: interview, research paper, report
    - Information source: village heads, cader, community
  - 6.5 Documentation about HIV-AIDS in the village
    - Question: how format of documentation about HIV-AIDS in the village?
    - Verification: interview, research paper, report
    - Information source: village heads, cader, community

## 7. Stigma and discrimination

### 7.1 Acceptance community about people living with HIV-AIDS

- Question: how about acceptance community about people living with HIV-AIDS?
- Verification: interview
- Information source: village heads, kader, community

## 7 Limitations

The study was carried out until the stage of determination of indicators, therefore it is necessary to test the application of these indicators in society.

## 8 Nomenclature

BBPK Ciloto = Balai Besar Pelatihan Kesehatan Ciloto

IEC = Information, Education and Communication

P2NHA = Pencegahan dan Penanggulangan Napza, HIV dan AIDS

Perdes = Peraturan Desa

SE = Surat Edaran

SK = Surat Keputusan

## 9 References

*Permenkes no 13 Tahun 2013 tentang Penanggulangan HIV.*

Kemenkes RI, 2013. *Laporan Perkembangan HIV-AIDS Triwulan I Tahun 2013*. Ditjen P2PL-Kemenkes RI. Jakarta.

Komisi Penanggulangan AIDS Nasional (KPAN). 2010. *Strategi dan Rencana Aksi Nasional (SRAN) Penanggulangan HIV dan AIDS 2010-2014*. KPAN. Jakarta.

Blanchard et. al., 2013. *Community mobilization, empowerment and HIV prevention among female sex workers in south India*. BMC Public Health 2013, 13:234. dalam <http://www.biomedcentral.com/1471-2458/13/234>

Gulaid, Laurie Ackerman dan Karusa Kiragu. 2012. *Lessons learnt from promising practices in community engagement for the elimination of new HIV infections in children by 2015 and keeping their mothers alive: summary of a desk review*. Journal of the International AIDS Society 2012, 15(Suppl 2):17390

Wouters et al, 2012. *Impact of community-based support services on antiretroviral treatment programme delivery and outcomes in resource-limited countries: a synthetic review*. BMC Health Services Research 2012, 12:194

## **Acknowledgement**

Ciloto Health Training Center, The Agency for development and empowerment human resources of health, Ministry of Health Republic of Indonesia.

Department of Health of a City / County (Padang, Jambi, Bandung, Solo, Semarang, Kediri, Surabaya, Denpasar, Mataram, Pontianak, Makasar, dan Cirebon).

National AIDS Commission City / County (Padang, Jambi, Bandung, Solo, Semarang, Kediri, Surabaya, Denpasar, Mataram, Pontianak, Makasar, dan Cirebon).

# THE FACTORS WHICH AFFECT THE PROFESSIONALISM DEVELOPMENT OF GOVERNAMENTAL APPARATUS

Dr. Bambang Sudaryana, M.Si.

[sudaryana\\_bambang@yahoo.com](mailto:sudaryana_bambang@yahoo.com), +628522253132

## Abstract

In the era of regional autonomy, are necessary a lot of efforts to improve the quality of local government officials, in order to be able to have a high performance in carrying out basic tasks, functions, and responsibilities. The research problems are how much policy, educational background, training hierarchy structural, functional and technical training influence the quality of the performance of government officials.

The purpose of this research is to study, examine, and analyze the effect of policy professional development, educational background of local government officials, and improving the quality of the performance of local government officials.

Based on the analysis, it is known that the Functional Technical Training is the biggest variable influencing the quality of personnel performance that is equal to 27.270%, 11.813% Policy, Structural hierarchical arrangements of 6.9% Training and Educational Background latter by 5.8%. The number of overall influence on the quality of personnel performance is equal to 51.782%

**Keywords:** *Education, Performance, Policy, Quality, Training*

## 1 Introduction

With the enactment of the provisions of Act No. 32 of 2004, there will be a shift in the centers of authority in the governance and development of the center to the regions. Essence of the decentralization policy is the government try to get closer to the governed (the people). With the expectation that near the government is able to recognize / know all about the problems, needs, and aspirations of the communities it serves. Then, as a logical consequence of the increase in the regional authority, must be followed by increasing accountability of local government agency performance in governance in the region.

The paradigm of governance, development, and community service has experienced a shift from rule government became good governance. Governance, development, and public service, based on this paradigm are not only based on rules alone (rule) or government (Government), but also need to involve other domains, namely the private sector (Private Sector) and society (Civil Society).

Facing these dynamics, we need a strategic approach to major in public Administration, which reflects the approach leap improvement of quality and resilience (Tamin, 2004: 17). These aspects are very important and should be continuous, with solid governmental organizations and high-performance which is imperative. Conceptually, high quality, and continuous flexibility in the care of the organization and functioning of good governance are associated with professionalism and responsiveness of the apparatus to the needs and expectations of the people who influenced the development of (challenges and opportunities) national strategic environment, regional, and global. It is thus the local government officials should always build competence himself, government officials must also be willing and able to change their position and role in providing public services. In addition they are also required to be a professional in performing basic tasks, functions, powers, and responsibilities that have been mandated by the people to him. Professionalism is more directed to the attitudes and behavior of the local government apparatus that is able to be responsible and accountable for all the attitudes, behaviors, actions, and policies that do to the public. Therefore they should have the competence, being democratic, responsive, and adaptive in performing all the duties and functions. Each organization is required to develop quality human resources. The main capital of

the competition is no longer in the form of money, but the intellectual capital (intellectual capital). In other words, build quality human resources in order to become the intellectual capital of the organization is done through the creation of a learning organization (learning organization). Speaking of learning organizations will not be separated from the opinion of Sange (1990) monumental book titled "The Fifth Discipline: The Art and Practice of Learning Organization".

The fifth discipline that needs to be built into the learning organization is to familiarize each member to have the same goal ie achieving organizational goals. In order to achieve the four other disciplines, namely: 1) personal maturity (personal mastery), 2) mental models (mental models), 3) building a vision (shared vision), 4) learning team (team learning).

In 2004 through the Government Performance Accountability Report (LAKIP) was shown quite alarming that of the 458 well Alumni Leadership Training Diklatpim II, Diklatpim III, or IV Dilatpim, only 196 people, or 42.80% increased performance. This means that the study shows the quality of the performance of government officials is still not optimal.

Besidethat, a lot of public complain against the performance of local government officials, especially the time of service, officer behavior, level of service, and bureaucratic procedures of licensing services. In connection with this, of course, the demands will be the attitude to improve the quality of performance of the apparatus as well as the attitude of professionals that must be owned by all government officials.

Efforts to improve the quality of the performance of local government officials, have been carried out by the City / County line with the policy of professional development through education and training, both structural and hierarchical arrangements Training Technical Training Functional

In connection with the above-mentioned phenomenon, the author conducted the research / deep study of policy development capabilities of professional development, the educational background based on local government officials through training hierarchical arrangements of Structural and Functional Technical Training in improving the quality of the performance of local government officials.

## **2. Problem Statement**

Based on the restriction of the problem, then raised the general statement of the research problem is How much influence policy variables (X1), Background Education (X2), Training hierarchical arrangements of structural (X3), Functional and Technical Training (X4) on the Quality Performance of Local Government Reform ( Y), either individually or jointly

Based on the statement of the problem, then the focus of the problem in this study can be formulated as follows:

- a. How much influence policy and Background Education on Training Structural hierarchical arrangements?;
- b. How much influence policy and Background of Education on Technical Training Functional?;
- c. How big influence policy, Education and Training Background Structural hierarchical arrangements on the Technical Training Functional ?;
- d. How much influence Background Policy and Performance Quality Education on the Local Government Reform?;
- e. How much influence policy, Education and Training Background hierarchical arrangements on the Quality Performance Structural Reform of Local Government?;
- f. How much influence policy, educational background, training hierarchical arrangements of structural, functional and technical training on the Quality of Local Government Apparatus performance ?.

## **3. Purpose and Objective**

This study intends to describe, assess and analyze the process of policy implementation professional development and educational background of personnel / employees and their effect on improving the quality of the performance of local government officials by the local government as well as aspects related thereto, as part of the implementation of government policy to build quality of the performance of local government officials.

The aim is to study, assess and analyze the effect of the policy on professional development, educational background of local government officials, and improving the quality of the performance of local government officials. Therefore the aim of this study are as follows:

- a. To get an overview of the empirical policy variables, Background Education, Training hierarchical arrangements of Structural, Functional and Technical Training on the quality of the performance of local government officials.
- b. To identify the effect of policy alternatives, Background Education, Training hierarchical arrangements of Structural, Functional and Technical Training on the quality of the performance of local government officials.

#### **4. Benefits of The Research**

This research is expected to have the following benefits:

- a. Academically is that this research will provide a positive contribution to the development of theory or educational policy studies and training personnel, as part of government policy (public policy) as well as part of a study of educational administration. More specifically expected to be an important part of the development of the theory of education policy implementation, as part of government policy study recently revealed to be studied more in depth;
- b. Practically-institutional, namely that the study results can be useful for Local Government and Training Agency as part of the implementing agent of the government policy to develop human resources. More specifically useful for decision makers (decision makers) at various levels of the organization in the City / district about how to develop and empower local government officials as an integral part of human resource management (human resource management). With the results of this study are expected to increase the quality of the performance of local government officials do in the future is to support efforts to achieve the tasks, functions and authority of the Education and Training as educational institutions and training apparatus.

#### **5. Framework**

The framework of this study can be expressed visually schematic as shown in the figure below:

Good governance (good governance) is closely related to the accountability of public administration in carrying out the duties, functions and responsibilities. Government is essentially to serve to the public, not to serve themselves, as well as to create conditions that allow every member of the community to develop the ability and creativity to achieve a common goal that has been set.

In its implementation requires the involvement of all stakeholders or the elements that exist in the community, this can happen when the system of decentralization and regional autonomy means that the government is able to run brought closer to the governed. Enabling governments to identify what the community needs, problems, desires, interests, and aspirations of its people properly, because the policy will be made should reflect all the interests and aspirations of the people.

Government policies to realize the condition of good governance, are a challenge and an opportunity for the City of Tasikmalaya to build the area towards improving the quality of performance of local government officials as a driver of development.

Education is an investment in human resources which have competence, and the quality will be the driving force for the implementation of governance, development, and community. Accordingly, based on the concept of human resource development that has human resources and strategic position play a contributive role that is no less important in other fields. Development of human resources in the era of regional autonomy can be abenefit to have superior competence through a process that is the implementation of education.

That the development of human resources is designed to handle multiple services related to the development / growth of employees, professional capacity, solving staffing problems, staffing system improvement activities, providing motivation to employees, the tendency of mobility and protection of



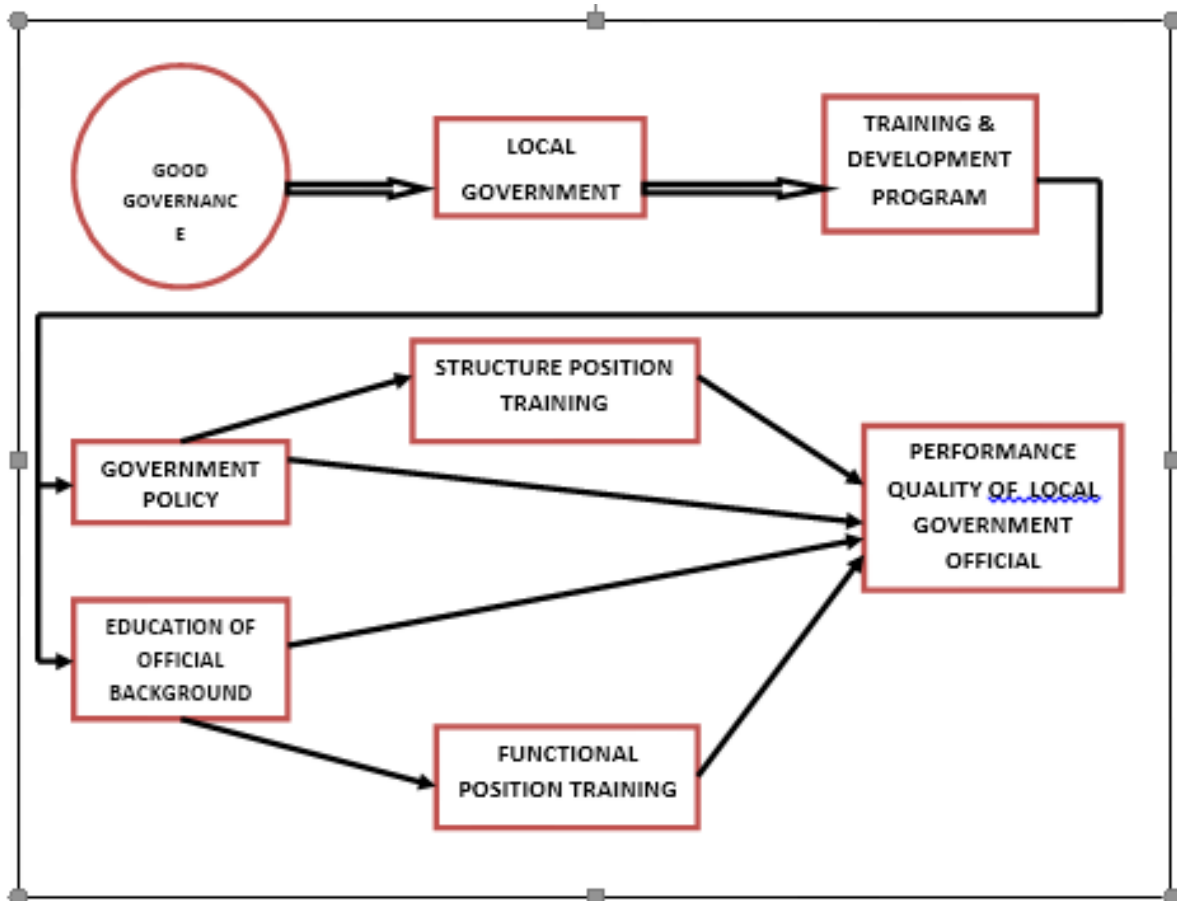


Figure 1. Framework

employees in improving employee performance. The focus of this research is on the human resources of local government officials.

The needs of skilled manpower in various fields has been a global world demand that can not be postponed. And in the present, in the era of competition, should be aware that each institution is required to have the ability to create a qualified professional development plan.

From the above concept, is clear that professional development of apparatus through formal education and training is an effort in the development of human resources to be able to become a benefit the wider community and himself.

## 6. Hypothesis

Based on the assumption that the study mentioned above, then the hypothesis of this study are:

- Policies and Educational Background The ranking Structural influence on training.
- Policies and Background Education Technical Training Functional effect on.
- Policy, Education and Training Background The ranking Structural effect on Functional Technical Training.
- Policies and Educational Background affect the quality performance of Regional Government Agencies.
- Policy, Education and Training Background The ranking Structural affect the performance quality of the Local Government Reform.
- Policy, educational background, training hierarchical arrangements of structural, functional and technical training effect on the quality of performance of Local Government Reform.

## 7. Research Methods

The method used in this study is a descriptive survey research method-analytic form using data from respondents. Data are obtained through the questionnaire, interviews, and field observations. The process of development of research instruments for collecting data were: (a). Employment Guidelines; (B). Observation pre-study; (C). The results of discussions with the lecturers, organizers of Education and Training, Education And Training Agency West Java, Alumni Workshop Participants

hierarchical arrangements of Structural Diklapim (II, III, IV) and Alumni Functional Technical Training; and (d). References related to this research. Then the data analysis in this study, using correlation and regression analysis techniques path analysis (*path analysis*). (Sitepu, 2004)

## 8. Research Samples

### A. sample

Research used the sample of 280 people made up as follows:

- a. Training Alumni Adum / Pim IV ( General Administration Structural Training IV) 87 peoples
- b. Training Alumni Spama / Pim III ( The Leader Structural Training III) 66 peoples
- c. Training Alumni Pim II ( The leader Structural Training II) 27 Peoples
- d. Citizens 100 Peoples

The samples above are based on a stratified random sampling, this is due to the heterogeneous population, the population is divided by strata.

### B. Basic Theory

Some strategies to improve the professionalism of the bureaucracy required by good governance are:

Role Modeling. standards of conduct and behavior patterns bureaucrats formed among others by example; Recruitment. Objective recruitment process, conducive working conditions and training using methodical and precise didactic an effective discourse of professionalism formation. Learning Process Approach, is a discourse that is effective for the formation of this professionalism, bureaucrats will learn effective (learning to be effective) and from there will move towards efficient learning (learning to be efficient), and ultimately developing learning (learning to be expand). Formation of professionalism should be done together with the strengthening of the organization (organizational strengthening) focusing on management systems to improve performance on the microstructure and institutional reforms (institutional reform) focusing on macro-institutional structure, and the formation of professionalism requires social control of civil society .Korten (In Tjokrowinoto, 2007: 11-13)

According to Shamsuddin (2006: 13), that education personnel is a determinant component in the implementation of human resource development and occupies a key position in the national education system. Impact quality professional ability and performance not only will contribute to the quality of graduates is the output, but also continues on the quality of performance and services graduates (outcomes) in the development, which in turn will then be visible influence on the quality of life of civilization and dignity of the people, nation and mankind in general.

And then Mangkunagara (2008: 67) that the performance of human resources is the job performance or work (outputs) of both quality and quantity of human resources is achieved by the union of the period of time in carrying out his duties in accordance with the responsibilities assigned to him.

To determine the level of performance necessary to design the system performance evaluator. Schuler Et al (1996.350-351) argues that there are three kinds of performance assessment criteria:

1. Trait-based criteria that measure and evaluate what is done by HR. These criteria are useful to assess the knowledge and skills / expertise HR
2. Behavior-based criteria that measure and evaluate the attitudes and behavior of HR work
3. Outcome-based criteria that measure and evaluate the work of HR.

Furthermore Jones (in Widodo, 2007: 191) defines public policy implementation as getting the job done and doing it. Such a notion is certainly a very simple notion.

Arikunto (1988: 79) suggests that one way of handling workers (personnel) is the "way of coaching". Coaching (development) in question is to improve the quality of personnel, whether done through training as well as on other occasions, such as inservice training, upgrading, scientific discussions, workshops, and others.

### C. Research

- I. I The relationship between policy (X1), and Background Education (X2), Structural hierarchical arrangements Training (X3) and Functional Technical Training (X4) and Quality Performance Apparatus based on the results of the calculation of the correlation coefficient has the greatest relationship is the relationship between the variables Functional Technical Training (X4) with Variable Quality of Government Personnel Performance (Y) that is equal to 0.6067, while the variable that has the smallest relations policy variables (X1) with variable Training Functional Technical amounting to 0.2052.

- II. The relationship between policy (X1), and Background Education (X2), Structural hierarchical arrangements Training (X3) and Functional Technical Training (X4) with Quality Performance Apparatus multiple correlation coefficient, Relationship between Policy (X1), Background Education (X2), Structural hierarchical arrangements Training (X3) Technical Training Functional (X4) and Quality Performance shown Apparatus of 0.720 means that the connection is tight enough. The  $R^2 = 0.518$  means that changes in the quality of personnel performance by 51.78% due to changes in the Background of Education (X2), Structural hierarchical arrangements Training (X3) Functional and Technical Training (X4).
- III. Influence of Policies (X1), and Background Education (X2), Against The ranking Structural Training (X3). Influence policy across variables (X1) and Background Education (X2), to the hierarchical arrangements of Structural Training (X3) is equal to  $R^2 = 0.1100$ , meaning Policy (X1) and Background Education (X2) has the effect of 11% of the The ranking changes in the variables of Structural Training (X3). And the influence of other variables at 0.9434, or by 89% performance influenced by other factors that are not included in the study variables.
- IV. Influence of Policies (X1), and Background Education (X2), Against Functional Technical Training (X4). Influence policy across variables (X1) and Background Education (X2), of the Functional Technical Training (X4) is equal to 0.086 meaning Policy (X1) and Background Education (X2) has the effect of 8.6% of the change in the variable Functional Technical Training (X4). And the influence of other variables of 0.956, or 91.4% of performance is affected by other factors not included in the study variables.
- V. Effect of Policies (X1), Background Education (X2), and hierarchical arrangements Structural Training (X3) Against Functional Technical Training (X4). Influence policy across variables (X1) and Background Education (X2), of the Functional Technical Training (X4) is equal to 0.220, that is, policies (X1), Background Education (X2) and hierarchical arrangements Structural Training (X3) have an influence 22% of the change in the variable Functional Technical Training (X4). And the influence of other variables of 0.883, or 78% performance influenced by other factors that are not entered into the study variables.
- VI. Influence of Policies (X1), and Background Education (X2) on the Quality Performance Apparatus (Y). Influence policy across variables (X1) and Background Education (X2), the Quality Performance Apparatus (Y) is equal to 0.266, meaning Policy (X1) and Background Education (X2) has the effect of 26.6% of the changes in variable on the Quality Performance Apparatus (Y). And the influence of other variables at 0.8567 or 85.67% performance is affected by other factors that are not entered into the study variables.
- VII. Influence of Policies (X1), Background Education (X2), and hierarchical arrangements Structural Training (X3) on the Quality Performance Apparatus (Y). Influence policy across variables (X1) and Background Education (X2), the Quality Performance Apparatus (Y) is equal to 0.360 means, Policy (X1), Background Education (X2) and hierarchical arrangements Structural Training (X3) have the effect of 36% of the change in the variable on the Quality Performance Apparatus (Y). And the influence of other variables by 0,800, or by 64% performance influenced by other factors that are not entered into the study variables.
- VIII. Influence of Policies (X1), and Background Education (X2), Structural hierarchical arrangements Training (X3) Functional and Technical Training (X4) of the Local Government Personnel Performance Quality. Influence policy across variables (X1), Background Education (X2), Structural hierarchical arrangements Training (X3) Functional and Technical Training (X4) on the Quality Performance apparatus (Y) is equal to 0.518, meaning Policy (X1), Background Education (X2), Structural hierarchical arrangements Training (X3) Functional and Technical Training (X4) has the effect of 51.8% of the change in the variable quality of local government apparatus performance (Y). And the influence of other variables at 0.6944, or by 48.2% influenced by the performance of other factors that are not entered into the study variables.

## **9. Conclusions, Implications, and Recommendations**

### **a. Conclusion**

General conclusions from the results of these studies can be argued that the policy has the effect of 11.813%, Background of 5.80% Education, Training hierarchical arrangements of 6.90% Structural, Functional and Technical Training of 27.270%, which means a significant influence on the quality local government officials. And the overall effect of the independent variable on the dependent variable is the quality of the performance of local government officials at 51.782%

Quality Performance of Local Government Reform in 2003 was 49.56%; Quality Performance of Local Government Reform of 2004 was 42.80%; and based on this study in accordance with the test using path analysis obtained  $R^2 = 51.782\%$ . This means that every year the application of training material presented in the implementation of the training has not been optimized in order to improve the quality of the performance of local government officials.

### **b. Implications**

These improvements should pay attention to the results of empirical studies as follows:

1. It should be designed to accommodate personnel system reform civil service system within the framework of regional autonomy; develop the system towards democratization, professionalism, and performance-oriented; and prepare the system to be developed.
2. Policies professional development of local government officials should be adapted to the era of paradigm change in thinking and public demands higher, as well as the needs of professionals in the future.
3. Development of professional ability for local government officials, should be given stimulants in the form of underwriting all the costs of participation are basically government obligations.
4. Implementation Training apparatus both structurally and technically functional hierarchy, especially in teaching methods and media as well as the structure of the curriculum (teaching materials) to be adapted to structural job competency standards, and the number of hours of training each material tailored to the needs of the learning time for training participants, in order to obtain effectiveness and satisfaction of learning and in accordance with good learning domains of cognitive, affective, and psychomotor.
5. The mechanism of recruitment of training participants must go through a rigorous selection, accurate, transparent, and accountable
6. The learning process will be more effective and focused when performed by skilled trainers who have equivalent education basik S2 and S3, followed by empirical capability as an officer or other professional.
7. The ability of the organizers of the training should be improved in the ability of planning education and training, provision of means of learning and teaching, as well as the evaluation system.
8. The quality of government officials would increase if it has significant knowledge and capabilities with demand paradigm of governance and public interest, government bureaucracy that is able to meet customer satisfaction, has a visionary leadership, work ethic and high culture, as well as the accountability of the government apparatus good .
9. The proposed model tries closer fit between policy, professionalism, and quality performance of local government officials as public servants. Continuity to keep learning and education and training developed will be able to better ensure the success.
10. Implementation of training affects the quality of the performance of local government officials, but the effect is not optimal level given that there are several obstacles both technical and administrative. The proposed model tries to restore the function execution / implementation of the Institute of Public Administration (LAN) that it seems to be a professional researcher and proportionate to the operational facilities, qualified teachers (trainers), a curriculum which has been adapted to the changing demands, have the implementation of the performance evaluation system training and evaluation of training graduates, recruitment and selection system of training participants, as well as synergistic financing system in education in order to improve the quality of government officials.

### **c. Recommendation**

1. The Government, in terms of macro policy-setting education and training of government officials must be able to adapt to an era of change in various fields.
2. Trainers should be able to establish appropriate standards, adaptive and accountable, and capable of displaying the characteristics desired by the trainers training participants and Local Government.

3. Institute of Public Administration, should be able to improve the skills of trainers through continuing education or other training.
4. National Personnel Board, are able to create professional development policies with implications for the process of government officials, organizing, and financing
5. Training Agency, as the location of the process of education and training apparatus, can organize training with better performance and professional manner. Followed up with a recruitment policy of strict training participants and standardized.
6. Local Government should be able to provide the optimal budget for the improvement of the quality of personnel as well as the revitalization of local government officials.
7. To enable the principle of professionalism and neutrality, training and development of employees is based on the career system with emphasis on performance and competence
8. To be able to serve the community, the standard-setting achievements, job competency standards, as well as employee appraisal system, geared towards global standards.

## REFERENCES

- Anderson, JE. ( 1997 ). *Public Policy Making*, New York: Holt, Rine-Hart, and Wiston Inc.
- Alfonso, J Robert, et al (1981). *Instructional Supervision A. Behaviour System*, Boston: Allyn & Bacon, Inc
- Arif, Z. ( 2006 ). *Model Penyelenggaraan Diklat*. Bandung : Badan Diklat Regional Jawa Barat.
- Arcaro, Jerome S ( 2005) *Pendidikan Berbasis Mutu*. Yogyakarta, Pustaka Pelajar
- Azwar, S. ( 2009 ). *Metode Penelitian*. Yogyakarta: Pustaka Pelajar Offset.
- Castetter, W.B. ( 1996) *The Human Resource Function in Educational Administration*, Edisi ke 6, New Jersey, Prentice Hall
- Cresswel, J.W (1994). *Research Design, Qualitative and Quantitative Approach*. California – London – New Delhi : Sage Publication, Inc.
- Danim, Sudarwan .(2008) . *Inovasi Pendidikan, Dalam Upaya Peningkatan Profesionalisme Tenaga Kependidikan*. Bandung, Pustaka Setia
- Departemen Dalam Negeri. (2000 a). *Peraturan Pemerintah Nomor 101 Tahun 2000 tentang Pendidikan dan Pelatihan Jabatan Pegawai Negeri Sipil*. Jakarta: Depdagri.
- Departemen Dalam Negeri. (2000 b). *Materi Apresiasi Kebijakan Diklat Kepemimpinan*. Jakarta: Bandiklat Depdagri.
- Departemen Dalam Negeri. (2000 c). *Pedoman Kebijakan Umum Bidang Kediklatan Tahun 2000-2004*. Jakarta: Depdagri..
- Departemen Dalam Negeri. (2002 a). *Peraturan Pemerintah Nomor 13 Tahun 2002 tentang Perubahan Atas Peraturan Pemerintah Nomor 100 Tahun 2000 tentang Pengangkatan Jabatan Pegawai Negeri Sipil dalam Jabatan Struktural* . Jakarta: Depdagri.

- Deporter, B, et al. (1999). *Quantum Teaching : Orchestrating Student Succes*. Alih bahasa oleh Nilandari.(2000). Bandung : Kaifa.
- Dunn, W.N. (1981). *Public Policy Analysis : An Introduction*. USA : Prentice Hall ; Inc.
- Dunn, William N. (2000) . *Pengantar Analisis Kebijakan Publik*. Jogyakarta, Gajah Mada University Press
- Dwiyanto, Agus. (2006). *Reformasi Birokrasi Publik di Indonesia*. Jogyakarta, Pusat Studi Kependudukan dan Kebijakan Universitas Gajah Mada
- Dye, T. R. (1984) *Undertanding Public Policy*. New Jersey : Prentice Hall Inc, Englewood Cliffs.
- Ferdinand, Augusty. ( 2000) *Structural Equation Modeling. Dalam Penelitian Manajemen*. Semarang Badan Penerbit Universitas Diponegoro
- Harris, DJ. Jr. (1976). *Managing People at Work*. Santa Barbara New York. London-Sydney-Toronto : John Willey & Sons, Inc.
- Hays, William L . ( 1969). *Qualification in Psychology*. The University Of Michigan, New Delhi, Prentice Hall Of India Private Ltd
- Jenkins, W. I. (1978). *Policy Analysis*. Oxpord Martin Robertson.
- Kneller, G.F. (1971). *Introduction to the Phylosophy. Of Education* New York-Chichester – Brisbane – Toronto : John Willey and Sons, Inc.
- Kramar, R. P. McGraw, dan Schuler R. (1997). *Human Resource Management in Australia*. South Melbourne : Addison Wesley Longman Australia Pty. Limited.
- Laird, Dugan. (1995). *Training and Development*. Second Edition. New York: Addison Wesley Publishing Company
- Lembaga Administrasi Negara dan Badan Pengawas Keuangan dan Pembangunan. (2000). *Akuntabilitas dan Good Governance*. Jakarta : LAN.

# Students Recap In Problem Based Learning For Developing Mastery Of Integration Techniques Of Mathematics Teacher Candidates

<sup>1</sup>Afnaria

<sup>1</sup>Department of Mathematics Education, Faculty of Teaching and Education Science, Islamic University of North Sumatera (UISU), Medan, afnaria@uisu.ac.id, +628126501230

## Abstract.

As one of private university in North Sumatera, UISU should contribute in improving the quality and competencies of its graduated teachers. These are of course starting from while they were still teacher candidates. This study objective is to develop the mastery of integration techniques of mathematics teacher candidates in the calculus course at Mathematics Education Department with 12 students. The competency is developed by conducting the problem based learning (PBL) which is combined with students recap. The problem based learning is a collaborative learning that let students work in group instead of working for their own needs. That's why this strategy needs to combined with students recap strategy, so that they can develop their own learning while working in group. These strategies let students to be more confident to present their works alternately. They're trained to be able to work in team, to share information, and to teach each other among the group. Students became more creative in developing themselves and their capabilities to solve any kind of problems. The students recap in PBL also shows the increasing of the students' mastery of the prerequisites materials. These strategies influence the increasing of students learning result for 79.6%, which is a good influence category.

**Keywords:** *integration techniques, mathematics teacher candidates, problem based learning, students recap*

## 1. Introduction

UISU produces hundreds of teachers of several subjects every year. It gives a big contribution to deliver the professional teachers in North Sumatera and some region nearby. Good or bad the quality and competencies of teachers in community is starting while they were still teacher candidates. This is one big issue when the initial competencies test of all teachers in North Sumatera conducted in 2012, where the average value was 37.42 far below the national average value of 42.25. As one of the major universities in North Sumatera, UISU of course should take part of the responsibility in developing quality and competencies of its teacher candidates.

In order to get the qualified and competence teachers, it requires a series of appropriate treatments which are continue and unique according to their needs and characteristics. Especially in mathematics, it needs a special qualification and competency where the mastery of the concepts is absolute so that they will be able to teach well. Moreover, they have to master the teaching and learning technique to optimize the students' material mastery in the future.

This research objective is to develop the mastery of integration techniques of mathematics teacher candidates by conducting the *problem based learning* which is combined with *students recap*. Due to the weakness of this PBL strategy, that it is a collaborative learning, students still have to work for their own needs [1]. Therefore, this strategy is combined with students recap strategy, so that students can develop their own learning while working collaboratively in a group. By these strategies, each student has to make a deep analyze about a problem, starting from its prerequisites material including its solution. Students have to make a recap about the topic and problem including its theories. Students recap strategy allows them to make a complete summary about the topic according to their needs [5].

## 2. Literature Review

(Wagner, 2008) today's students must master seven survival skills in modern live, i.e.: critical thinking and problem solving, collaboration and leadership, agility and adaptability, initiative and entrepreneurialism, effective oral and written communication, accessing and analyzing information, also curiosity and imagination. A lecturer must redefine the instructions in order to get the skills that students need to be a lifelong learners, workers and citizens.

(Mink et al., 2010), teachers must be prepared to approach mathematics instruction through questions, explorations, and problem solving. While they are still students, they have to be taught how to question, to learn strategies about how to find the solution, to lead them to more questions, to more information resources, and to more solution in creative and meaningful ways.

(Levin, 2001) *Problem based learning* (PBL) is a strategy that is used for developing the students' capabilities in critical thinking and problem solving. It was initially used in medical education, but now it has been widely used at many other educations. This strategy allows students to discuss about a given problem in group, and then present it. The lecturer can act as a mentor, facilitator, assessor, etc.

(Duch, Groh, & Allen, 2001) a lecturer must be aware that a good PBL take more time than other learning strategies. Since students need time to collect all the references, to discuss and to analyze the problem. Therefore, the course schedule should be more flexible. The lecturer should have got the affirmation from all groups at the beginning of the course, so that each of them would be actively participated. PBL encourage students to work collaboratively, but students also need their own learning, and it doesn't mean that they are licensed to use other's work as their own.

(Silberman, 2005) *Students recap* gives students chance to make a recap about the material which is being studied according to their way and their point of view and then present it to others. Lecturer encourage the students to make a kind of recap which is easily presented, by giving a set of questions to guided their recap in a better systematical and complete material that suit the students' needs.

## 3. Research Methodology

This research conducted at Department of Mathematics Education, UISU. It's started from May until December of 2014, with 12 students of the third semester who take the calculus course. The topic to be discussed is the integration techniques. The research conducted in several steps [2], i.e.:

- a. Lecturer explained about the learning technique and learning outcomes.
- b. Students are given a pre-test.
- c. Students are divided into a group of 3-4.
- d. Lecture decides the topics to be discussed.
- e. Students start working in group; lecturer as guidance.
- f. Each group presents their works; lecturer as guidance and assessor.
- g. Lecturer and students make conclusion about the topic and make the recap.
- h. Students are asked to make self-evaluation about the topic and formulated their own learning; lecturer guides them to seek more information and references to complete their recap.
- i. Interview and analyze the students' recap.  
The lecturer conducts in-depth interviews with the students to gain an overview of the advantages and disadvantages of the applied learning strategies, and also get the direct impact for the increasing of their competencies.
- j. Students are given a post-test.

## 4. Result and Discussion

The problem based learning and students recap was implemented on calculus course, on the integration techniques subject. Right after they are aware of the learning techniques and the learning goals, they started to work in groups. From 12 students, divided into 4 groups, each consists of 3 students. The strategies syntaxes are as followed :

- *Students start working in groups*  
Students start to collect as much information and references as they can get about the integration techniques. Then, they identify the difficult words and making the recap of each technique. Students analyze the theory and concepts including its examples. Next, they choose



one problem to be presented. According to the chosen problem, students build the recap about its foundation theory that supporting the solution, and also its solution.

Each group's member has to make their own recap about theory, problem, and its solution.

Here, lecturer acts as mentor, both in the process of understanding the material, the discovery of solutions, as well as the preparation of a recap.

The discussion needs 1- 2 course meeting.

At the beginning, the students found it hard to understand about the concept of integration techniques. One of the causes is the lack of mastery of the concepts of the previous material. Thus, some students need more time to analyze the concepts, its pre-requisites concepts and then put them on the recap.

- *Presentation*

Each group presents their work. All members of the group forward as a moderator, presenters, and minutes. Here, the lecture acts as mentor and assessor. The other groups are allowed to ask questions about the presented topic. Based on the question and the input either from other group or lecturer, they revise and develop the recap. Next, students and lecturer make the conclusion about the topic.

If a group is considering to be failed on the presentation, they have to re-present it on the next meeting.

- *Students' self-evaluation*

The lecturer guides students to make self-evaluation about the topic. Then, ask and direct them to develop their recap by adding the supporting theories and its prerequisites that should have been mastered.

- *Assessment*

1. *Analysis and assessment of students recap*

Analysis conducted to gain the description about the increasing competencies of students according to what they are written about the prerequisites theories of the integration techniques on their recap. The results commonly showed that their prerequisites theories are lessen. These mean that they have gained the increasing understanding about the prerequisites theories which will give them a better foundation in understanding the next material.

2. *In-depth Interview*

The in-depth interviewed with students showed, as followed:

- a. Students are trained to be confident to present their works in public.
- b. Since there are questions and answers session, either from the other students or lecturer, they are challenged to completely master the presented topic.
- c. By other learning strategies, students don't feel the obligatory of having the references for such courses, but with these strategies, they are pushed to find as much references as they can get to achieve a better result.
- d. In the discussion process, students shared information to each other and teach each other about the material. And when they got stuck, they come to ask the lecturer, then the learning process become more personal in fixing the concepts that haven't mastered yet.

3. *Learning result*

Next, to see the influence of the strategies on the learning result, it was taken the pre-test and post-test (table 1). Data analyzed using SPSS 20.0, showed that the strategies influence the students learning result for 79.6% (table 2), which is a good influence category.

**Table 1.** Students' Pre-test and Post-test Result

Students	Pre-Test (X)	Post-Test (Y)
----------	--------------	---------------

A1	40	65
A2	80	90
A3	50	70
A4	40	65
A5	60	80
A6	40	60
A7	50	75
A8	60	75
A9	60	85
A10	60	70
A11	40	65
A12	50	75
Mean	52.5000	72.9167
std. deviation	12.15431	8.90820

**Table 2.** Model Summary<sup>b</sup>

Model	R	R Square	Adjusted R Square	Std. Error of the Estimate
1	.892 <sup>a</sup>	.796	.775	4.22143

By using these techniques, each student should review some problems, and find their solutions, while they have to build their own recap on such supporting material to solve the problems. In this case, each student may lead different supporting material on their recap, according to their previous knowledge. Hence, each of them is able to evaluate their own learning.

## 5. Conclusion

The students recap in problem based learning strategies result showed as followed:

- a. These strategies influence the increasing of learning result for 79.6% and 20.4% is influenced by other factors. These mean that these strategies are giving a good influence.
- b. It trained students to be brave to make presentation in public.
- c. Since there is a questions and answers session, either from the other students or lecturer, they are challenged to completely master the presented material.
- d. By other strategies, students have no obligatory to have the references of the course, but by these strategies, students are willing to collect as much references as they can get in order to have the best result.
- e. Students become more active in learning process, in here, lecturer acts as facilitator, mentor, coach and assessor.
- f. Students are trained working in team, sharing information, and teaching each other.
- g. By the students recap strategy, it is showed the increasing mastery of the prerequisites material.

## 6. References

Duch, B., Groh, S., & Allen, D. (2001). *The Power of Problem Based Learning* (1st ed.). Virginia: Stylus Publishing, LLC.

- Levin, B. (2001). *Energizing Teacher Education and Professional Development with Problem Based Learning*.
- Mink, D. V, Ph, D., Hall, E. J., Ed, D., Johnson, S., Kiley, K. R., ... Ed, M. (2010). *Strategies for Teaching Mathematics*. (S. Johnson, Ed.) (1st ed.). California: Shell Education.
- Silberman, M. (2005). *101 Ways to Make Training Active* (2nd ed.). San Francisco: John Wiley & Sons, Inc.
- Wagner, T. (2008). Rigor Redefined. Overcoming the Global Achievement Gap. *Educational Leadership*, 66(2), 20–24. Retrieved from <http://www.ascd.org/publications/educational-leadership/oct08/vol66/num02/Rigor-Redefined.aspx>

## **ACKNOWLEDGEMENT**

This research is part of decentralization grant from Indonesian Directorate General of Higher Education in 2014.

# The Challenge of Health Schools Program's (UKS) Implementation: The Role of Steering Committee

<sup>1</sup>Muji Sulistyowati, <sup>1</sup>Hario Megatsari

Department of Health Promotion and Behavior Science, Faculty of  
Public Health, University of Airlangga, Surabaya, Indonesia,  
[mujisulistyowati@gmail.com](mailto:mujisulistyowati@gmail.com), 08123269986

## Abstract

**Purpose-** In Indonesia, UKS should be executed by Steering Committee as a coordinator and Organizing Committee as an implementer at schools. The purpose of this study is to explore the role of Steering Committee in implementing UKS at elementary school, as well as Organizing Committee.

**Methods –** This paper presents the descriptive study with qualitative methods by interviewing in-depth with Head of District (Camat), Head of Health Center, and Education Coordinator at District (UPTD) in five districts at Surabaya City. The districts represent North, South, East, West, and Center of Surabaya. The UKS Organizing Committee in five schools represented those five areas is already obtained. There are Principals and teachers who responsible with UKS.

**Findings –** The Steering Committee is already exists, as well as Organizing Committee in each district samples. Unfortunately their existence was not sustainable. They were gathered only when facing an award, represented by minimalist achievement in UKS implementation in each sample schools. As a program, UKS should be implemented as a system that should be sustained.

**Program Implication –** It is needed socialization and material refreshing about UKS to the Steering Committee specifically. The elements and role of Steering Committee should be evaluated to the effectiveness UKS implementation.

**Keywords:** health school program, implementation, organizing committee, steering committee, uks

## 1 Introduction

In 1995 WHO issued a concept that called Health Promoting School (HPS), and it can be implemented by a holistic concept that involved physically, mental, environmental and social aspects. In the other hand, school have a significant and strategic role to increase and improve health community status. This argument is relevant because most of the time of the children (5-19 years old) is in the school. Based on the data released by Ministry of Education Republic of Indonesia in 2007, the amount of students in group age 7-12 years old are 25,409,200 and most of them (99.4%) are active in the educational proces. Meanwhile the amount of students in the group age of 13-15 years old are 12,070,200 and most of them (86.5%) are active in the school.

The Centre of Health Promotion, Ministry of Health Republic of Indonesia in 2007, stated that the aim of health promotion in school is to increase the knowledge, attitude and skill of school's members and neighbourhoods about preventing, mantaning and increasing health status which supported by the policy of healthy school. Indonesia developed *Usaha Kesehatan Sekolah* (UKS) as a form of HPS, and started a few decade ago. In 1984 UKS is formalised by a regulation which formed Steering Committee in all level of government. In 1991, the government also issued a regulation that signed by 4 ministries (Health Ministry, Religious Minstry, Education Ministry and Ministry of Home Affairs), it is called *Surat Keputusan Bersama* (SKB). The purpose of SKB is to manage and maintain UKS in all level of school (kindergarten until senior high school), and the SKB is renewed in 2003 (no 1/U/SKB/2003).

In 2008, the ministry of education stated that the purpose of UKS is to increase the quality of education and achievement of the student by increasing the healthy behaviors so that enable to create a comprehensive of Indonesian human beings. The regulation issued by the center of steering committee of UKS (2005) stated that the level of implemention in the UKS comprised in to 4 level : minimal, standard, optimal and perfect. The qualification of the level UKS is determined by the

fulfillment of TRIAS UKS (health education, health services and development of healthy school environment). A school that obtain very minimum condition in the TRIAS UKS is qualified as a minimal level, and in the other hand school that able to obtain maksimum condition is qualified as a perfect level.

Ministry of education (2007) stated that in general UKS hasn't reached the noble purpose. It is supported by researched that conducted by many institutions and researchers, such as Permatasari (2010), Ministry of Home affairs and others. Other researches also conclude the same things. For example, Limbu (2010) stated that the UKS in the elementary school in City of Malang is lack of infrastructures so that they can't perform very well in the implementation of UKS. The cause of the situation is financial barriers and human resources.

As mentioned above, there are a lot of barriers to implement UKS. One of the barrier is human resources barrier which is the steering committee. The purpose of this research is to explore the role of steering committee in terms of increasing the implementation of TRIAS UKS in the elementary school in City of Surabaya.

## **2 Metode**

This is a descriptive qualitative research and the design is a cross sectional. Qualitative approaches is conducted to obtain the deeper information from the informants. The location of the research is in the City of Surabaya and it was done from July-November 2014. The sample of the research is five elementary schools which represent 5 areas in Surabaya (Centre, North, South, West and East), and the method of sampling is random sampling. To get the information, the informants of the research comprise of organizing committee (5 principals) and steering committee (5 head of health centers, 5 person represents sub district, and 5 person represent ministry of education in the sub district level).

The variables of the research are knowledge, attitude, role and activeness of the steering committee and the relation with achieving TRIAS UKS in the school as a analysis unit. Content analysis are used to analyse the findings.

## **3 The Knowledge of Sterring committee about UKS**

The informants of sterring committee comprise of health center units, sub district, and representation of ministry of education in the sub district level (UPTD BPS = *Unit Pelaksana Teknis Dinas Bina Pengawas Sekolah*). UPTD BPS in the city of Surabaya is divided into 5 areas, each UPTD BPS responsible in some sub districts.

The terminolgy of knowledge in this research is the individual knowledge as a sterring committee to define UKS, the purpose of UKS, the target of UKS, the activities's form of UKS and SKB 4 ministries as a legal standing of implementation UKS

The result show that, in general, the sterring committee have a good knowledge about UKS. They don't specifically mention about the definition UKS, but they mention that UKS is related with health student. As mention below the quotation from the sub district grup :

*...Tentang kesehatan anak-anak. Tentang tempat belajar anak-anak. (Head of sub-district 3)  
(.about students health...)*

*Ya ini adalah salah satu usaha sekolah dalam rangka untuk yang pertama, meningkatkan kesehatan para siswa di sekolah, yang kedua juga meningkatkan kesadaran tentang arti hidup sehat sekolah (Head of sub-district 2)  
(one of the school program in gaining students health, and improving the awareness of healthy life at school)*

*UKS kan program tanggung jawab bersama dari sekolah dari kader-kader PKK, kelurahan, sampai kecamatan terus termasuk puskesmas tujuan dari UKS itu untuk mendeteksi kesehatan (UPTD 5)*

(UKS is the communal responsibility program...and to detect health)

Some informants also said that UKS is to educate students in the school and UKS is a precaution program to prevent student from sickness including the treatment system. Here are some comments from the informants

*..piye bocah-bocah iku diwarahi (=diajari) untuk bersih, berbenah, berbersih.. (Head of sub-district 3)*

( to teach children to clean and to tidy..)

*UKS itu kan memang untuk mendidik anak-anak sekolah,..(staff of sub-district 5)*

(UKS is to educate students)

*Trus juga disitu ada selain tindakan preventif ada pengobatan dalam rangka kalau ada siswa yang sakit,..(Head of sub-district 2)*

(..there are preventive and curative action...)

*Mengajarkan siswa tentang pentingnya kesehatan, lingkungan, kebersihan. (UPTD 5)*

(..to educate students about health and environments)

The opinion of informants about the definition and purpose UKS is already correct related which is educate students to practice healthy behavior. Meanwhile, the opinion of informants about the target of UKS is same in all elements in the school : students, teachers, headmaster, securities and canteen. Some informants add the parents and neighborhood as target of UKS.

Most of the informant relate the form of UKS as : to prevent the student from sickness, routine health examination conducted by health center, and an effort to accustom about healthy living and healthy behavior in the personal level and in the community level.

*Programnya ya pemeriksaan rutin itu. Pemeriksaan rutin dari petugas puskesmas. Terus...kebersihan... kebersihan, kantin sekolah ya masuk juga... tentang makanan-makanannya itu. Kader lingkungan, kader kesehatan, terus apa namanya...wamantik, siswa pemantau jentik....(staff of sub-district 1)*

(The program are routine health examination, clean environments, school canteen, about food too, and cadres)

*...Contoh di sekolah gerakan uks seperti cuci tangan sebelum makan, kalau ke kamar kecil disiram dulu sebelum menggunakan, mottonya sehat dimulai dari saya (UPTD 2)*

(the example of program are handwash before eating, ..the motto is healthy just come from us..)

Most of the informants is lack of knowledge about regulation aspect (SKB 4 ministries). Only informant from the UPTD can response more accurate about it. Here are the statement of the informant :

*SKB 4 menteri pernah dengar tapi lupa.....(staff of sub-district 1)*

(SKB..ever heard but forgotten -what that is)

*SKB 4 menteri itu termasuk UKS juga. Menteri kesehatan, menteri pendidikan, menteri agama, dalam negeri...pak camat sebagai ketuanya...(UPTD 4)*

#### **4 The Attitude of Steering Committe about implementation of UKS**

All of the informants agreed that UKS is very important in the school, as a matter of fact some

informant stated that UKS is a mandatory program. UKS can guarantee the health status of students and also to make easier implementing others health program in the school. UKS also can develop educational character in the students about healthy living and clean. Here are some informants's arguments :

*...sekolah adalah suatu komunitas, ketika kita melakukan screening, kita mengumpulkan itu lebih mudah, karena mereka udah terkumpul, kita nggak perlu mengumpulkan lagi. sekolah adalah lembaga pendidikan, untuk mendapat ilmu, ilmu-ilmu tentang kebersihan, perilaku hidup bersih, itu masuknya lewat pendidikan. Apalagi SD, itu sangat efektif (Head of health center 5)*  
(..school are community that it will be easier to collecting and screening them....)

*....oleh karena itu program UKS harus ada, karena UKS ini tidak hanya sekedar sifatnya memberitahukan tetapi juga diajarkan hidup sehat seperti apa untuk sebagai pola hidup keseharian anak-anak. Itu tujuan yang utama... (UPTD 4)*  
(..the main purpose of UKS is to teach students healthy lives)

*Wajib itu, tadi kan kesehatan anak, kebersihan, kalau sehat, bersih kan anak cerdas, kan diajari anak cuci tangan sebelum makan, kalau sehat anak jadi pintar. Wajib makanya wetiap sekolah harus ada papan UKS (UPTD 5)*  
(UKS is compulsory...)

*Pendidikan karakter itu (UKS), sesuai dengan mottonya sehat itu mulai dari saya termasuk lingkungannya. Biar anak sehat. (UPTD 2)*  
(UKS is one of character building..)

*bahwa memang wajib di sekolah untuk kesehatan anak, tapi di sekolah masih ada yang belum melaksanakan UKS (UPTD 1)*

## 5 The role and activeness of sterring committee

To measure the role and activeness of sterring committee, this research observe the coordination and meeting which are held in term of guiding and activating UKS in every school that become their responsibility. There are some various opinions related to the role and activeness of sterring committee from each components of sterring committee.

Most of the sub districts component stated that they lack of coordination about UKS due to the other program business. Routine coordination accross sector was conducted, but UKS wasn't talked too much. Some findings showed that the regulation in the sub district level about sterring committee of UKS haven't renewed yet. Most of them have the legal standing in the sub district level, but it was old version. Here are some options of informants :

*Ketika ada lomba UKS digerakne... kalo tidak ada ya diem, kalau ada lomba pramuka camat jadi pakaian pramuka, kalu tidak ada ya diem ya seperti itu. Karena apa yang jelek? dukungan dana tidak ada (Head of sub-district 3)*  
(when facing the UKS award there is coordination...budgeting is minimum)

*Kalau UKS ini momennya hanya rapat-rapat untuk pertemuan, itu aja, ..Seharusnya kan tidak. Lha memang karena kesibukan yang tadi. Kalau ada lomba-lomba aja, karena ya mungkin kekurangan pendamping ya. tapi sebetulnya sudah ada sekretariat tetap dengan susunan pengurus dan SK, tapi lama (staff of sub-district 1)*  
(..the meeting will be held when facing the UKS competition...)

*kalau koordinasi yang jelas kita rapat ya, rapat koordinasi meskipun molor-molor jamnya ... pembinaan terakhir dilakukan saat akan lomba UKS) kita sih sudah tidak bisa semua sekolah-sekolah lebih lanjut ya, karena sudah ada UPTD (staff of sub-district 5)*

*....sementara karena memang yang berperan lebih itu sekolahan, jadi kita hanya*

*memantau. Masalahnya gini, kan yg lebih tokoh itu kan sekolahan, sehingga sebetulnya kita iku kan Pembina, itu kan nanti kalo memang ada butuh apa. Berarti yang banyak berperan itu sekolahan, kita yang akan memfasilitasi. Kecuali kalau itu kegiatan memang dari pemkot. Itu kita yang punya inisiatif. Jadi kita kecamatan sifatnya pasiflah istilahnya (Head of sub-district 2)*  
(..the school should have more roles to facilitate the team..the sub-district office just monitored)

Some of Health center components prefer act as a mobilizer and coordinator of steering committee. But actually they argued that coordinator should be in the hand of head of sub district. Some of them act passively due to the financial barrier and consequently they only active when other components told them to do so. Here are some quotation of the findings :

*Sebetulnya saya itu di sini penggerak, tapi karena saya di bawah camat, maka saya ingin ini diadakan di kecamatan. ..Karena kalau saya yang mengundang yang datang itu cuma guru yang baru, saya berharap yang datang itu kepala sekolah, paling tidak orang yang bisa mengambil keputusan (Head of health center 5)*  
(...actually I am a motivator –to coordinate..I still hope that sub-district office that will be coordinate...)

*Itu (koordinasi) tidak jalan.....Menginisiasikan pertemuan itu kalau kita tidak punya dana, ya juga nggak bisa, misalnya puskesmas ini kan punya dana, dananya sudah plot untuk apa untuk apa dari DKK, jadi kita inisiasi, ya kalau dana tidak ada, ya kita tidak bisa (Head of health center 3)*  
(coordination wasn't running...it needs budget to initiate meeting, the budget of health center is limited...)

The argument from the UPTD components were different from the two other components previously. All of them stated that almost every month steering committee have coordination and meeting, at least once a year. Especially, the moment of UKS competition, the meeting was more intense. Here are some arguments from the informants :

*Jadi kita tiap bulan melakukan koordinasi di kecamatan, habis itu ada puskesmas, pokoknya tugas BK tiap bulan menyampaikan, terus pendidikan, UKS, ...setiap instansi menyampaikan. (tapi pembahasan UKS tiap bulan) kalo ada lomba (UPTD 1)*  
(so..each month we'll coordinate with health center, sub-district office, and educational office...)

*Bulan kemarin... setiap camat selalu mengundang untuk rapat berkala, dan selalu pak camat memberikan kesempatan untuk apa yang harus disampaikan. tidak hanya program dari UKS atau program-program yang berkaitan dengan program di lintas sektor (UPTD 4)*

*... ya setiap bulan diadakan pertemuan dengan lintas sektoral dari pihak kelurahan, kecamatan, puskesmas, ini tiap bulan kadang dua bulan kadang dilihat kalau ada kebutuhan.. kegiatan banyak kan nggak sempat mewakili.. seperti lomba kan setiap hari itu, kita kan nggak bisa lepas dari pembinaannya, administrasinya. Semakin ada lomba pertemuan semakin rutin karena dikejar waktu (UPTD 5)*

SKB 4 ministries (2003) about the maintaining and developing UKS stated that maintaining UKS is conducted hierarchy from the center level until sub district level which involve four ministries (education, religious, health and home affairs).

Leading sector is sector that have significant role in the UKS. There are different perception about leading sector in the sub district level. Some of informants consider the head of sub district is the leading sector, because he own the territory. But others argued that the leading sector is health center, because the content of UKS is mostly about health. And others also stated that the leading sector is the headmaster, because the UKS is in the school. Here are the arguments of the informants:



leading sector bu, ... Kalau sekolahnya dinas pendidikan, kalau kesehatannya kan dinas kesehatan semestinya yang paling berperan kan itu to bu, jadi kesehatan anak-anak itu di arahkan kemana yang tau masalah kesehatan itu kan dinas kesehatan .... Lah camat ini sebagai kewilayahan saja, ada penanggung jawab di wilayah (Head of sub-district 3)

gini lho.. kalau leading sector itu harusnya kan yang membawahi pimpinan yang ada di wilayah Bu.. jadi kayak camat. Nah sifatnya, makanya kayak yang saya selalu bilang tadi kalau leading sektornya kita, kita itu sifatnya koordinasi dengan jajaran lain kayak kesehatan, UPTD.. (staff of sub-district 5)  
(..leading sector should be who has the territory, like head of sub-district. He should be a lead sector..)

Saya kira lebih tepat (leading sector) dari sekolah. Jadi umpamanya kalau di setiap kecamatan ada semacam diknas, sekarang gabung.. memegang beberapa kecamatan. Jadi paling tidak ya dari sekolahan , jadi nanti sekolahan bergabung ... karena dia sendiri yang tau persis. Makanya kalau umpama ketua dari camat ya kurang pas, karena bagaimanapun juga suatu organisaasi itu kan dipimpin oleh orang yang benar-benar tau bidangnya (Head of sub-district 2)  
(...the appropriate –for leading sector- is school....)

(leading sector) tidak tahu..tapi (mestinya UPTD) Soalnya kalau diundang, UPTD yang mengundang otomatis kan lebih diperhatikan oleh guru/sekolahnya. Jadi peran UPTD sangat berpengaruh, misalnya kalau yang mengundang UPTD otomatis kepala sekolah atau guru UKS mengusahakan untuk hadir, nah nanti UPTD mengundang puskesmas sebetulnya bisa, (Head of health center 3)  
(don't know...but it should be UPTD..)

## 6 The achievement of TRIAS UKS

The success of maintaining and implementing UKS in every level of education can be seen by the implementation of TRIAS UKS as a core program of UKS which consist of health education activities, health services activities and maintaining health of school enviroment. Based on the criteria of TRIAS UKS, there are various opinion about it. Most of them agreed that the availability of UKS room is a general requirements to implement UKS. And also the availabilty of complete medicine is a qualification to implement UKS. Here are some opinions from the informants :

indikatornya sarana prasarana sampai sejauh mana kebulatan sekolah untuk menunjang program itu, program itu ditunjang sarana prasarana. Yang kedua agenda-agenda kegiatan-kegiatan anak untuk melaksanakan program UKS tersebut. Terus kami bisa kita lakukan instrumen-instrumen yang kita gunakan (Head of sub-district 2)  
(..one of indicators is infrastructure, the second are activities...)

harus ada khusus untuk UKS, karena apa ruang UKS itu apa ya menggambarkan bahasan apa itu walupun ada ruang UKS kalau disitu nggak ada apa itu kegiatan-kegiatan yang sifatnya riil.. percumah gitu lho (staff of sub-district 1)  
(there should be a room of UKS...)

Ya.. kebersihan lingkungannya terjaga, kantin sekolahnya. Itu anak-anak gak boleh jajan diluar. Itukan sudah ... sudah sekolahnya menjadi... kebersihan lingkungan (staff sub-district 5)

Ya, tapi maksudnya ya UKS nya tidak sempurna, tapi ada UKS nya maksudnya tadi.. kalau UKS nya sempurna kan ruangan harus ada. Ya, memang yang bagus ada ruangnya, misalnya bisa diistirahatkan tapi semua tergantung pada kondisi, kalo

*sekolahannya kecil nggak punya ruangan juga tidak bisa. Apalagi di Surabaya nggak semua sekolah bisa gitu (Head of health center 3)*

*Ya, tetep harus ada ruang UKS, terus memang kadang-kadang kita ngirim pelatihan pembina UKS, itu kita gilir supaya apa, walau pun dia atapnya asbes, dia tetap punya ruang UKS, dan kalau digubeng itu sudah punya semua, ya itu pokoknya sudah ada UKSnya (UPTD 1)*

## **7 Discussion**

Based on the center of health promotion (2007) UKS is activity to maintain and develop the healthy living lifestyle that conduct comprehensively through TRIAS UKS. The achievement of TRIAS UKS should be considered as a indicator of implementation UKS in a school. The result of the research showed that most of the informant lack of knowledge that TRIAS UKS is the core program of UKS. It can be seen from the respond of the respondent that the essential aspect from UKS is the infrastructure (room of UKS). Center of steering committer UKS stated that room of UKS is just one of items in the third TRIAS UKS, maintaining health of school enviroment .

Most of the informant supported the existance of UKS in the school. All informant agreed that UKS can make student healthier than before. This phenomena is in accordance with the purpose of UKS which is increasing the quality of education through increasing healthy behavior and also increasing health status of the students and creating supportive environments (Center of health promotion, 2007). Unfortunately some of the informant have lack of knowledge of UKS. Most of them isn't aware about the legal standing of UKS which is SKB 4 ministries. SKB 4 ministries is the legal standing of UKS in the school and consequently should involve all sector an all program in all level. Accross sector, because the steering committee come from 4 ministries. All program because of the program consist of all health issue and conducted not only about health service but also health education and create supportive environment in the school. The business and activities of steering committee with other responsibility out of UKS, is also as a barrier to conduct the coordination.

The results showed the need of socialization and effort to refresh the information about UKS in all components of steering committee in the sub district level. Coordination and meeting from all components of steering committee need to be rescheduled, not only when facing the competition, but the coordination should be done routinely based on the local meeting, for example the meeting of accross section in sub district level. The role of coordinator is in the sub district office by Head of sub-district (ministry of education, 2012). The component of sub district level also have responsibility to allocate financial for maintaining and implementing UKS in their teritorial authority.

## **8 Conclusion**

There are positive attitude in terms of supporting the implementation of UKS in the school, but this situation isn't followed by the good knowledge about the role of steering committee in sub district level about maintaining and developing UKS, and consequently the role and activeness hasn't optimally executed.

It is necessary to socialize, refresh and train for all components of steering committee in sub district level about role and function. Coordination and meeting from all components of steering committee need to be done, not only when facing the competition, but the coordination should be done to make sure that every sub district implement TRIAS UKS.

Evaluation to the component of steering committee and the role of them is another strategis issue so that the implementation of UKS would be better in the future.

## **Acknowledgement**

On behalf of the research team, we would like to thank to Faculty of Public Health, University of Airlangga, Surabaya, Indonesia, that have funded this research. Many thanks also given to all of the Steering Committee Team in Gubeng District, Mulyorejo District, Dukuh Pakis District, Lakarsantri District, and Semampir District, at Surabaya Municipality, East Java, Indonesia.

## **References**

Kemendikbud. (2012). *Pedoman Pembinaan dan Pengembangan Usaha Kesehatan Sekolah*, Jakarta.

Kementrian Pendidikan dan Kebudayaan. (2012). *Pedoman Pelaksanaan UKS di Sekolah*. Jakarta: Kemdikbud.

Limbu, Ribka. (2010). *Analisis Pelaksanaan Tiga Program Pokok Usaha Kesehatan Sekolah (TRIAS UKS) Tingkat Sekolah Dasar Kecamatan Blimbing Kota Malang*, Tesis, Program Magister IKM, FKM-UNAIR.

Maghfiroh, Apriliana L. (2011). *Kajian Faktor Penentu Pelaksanaan Tiga Program Pokok Usaha Kesehatan Sekolah (Trias UKS) di SDN Banyuanyar 1 dan SDN Rongtengah 2 Kecamatan Sampang Kabupaten Sampang*, Skripsi, FKM-UNAIR.

Moleong, J.Lexy. (2004). *Metodologi Penelitian Kualitatif (EdisiRevisi)*. Bandung: Remaja Rosdakarya

Permatasari, Dina. (2010). *Analisis Pelaksanaan Usaha Kesehatan Sekolah (UKS) di MTsN 1 Kota Blitar dan MTsN Kepanjenkidul Kota Blitar*, Skripsi, FKM-UNAIR.

Pusat Promosi Kesehatan. (2007). *Paduan Promosi Kesehatan di Sekolah*. Jakarta: Departemen Kesehatan RI.

Tim Pembina UKS Pusat. (2008). *Pedoman Pembinaan dan Pengembangan Usaha Kesehatan Sekolah*. Jakarta: Depdiknas

## Interactive Applications Preserve Culture and Heritage on Art of Wrapping Traditional Food: *Ketupat*

<sup>1</sup>Mhd Nor Osman, <sup>2</sup>Dr. Norhasandi Mat & <sup>3</sup>Mohd Khairul Azahari Abdul Rani

<sup>1</sup>FSSR UiTM Perak, Malaysia, [mhdno683@perak.uitm.edu.my](mailto:mhdno683@perak.uitm.edu.my), 60126585070

<sup>2</sup>FSPU UiTM Perak, Malaysia, [norhas095@perak.uitm.edu.my](mailto:norhas095@perak.uitm.edu.my), 60125163765

<sup>3</sup>FSSR UiTM Perak, Malaysia, [mohdk173@perak.uitm.edu.my](mailto:mohdk173@perak.uitm.edu.my), 60192385752

### Abstract

Most of the traditional food wrapping is made from various natural materials. *Ketupat* is one of the traditional food in Malaysia and in the Malay Archipelago. It is wrapped in coconut leaves called 'janur'. The origin of the *Ketupat* or *Kupat* is from Java, Indonesia. The migration of peoples in the Malay Archipelago has made the *Ketupat* with many similarities in terms of its use. The tradition of making the *Ketupat* started a few generations ago and became mandatory in certain ceremonies as a main meal. This activity is considered as a culture since it has been passed down through generations and has become a symbol to identify the community. *Ketupat* requires technical skills to weave its container, besides having its physical attractive characteristics and significant aesthetic values in shapes, lines, patterns and colors. *Ketupat* also has different symbolic meanings and has become beliefs in daily life. The effect of modern packaging has hit the tradition and threatens the art of weaving the *Ketupat*. Therefore, the development of interactive applications as a potential method to preserve the elements of culture values on Malay traditional food wrapping (*Ketupat*).

**Keywords:** *Ketupat*, art of wrapping, symbolic meaning, aesthetics, heritage, identity and culture value.

### 1 Introduction

Art activities among communities in the Malay Archipelago have been recognized worldwide as being very unique and interesting. In this community activity that contains the elements of art are produced through carving, weaving, carpentry, architecture and so on. This art has been fundamental to the culture of their lives for centuries. With this activity, the identity of the community is more visible and attractive to outsiders. According to Marzita Putih, et al, (2007), in the community, the arts are divided into two categories: Performing Arts (dance, song, stage performances such as *makyong*, *wayang kulit*, *ghazal*, tambourine, *kuda kepong*) and Visual Arts (sculpture, art architecture, decorative arts, crafts, and weaving).

Handicraft is a work of art created to be used, but composed by incorporating elements of art to form a beautiful and interesting outlook. Handicraft creation requires expertise and efficiency. According to Siti Zainon Ismail (1986), handicraft creation process requires the power of aesthetics in order to provide a beautiful and interesting design. Malay artwork has its own identity, which also shows a combination of various local elements and influences from abroad. Carving and weaving are part of the traditional art and can not be separated from the culture and way of life of the Malays. In fact, the art of weaving is part of the Malay life. Thus, art and culture as part of the life and identity of the country that need to be protected from the effects of globalization, A Ghafar Ahmad (2004). According to Abdullah A. Badawi (2007), arts, culture and heritage must be preserved from extinction. Noor Nikman Salleh (2009), said that the National Cultural Policy 1971, has outlined that national culture should be based on the culture of the Malays. Meanwhile, the *Akta Warisan Kebangsaan* (2005), suggests that the study or research of the documentation relating to the elements of culture is very important because it will rebuild a national identity so that it can be maintained, otherwise it will be lost in the course of modernization. Arts and crafts such as weaving mats or baskets have similarities in production processes such as in making rice cake (*ketupat*) which requires the skill to weave and fold, but only differ in terms of their usage. Therefore foods such as *ketupat* also can distinguish and identify the community of other races.

The influence of *moden Ketupat* wrapped in plastic material and changed the polar Malays settlements in Malaysia, will affect the younger generation to learn how to wrap traditional foods. The module, which incorporates multimedia elements and content knowledge associated with them, is developed to educate how to make *Ketupat*. An interactive content module that is developed will be a tool to teach the younger generation to learn traditional food wrap and will also provide knowledge about the art, its symbolic meaning, and values contained behind this practice as a culture that has been passed down for over a long period of time. If not preserved, the nation would lose its cultural identity.

### **1.1 The Issue**

Since the 1990s, the influence of *moden ketupat* wrapped in plastic material has taken place in the community. *Modern ketupat* is easier and faster to prepare. The Malay population now lives in the housing estates. There is no space to plant trees that can be used as traditional packaging materials such as banana trees or coconut trees. This will affect the younger generation to learn from their parents how to wrap traditional foods. This situation is expected to impact the traditional *ketupat* weaving especially to the next generation.

### **1.2 Limitation of the Study**

The study took a sample of the *Ketupat* as one of the traditional Malay cakes in the archipelago as a subject matter in this study. Therefore, the development of interactive content applications is only focused on this subject matter as a sample survey among traditional Malay cakes/*kuih*.

### **1.3 Significance of Study**

The study is to ascertain how many members in the family, especially the younger generation know how to wrap or still practice traditional food weaving such as *Ketupat*. It should be taught and the knowledge of weaving be transferred to the new generation. If not preserved, the nation would lose its cultural identity.

### **1.4 Objectives of the Research**

To investigate the factors that contribute to the loss of cultural values on Malay traditional food wrapping.

To propose the interactive applications content development of the Malay traditional food packaging.

### **1.5 Hypothesis**

There are a lot of elements on culture value in Malay traditional food packaging which exist and are applied in the daily life of the Malay society. However, the current Malay generation do not realize it and technology has replaced the traditional part of the Malay traditional food packaging. The proposed interactive method will have the potential to discover the lost of culture values in the Malay community.

## **2 Background**

### **2.1 Packaging History**

Around 10,000 years ago, packaging of foods was made from natural ingredients and they were applied and modified from animal skins, stems and leaves of trees. Packaging was generally divided into two different eras; modern and traditional packaging. Modern packaging usually include packaging for consumer goods. Gardon (2005), states that packaging has been translated as a socio-scientific discipline operating in the community to ensure the smooth delivery of goods to customers.

It occurs with the advent of technology, paper and printing industry in the 19th century. Bill, S (2007) provides that the packaging in pre-modernization era began in 1945. Based on Groth (2006), this is the beginning time line for packaging using modern materials. It continues until now when packaging technology is more innovative in terms of using of materials, functions, and design.

## 2.2 The Significance of Traditional Packaging

The way of life of a society or culture is becoming an identity to a nation. Usually it is simply and clearly identified by the color, dress, language, behavior, foods, customs and economic activities of a race. Abdullah A Badawi (2007), has reminded the people to defend the nation's cultural and artistic identity of Malaysia/Malay so as not to drown in the global cultural flows. He said, "Development in order to prosper the country can not run from maintaining the unique identity of the nation of this country is easily recognizable." Food can also distinguish a society of other people. It will be the identity of a community. The identity of a society will usually be inherited and has been the pride of the community, Marzita Puteh et al.,( 2007).

## 2.3 Japanese Traditional Food Packaging/Wrapping

History has shown that the Japanese are very famous for their traditional packaging using packing materials of natural elements and has the beauty of art. Some foods are packed in a durable manner and can be bought by tourists as souvenirs. According to Yuriko Saito (2007), the Japanese have a clear history and background on the philosophy of food packaging. The Japanese traditional packaging can be considered as a form of art because it features unique design in various forms such as baskets, boxes, wrapping paper, which are still used in everyday life. Hideyuki Oka (2008), explained that the Japanese use rice straw, bamboo, paper and leaves as wrapping materials. They provide *onigiri*, rice balls, wrapped in bamboo leaf. Bamboo fronds are substances of natural resources that have become popular packaging materials in Japan. It has become a symbol of freshness, because of the aroma of bamboo will seep into the food inside.



Natto



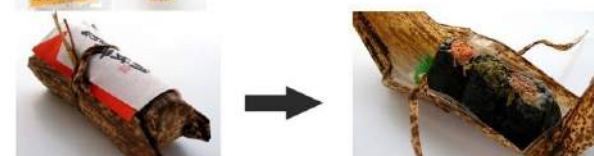
Asa-dango



Chimaki Sushi



Natto- straw



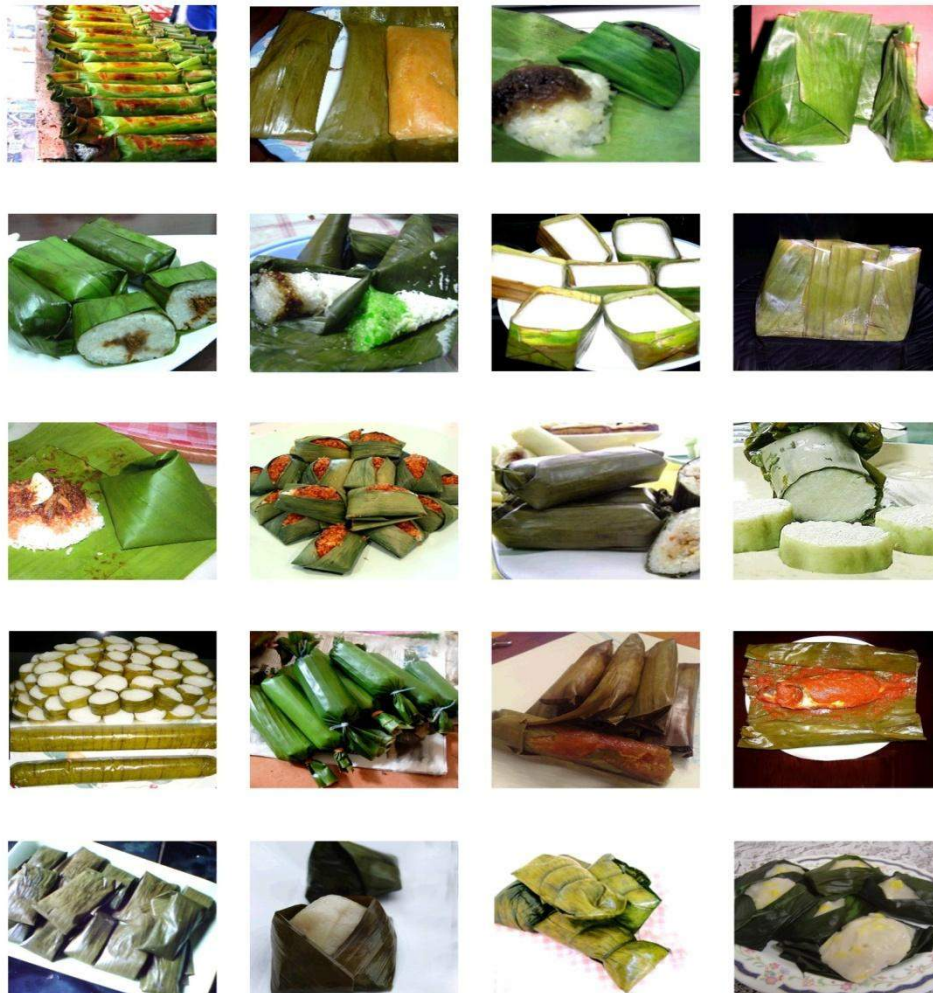
Onigiri

Traditional Japanese foods wrapped by various natural materials

## 2.4 Malay Traditional Food Packaging/Wrapping

The Malays as well as Japanese society is famous for their cuisine, especially cakes (*kuih*) or food cooked and served by using a wrapper of natural materials that can be found around the house. (Retrieved from: AbsoluteAstronomy.com, 2009).

The Malays are also rich in various kinds of traditional packaging. According to Nik Hassan Suhaimi (2005), the Malays in Peninsular Malaysia is said to be derived from a variety of ethnic hill in the archipelago. He divided the Malays into some ethnic groups factions, (for example: *Aceh, Bugis, Minangkabau, Minang, Banjar, Pattani* or *Java*). Therefore, each ethnic group has its own culinary arts tradition and the identity of privileges for each group.



Various traditional Malay cakes (*kuih*) wrapped in banana leaves



The interesting aspect about the Malay *kuih* in the archipelago is in the types of leaves which are used for wrapping food. The leaves are: *Lepat* wrapped in banana leaves, *ketupat palas* wrapped in palas leaves, *dodol* and *lempok* wrapped with *upeh pinang*, where *tapai* also can be wrapped either with *baharu* leaves, *ketapang* leaves, *keladi* leaves, *banana* leaves or rubber tree leaves. *Kuih tepung pelita* can be wrapped using *pandan* leaves or banana leaves, while *ketupat sate*, *otak-otak* and *belebat* are packaged in different ways using coconut leaves.

However, among these materials, banana leaves is very famous and most widely used as wrapping for some Malay foods and cakes. For example, *pulut panggang*, *tepung bungkus*, *lepat*, *kuih koci*, *tepung pelita*, *tapai*, *nasi lemak*, use banana leaves as a wrapper. Uniquely, each type of *kuih* has a distinctive way of wrapping methods and techniques, even in using materials from the same wrapping material which is banana leaves.

However, more unique is the *Ketupat* which uses coconut leaves and have to go through the process of weaving to create a cone or sheath. This uniqueness requires skills that not everyone has, especially this generation.

### 3 Statements of Problem

#### 3.1 The Influence of Modern Packaging

Since the 1990s, the influence of *moden Ketupat* wrapped in plastic material has taken in the community. *Modern Ketupat* is easier and faster to prepare. This situation is expected to impact traditional *ketupat* weaving especially to the next generation. The same applies to *Kuih Tapai*, *Nasi Lemak* and *Kuih Tepung Pelita*, which are now wrapped with plastic and PVC containers.

Nowadays, plastic packaging has taken over the functions of traditional packaging. With plastic packaging, the aroma and natural smell of packaging materials are missing. There is no longer the taste of the original fragrance of food packaging materials. If the situation continues, people will lose their skills on how to wrap these traditional foods.



Plastic packagings took over traditional packaging.



### **3.2 The Problem of Waste Disposal**

The use of plastic materials is not easy to rot or decompose, it will contribute to environmental degradation. Waste of plastic material is not environmentally friendly and it takes a long time to decompose and disintegrate. As a result, Malaysia is burdened by the cost of managing solid waste disposal and if not managed well, this will cause environmental pollution.

### **3.3 Chemicals / Pesticides**

Plastic materials used for packaging foods can cause adverse effects to the human body. According to the Consumers Association of Penang (CAP) SM Mohamed Idris (2006), the results of a study by the Institute of Materials Science and Technology, Princeton, USA, revealed that plastic material when at a level of heat will secrete polyethylene (VOC), a type of chemical that can destroy the human hormone that also causes cancer. Similar results were also obtained by Rahmat Awang (2006), from a survey conducted by several scientists from the National Poison Centre (*Pusat Racun Negara*), Universiti Sains Malaysia, Pulau Pinang, Malaysia.

### **3.4 Population and Development**

Rapid development of the Malaysian economic over the last fifty years has changed the polar settlements in Malaysia. Most of the Malay population now live in housing estates in suburbs and cities, Wan Hashim Wan Teh (1998). These areas do not have enough space to plant trees that can be used as traditional packaging materials such as banana trees or coconut trees. It is different with people who are still living in villages where traditional packaging materials can be found surroundings their homes.

Consequently, those who live in housing estates have limited opportunities to cook and they only choose foods that do not require such packaging materials. To get traditional packaging materials, they have to go to the market. This situation makes them choose to cook foods that do not use wrapping from leaves. Over time, the younger generation will not learn from their parents how to wrap traditional food. With this situation, this tradition of weaving will not be passed to the new generation, it will be lost to modernity, Hashim Hj. Musa (2005), Hasanah (2008).

## **4 Multimedia Interactive and Applications**

Multimedia is one of the most fascinating and fastest growing areas in the field of information technology. Multimedia is the blending of text, pictures, animation, movies and sound, video, audio, computer programming and graphic arts with the latest in technology including: CD-Rom, DVD, web sites and interactive kiosks. It offers an eye-catching and memorable presentation of the products or ideas.

Multimedia can be used for entertainment, corporate presentations, education, training, simulations, digital publications, museum exhibits and so much more. With the advent of multimedia authoring applications such as Macromedia Flash, Macromedia Shockwave and Macromedia Director, amongst a host of other equally enchanting applications, the multimedia end product is only limited by our imagination. (Retrieved from: Aviddesign.com, 2004)

The design and development of the proposed module is based on the concept from many blogs and tutorial videos. The researcher has gone through other similar modules but this module was very close with what the researcher has planed to do at the early stage of study. After studying this module and based on the early planning and observation, the researcher compiled other relevant sources to determine the type of application to be developed. For this purpose, the information is also gathered from informal interviews with the experts in the field and a questionnaire was design at the preliminary stage of survey.

The development process of the module is divided into five main categories :

- Conceptual idea.
- Designing on visual and scripting.
- Prototype of visual.
- Production and preparation of the contents and design elements.
- Testing the product.

## 5 The Contents of Interactive Module Development

The study is to ascertain how many people in the a family, especially the younger generation who know how to wrap or still practice traditional food wrapping such as *Ketupat*. An interactive content module that is developed will be a tool to teach the younger generation to learn traditional food wrap and will also provide knowledge about the art, symbolic meaning, and values contained behind this practice as a culture that has been passed down. The study took a sample of the *Ketupat* as one of the traditional Malay cakes in the archipelago as a subject matter in this study. Therefore, the development of interactive content applications is only focused on this as a sample survey among traditional Malay cakes/*kuih*.



Proposed Interactive Module: Integrated contents knowledge for *Ketupat*

The contents of the module is divided into five main points :

- History of *ketupat*.
- How to weave the *ketupat*
- Types of *ketupat*

- The symbolic meanings
- The elements of art

## 5.1 The History of Ketupat

*Ketupat* is a traditional food made from rice and wrapped in coconut leaves, known as *Janur*. *Ketupat*, is very popular on the eve of Hari Raya Aidil Fitri or Hari Raya Aidil Adha. The tradition of making the *ketupat* started when Islam first came to Java. (Retrieved from: www.aCeh Forum Community)

### 5.1.1 The Origin of *Ketupat*

In history, the Sunan Kalijaga is the first to introduce *ketupat* in the Java community. He civilize to make *ketupat* twice referred to as *Bakda* i.e during the celebration of Eid al-Fitr is called "Bakda Lebaran" and "Bakda Kupat" is one week after the day of Eid (after fasting six days in Shawwal). On the day called *Bakda Kupat*, in Java almost every house weaves the *ketupat*. After they have finished cooking, *kupat* (*ketupat*) is sent to the home of relatives, starting with the oldest first, as a symbol of unity. (Retrieved from: www.aCeh Forum Community)

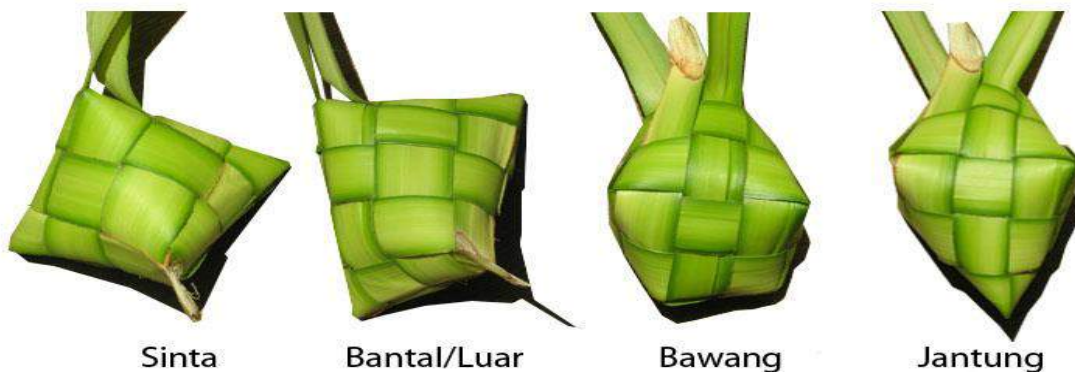
According to Agus Wibowo (2008), the tradition of making *ketupat* was started by KGPAA Mangkunegara I, who was known as the *Pangeran Sambernyawa*. At that time, after the Eid prayer, a meeting was held between the King and the *penggawa* (chief of districts) and the soldiers simultaneously in the *balai istana*. All *penggawa* and soldiers, with the orderly together perform a *sungkem* (a way to seek for apologies) to the king and queen.

The history of making *ketupat*, according to M Yusril Anwar Al Jafary (2008), is said to be derived from the traditions of the community *Wali Songo*, it was an attempt to incorporate Islamic elements in the tradition of making the *ketupat*. This is because in ancient times, the Javanese always uses erratic symbols. Finally the *Wali Songo* took advantage of the ways in which the tradition of making the *ketupat* and ended up using the symbol of the *janur*, the yellow coconut leaves.

### 5.1.2 Ketupat in the Malay Archipelago

*Ketupat* has traditionally been made and eaten in the Malay Archipelago when celebrating Eid al-Fitr and Eid al-Adha. The festival is incomplete without the *ketupat*. Practically every home prepare this delicacy. As the entire geography of the islands of Malay Archipelago is planted with coconut trees, it is very easy to get the leaves 'janur' the young leaves, which are used as cladding for woven the *ketupat*.

The nature of the Malay Archipelago, there are similarities in the history of the tradition in making the *ketupat*. In Malaysia, Singapore, Brunei, Sabah and Sarawak and most of the Indonesian archipelago it was known as 'ketupat'. In some places in Indonesia, *ketupat* is referred to as 'kupas' or 'ketupek' mainly by tribal Java. In Indonesia, *ketupat* is sometimes boiled with coconut milk for added flavor.



### Different types of *ketupat* woven using young coconut leaves

In the Philippines, the Moros in Kapampangan, called *ketupat* as 'Patupat', 'Puso' in the Cebuano area and 'Ta'mu' in the Tausug. Leaf (young coconut leaf) are named *Arecaceae*.

In Malaysia, *ketupat* is usually divided into two categories, namely *ketupat nasi* (normal rice) and *ketupat pulut* (sticky rice). *Ketupat* rice is rectangular shape using rice as its contents are wrapped with coconut leaf, while *ketupat pulut* (use sticky rice) a diamond-shaped, wrapped with *palas* leaves, usually referred as *ketupat palas*.

## 5.2 Type of *Ketupat*

Generally, *ketupat* is a typical of Southeast Asian dish made from rice. Rice is inserted into the woven coconut leaves and boiled or steamed to cook. *Ketupat* is most prevalent when it comes to the festive season, when Muslims celebrate the end of the fasting month. *Ketupat* is also often served with *satay*. Among the people in Java, *ketupat* is often hung over the entrance to the house as a symbol of saving things. In Bali, *ketupat* is often presented as serving in a religious ceremony. Among the types of *ketupat* are:

### 5.2.1 *Ketupek Katan Kapau*

This *Ketupat Katan* is small sized and cooked with coconut milk in a bamboo cylinder. During cooking, coconut milk is left to concentrate once and blended into the *ketupat*. *Ketupat katan* can be eaten during afternoon tea, but can also be eaten with spicy dishes, such as curry or stew (*rendang*).

### 5.2.2 *Ketupat Glabed*

*Kupat Glabed* is very famous in Tegal, Indonesia. *Kupat Glabed* is a *ketupat* that is eaten with thick gravy yellow. *Ketupat* is cut into pieces, put inside it some fried *tempeh*, and smothered with gravy *glabed*. For more spice *sambal* be added.. On it cracker noodles made from cassava flour and sprinkled with fried onions. As a side dishe, *Kupat Glabed* is always eaten with *satay* chicken or shellfish.

### 5.2.3 *Ketupat Betawi (Bebanci)*

The most typical dishe and unique feature is the *ketupat bebanci* by the Betawi community. This *ketupat* is not made for sale even though it is very unique and delicious. As the name implies, *ketupat Bebanci* is cooked with the main elements of the *ketupat*. This *ketupat* is eaten with coconut milk which contains buffalo meat.

### 5.2.4 *Ketupat Blegong (tegal)*

*Kupat Blengong* (*Kupat Glabed* eaten with *Blengong* meat, is the result of interbreeding species of ducks and geese).

### 5.2.5 *Ketupat Bongko (tegal)*

*Kupat Bongko* is *ketupat* with vegetable *tempeh* that has been acidified.

### 5.2.6 *Ketupat Cabuk Rambak (solo)*

*Cabuk Rambak* is rice *ketupat* sliced lemon-lime, and sprinkled with sesame sauce mixed with a little grated coconut. Sauces taste very special indeed. This dish is served with rice crackers called *kara*.

### 5.2.7 *Ketupat/lontong Sayur*

Usually vegetables *lontong sayur* is served with thick gravy, add in some glass noodles (*su'un*), boiled eggs and sprinkled with fried onions.

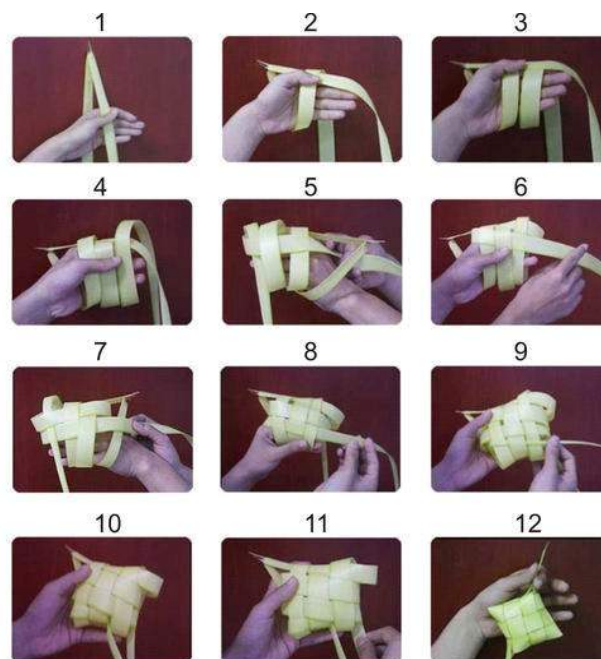
### 5.3 How to Wave Ketupat

To make the *ketupat*, especially weaving techniques, requires creativity and skill of its own in order to produce woven cladding of 'janur' which has artistic value. Not everyone knows how to make *ketupat* and to be able to make it, one has to learn to weave.

#### 5.3.1 Materials to Make

- *Janur* (coconut leaves); which has been cleaned and select the bright yellow color.
- Cutting tools; to separate the coconut leaf from the stems.

#### 5.3.2 General Way to Make Ketupat



(Retrieved from: arjunafirdausi.blogspot)

- Choose good quality rice, wash up clean. Soak the rice for 3 hours with clean water. Drain, mix a little *kapur makan*. If the rice is unclean, the *ketupat* will be perishable.
- Fill cladding *ketupat* with rice until 3/4 full.
- When boiled, the diamond must be submerged in boiling water altogether. If water reduces boiling water is added. The duration for cooking *ketupat* is between 4 to 6 hours.
- After cooking, lift the *ketupat* and hang it up to dry.

### 5.4 Art Elements in Ketupat

### 5.4.1 The Meaning of Art

Art can also be interpreted as meaning or sense abilities to create a painting, sculpture, calligraphy and it was so beautiful to look at. According to Oxford Dictionary (1989), Art is: *The production of something beautiful: skill or ability in such work. Works such as paintings or sculptures produced by skills.*

Ibn. Khaldun states, "art is truth, beauty and goodness in which it contains the characteristics of aesthetics, ethics and logic." Aristotle, believes that art is an imitation or replication process of the world, life, people, meaning the display or new ideas on an existing design. Plato also believes that art is an imitation of nature (Art's imitation natural). Meanwhile, Schopenhauer thinks that art is an attempt to create new forms of fun, everyone loves the art of music, although music is the most abstract art.

### 5.4.2 Elements of Art

To make *ketupat*, especially the case, needs creative power to produce cladding woven coconut that has artistic value. Indeed, Not everyone is good at making the *ketupat* and to be able to create there is a need to learn how to weave. Viewed in terms of its shape, the *ketupat* is said to have characteristics that make up the perfection of its art and, thus the value of the *ketupat* works into the art and culture of a society.

From the creativity of someone weaving *janur* for cladding made of *ketupat*, it is known names *ketupat* include: *ketupat raya*, *ketupat sate*, *ketupat jantung*, *ketupat berlian (diamond)*, *ketupat bawang*, *ketupat duduk*, *ketupat bantal*, *ketupat sinta*, *ketupat jago*, *ketupat luwar*, *ketupat sido lungguh*, *ketupat khodok*, *ketupat bata* and others. It is not clear the origin of the name of *ketupat*, but usually these names connected with the shape of the *ketupat*.

The basic elements of art are translate by the results during the process weaving a *ketupat* as the objects of art, which are; form, shape, finish line, texture, space and color.

#### 5.4.2.1 The Form/Shape (*bentuk*)

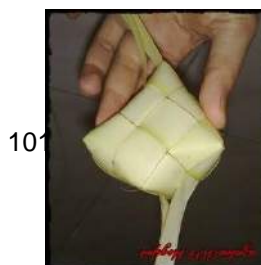
Form within the meaning of the language, it means waking up (shape) or physical form (form). Build (shape) is a kind of plain shape, as seen by the eye, just to mention it is round, square, ornamental, irregular and so on. Physical form is the kind that looks and feels because of the element of (value) of these objects, such as a closet. Chest exist in a space and is not just a rectangular box, but has its value and function. Three-dimensional shape bounded by space that surrounds and forms that include pyramids, prisms, cones, cone, and cylinder.

Irregular shape cubes and square, either in two or three dimensions affect static, stable, and formal. When the shape loomed up, its seems so great and stable.



*Ketupat Bantal*

Round or spherical shape of the curve affects dynamic and moving (movement).





### *Ketupat Bawang*

Tapered triangular shape affects active, energetic, sharp, and pointing direction.



*Ketupat Intan/jantung*

(Retrieved from: shvoong.com)

#### **5.4.2.2 The Lines (*garisan*)**

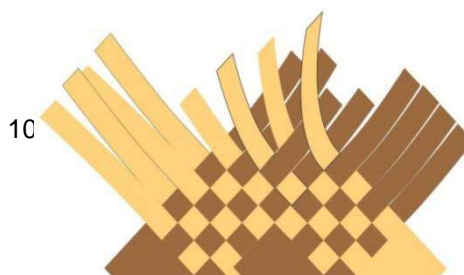
These few lines of dots that are contiguous or which have a certain distance. Lines play a very important role in creating the appearance, shape, fabric, movements, tones and pattern. Lines also play an important role in showing one's feelings in a work.



Lines have elongated nature and have a certain direction. Although it has an element of thickness, the nature of the most prominent is the length dimension. Of shape, line distinguished by straight lines, curved lines and broken lines (zig zag). Ruler also has a specific character depending on the media, techniques, and place making.

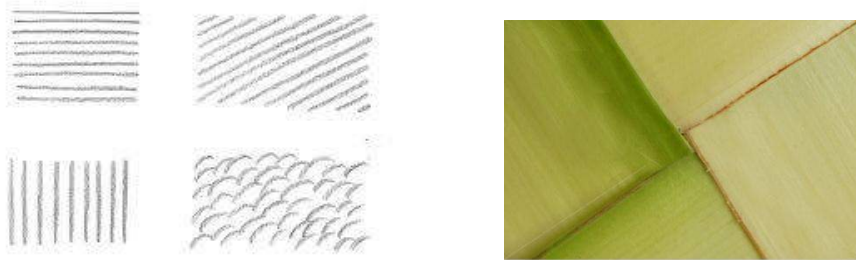
#### **5.4.2.3 The Interwoven (*jalinan*)**

Interwoven intends effects found in an object's surface. Interwoven is divided into two sections: Interwoven touch and looks.



#### 5.4.2.4 The Texture (*tekstur*)

The texture in art means karakter, nature, or the value of a surface material that looks and or touched. Usually in the form of a smooth texture, rough, bumpy, slippery and so on. Of course the texture of wood, stone, ceramic, and paper have differing values.

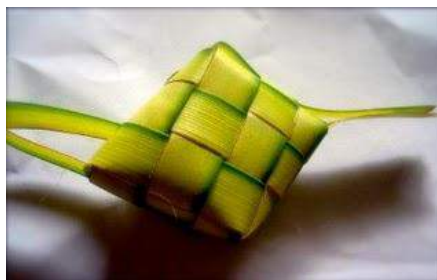


There are two types of texture, namely:

- i.. Realistic Texture, where the surface of an object when seen and touched have the same characteristics.
- ii. Virtual Texture, the surface of an object that looks similar to the characteristics of the object when touched.

#### 5.4.2.5 The Colors (*warna*)

Color play an important role in creating atmosphere. Various artists can show one's feelings while using the types of color in his art work.



According to Chai Wuang Shen (2010), color is the most important element in the visual arts field. Colors are divided into:

- The basic colors - red, blue and yellow



- Secondary colors - mix two shades of basic colors into the third color.
- Tertiary colors - a mix of revenue to the three colors.
- Monochrome color - the color is mixed with white and black to dark color desired control.
- Natural color - black and white, the result of the effect of light and silhouette.

## 5.5 Symbolic Meaning

Despite the tradition of weaving coconut leaves, there are philosophies contained therein. According to M Yusril Anwar Al Jafary (2008), a *ketupat* or a traditional Javanese 'Kupatan' is not just a traditional day of Eid by serving *ketupat*, but has many profound meanings behind its use for various occasions in the life of society, ranging from methods and materials to make it, to how to eat it. It is the symbolic meaning of these various aspects.

### 5.5.1 Meaning from the Name

*Ketupat* in the Java language is called *Kupat*, that is, the tradition of the *ketupat*-consuming outside (after) the day of Eid, which is usually called *Ketupat Raya*, or referred to as a outside *Kupat* tradition. *Kupat* comes from *Pat* or *Lepat* (offense) and "outside" which means outside, or freed or released, with the hope that people who eat a *ketupat* means they are independent and free from offense. With the public expected to forgive sins of everyone with the symbolism of *ketupat* consuming.

From one source, the *ketupat* from *kerotoboso* (language abbreviation) of said *Ngaku Lepat* that means admitting mistakes. The tradition of making and consuming *ketupat* is expected to make us admit our mistakes so that helps us to forgive the mistakes of others as well. This means, there will be another sin dissolved.

*Ketupat* or *Kupat* in Java language as "Java dhosok" also means "ngaku lepat". In this case contains the order that someone immediately admits his guilt when making mistakes. The action "ngaku lepat" has become a habit or tradition on the first day of Shawwal, i.e by providing *ketupat* and the other dishes in the homes on the day of Eid, so-called *ketupat lebaran*. All this shows the same symbol: confession to the Almighty God and to their fellow human beings.

*Ketupat* from the language of *Sunda* is also called as *kupat*, means that someone who doesn't like to *ngupat* (gossip), which is bad-mouthing other people, because this would arouse the anger of others. In this sense one can be reminded to refrain from actions that *ngupat*.

Along with the above meanings and the dates of Shawwal, *Kupat* is "Java dhosok" from "laku papat" (four measures). The culture of serving *ketupat* on 1st of Shawwal gives the meaning that humans have to take 4 actions which: *lebaran*, *luberan*, *leburan* and *laburan*.

Eid, means "completion". It is intended that the first day of Shawwal is the sign of the completion of fasting, then 1st of Shawwal is commonly referred to as the holiday. On the day of Eid Muslims are required to eat, and not to fast anymore.

*Luburan*, means overflow, like water from a jar, so abundant contents are spilled over. It is a symbol that gives the order to give some of one's wealth to the poor, that is, charity with such sincerity spills / overflow water from the jar. This can be seen in the Islamic tradition, that is, giving *sedekah* or *zakat fitrah* on 1st of Shawwal.

*Leburan*, in line with the meaning of *ngaku "lepat"*, i.e confess and apologize to each other in Javanese culture, the implementation of *Leburan* on 1st Shawwal with speeches of apology from a lower social status person to a person of higher social status, or from child to parent, that is, greeting "mugi segeda lebur ing dinten menika". It means that all mistakes before this can be removed and excused on that day.

*Laburan*, *labur* (whitewash) is material to whiten the walls. In this case, as a symbol that gives meaning to take care of yourself physically and spiritually. So after implementing the *leburan* (forgiving each other), Muslims are advised to keep a good attitude and actions, to reflect good manners too.

Thus the meaning contained in the *ketupat* served where anyone who eats its considers about the meaning and the message contained in it

### 5.5.2 Meaning from the Form/Shape

*Ketupat* shape represents perfection. This relates to the victory of Muslims after a month of fasting and the victory against lust.

The angular shape of the *ketupat* can be defined by the Java community as the embodiment of *kiblat papat limo pancer*. Meaning *kiblat papat limo pancer* as the balance of nature: 4 diagonal directions, namely, East, South, West, and North. However, all these directions are around a center (*kiblat*). When one of them is missing, the balance of nature will be lost. Such was the man in his/her life, he/she goes in any direction, but not to forget God Almighty.

*Kiblat papat limo pancer* can also be defined as 4 types of human passions in the tradition of: *amarah*, *alumahan*, *supiah*, dan *mutmainah*. Anger is an emotional desire, lust *alumahan* to satisfy hunger, lust *supiah* is to have something beautiful or good, and the lust for *mutmainah* force yourself. The four passions are four things that we need to maintain during fasting, so by eating *ketupat* symbolizes that we have been able to resist temptations.

### 5.5.3 Meaning from the Making Process

*Ketupat* is a food with rice contents in it, packed using *janur* or coconut leaves which are yellowish in color. The tradition began with the weaving the packaging or casing. The casing is made usually before Eid, and made usually by women. Making a *ketupat* in a group is enliven on the Day of Eid, and demonstrate familiarity among the community. One way to cook rice cake is by boiling it in coconut milk, or, if the *ketupat* is boiled in plain water, it will be served with food which is cooked with coconut milk. This makes the privilege of the *ketupat*, as a special food, as well signifies the relationship between communities and the social interaction between families and residents during the process of preparing the *ketupat*.

### 5.5.4 Meaning from the Yellow *Janur* (Young Coconut Leaves)

*Janur* a name in Javanese *dhosok* culture (true nur), short for "Jatining nur" or be construed as a voice of conscience (a pure heart). The yellow *janur* or coconut leaves are a symbol of refused reinforcements. At the Kraton Surakarta, is one of the accessories required to be used, in the form of long yellow cloth. The fabric is called *Samir*. *Samir* is a repellent reinforcements, so the *janur* is the symbol of the *samir*.

### 5.5.5 Meaning from Rice

Rice as a symbol of prosperity, rice is considered as a prayer that we will all be given the abundance of prosperity after fasting. Rice proved to be a symbol of a lustful world, so that the *ketupat* symbol of lustful the world that may be covered by conscience (the intent of the leaf). This means every human being has desires, but desires it may be controlled or restrained by conscience. In this vein, if a man can not control the desires of his world, then someone will reveal the nature of the ego and the actions it does reflect the sheer lust. This means that the light of God shining reduced from the human's heart. One should be able to fight his lust so as to achieve self-control.

### 5.5.6 Meaning from Coconut Milk

Coconut milk, or in the Java language is *santen*, synonymous with the sound of the word *ngapunten* which means apologize. A famous poem that mentions the *ketupat* and coconut milk is:

Mangan kupat nganggo santen.  
Menawi lepat, nyuwun pangapunten.  
(Eating *ketupat* with coconut milk.  
If there any mistake please forgive.)

### 5.5.7 Meaning from Weaving Process

Two strands of coconut (young coconut leaves) woven into a *ketupat* symbolizes the bond of human life married couple, of two souls into one. Two strands of woven coconut weaved painstakingly to become casing of *ketupat*. This situation is akin to how difficult it is to maintain harmony of households. *Ketupat* is not difficult if you want to eat just by taking a knife and then cut it and can continue to eat. This situation is akin to human life that is hard to be married but if you want a divorce is very simple as splitting the *ketupat*. *Ketupat* also symbolizes various human afflictions, which are visible from the complexity of weaving the *ketupat* casing.

### 5.5.8 Meaning from Colors

*Ketupat* reflects the cleanliness and purity of heart after praying for forgiveness, that is translated through the white color of the rice as well as the color white coconut milk. Meanwhile the yellowish green leaf color gives meaning of freshness, serenity and gentleness of nature created by God.

### 5.5.9 Meaning from the Way it is Serves

Aside from eating a *ketupat* in the morning of Eid with family, there *punjungan* event, that is, delivering of ready-cooked meals at night or early morning to your relatives' houses, starting with the oldest brother's house first. This gives meaning in the Java community, indigenous *punjungan* which means to give respect and appreciation to older relatives and this makes a family relationship.

### 5.5.10 Meaning from Customs and Beliefs

*Ketupat* is also used as a supplement in the human life cycle, for example, for the purpose of four months old baby in the womb. The types of *ketupat* used in this ceremony to celebrate are *ketupat jago*, *ketupat sinta*, *ketupat sido lungguh* and *ketupat luwar* the following meanings:

Four types of *Ketupat* are used, in line with the pregnancy period of four months.

***Ketupat Jago*** - Contains the intention that the baby to be born a male is to be a champion (hero), that is, have the character of a knight and have high status.

***Ketupat Sinta*** - *Sinta* is a symbol of a beautiful woman and virtuous. In this connection, if child born is a female, she will have beauty and be virtuous.

***Ketupat Sido Lungguh*** - There is a belief that the four-month pregnancy Almighty God breathed spirit into the baby, thus the baby of four months gestation in the womb is perfect outwardly and inwardly, meaning a human who has been given body and soul elements by God Almighty .

***Ketupat Luwar*** - *Ketupat Luwar* means will be given release. This symbol gives the message that the baby can be born easily and safely. This symbol also gives the message "ngeluwari ujar", ie fulfilled the expectation. This means the pregnancy is the achievement of the expectations of parents who want a child through the process of pregnancy.

(Retrieved from: Tim Koordinasi Siaran Direktorat Jenderal Kebudayaan,1995)

## 6 Conclusion

The findings have shown that only 20% of households who know how to weave *ketupat*. This means that in a family with a total of 6 family members, on the average only 2 persons know how to weave *ketupat*. Among parents who know how to weave *ketupat*, is only 10% of them. The remaining 10% is among the children who represent the younger generation. The study also shows about 3% of the Malay community know about the symbolic meaning and philosophy behind the art of weaving as a traditional food cake. However, not all practiced these symbols in their daily life as had been practiced by previous generations.

This situation gives the impression that the importance of research done on the *ketupat* as traditional food philosophy, as a cultural practice can create something of artistic value, and also as a symbol of cultural expressions that have meaning and good practice. It turned out so far, that the public needs to be cultivated again so that they understand the meaning behind cultural activities and social around them that have a meaning that can be used in everyday life. The *ketupat* should be promoted in an initiative to improve the country's cultural heritage so that it becomes part of the national culture.

Interactive application that has been developed is able to prevent the situation. The study found that 70% of respondents already know how to weave *ketupat* based on this interactive materials which was developed. A total of 96% also have an understanding of the contents of this interactive materials. This indicates that the application module has the potential to help people understand the philosophy behind the tradition of making *ketupat*. It is important to prevent the tradition from being lost in the flow of modernization.

## References

- A.Ghafar Ahmad (2004), *Urban Conservation in Malaysia: Safeguarding Cultural Heritage for Tourism Development*. Paper Presented at Seminar Budaya, Pemuliharaan dan Warisan di Malaysia. Fakulti Ecologi Malaysia, Universiti Putra Malaysia, 30 September 2004.
- Abdullah A Badawi (2007), *Pertahan budaya, kesenian bangsa*, Berita Harian, Malaysia, 10 April 2007, pg. 2].
- Agus Wibowo (2008), *Aneka Ragam Khasanah Budaya Nusantara*, Sinar Harapan Edisi Selasa, 30 September 2008, Jakarta.
- Agus Wibowo (2008), *Kesalehan Kultural Tradisi Syawalan*, Harian Sinar Harapan Edisi Selasa, 30 September 2008, Jakarta.
- Akta Warisan Kebangsaan (2005) (Akta 645), Jabatan Warisan Negara, Kementerian Kebudayaan, Kesenian, dan Warisan (KeKKWA). Kuala Lumpur.
- Bill, S. (2007), *Packaging Design*, Laurence King Publishing, UK
- Chai Wuang Shen (2010), *Unsur-unsur Seni*, <http://chaiwuangshen.weebly.com/1/post/2010/11/unsur-unsur-seni.html> (11/09/2010).
- Groth, C. (2006), *Exploring Package Design - The Art and Techniques of Designing Exceptional Packaging*, Thomson Delmar Learning, Canada
- Gordon, L. R. (2005), *Food Packaging: Principles and Practice*, Marcel Dekker Inc, New York, USA.
- Hasanah (Dr.) (2008), *Anyam Ketupat: Seni Kraftangan yang dilupakan*, [www.Dr Hasanah .com](http://www.DrHasanah.com)
- Hashim Hj. Musa (2005), *Pemeriksaan Tamadun Melayu Malaysia Menghadapi Globalisasi Barat*, Penerbit Universiti Malaya, Kuala Lumpur.
- Hideyuki Oka (2008), *How to Wrap Five Eggs: Traditional Japanese Packaging*, Weatherhill, Boston.
- M Yusril Anwar Al Jafary (2008) *Pengaruh Tradisi Kupatan(Hari Raya Ketupat) terhadap sikap keagamaan Masyarakat Duku Klumosari*, Fakulti Agama Islam, Universiti Muhammadiyah Surakarta, Indonesia.
- Marzita Puteh, Sadiah Baharom, Jamilah Omar (2007), *Pemikiran Saintifik dan Matematik dalam kraf Anyaman Buluh Melayu Tradisional: Satu Kajian Kes*, Jurnal Peradaban Melayu, Jilid 5, Tahun 2007, Universiti Pendidikan Sultan Idris, Tg. Malam.

- Nik Hassan Suhaimi Nik Abd Rahman (2005), *Aspek-aspek Tamadun Melayu: Perkembangan dan Perubahan*, (Seminar Warisan Seni Bangsa: Bicara Warisan Khazanah Jiwa), Upena, UiTM Shah Alam.
- Noor Nikman Salleh (2009). *Bab 2: Impak Globalisasi, Seni dan Kebudayaan*, Universiti Teknologi Malaysia.
- Rahmat Awang (Prof. Madya) (2006), *Bahaya Bahan Kimia Dalam Pembungkusan Plastik*, Pusat Racun Negara, USM.
- S. M. Mohamed Idris (2006), *Ketupat Segera Dalam Plastik boleh Akibat Kanser*, Utusan Malaysia, 2 November 2007, pg. 9].
- Siti Zainon Ismail (1986), *Rekabentuk Kraftangan Melayu Tradisi*, Dewan Bahasa dan Pustaka, Kuala Lumpur.
- The Oxford Paperback Dictionary, 1989 :40
- Wan Hashim Wan Teh (1998), *Nilai Budaya Masyarakat Desa*, Kajian Etnografi di Wang Kelian, Perlis, DBP.
- Yuriko Saito (2007), *Everyday Aesthetics*, Oxford University, NY
- [http:// :www.Aviddesign.com](http://www.Aviddesign.com), 2004
- <http://arjunafirdausi.blogspot.com/2012/08/tutorial-membuatmenganyam-ketupat-ray.html>
- <http://www.AbsoluteAstronomy.com> (2009).
- [http://www. aCeh Forum Community.htm](http://www.aCehForumCommunity.htm), *Sejarah Ketupat*, [2008 April 12].
- <http://id.shvoong.com/humanities/arts/1990826-unsur-unsur-senirupa>.
- [http://www.Tim Koordinasi Siaran Direktorat Jenderal Kebudayaan](http://www.TimKoordinasiSiaranDirektoratJenderalKebudayaan). 1995. *Aneka Ragam Khasanah Budaya Nusantara VI*. Jakarta: Departemen Pendidikan dan Kebudayaan.

## Don't Let Javanese Language Become Extinct by Using Javanese Language to Preserve Cultural Heritage of Indonesia In Java Youth Scope

**NAFISA SYAHIDA RAHMADINI**

Brebes - Central Java, [nafisasyahida1412@gmail.com](mailto:nafisasyahida1412@gmail.com), +6287830114437

### ABSTRACT

Javanese is the principal language of Java. Javanese is a Sundic language of the Western Malayo-Polynesian branch of the Austronesian language family. Although it is related to Indonesian, it is most closely related to Malay, Sundanese, Madurese, and Balinese ([www.wikipedia.org](http://www.wikipedia.org)). With respect to the geographical distribution, the language is spoken principally in the central and eastern regions of Java but with different variations or dialects. In addition, Javanese is spoken in the northern coastal regions of the western portion of the island, mainly around Banten and Cirebon. Javanese language that used to be great language. However, the increasing time, the Javanese language now increasingly extinct. Especially, to the almost Javanese youth, they do not mastering Javanese language, they claimed to shame and pride using Javanese language and they preferred slang to talk everyday. Well, *it's a big point as a youngster of Indonesia to keep our culture and especially our native language* And I'm as a native of Java, In this right opportunity, I'll proud and enthusiasm to introduce more about Javanese language to the world and I would to invite them to preserve the Javanese language, especially to the young researchers from **Indonesia, Malaysia, Bangladesh, and Ireland**. So, the question, who else is going to pass on cultural heritage if not us? **Keep our native language!**

**Keywords** : Javanese, Language, Culture, Extinct, Keep.

## 1. Introduction

Humans are social beings and individuals. As social beings, humans need to interact with other humans. In interaction, humans require language to express his thoughts. According to *Kridalaksana* (2001), language is a system of arbitrary sound symbol used by the members of a community to work together, interact and identify yourself. As such, language is an important element in a communication. In this world, a lot of the language used in human interaction. Each of region and country has its own language. No exception in Indonesia, which has a variety of ethnic groups. More or less, there are about 500 to 700 the Indonesian ethnic that each tribe has its own regional language (*Katitira*, 2007). In fact, in one tribe has a different language, for example, in Javanese there are differences between Javanese language in Yogyakarta with Javanese language in Surabaya.

Javanese is the language of the Javanese people from the central and eastern parts of the island of Java, Indonesia. There are also pockets of Javanese speakers in the northern coast of western Java. It is the native language of more than 98,417,022 people (more than 42% of the total population of Indonesia).

Javanese is part of the Austronesian languages, but it is otherwise not particularly close to other languages and is difficult to classify, though not too dissimilar from neighboring languages such as Sundanese, Madurese and Balinese. Most speakers of Javanese also speak Indonesian (a standardized form of Malay) for official and commercial purposes, as well as a means to communicate with non-Javanese Indonesians. There are speakers of Javanese in Malaysia (concentrated in the states of Selangor and Johor) and Singapore. Some people of Javanese descent in Suriname (the Dutch colony of Suriname until 1975) speak a creole descendant of the language. ([www.wikipedia.org](http://www.wikipedia.org))

Javanese language that used to be a great language, with increasing time, its use less and less. Nowadays, the youth in Java, especially, those who are at the school age, mostly not mastering Javanese language. This could be caused by the incessant invasion of diverse foreign cultures and the flow of information that goes through various means such as television and etc.

Using of slang, foreign language, and the language their own wishes (e.g. mixture by Javanese, Indonesia, and English) also contributed to the condition of Javanese language that increasingly downs. Why not, currently, the students primary school to high school who get most of the Javanese language lessons from school. While the Javanese language lessons once a compulsory subject even started to be removed from the list of the school lesson. Even though, there are hours of subjects, it is also very few, only 45 minutes twice a week, while the use of Javanese language in surrounding environment is no longer as tight as in the first period. Parents do not get use anymore to use Javanese language as an everyday language to communicate in family area. Most of the Indonesian or even teach a foreign language to their children. Javanese language, especially *Krama Inggil* (part of Javanese language) is increasingly abandoned.

Actually, in Javanese language are contains of moral norms, manners, respect for the younger and older. Often, someone is using Javanese language in daily communication, but They are often forget that there is a level to use of Javanese language. The negative impact of this case is the youth of Javanese more impolite and does not respect to the older. Because Javanese language become extinct, so it makes the quality, manners, and etiquette of Javanese youth in decreasing. Therefore, Javanese language education should be inculcated from childhood. So that, the Javanese language will keep in heritage and not become extinct. As well as to the world view that we are as the young generation have to keep our culture especially for our native language. And the writer said **“proud to be youth Javanese, using Javanese language, and view to the world that Javanese language will not extinct”**. Well, in this good opportunity, from IJCIMBI 2015 event, is a good way to introduce, recognize, and learn more about the Javanese language. And then, the writer will give solution to spread widely of Javanese language to keep a part of Indonesia’s cultural heritage.

## 2. Knowing The Javanese Language

### 2.1 The Levels of Politeness and Javanese language structure

In common with other Austronesian languages, Javanese is spoken differently depending on social context. In Austronesian, there are often three distinct style or registers. Each employs its own vocabulary, grammatical rules, and even prosody.

a. *Ngoko*

Informal speech, used between friends and close relatives. It is also used by persons of higher status (such as elders or bosses) addressing those of lower status (young people, or subordinate in the workplace).

b. *Madya*

Intermediate between *ngoko* and *krama*. Strangers on the street would use it, where status differences may be unknown and one wants to be neither too formal nor too informal. The term is from Sanskrit *madhya* (middle).

c. *Krama*

The polite and formal style. It is used between those of the same status when they do not wish to be informal. It is used by persons of lower status to person of higher status, such as young people to their elders, or subordinate to bosses, and it is the official style for public speeches, announcements, etc. The term is from Sanskrit *krama* (in order).

Table 1 : Example of Ngoko, Madya and Krama vocabularies

<b>Ngoko</b>	<b>Madya</b>	<b>Krama</b>	<b>English Meaning</b>
<i>kowe</i>	<i>Sampeyan</i>	<i>Panjenengan</i>	You
<i>Gelem</i>	<i>Purun</i>	<i>Kersa</i>	Want
<i>Mangan</i>	<i>Nedha</i>	<i>Dhahar</i>	Eat

There are also “meta-style” honorific words, and their converse “*humilifics*”. Speakers use “humble” words concerning themselves, but honorific words concerning anyone of greater age or higher social status. The *humilific* words are called *krama andhap*, while the honorifics are called *krama inggil*. Children typically use the *ngoko* style, but in talking to the parents they must be competent with both *krama inggil* and *krama andhap*. Some examples :

- *Ngoko* : *Aku arep mangan.* (“I want to eat.”)
- *Madya* : *Kula ajeng nedha*
- *Krama* :
  - (Neutral) *Kula badhe nadhi*
  - (Humble) *Dalem badhe nedhi*

The most polite word meaning “eat” is *dhahar*. But it is forbidden to use these most polite words for oneself, except when talking with someone of lower status, and in this case *ngoko* style is used. Such most polite words are reserves for addressing people of higher status.



### **3. The Case of Javanese Language Among The Youth Java**

Globalization era, especially among youth requires one to be able for using language of global and worldwide with the purpose to active role in modernization era. For example, using of English in city environment in daily life. It has negative impact position of Javanese language, that is increasingly neglected.

The waning of Javanese language in Java certainly has a variety of the real reasons. It able be seen and felt of Javanese language that currently have plummeted. Many youths can not use Javanese language well, and they prefer to use Indonesian. However, this factors who can not use Javanese language, it is not fully youth's fault. But, many factors that cause it happened. The family includes the most influential factor, because the family is the first social environment known by children.

There are several factors that cause decline in the Java language among the youth. According to Ipung (2011) :

#### **1. Factor of youth**

Youth tend to feel embarrassed to use the Javanese language in daily conversation the reasons are Javanese language is ancient, they do not know the meaning and also confusing. Actually, the feeling of shame influenced by their friends who also embarrassed to use Javanese language.

#### **2. Factor of family**

Parents also be a role model in the development of Javanese language. Parents are the ones who will preserve this culture to their children, so the children will apply when speaking especially to older people. Instead, parents educate their children even in Indonesian language even English in daily conversation. Not infrequently, parents use Indonesian to communicate with their children but using Javanese language to communicate with others. If all parents do that, in a short time Javanese culture in Java will fade, destroyed and sunk. No more generations can continue Javanese language, because the young generation will be a parent in the future, and if they are not informing about the Javanese language may be not able to teach the next generation.

#### **3. Factor of school**

The allocation for hours of the Javanese language lesson in elementary school, junior high school and senior high school only two hours. Even now, there are some schools that do not teach Javanese language to educate in their school. This was strengthened by many schools, especially for private schools, were concerned Javanese language can make students burdened. The program of Speak Javanese day initiated by Department of Education (Dispendik) responded Surabaya among private schools. They have opinion if use of local language that would hamper the communication process of teaching and learning activities. There are fears of launching the Javanese language can make students feel burdened (Java Post, 2008).

#### **4. Factor of government**

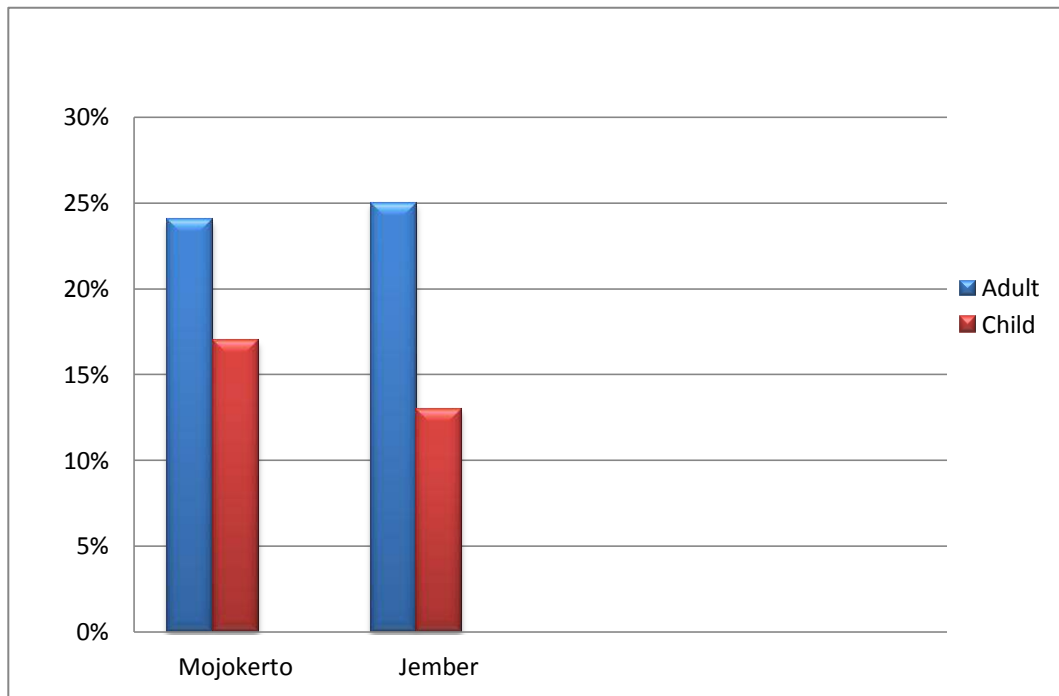
The local governments are not giving attention to activities that lead to the preservation of the Javanese language. Because the local governments do not create institutions or courses for Javanese language, and a lack of removal of the Javanese language education teacher may also cause silting of the Javanese language.

Public awareness of culture itself is more less. The society tending to try follow a new culture as the reasons are not ancient and primitive. So, with a slowly Javanese culture will be extinct in Java island.

### **4. Study Case of Javanese Language**

Javanese language is highly praised for its cultural values deeply rooted in the structure and communicative usage of the language itself. The variation of krama in Javanese language reflects the wisdom of its society to honor and respect other people in a communication. Unfortunately, the language shift phenomenon seems unavoidable along with the major development in the global world. This research conveys the position of Javanese language among the youngsters' communication choices. This is a case study conducted in two areas namely Desa Randegan (Mojokerto) and Dusun Tutul (Jember). The research shows that the use of Krama has significantly shifted to Bahasa Indonesia due to children's

bilinguality, the advance in media and technology, and inability of the learning process at schools to accommodate the communicative use of Javanese language.



From the research, the lexicon can be seen that there is a gap quantity lexicon high of krama in adults and children. This suggests that the mother tongue continuity of the older generation to the younger generation does not run smoothly. The higher gaps were found in both the observation area. This suggests that the two observation areas have problems in terms of sustainability of the mother tongue.

## 5. Solution to Keep and Preserve Javanese Language as Indonesia Cultural Heritage

At that time, the users of Javanese language is not more, especially for the youth, they assume that the Javanese language is difficult language and ancient. They are unusual to speak Javanese language, and therefore some people said that the Javanese language will be extinct, because the Javanese themselves are not understand about Javanese language.

This is a very bad situation, if the Javanese language completely extinct. Then indeed the Javanese have lost their culture. Basically, the society should be realize to keep Javanese culture. Not to be a reason that with the advancement of society moving towards a modern society and then simply forget their own traditions. So, do not let the people leave Javanese culture solely for modernization.

In addition, there are several ways that we can do to preserve the extinct of Javanese language :

1. The first way is to defeat the factors:

a. Factor of Youth itself

As the youth especially for the Javanese, they must be proud of their language itself. They must push away the embarrassing feeling in speaks Javanese, and they must growth their confidence in speaks Javanese. So, by doing this way, we can avoid such what has been written that the youth embarrassed to speak Javanese.

b. Factor of family

The parents as the first society of someone, especially for children and youth, must teach their children about Javanese, applying Javanese in daily in their home, insist and motivate their children that Javanese is their language that they must be proud of it, and as the young, the Javanese is their treasure and legacy that they must be preserve. So, by doing that, the children will realize that the existence of Javanese is their responsibility as the generation that will continue it.

c. Factor of school

In this side, school as the education society should support the developing of Javanese language. As an educational place, school must give more treat to explore Javanese Language. The school must support the existence of Javanese language and preserve it from extinct by doing some ways such as by adding Javanese language as one of lesson in school, and each of school, state or private school, must provide the Javanese Language lesson.

d. Factor of Government

In a way to avoid what have been written in the explanation before, the government must provide a technique that can applied in society and keep the Javanese language exist. One kind of the techniques is doing the action by Javanese Day that have been made by Department of Education (Dispendik). The youth, school, organization, and all parts in society must support the regulation and applying it in daily as a feeling of honor for our language, and as a way that can preserve the extinct.

2. The second: using media as a way to spread Javanese language and preserve from extinct. In this case, there have been some kinds of media that have been done to spread the Javanese language such as through television, radio, and newspaper. As the youth, we must realized that we must response for this way by taking and enjoying the media, such as listen to Javanese radio, read the Javanese column in newspaper, and gives time to watch everything about Javanese in television.

In closing this paper, I provide some ways to keep the existence of Javanese according to Rahardjo (2001) :

1. Give the education about Javanese language and culture to the children even since under five years. So that, they will not assume that Javanese language is an ancient language, at last they will used to speak Javanese language in daily life.
2. Make ourselves used to speak Javanese language with correct way in daily life. So, the children will learn it, and the language will be exist anymore.
3. Teach the Javanese language, formal and informal ways, in school and society.

## **6. Conclusion**

Based on the description that has been mentioned it is known that Javanese language has a very important role in everyday life as a communication tool. using the Java language also has a level of politeness that should be placed. There are several types of forms variance explained in Javanese language namely is unggah-ungguhing basa. However, the development of time makes Javanese language more extinct and considered unimportant. Many factors cause Javanese language being abandoned. The community considers Javanese language is the language of the villagers, those edges, or those bygone era. They claim to be embarrassed and ashamed to use Javanese language and prefer to use the Indonesian language or slang. The entry of western culture is also a factor of Javanese language more extinct, and considered unimportant.

As youth generation and indigenous people of Java, we must preserve the language and culture of Java. Who else if not us for keep our language and culture? Do not until after culture has been lost or otherwise belonging to another country then the people concerned and feel have it. Maintain from now is very important in order not regret later. Ways to maintain and preserve them by implanting Javanese language early on, get used to using

Javanese language in daily life, teaching Javanese language both formal (school) and informal (society). So, keep or culture and language, and don't let Javanese language become extinct.

### **Refrence**

<http://colasula.com/?p=900>

[http://library.unej.ac.id/client/en\\_US/default/search/asset/873?dt=list](http://library.unej.ac.id/client/en_US/default/search/asset/873?dt=list)

[http://en.wikipedia.org/wiki/Javanese\\_language](http://en.wikipedia.org/wiki/Javanese_language)

<file:///E:/Penggunaan%20Bahasa%20Jawa%20untuk%20Melestarikan%20Warisan%20Budaya%20Indonesia%20dalam%20Lingkup%20Pemuda%20Jawa.htm>

## Taking a collaborative approach to solving students' problems at tertiary level

<sup>1</sup>Nazia Nishat, & <sup>2</sup>Yousuf M. Islam

<sup>1</sup>Daffodil International University, [nazia.swe@daffodilvarsity.edu.bd](mailto:nazia.swe@daffodilvarsity.edu.bd), +8801681466687

<sup>2</sup>Daffodil International University, [ymislam@daffodilvarsity.edu.bd](mailto:ymislam@daffodilvarsity.edu.bd), +8801711876909

### Abstract

Students progressing to tertiary level education often have many problems – problems that may affect their studies. Those who have to live away from home to attend the university also have their own set of problems. To provide support many universities have counseling offices to help the students tackle their problems. The counseling officers often give repeated appointments in an attempt to help solve these problems. At Daffodil International University (DIU), a relatively new private university, more than 75% of the students come from a rural background, *i.e.*, they have had to move to the urban metropolitan city of Dhaka for the purpose of their tertiary level education. These students have additional problems like adjusting to urban life, missing home, managing all household chores by themselves, even a culture shock of urban life, *etc.*, all of which may affect their studies. Being a new university, DIU does not employ a student counselor. So at DIU we experimented with a collaborative approach to solving student problems. From three different departments, Software Engineering, English and Law we took students with a low CGPA (<2.5) and held a collaborative problem solving workshop. The students were guided in a collaborative environment where individual problems were identified anonymously and possible solutions were presented by the students collaboratively working in groups. The paper shares the collaborative technique applied, examines the subsequent change in CGPA of the students and presents the findings from post-interviews of the students. The perception of effectiveness of collaborative guidance model was thus also measured by taking feedback from students. Finally the collaborative problem solving approach is compared with the traditional counseling approach.

**Keywords:** *Collaborative problem solving, peer counseling, rural students, traditional counseling,*

### 1 Introduction

Students progressing to tertiary level education often have many problems – problems that may affect their studies. Those who have to live away from home to attend a university also have their own set of problems. Researching student problems at their university, Walsh, Crawford & Macdonald (1999) reported that students from the rural and remote areas have been identified as an “at-risk” group. 7% of the students at Swinburne University consist of students from rural and remote areas of Victoria. The problems found centre around financial difficulties, social and emotional issues associated with moving away from established networks, academic difficulties and limited access to information about courses in the tertiary sector. To provide support many universities have counseling offices to help such students tackle their problems.

According to Jewel(2013) private universities are booming in Bangladesh because the traditional public universities have a limited capacity in comparison with growing/increasing number of students and the increased demand for tertiary education. At Daffodil International University (DIU), a relatively new private university, more than 75% of the students come from a rural background, *i.e.*, they have had to move to the urban city for the purpose of attending the university.

According to the Chairman, Board of Trustees, Khan (n.d.), Daffodil International University aims to take on the challenge of providing disadvantaged rural students the opportunity to have tertiary level education. To mitigate the gap between the rural and the urban students and to equip them with modern technology he initiated the One Student One Laptop Project. While this is a visionary aim, realities on the ground are that these students face many problems, often having to drop-out from the system after having spent a lot of time, money and effort during the initial days of joining the university. Many who try to stick it out have a low CGPA. Students with a CGPA of 2.5 or less risk not graduating as rules of the University Grants Commission (UGC) do not permit the award to degrees to low CGPAs.

The number of students with low CGPA is on the increase as is the number of rural students. How can the problem be solved, *i.e.*, how can students with low CGPA be helped? This paper looks at an innovative collaborative approach that may be used to tackle this problem.

## **2 Peer-counseling:**

The approach, traditionally, is that counseling would help at risk students. Modo(2008,as cited in Oliremi,n.d.) defines counseling as a helping relationship between the counselor and the counselee. It is aimed at helping the counselee adjust properly to family, school, peer association, and society in general.

The task of a counselor identified by Okonkwo & Anagbogu (2008, as cited in Oliremi, n.d.) is:

“Counseling is a process of helping a troubled person to understand himself and his work so as to feel and behave in a more personally satisfying manner.”

This formal counseling process needs an experienced counselor with whom a student can share his/her problem. It is noted however Henry (n.d.) states that students give prefer to share their problem with other students – thus the birth of peer counseling.

To assess the preference of counseling by peers, Henry (n.d.) did a survey that suggests

“Most students would rather seek help from other students with personal problems rather than ask for help from an adult.” (Henry, n.d.)

Presentation slides of author Tindall & Gray (n.d., as cited in authorSTREAM,2014) defines peer counseling as:

“Peer counseling is defined as a variety of interpersonal helping behaviors assumed by nonprofessionals who undertake a helping role with others.”

PACE (2015) prescribes the importance of Peer Counseling as one of the most viable benefits of being in contact with people who have had a similar experience.

Henry (n.d.) provides a useful resource on the background and theory of peer counseling. He discusses how peer counselors are engaged:

“Students are trained in communication skills & how to apply them.”

Essentially, an experienced counselor is replaced by a senior student. Henry (n.d.) stated Senior students are trained on the following tasks:

- Listening & understanding
- Decision making assistance
- Mediation & conflict resolution
- Problem solving

### **2.1 Peer Counseling Benefits**

Research on peer counseling is supported by statistics which show

“There is a significant decrease in disruptive classroom behaviors for students participating in peer counseling services” (Bowman, 1987, as cited in Henry, n.d.)

Another study on peer counselors proposed,

“Middle School peer counselors can help decrease the disruptive behaviors of students’ viewed as disciplinary problems, improve attendance, grades, and overall attitudes” (Tobias, 1999, as cited in Henry, n.d.)

## **2.2 Benefits of the peer-counselor:**

According to Mcdowell(2010) on a judgment or comments on benefits of peer counseling of the Youth Bureau, a graduate said,

“Peer Counseling teaches you what you can’t learn in a normal classroom. It’s not something you can read in a textbook,” she said. “The program helps you grow as a person and build self-confidence. I know I’ve changed so much as a person.”

Blad(2015) reported how peer counseling helps grades and empowers the person who helps:

“It becomes a very positive feedback loop where, by the act of helping the school out, that older student is in fact deepening his or her own education,” Mr. Oscar said. “Leadership is increasingly something that we don’t only expect from the person who has the top title in an organization. It’s something we expect from everyone.”

In the examples above, not only does the counselee benefit, but also the peer counselor gains many skills. In our case, we experimented with more of a collaborative approach to counseling. Wikipedia (2015) prescribes:

“Collaboration is working with others to do a task and to achieve shared goals.”

Dance (2008) described the importance of collaboration and suggested that collaboration is a central theme to innovation because of

1. Associations
2. Speed
3. Connections
4. Energy &
5. Implementation

As collaboration stimulates innovation, it can identify & solve problems of various aspects to achieve our goal of empowering the students to solve problems.

## **3 Proposed model:**

As DIU is a new private university which has taken on the challenge of developing disadvantaged rural students. The university does not currently employ a student counselor. In an effort to see what can be done, we experimented with a collaborative workshop approach to solving student problems.

The objective of the workshop was to:

1. Get the students to explore the reasons behind their low CGPAs.
2. Once the students reported their perceptions, to empower the students to help themselves collaboratively solve the highlighted problems.

Students were motivated to recognize their own problems and develop trust in their own abilities to solve the problems. They were asked to discuss in pairs and to write their own problems on 3” x 5” cards without adding their names. Students worked in pairs wrote one problem per card. Students were allowed multiple cards for additional problems. The card technique is an adaptation of a workshop participatory technique first introduced by UNICEF Bangladesh (1993).

Once the students had discussed reasons behind their low performance with their peers (in pairs) the cards were displayed on the board for the whole class to see. The students then participated in a collaborative exercise to classify all the cards under common group titles. This gave the students a second chance to clarify what they had written on the cards. Once the cards were grouped it allowed the students to see that others also have similar problems, *i.e.*, that they are not alone, there are others in the same boat. While describing importance of Peer Counseling PACE(2015) stated that:

There is first a feeling of relief – “I am not the only person experiencing this”.

The class was then divided into the same number of groups as the number of card groups. The groups collaboratively discussed and presented solutions to the problems mentioned. The technique, given the name Participatory Engaging Problem Solving Intervention (PEPSI) is compared with traditional peer counseling in Table 1.

*Table 1 Traditional Peer Counseling vs PEPSI*

<b>Traditional Peer Counseling</b>	<b>Participatory Engaging Problem Solving Intervention (PEPSI)</b>
Individual student registers for help from a trained peer counselor	Students register for PEPSI workshop together with students having similar problems
Peer counselor gives a patient ear to the problem/s	Students discuss their problems with students having similar problems. They bring clarity and definition to their problem by documenting one idea per card. Students then group similar ideas and notice that others also have similar problems (this helps them identify with the group)
Peer counselor suggests solution	Students working in groups solve the problem collaboratively. They present and discuss their solution to the rest of the class.
Student works on solution	As student has himself/herself worked on and discussed the solution, he/she has ownership of the solution.
Peer counselor gives additional sessions as required.	Additional workshops are only necessary if the student feels he/she would like to attend another workshop.
<ul style="list-style-type: none"> <li>• Peer counselors have to be regularly trained</li> </ul>	No training is required. Students who have attended a workshop can volunteer to run similar workshops.
<ul style="list-style-type: none"> <li>• The identity and the problem of the student is known to the counselor</li> </ul>	The identity of the persons with the problem is secure as the cards are anonymous.
<ul style="list-style-type: none"> <li>• A dependency on the student counselor is implied.</li> </ul>	There is no implied dependency.

The common feature in both the counseling methods is the use of peers. However, in the PEPSI method, peers are those who have similar problems and are not trained in the art of counseling. In the PEPSI method, peers collaboratively decide on the problems and propose solutions themselves.

## **4 Methodology**

From three different departments, Software Engineering, English and Law we invited students with a low CGPA (<2.5) and held a collaborative problem solving or peer counseling workshop that we have named PEPSI. In the workshop we surveyed that there were 83.33% rural students and 16.66% urban students. So the workshop was held on students who got CGPA less than 2.5 and most of them were found to be from a rural background..

For the students, three different workshops were held, one for each department, with a total population of n = 78. Judging from the noise generated in each workshop, the students enjoyed the session very much.



## 4.1 Results

The participants of the 3 workshops generated around 30 cards each. Once the cards were grouped, the problems generated by each group are given in Table 2.

*Table 2. Problems grouped by the students of each department*

Students from the Department of Software Engineering n = 37	Students from the Department of Law n = 20	Students from the Department of English n = 21
Management of time, Leading a practical life, Motivation problems, English language skills, Students do not understand the class lecture	Hopeless (being without hope), Confusion (about the subject matter), English language skills, Students do not remember the class lecture, Family problems	Time management, Lack of study skills, Lack of language skills, Focus

Table 2 shows that the perceived reasons for the three groups are similar. Both types of problems are mentioned, *i.e.*, some put the blame on the institution and others blame themselves. However, when they grouped the problems and solved these, they took the initiative to improve themselves rather than ask the institution to improve. Tables 3 - 5 show sample solutions presented by the students. The columns on the right show solutions offered by trained and experienced counselors. To gauge the effectiveness of the workshop, in particular on their CGPA, the change in CGPA from the semester before and the semester after was calculated. The results were put through a t-test. Two semesters after the workshop, a group of six students were asked to fill out an evaluation form. Their interview responses are given.

Table 3: Collaborative Solutions given by the students on Time Management & Sample solutions given by professional counselor

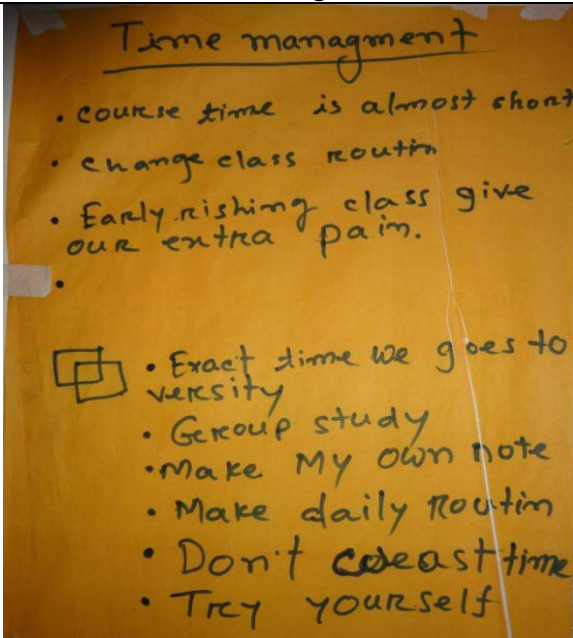
Area discussed	Collaborative Solutions given by the students on Time Management	Sample solution given by professional counselor
Time Management	 <p style="font-size: small;">Solution bullets:</p> <ul style="list-style-type: none"> <li>• Exact time we goes to versity (Being Punctual)</li> <li>• Group study</li> <li>• Make My own note(Prepare notes on class)</li> <li>• Make daily routine</li> <li>• Don't weast time</li> </ul> <p style="font-size: small;">Try yourself (Brackets added)</p>	<p>Time management techniques of Counseling &amp; testing center.(2012) are summarized here:</p> <ul style="list-style-type: none"> <li>• Create a work area for yourself</li> <li>• Recognize your obligations and reschedule your work time.</li> <li>• Break larger tasks, such as papers or projects, into smaller goal steps.</li> <li>• Create a schedule for yourself</li> </ul>

Table 4: Collaborative Solutions given by the students on Language skill & Sample solution given by experts

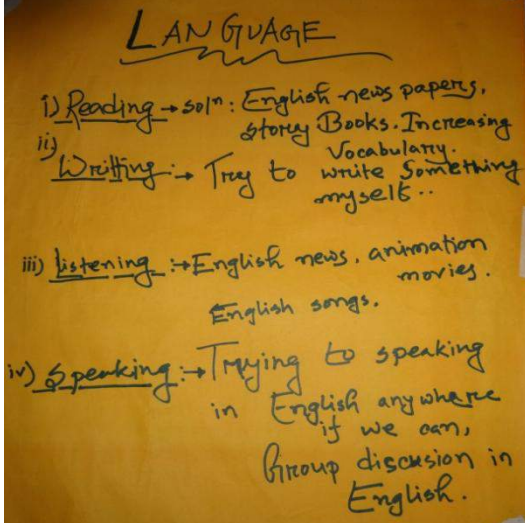
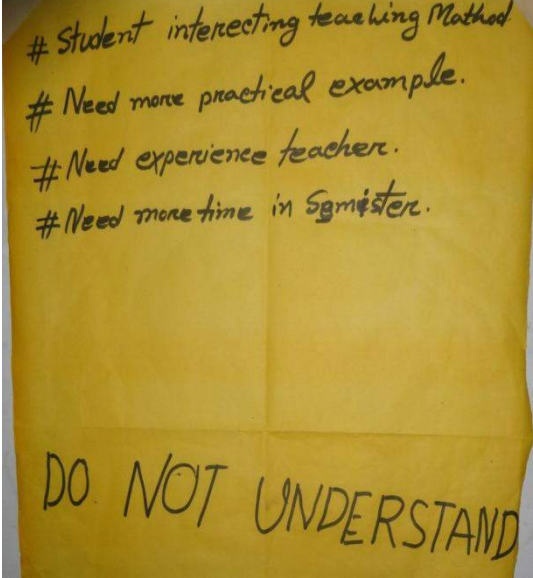
Area discussed	Collaborative Solutions given by the students on Language skill	Sample solutions given by experts
Language skill	 <p>Solution bullets:</p> <ul style="list-style-type: none"> <li>• Reading: English news papers, story Books, increasing vocabulary</li> <li>• Writing: Try to write something myself</li> <li>• Listening: English news, animation movies, English songs</li> <li>• Speaking: Trying to speaking in English anywhere if we can, group discussion in English.</li> </ul> <p>(Brackets added)</p>	<p>Williamson (2009) shared the ideas below to learn a language</p> <ol style="list-style-type: none"> <li>1. Personal campaign to master English</li> <li>2. Read the language as much as possible, ("If you like romance novels or science fiction, read romance novels or science fiction—in English! If you read the news, get the newspaper—in English. If you like sports, read sports reports in English.")</li> <li>3. Surround yourself with that language.</li> <li>4. Converse informally in English.</li> <li>5. Do not translate from your mother language.</li> <li>6. Talk to yourself in English.</li> <li>7. Get a paperback bilingual dictionary</li> <li>8. Get an English grammar guide and a verb-book.</li> <li>9. Get your work proofread</li> </ol>

Table 5: Collaborative Solutions given by the students on Teaching Problems & Sample solution given by professional counselor

Area discussed	Collaborative Solutions given by the students on Teaching method	Sample solution given by professional counselor
Teaching method	 <p>Solution bullets:</p> <ul style="list-style-type: none"> <li>• Student interacting teaching Method (Interactive teaching)</li> <li>• Need more practical example (Providing practical examples in class lecture)</li> <li>• Need experience teacher. (Need teachers with industry oriented experience)</li> <li>• Need more time in semester (A semester of 12 weeks is too short to absorb the subject)</li> <li>• Do not understand (Cannot grasp the subject just through lectures) (Brackets added)</li> </ul>	<p>Quirk(2013) prescribes 5 tips for making class interactive</p> <ol style="list-style-type: none"> <li>1. Give students tools that help to build a classroom community.</li> <li>2. Give students tools for brainstorming collaboratively.</li> <li>3. Give students tools that provide you with feedback about their opinions, goals, or learning.</li> <li>4. Give students tools that let them present their work and gather feedback.</li> <li>5. Give students a tool that lets them learn content at their own pace.</li> </ol>

## 4.2 Analysis

As seen in Tables 3 – 5, the solutions given by the students are comparable to those given by experts in the field. To see whether this helped the students to practically improve their GPAs, the GPAs of the students in the semester before the workshop and the GPAs in the semester afterwards was compared. This is shown in Table 6.

Table 6. Analysing CGPA after guidance workshop:

	%of increased GPA	% of decreased GPA	% of unchanged GPA
Pre Guidance Semester Fall, 2013 to Spring 2014	47.54%	42.62%	9.84%
Post Guidance Semester Spring 2014 to Fall 2014	42.62%	36.07%	21.31%

Table 6 shows no significant increase in GPAs, however, the number of GPAs steadied are significant.

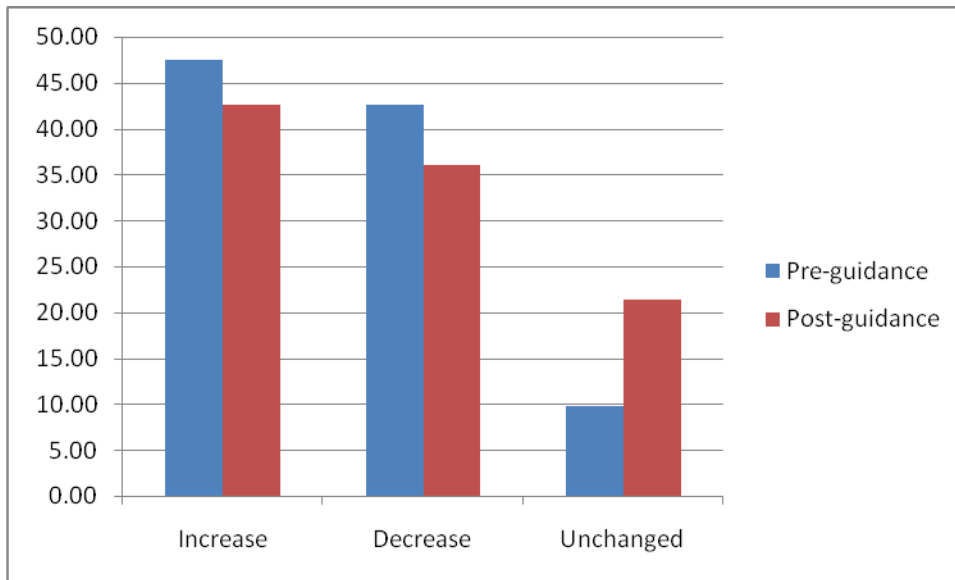


Figure 1 The change in GPA from semester to semester shown graphically

In addition to checking the change in GPAs, available students were called in to get feedback on their perceptions 8 months or 2 semesters after the workshop intervention. Their responses are shown in Table 7.

Table 7. Written evaluation by six students 8 months after the workshop

Student Responses	1.Has the workshop been useful to you? If yes please describe in what ways.	2.List in what ways you have used the workshop to improve your studies.	3.Mention which grades have improved after the workshop. Mention any attitude/outlook improvement.
1.	<i>Yes, I just determine to attend in class regularly and try to make my CGPA higher.</i>	<i>I get inspiration from there.Understand that I need to be more better.</i>	<i>Attitude cgpa before workshop less than 2.25 and after workshop 2.84</i>
2.	<i>Yes, It helps to make a way to study well.</i>	<i>I have attend that workshop on that class we have done group study and talk to each other and solved the problem.</i>	<i>That workshop really improve ourselves and improve confidence level.</i>
3.	<i>Yes, I am regular maintain all classes and study. I am trying the programming I attend the class.</i>	<i>I am improve my study. I think workshop is very important of our study. Here all students different different ways share with us. We need regular maintain with us. We need regular maintain in the classes and concentrated.</i>	<i>I am improved my study. I am following my teachers lecture and concentrated the classes. My attitudes very good.</i>

4.	<i>Definitely Yes, It helps us to make a way to study well. They teach us or train us. How can we develop ourselves, That was help us group our confidence.</i>	<i>I have attended that workshop. On the class we have done group works, Talked to each other, solve problems. We also talked to our respected teacher about our problems.</i>	<i>That workshop was really helpful to improve ourselves. Increase confidence. Before exams we were get frustrated from last three semester. I am improving myself. First I was really confused scary. Now a days I am remvng my scareness from exams.</i>
5.	<i>This workshop is useful for our mentally preparation and spair from study.</i>	<ol style="list-style-type: none"> <li>1. <i>Timely started study and maintain proper time.</i></li> <li>2. <i>After workshop my mentality have some change.</i></li> </ol>	<i>After workshop I realize my lack of study. So I continue to my study and worked to hardly. then my CGPA is up to some.</i>
6.	<i>Yes, When I was attended HRDI workshop that time I known how to inspired of reading. How to maintain discipline. How to regular attending class. How to cover our program and how to develop my CGPA.</i>	<p><i>I improved my studies, some of simple ways</i></p> <ol style="list-style-type: none"> <li>1. <i>Need a master plan.</i></li> <li>2. <i>Must be attend classes.</i></li> <li>3. <i>Your time will dividing for all studies.</i></li> <li>4. <i>Regular practice your program.</i></li> <li>5. <i>must be concentrate class time.</i></li> </ol>	<i>Basically, Previous time to this time I am serious about my study and also increasing my CGPA. This time fully concentrated teachers lectures. Now I am attempt to attend regular classes. that's it.</i>

## 5 Benefits and Conclusion

As seen from Table 7, the students are highly positive about the workshop with comments keywords such as *inspired, useful, study well, etc.* This is reflected in the fact that the drop in GPAs has steadied. Further research should validate the improvement and suggest policies to the university for installing the PEPSI workshop in each department of the university. Overall, the benefits of the workshop can be said to be:

### 5.1 Benefits of PEPSI workshop model:

In peer counseling students who acts as counselor get empowered, however, in the PEPSI model

- All participants act as counselor and are empowered
- So leadership is spread in all participants.
- Students get the ownership to solve their own problem
- Student got confidence after solving problems
- Their CGPA were more steady than other semesters

In conclusion we may confirm the findings of Dance (2008) as he stated that collaboration increases the chances of ASSOCIATIONS between ideas that result in innovative combinations, *i.e.*, without beings experts, students collaboratively suggest solutions that almost equal those of experts.

## 6 Reference

- authorSTREAM(2014).Peer counseling. Retrieved March 31, 2015 from <http://www.authorstream.com/Presentation/aSGuest89957-890566-peer-counseling/>
- Blad,E.(2015). Schools Explore Benefits of Peer Counseling.Article published on Education week.Retrieved March 26,2015 from <http://www.edweek.org/ew/articles/2014/04/23/29peerconnection.h33.html>
- Bowman,R.P.& Myrick,R.D.(1987).Effects on elementary school peer facilitator program on children with behavior problems.The school counselor. As cited in Henry (n.d)
- Counseling &testing center.(2012).Procrastination/Time management. Website of Oregon University.Retrieved March 30,2015 from <http://counseling.uoregon.edu/TopicsResources/StudentSelf-Help/ProcrastinationTimeManagement.aspx>
- Dance,J.(2008). 5 Reasons why collaboration contributes to innovation.freshconsulting.Retrieved March 31, 2015 from <http://www.freshconsulting.com/5-reasons-why-collaboration-contributes-to-innovation/>
- Henry, P. (n.d.). Peer Counseling Program. Middle School. Survey presentation slides. Retrieved March 21, 2015 from [http://notebook.lausd.net/pls/ptl/docs/PAGE/CA\\_LAUSD/FLDR\\_ORGANIZATIONS/COMMITTEE\\_MAIN/COMMITTEE\\_SSHHS/COMMITTEE\\_SSHHS\\_AGENDA/5.%20%20PEER%20COUNSELING.PDF](http://notebook.lausd.net/pls/ptl/docs/PAGE/CA_LAUSD/FLDR_ORGANIZATIONS/COMMITTEE_MAIN/COMMITTEE_SSHHS/COMMITTEE_SSHHS_AGENDA/5.%20%20PEER%20COUNSELING.PDF)
- Jewel,M.R.(2013). An Empirical Study on the challenges and prospects of Private Universities in Higher Education in Bangladesh .ICTERC. Institutional Digital Repository.Daffodil International University. Retrieved March 26,2015 from <http://dspace.daffodilvarsity.edu.bd:8080/handle/123456789/879>
- Khan,M.S.(n.d.). Accepting the challenge of including disadvantaged rural students at tertiary level.Daffodil International University Retrieved March 26,2015 from [http://saburkhan.info/images/Accepting-the-Challenge-of-including-disadvantaged-rural-students-at-tertiary-level\\_Md.-Sabur-Khan\\_Full-Paper.pdf](http://saburkhan.info/images/Accepting-the-Challenge-of-including-disadvantaged-rural-students-at-tertiary-level_Md.-Sabur-Khan_Full-Paper.pdf)
- Mcdowell,K.(2010) Students reap benefits of Peer Counseling. Article published on West Seneca Bee.Retrieved March 21, 2015 from [http://www.westsenecabee.com/news/2010-07-01/Front\\_Page/Students\\_reap\\_benefits\\_of\\_Peer\\_Counseling.html](http://www.westsenecabee.com/news/2010-07-01/Front_Page/Students_reap_benefits_of_Peer_Counseling.html)
- MODO, F. N. (2008). Counselling services for excellent academic performance among adolescents in secondary schools in UYO, Akwa-Ibom. *Conference Proceedings of Counselling Association of Nigeria(CASSON)*. As cited in Oliremi (n.d)
- OKONKWO, M. C. & Anagbogu, M. A. (2008). Role of teachers in promoting positive mental health for national development: Implication for counselling. *Conference Proceedings of Counselling Association of Nigeria (CASSON)*. As cited in Oliremi (n.d)
- Oliremi, F. D. (n.d). Functional Guidance and Counseling Centre Tertiary Institution. Website. Retrieved March 28, 2015 from [http://www.sosyalarastirmalar.com/cilt7/sayi31\\_pdf/6egitim/oluremi.pdf](http://www.sosyalarastirmalar.com/cilt7/sayi31_pdf/6egitim/oluremi.pdf)
- PACE(2015).Peer counseling. Website of center for independent living. Retrieved March 31, 2015 from <http://www.pacecil.org/general-services/peer-counseling/>
- Quirk,D.(2013).5 Tips for Creating an Interactive Classroom.Article published on Teq. Retrieved March 31, 2015 from [http://www.teq.com/blog/2013/07/5-tips-for-creating-an-interactive-classroom/#.VRmkh\\_CLWTZ](http://www.teq.com/blog/2013/07/5-tips-for-creating-an-interactive-classroom/#.VRmkh_CLWTZ)
- Tobias,A.K.& Myrick,R.D.(1999).A peer facilitator-led intervention with middle school problem behavior students.professional school counseling. As cited in Henry (n.d)
- UNICEF Bangladesh. (1993).Visualisation in Participatory Programmes: A manual for facilitators and trainers involved in participatory group events. Retrieved Jan 30, 2015 from [http://www.thehealthcompass.org/sites/default/files/strengthening\\_tools/VIPPmanual.pdf](http://www.thehealthcompass.org/sites/default/files/strengthening_tools/VIPPmanual.pdf)
- Walsh, M. E., Crawford, J. & Macdonald, I. D. H. (1999). Rural and Remote Students: Transition Issues in Accessing Tertiary Education. Paper delivered at Teaching and Learning Conference. Northern Territory University.Darwin Website: IMAC Education Pty Ltd. Retrieved March 22, 2015 from <http://www.imac-education.com.au/publications/Pub12.htm>
- Wikipedia(2015).Collaboration. Retrieved March 31, 2015 from <http://en.wikipedia.org/wiki/Collaboration>

Williamson, O. M. (2009). How to Overcome English Language Problems. Open Course Ware Website of University of Texas at El Paso. Retrieved March 30, 2015 from [http://utminers.utep.edu/omwilliamson/english\\_language\\_problems.htm](http://utminers.utep.edu/omwilliamson/english_language_problems.htm)

## **The Overview Application Of School's Activity Of Healthy Development Environment At Uks Program On Senior High School Level In Serang City**

Rahayu Sukamto<sup>1</sup>

<sup>1</sup>Faculty of Public Health, University of Indonesia, [rahayusukamto@yahoo.com](mailto:rahayusukamto@yahoo.com), 08121235604

UKS coaching is one effort to maintenance and improvement of health, addressed to students, which is one important link in improving the physical quality of the population. Healthy environment at school is the most substantial part for a healthy environment because it can support a human being become healthy and improve productivity, one of the objectives of the UKS program is the development of environmental healthschool.

General purpose of this study was to determine the overview application of development activities in the environmental healthschool on senior high school level with strata minimum in Serang City in 2011. The research design that used in this research is descriptive. The results of the study suggest that there needs for a joint commitment from the local government and cross-sectoral cooperation between health agency, education agency, interior department, religion department based on LCS of four ministers, the support of local government, including the availability of programs, budgets and development in stages, and control by by Serang City Health Department and also the implementation of a comprehensive UKS program.

**Keywords:**

UKS, the environmental healthschool Coaching, SLTA Bibliography: 16 pieces (1988-2010)



## **INTRODUCTION**

Environmental health is a reciprocal relationship between humans and the environment that results or affect to the human's health. (Water R Lym). The school environment is order to protect students and school staff from accidents and diseases and to improve prevention activities and develop attitudes towards risk factors that can cause disease (Health Department, 2008).

Sanitation is a control effort of human environmental factors that affecting or may be affected, that can detriment of physical development, health and survival (Health Department, 2008). Basic sanitation facilities like water supply, provision of latrines, waste management and waste water management has not filled up the applicable standards. Those Four basic factors sanitation is very influential on the health aspects of the others environment. Therefore the school environment should have conducive or have a physical environment such facilities include a proper school building, with sufficient ventilation and lighting, waste water disposal, toilets, garbage disposal, school buildings must be equipped with a school fence, yard or school garden. And environmental sanitation program aims to create more healthy environment quality in order to protect the public from all possible events that may cause interference or danger to the health towards to the a better health of society. To realize these objectives the main activities undertaken were environmental quality monitoring, environmental pollution control, prevention of extraordinary events, education, training and health education environment (Health Department, 1999). Scope of School Health Unit Program (UKS) is reflected in the Three Principals School Health Unit Program (TRIAS UKS), as follows:

1. Management of health education
2. Management of Health Services
3. Environmental Development of Healthy Schools life, whether physical, mental, social and environmental. (Health Department, 2003).

Based on the limitations issue done, then the conceptual framework taken in this study were: Development Application of Healthy School Environment activity at UKS Programmed with minimal strata including UKS Policy, Implementation of healthy school environment development activities, There were sanitation facilities of clean water, hand washing, There were latrine sanitation facilities, no sanitation trash facilities, There were sanitation wastewater facilities, There was yard, garden and field, there was UKS corner facility, There was the availability of the dangers of smoking, There were posters dangers of drugs, supervision over the school shop / canteen, implementation of eradication activities and mosquito larvae (3M plus, 1 time a week), Ownership shop / cafeteria, Ownership worship place, UKS program with a minimum level of healthy school environment.

Initial survey in Banten that less applicable towards UKS program was caused by a lack of policy support, limited funds, facilities and infrastructure, as well as human resources participation as UKS program implementer. 47 schools that did not have the UKS room from total of 52 schools (Summary data of Serang city Dindik 2010).

School health program in Serang city which has already running: health education programs, health networking, Healthy Schools Competition, advanced study Dental Health Unit (UKGS), Little Doctor program, providing facilities including a library, prayer room, and the room unit UKS. From existing schools number, known that not all senior high school (SLTA) had space School Health Unit (UKS). Total of 47 schools did not have any space School Health Unit (UKS) from the total number of Senior High School (SLTA) as much as 52 schools. (Summary of Data Department of Education in 2010)

## **RESEARCH METHODOLOGY**

The study design was descriptive it was kind of a study to describe the frequency distribution of the implementation of development activities healthy school environment with minimal strata program School Health Unit (UKS) at senior high school level in Serang.

Population and sample in the study were all high school located in Serang city as much as 52 high schools.

**RESEARCH RESULT:**

1. Overview UKS Policy at high school in Serang

Table 1.

UKS Policy frequency distribution at Senior high school in Serang

<b>Application of a healthy school environment development activities</b>	<b>Amount</b>	<b>Percentage (%)</b>
available	17	32.7
not available	35	67.3
total	52	100

Research results in *Table 1* above showed that 52 respondents (100%) at Senior high school in Serang City did not have any UKS policy.

Policy is a binding rule in the form of a shared commitment to become a guidance and direction in the act. (Sullivan, 2000). The absence of UKS policy throughout all Senior high school in Serang affect to coaching of school children in an effort to improve the health of school-age children has not done yet . And also the lack of thorough socialization and commitment in the implementation of school health program by the City Health Office of Serangcity where the policy was already existed, so it needed for revitalization, supported by institutions across relevant sectors as specified in the Joint Decree of 4 (four) Minister, they were the Minister of Health, Minister of Education, Minister of Religious Affairs and the Minister of the Interior. The policy should be implemented in the region with emphasis program to the institute.

2. Description of the implementation of healthy school environment development activities at the high school in Serang.

Table 2

Frequency distribution of the application of  
Healthy School Environment Development activities at Senior high school in Serang

<b>UKS Policy</b>	<b>Amount</b>	<b>Percentage (%)</b>
available	0	0
Not available	52	100
Total	52	100

Research results in *Table 2* above showed that schools that hadHealthy School Environment Development activities were 17 schools (32, 7%) and schools that did not have a healthy school environment development activity were 35 schools (67.3%).

Healthy school environmentdevelopment activities at high school in Serang city has not been implemented optimally, the quality and intensity of health education on the importance of a healthy environment from Serang City Health Department, especially the school's UKS holder through the approach to the school principal, UKS teachers and teens health cadres must be in increase again. this was in accordance with the purpose of School Health Unit (UKS) was to improve the quality of education and learning achievement of learners to improve hygiene and health behavior and health status of students and create a healthy environment, thus enable the growth and the harmonious development and optimized in order to make Indonesian fully humanestablishment because fostering the physical environment of the school was one of the main program of the triad of School Health Unit (UKS) which includes:

- a) Provision of clean water
- b) Shelter water
- c) Procurement and maintenance of landfills
- d) Procurement and Maintenance Wastewater (SPAL)
- e) Maintenance of WC / toilet / urinal
- f) Maintenance of the bathroom
- g) Maintenance of cleanliness and tidinessof the classroom, library, laboratory space, and the worship place
- h) Maintenance of cleanliness and beauty of the school yard and gardens (including the greening of school)
- i) Procurement and maintenanceof school shop / canteen
- j) Procurement and maintenance of the school fence

3. Overview of Clean Water sanitation facilities at the Senior high school in Serang

Table 3  
Frequency distribution of sanitary facilities

Sanitation of clean water facilities	Amount	Percentage (%)
Eligible	29	55.8
Not eligible	23	44.2
Total	52	100

Results in Table 3 showed that from the 52 respondents, schools that had sanitation facilities of clean water at Senior high school in Serang City were qualified as much as 29 schools (55.8%) schools with unqualified sanitary facilities of clean water were 23 schools (44.2%). Deficient Sanitation facilities of clean water and did not have any sanitation facilities of clean water that filled up the health requirements including clean water source distance from the well impregnation / septic tanks and other sources of pollution (waste disposal, garbage disposal)  $\geq 10$  m / use PAM, quality Conditions of Physical water still found stained, smelly and taste.

Various microbial pathogens often transmitted through contaminated water that can cause disease in humans, so that clean water facilities must filled up the health requirements based on the rules established to prevent diseases associated with poor water supply systems, especially diarrhea which until now it is still the problem of Indonesia's health, even viewed by the morbidity and mortality caused. (Health Department, 1999).

This can potentially disease-based water (water base disease) such as diarrhea, typhoid, scabies, dysentery.

Need to do the monitoring / good supervision to enable the creation of better quality life in order to protect the public, especially school children from the danger that comes from the environment, so it can achieve the health of individuals, families and communities optimally. However, the overall of water supply can be well categorized.

4. Overview of Hand Washing facilities at Senior high school in Serang city

Table 4  
Frequency distribution Hand Wash in high school in Serang

Sanitation facilities Latrines	Amount	Percentage (%)
Eligible	2	3.8
Not eligible	50	96.2
Total	52	100

Research results in Table 4 showed that schools with qualified hand washing facilities at the high school in Serang was 1 school (1.9%), unqualified were 51 schools (98.1%). The proportion of hand washing facilities at Senior high school were still unwell in majority, based on the observations of researchers at the Senior high school, They had hand washing facilities but the water did not flow well and the unavailability of soap, and the proportion of hand washing was not fit can be seen from the still contained washrooms hand in each class, so this may have an impact on disease associated with clean and Healthy Lifestyle (PHBs) as diarrhea, intestinal worms, skin diseases and so on.

5. Overview of sanitary toilet facilities at the Senior high school in Serang

Table 5  
Frequency distribution of sanitary toilet facilities at the Senior high school in Serang

Hand Washing facilities	Amount	Percentage (%)
Eligible	1	1.9
Not eligible	51	98.1
Total	52	100

Research results in *Table 5* can be described that the qualify sanitary latrine facilities at the Senior high school in Serang were 2 schools (3.8%) and the unqualified were 50 schools (96.2%). It can be described that the proportion of sanitary latrine facilities at Senior high school still was quite low, based on observations of researchers at the Senior high school, They did not have any sanitary latrine facilities that filled up the health requirements, such as (there was no separation between boys and girls, unclean and smelly, ventilation and lighting was not enough, there was a puddle of water and sometimes there were mosquitos / mosquito larvae).

According to the Directorate General of Communicable Disease Control and Environmental Sanitation of health department 1985 The meaning of latrines is a building used to dispose of the stool / feces / unclean for family, commonly called toilet / WC.

Faeces or human feces seen as objects in terms of harm to human health, as a source of transmission of diseases such as typhus abdominal stomach, cholera, bacillary dysentri, and amoebae as well as various types of worms (PPM general director and PLP of health department). So that it can have an impact on the health of school children, especially diseases associated with human feces like typhoid, dysentri, cholera and intestinal worms and mosquito vector-based like Dengue, chikungunya, filariasis.

#### 6. Description of sanitation facilities in the trash at the high school Serang

Table 6  
Frequency distribution of sanitary facilities of Trash Can  
at the Senior high school in Serang

Sanitation facilities Trash Can	Number	Percentage (%)
Eligible	22	42.3
Not eligible	30	57.7
Total	52	100

Results *Table 6* above, from the 52 of the Senior high school in Serang found, schools that have qualified sanitation facilities trash can were 22 schools (42.3%) and the rest was unqualified as much as 30 schools (57.7%). Trash sanitation facilities in high school in Serang, the school that had qualified trash can were 22 schools (42.3%) and the rest which unqualified were 30 schools (57.7%). The proportion of trash sanitation facilities at Senior high school still deficient / unqualified in health, like their shelter trash (trash transported directly out of the school environment including those brought to the landfill compost), transporting waste transported directly every day, while the distance of garbage disposal from nearby classrooms (> 10 m or no because transported directly outside the school), the location of the last waste disposal from clean water sources (> 10 m or no because transported directly outside the school), so it will impact of diseases associated with the vector diseases such as flies, mice and cockroaches, such as diarrhea, dysentri, typhoid and herpes. Meanwhile, according to the meaning, trash can is a place to store temporary trash, after trash generated, which must exist in each source / trashmaker. Trash is closely related to public health because of those trashes will live many disease-causing microorganisms (bacterial pathogens) and also animals insects as a mover / spreader of disease (vector). Therefore, the waste must be managed properly to the smallest possible not to disturb or threaten public health. (Ministry of Health, Republic of Indonesia, 1999).

#### 7. Overview of sanitation of SPAL facilities at Senior high school in Serang

Table 7  
Frequency distribution of sanitary facilities of sewerage

Sanitation facilities of SPAL	Number	Percentage (%)
Eligible	22	42.3
Not eligible	30	57.7
Total	52	100

Results *Table 7*, from 52 of Senior high school in Serang, schools that have qualified sanitation facilities of sewerage were 22 schools (42.3%) and the rest that unqualified were 30 schools (57.7%). The proportion of high school sanitation facilities of sewerage (SPAL) at the Senior High

School found that there were some unwell, were SPAL sanitation facilities but has not filled up the health requirements including SPAL cemented, covered, flowing smoothly, Waste Water Disposal (channeled to recharge wells were closed), the distance of storage of waste water with clean water source ( $\geq 10\text{m}$  / PAM). Thereby potentially be a vector breeding sites of mosquitoes that can cause diseases such as dengue fever. So it can have an impact on the health of school children.

Sewerage Facility (SPAL) is a building that is used to remove and collect the waste water from the shower, kitchen sink, etc. except stool. So that the water is stored or pervasive and not become a breeding (breeding places) mosquito vectors, especially Culex mosquitoes and contaminate surface water and soil. For that, it needs to be a system of household waste water infiltration that shape and simple technical implementation. If the disposal of waste water throw to any place or do not use one type of SPAL that recommended with the health requirements it will contaminate ground, surface water and groundwater in addition it will also cause the soil becomes moist so that the worm eggs can survive longer and transmit to humans through food or direct contact with contaminated soil that causes a person wormy. (Kusnoputranto, 1997)

**8. The description of yard, grounds and Field at the senior high school in Serang**

Table 8  
Frequency Distribution yard, grounds and Field  
at the senior high school in Serang

yard, grounds and Field	Number	Percentage (%)
Eligible	0	0
Not eligible	52	100
Total	52	100

from the Results of *Table 8* above, it showed that from 52 of Senior high school in Serang, 100% no qualified schools have yards, grounds and Field. The average of the high school located in Serang City has a land as a yard, field and ground plants are not neatly arranged, and still looks rubbish everywhere, also the lack of use of land for crops (pharmacy) while the yard, the grounds and the field is part of the healthy school life environment, both physically, mentally, socially and environmentally, and this is one of the main programs of School Health Enterprises (TRIAS UKS), so this can be a media for school children caused diseases related to bad weather conditions such as ISPA and vector-based diseases. While the school environment is an institution that can protect students and school staff from accidents and diseases and to improve prevention activities and develop attitudes towards risk factors that can cause disease (Health Department, 2008)

**9. Overview on UKS corner at Senior highschool in Serang**

Table 9  
Frequency distribution of UKS corner at Senior high school in Serang

UKS corner	Number	Percentage (%)
Eligible	0	0
Not eligible	52	100
Total	52	100

Results of *Table 9* showed that from 52 of Senior high school in Serang, there were no qualified school that have UKS Corner.

With the UKS corner in every school so the school has participated in the implementation of the program corresponding with the UKS program constitution No. 36 of 2009 on Health, part of the 8th Article 79 paragraph (l) mentioned, school health organized to enhance the ability of learners in healthy living environment so the students can learn, grow, and thrive in harmony and as high as possible to become more quality human resources.

10. Description of the availability of the dangers of smoking posters in schools at Senior high school in Serang

Table 10  
Frequency distribution of the dangers of smoking posters availability Schools at Senior high school in Serang

Availability poster dangers of smoking	Number	Percentage (%)
Eligible	15	28.8
Not eligible	37	71.2
Total	52	100

The Results of *Table 10* showed that from 52 of Senior high school in Serang, the availability of the dangers of smoking in schools that qualified were 15 schools (28.8%) and unqualified were 37 schools (71.2%), Meanwhile the availability of smoking dangers in schools is one component in the UKS program with minimal strata development of healthy school environment.

11. Description of the Availability posters dangers of drugs at Senior high school in Serang

Table 11  
Frequency Distribution of the Availability of drugs dangers posters at Senior high school in Serang

Availability of poster dangers of drugs	Number	Percentage (%)
Eligible	4	7.7
Not eligible	48	92.3
Total	52	100

The Results of *Table 11* showed that from 52 of Senior high school in Serang, the availability of posters dangers of drugs in schools that qualified were four schools (7.7%) and the unqualified anti-drug poster were 48 schools (92.3%). there is a kind of knowledge expected in the visualization of information to school children about the dangers of drugs because the availability Poster dangers of drugs in school is one of the components in the UKS program with minimal strata development of healthy school environment.

12. Description of Supervision on school's shop / canteens at Senior high school in Serang

Table 12  
Frequency Distribution Control of school's shop / canteens at Senior high school in Serang

Supervision of the school shop/canteen	Number	Percentage (%)
Eligible	2	3.8
Not eligible	50	96.2
Total	52	100

The results of *Table 12* showed that the supervision of the shop / canteen in 52 senior high schools in Serang that qualified were 2 schools (3.8%) and the unqualified were 50 schools (96.2%). the absence of routine surveillance conducted by (Health Cadre School, UKS Teachers Trustees, Officers of Health), Presentation of food sale (all presented in a closed place and all wrapped food), food packaging (manufacturer) sold (labeled / permission from BPOM / Health Department, the undamaged packaging, has not expired), food and beverages that sold there contain prohibited dyes, no sticky sweet foods or soft drinks. Thus it needed for and development of the UKS development that can be monitored on the food ingredients who consumed by school children to avoid the danger of such materials or food poisoning.

13. Description of the implementation of mosquito nest and larvae eradication activities (3M Plus 1 time a week) at the Senior high school in Serang

Table 13

Frequency Distribution implementation of mosquito nest and larvae eradication activities (3M Plus 1 time a week) at the Senior high school in Serang

<b>PSN activities activities (3M Plus 1 time a week)</b>	<b>Number</b>	<b>Percentage (%)</b>
Eligible	13	25
Not eligible	39	75
<b>Total</b>	<b>52</b>	<b>100</b>

The results of Table 13 showed that the implementation of nest and mosquito larvae eradication activities (3M Plus 1 time a week) from 52 of Senior high school in Serang City, which qualified were 13 schools (25%), and that they were not conducting 3M plus 1 times a week a total of 39 schools (75 %), there were still many schools were not covering the cistern (TPA). Not doing depletion in the bath once a week, and did not backfill on secondhand items such as cans, old tires, etc.). So it can have a major impact on the high incidence of Dengue Fever (DHF) in schools, especially at Senior high school in Serang city.

14. Description of the shop / school canteens ownership at Senior high school in Serang

Table 14

Frequency Distribution of shop / school canteens ownership at Senior high school in Serang city

<b>Shop/canteen ownership</b>	<b>Number</b>	<b>Percentage (%)</b>
Eligible	1	1.9
Not eligible	51	98.1
<b>Total</b>	<b>52</b>	<b>100</b>

The results of Table 14 showed that ownership of School Shop / Cafeteria which eligible found that from 52 of senior high school in Serang city was 1 (1.9%) and the rest were unqualified were 51 schools (98.1%). The amount of ownership of school shop / canteen that is not in suitable with the provisions was that layout Canteen not directly associated to KM / WC, Distance  $\geq 20m$  of temporary garbage / there was no trash temporary garbage because transported directly, free of insects (flies are not found at all) , no dust walls, floor cleaner, arrangement of tables, chairs, cookware and arrangement of food sold neat, hand washing, trash, food equipment washing facilities, a presentation / cover food, foods that are sold contain a source of carbohydrates, protein sources , sources of vitamins and minerals (vegetables and fruits), so if the school does not have a shop or canteen healthy then the potential to impact on the health of school children related to food consumed.

15. Frequency Overview of UKS Program With Minimal Strata about healthy school environment at senior high school in Serang city.

Table 15

Frequency Distribution of UKS Program With Minimal Strata about healthy school environment at Senior high school in Serang city.

<b>Shop/canteen ownership</b>	<b>Number</b>	<b>Percentage (%)</b>
Eligible	0	0
Not eligible	52	100
<b>Total</b>	<b>52</b>	<b>100</b>

The Results of Table 15 showed that from 52 of Senior high school in Serang city, 100% UKS Program With Minimal Strata about healthy school environment at school no one qualified, this showed that they have not achieved the goal of UKS was to improve the quality of education and learning achievement of learners to improve clean and healthy behavior as well as the health of students and create a healthy environment, thus allowing the growth and development that harmonious and optimal in order to establish complete Indonesian man. (Ministry of Health, Republic of Indonesia, 2008).

16. Ownership of Worship Place at Senior high school in Serang city

Table 16

**Frequency Distribution of Worship Place at Senior high school in Serang city**

Ownership of worship place	Number	Percentage (%)
Eligible	41	78.8
Not eligible	11	21.2
Total	52	100

The results of Table 16 showed that from 52 of Senior high school in Serang City, the ownership of qualified worship place were 41 schools (78.8%) and the rest which unqualified were 11 schools (21.2%), in some Senior high school in Serang, worship place was a top priority, training and further development focused on improving the use and maintenance of the worship place for school children are expected to create a healthy environment, allowing the growth and development of harmonious and optimum in order to establish complete Indonesian man. (Ministry of Health, Republic of Indonesia, 2003).

### CONCLUSION

Application Development of Healthy School Environment Activity at Senior high school in Serang city, based on the results of the study showed that the school has Healthy School Environment Development activities were 17 schools (32, 7%) and schools that did not have a healthy school environment development activities were 35 schools (67, 3%), it can be illustrated that a healthy school environment development activities in Senior high school in Serang city has not been implemented optimally, the quality and intensity of health education on the importance of a healthy environment of Serang City Health Department in particular holder is in place in the school through the school principal approach, teachers UKS and adolescent health cadres should be increase more.

### ADVICE

For Local Government Department and Related agency There needed for guidance from the Executive of UKS Team and real Healthy School Competition in stages.

Provision of programs and budgets in the implementation of School Health Unit (UKS) including the provision of budget in the form of grants for the implementation of the School Health Unit program (UKS)

Subsequent research Further research on coaching and development of the UKS on health education aspects of, health care, energy, infrastructure, research and development, management / organization, monitoring and evaluation.

### BIBLIOGRAPHY

- Notoatmodjo, S. (2005). *Metodologi Penelitian Kesehatan*, (Third Edition). Rineka Cipta: Jakarta.
- Notoatmodjo, S. (2007). *Kesehatan Masyarakat Ilmu dan Seni*, (First Edition). Rineka Cipta: Jakarta
- Sumirat, J. (2004). *Kesehatan Lingkungan*, Erlangga: Jakarta.
- Surasetja, A. (1988). *Perkembangan Ilmu Kesehatan Masyarakat Dasar di Indonesia*. Publisher, Bhatara: Jakarta.
- Departemen Kesehatan RI, (2008). *Pedoman Pelatihan Dokter Kecil*, Jakarta.
- Departemen Kesehatan RI, (2007). *Pedoman Untuk Tenaga Kesehatan UKS Di Pondok Pesantren*, Jakarta.
- Departemen Kesehatan RI, (2003). *Pedoman Untuk Tenaga Kesehatan Usaha Kesehatan Sekolah Di Tingkat Sekolah Lanjutan*, Jakarta
- Kementerian Kesehatan RI, (2010). *Rencana Strategis (RENSTRA) Kementerian Kesehatan Tahun 2010 - 2014*, Jakarta.



- TP UKS Provinsi Banten, (2010). *Pedoman Pembinaan dan Pengembangan Usaha Kesehatan Sekolah*
- Departemen Kesehatan RI, (2008). *Petunjuk Teknis Penjaringan Kesehatan Anak Sekolah*, Jakarta
- TP UKS PUSAT, (2008). *Keputusan Bersama Menteri Pendidikan Nasional, Menteri Kesehatan, Menteri Agama dan Menteri Dalam Negeri RI*, Jakarta.
- STIKes FA, (2011). *Pedoman Penyusunan Tugas Akhir Mahasiswa STIKes FALETEHAN*. Serang.
- Kementerian Kesehatan RI, (2009). *Undang-Undang Republik Indonesia Nomor 36 Tahun 2009*. Jakarta.
- Health department of Serang City, (2010). *Profil Kesehatan Kota Serang Tahun 2009*. Serang
- Health department of Indonesia, (2008). *Promosi Kesehatan Di Sekolah*, Jakarta.
- Health agency of Banten province, (2010). *Profil Kesehatan Tahun 2010*, Serang.

# **THE EFFECTIVENESS OF AIRPLANE FLYING IN IMPROVING STUDENTS' SPEAKING ABILITY (AN EXPERIMENTAL STUDY AT ENGLISH DEPARTMENT OF STKIP BINA BANGSA GETSEMPENA)**

Regina Rahmi, Rahmi Fhonna & Sri Wahyuni

Aceh Besar, regina\_sadica@yahoo.com, +6281360003382

Banda Aceh, rahmi\_fhonna@yahoo.com, +6281360600417

Aceh Besar, sr1e82@yahoo.co.id, +628126954082

The success of teaching and learning foreign language skills, especially in English is determined by a number of factors such as students, teachers, teaching methods, techniques, and instructional media. New Model in English language teaching is needed to create new atmosphere to motivate the student in learning process. The researchers believe that cooperative learning is the appropriate way to teach students to gain better in speaking. Therefore, the researchers created airplane flying model.

This study was conducted at English Department of STKIP Bina Bangsa Getsempena in order to investigate the effectiveness of using airplane flying model in improving the students' speaking ability. The experimental study was used as the design of this research with 48 students as the sample. The data were collected by using pre-test and post-test. The result showed that the students were very interested in using the airplane flying model as it challenged them to stimulate their ideas to produce a good speaking.

The technique of data analysis is using T-test. It can be concluded that the difference between the two means is significant. By those facts,  $H_0$  is rejected and  $H_a$  is accepted. Thus, Airplane Flying is effective in improving the students' speaking ability.

## **1. Introduction**

### **1.1 Background**

As one of the skills needed in mastering English, speaking is very important to convey the message orally. Many students claim that speaking is the hardest skill to be mastered since it requires clear pronunciation, correct grammar, and proper vocabulary used. These aspects, eventually, are essential due to both speakers have to understand each other when the communication takes place; otherwise, they are failed to convey the message. Hybels (2001: 22) explains that speaking is a communication tool where the people may share any information, ideas and feelings.

In terms of the tertiary level of education, the need of speaking skill even more complex. The students are expected to be able to speak academically and they should recognize the words chosen to produce better language. Therefore, many aspects should be noticed by the students when they are in a communication process, such as linguistics aspect including word, phrases, and sentences used to convey the message for the listener (Siahaan, 2008: 95). This implies that the educational success entails the ability to articulate the thoughts obviously.

In order to encourage the students' achievement in speaking, various techniques and models of teaching can be applied; one of those is the airplane flying model. This model is almost similar to the snowball throwing one, but the airplane flying model is more challenged since its volume is thinner than the snowball one. Therefore, the students should pay more attention when they practice the airplane flying model; otherwise they cannot reach the target they are expected. However, this model of teaching is very motivating to be pertained in teaching process in order to stimulate the students' ideas to improve their speaking ability. This study, hence, has an attempt to carry out a new model of cooperative learning; the airplane flying model whether it improves the students' speaking skill.

### **1.2 Research Problem**

In order to highlight the accuracy of the use of one of the cooperative learning models, the problem of this research can be stated as in the following: Is airplane flying model effective in improving students' speaking skill?

## **1.3 Research Objectives**

The purpose of this research is to investigate the effectiveness of using airplane flying model in improving the students' speaking skill.

## **2. Literature Review**

### **2.1 Speaking**

Speaking is the process of building and sharing meaning through the use of verbal and non-verbal symbols, in a variety of contexts. (Chaney,1988,13). Nowadays, the world requires communicative skills, because, only in that way, students can express themselves and learn how to follow the social and cultural rules appropriate in each communicative circumstance. It can say that teaching speaking is very important for the students. Therefore, the teacher should teach them to master all elements of speaking, in order to make the students capable in speaking English fluently in their daily conversation.

#### **2.1.1 The Element of Speaking**

Here, the writer would like to explain about the elements of speaking stated by Harmer (2001: 269-276). They are:

1. Language features, included: a) connented speech, b) expressive device, c) lexis and gramma, and d) negotiation.
2. Mental processing, included: a) language processing, b) interacting with other, and c) on the spot information processing

#### **2.1.2 Speaking as a Skill**

Speaking is commonly performed in face-to-face interaction and occurs as a part of a dialogue or a form of verbal exchange and it depends on an understanding of what has been said in the interaction. The word dialogue itself has been variously used. Dialogue is a kind of way in which two people talk face to face, with the view to maintain personal equation and social solidarity.

If we think about how we use our first language, then it is obvious we spent most of our time using sentences, and very little of our time reviewing our knowledge or trying to compose perfect sentence. We would find it most difficult to describe and explain all the decisions we make when we speak. Therefore, knowledge is only a part or the affair; we also need skill. What is difference between knowledge and skill? A fundamental difference is that while both can be understood and memorized, only a skill can be limited and practiced.

#### **2.1.3 Principles for Teaching Speaking Skills**

There are some principles for teaching speaking skills. According to Brown (2001: 331-332)sated the principles for teaching speaking skills into some catagories, they are: 1) focus on both fluency and accuracy, depending on your objective,2) provide intrinsically motivating techniques,3) encourage the use of authentic language in meaningful contexts, 4) provide appropriate feedback and correction, 5) capitalize on the natural link between speaking and listening, 6) give students opportunities to initiate oral communication, and 7) encourage the development of speaking strategies.

#### **2.1.4 Responsive Speaking Assessment**

Responsive speaking refers to a learner's ability to participate in very simple and brief interactions with another person, such as greetings, small talk and basic requests (Brown2000:145). To assess Responsive Speaking teacher should consider about scoring bellow.

**Table 2.1 The Scoring Responsive Speaking Assessment (Brown. 2000:145)**

NO	ASPECT	SCORE
1.	Pronunciation	20
2.	Intonation	20
3.	Grammar	20
4.	Vocabulary	20
5.	Fluency	20
	T o t a l	100

From the table it can be described that this assessment is scored after students' performance by focusing on Pronunciation, Intonation, Grammar, Vocabulary, Fluency and each aspect of the assessments will be scored 20 (twenty). If the students pronounce the words correctly, they will be scored by 20 points. In contrast, if the students use uncorrected pronunciation, so they will be scored by 0. Similarly, for the others aspects such as intonation, grammar, vocabulary and fluency it will be scored 20 points for the correct one and 0 for the uncorrected one.

## 2.2 Cooperative Learning

Brown and Ciuffetelli (2009:507) mentioned some benefits and applicability of cooperative learning, they are:

1. Students demonstrate academic achievement.
2. Cooperative learning methods are usually equally effective for all ability levels.
3. Cooperative learning is effective for all ethnic groups.
4. Student perceptions of one another are enhanced when given the opportunity to work with one another.
5. Cooperative learning increases self-esteem and self-concept.
6. Ethnic and physically/mentally handicapped barriers are broken down allowing for positive interactions and friendships to occur.

## 2.3 Airplane Flying

An airplane (informally plane) is a powered fixed-wing aircraft that is propelled forward by thrust from a jet engine or propeller. Airplanes come in a variety of sizes, shapes, and wing configurations. The broad spectrum of uses for airplanes includes recreation transportation of goods and people, military, and research (Wikipedia, 2014).

But on this research, the airplane that used in teaching speaking made of the paper/origami which created according to the pattern or frame.

## 3. Research Methodology

### 3.1 Research Design

The design of this research was quasi-experimental study (time series design). Quasi-Experimental design which consisted only experimental class without control class design with quantitative approach because it is intended to investigate the effectiveness of using airplane flying model in improving students' speaking ability. In this study the experimental design used is One-Group Pretest-Posttest. The one group design usually involves three steps:

1. Administering a pretest measuring to dependent variable
2. Applying the experimental treatment to the subject
3. Administering a posttest again measuring the dependent variable

This design can be summarize as follow:

Pre-test Y <sub>1</sub>	Treatment X	Post-test Y <sub>2</sub>	1
----------------------------	----------------	-----------------------------	---

### 3.2 Sample

The sample of this research was the even semester students of English Department of STKIP Bina Bangsa Getsempena. It consisted of 48 students and divided into three even semesters, those are Second Semester, Fourth Semester, and Sixth Semester.

### 3.3 Data Analysis

In this study, quantitative data was used that taken from the students' speaking score on pre-test and post-test. Then the result of score both classes were compared by using t-test to find out if there is significant difference of the students' performance after they were taught using airplane flying model. Pre-test was taken before doing the experimental study or before teaching by using airplane flying model. The second was post-test; it was taken after doing an experimental study or after airplane flying model applied. Technique of data analysis was the way data were analysis by the researchers. The technique of data analysis in this research was quantitative data analysis and will analyze statistically by using t-test. The formula of pre-test and post-test one group design t-test as follows: (Arikunto, 2002:275)

$$t = \frac{Md}{\sqrt{\frac{\sum x^2 d}{N(N-1)}}}$$

2

Notes:

Md = Mean of the different between pretest and posttest (posttest – pretest)

Xd = Deviation of every subject (d – Md)

$\sum x^2 d$  = Total of square deviation

N = Subject on the sample

d.b. = N – 1

## 4. Research Finding and Discussion

The result of the research showed that the students experienced an advanced skill in speaking. This can be seen from the result of their pre-test and post-test illustrating the highly developed score. All students from 3 (three) different groups acquired various range of score as can be seen in the following sections.

### 4.1 Research Finding

#### 4.1.1 The result of Pre-Test

**Table 4.1 The students' pre- test score of group 1**

Initial	Students' Identity Number	Pre - test score
FA	1311060003	(71)
KH	1311060007	(87)
MUI	1311060009	(86)
OL	1311060011	(72)
RG	1311060013	(87)
RL	1311060014	(72)
RTU	1311060015	(84)
SS	1311060016	(83)

SA	1311060017	(84)
TAW	1311060018	(86)
GAS	1311060004	(86)

The table above showed the detail of the students' pre-test of group 1 in which KH and RG obtained the highest score, 87. 86 is the second highest score in this group which was achieved by 3 students; MUI, TAW and GAS. RTU and SA got 84 meanwhile both OL and RL's score were 72. However, there was only 1 student attained the lowest score 71, FA. Overall, the students performed a good quality of speaking skill reflecting their ability in understanding the topic.

**Table 4.2 The students' pre-test score of group 2**

Initial	Students' Identity Number	Pre - test score
CN	1211060002	(84)
CE	1211060003	(82)
CIZ	1211060004	(82)
KH	1211060007	(83)
MH	1211060009	(84)
MAS	1211060010	(83)
RH	1211060015	(86)
RAS	1211060016	(70)
RD	1211060017	(83)
RA	1211060018	(87)
YA	1211060022	(83)
LR	1211060024	(86)
MW	1211060026	(84)
SN	1211060031	(81)
HB	1211060036	(69)

From the above table, it can be seen that most students obtain very good score in speaking. Similar to the group 1, 87 was also the highest score achieved in this group that was obtained by RA. 2 students; RH and LR got 86 and 3 students acquired 84. The other students, in addition, attained 83 by 4 students, 82 by 2 students, 81 by 1 student and 70 by 1 student as well. HB, nevertheless, experienced the lowest score of speaking in this group stood at 69.

**Table 4.3 The students' pre-test score of group 3**

Initial	Students' Identity Number	Pre - test score
AG	1111060001	(89)
FY	1111060003	(79)
NH	1111060004	(80)
AG	1111060006	(80)
IA	1111060008	(83)
JF	1111060010	(80)
KH	1111060011	(79)
IS	1111060012	(80)
EL	1111060013	(83)
MW	1111060014	(84)
NZ	1111060019	(75)
DB	1111060022	(75)

NH	1111060023	(90)
NV	1111060024	(81)
UA	1111060025	(75)
IPA	1111060026	(87)
ZF	1111060028	(80)
BH	1111060033	(75)
KL	1111060034	(80)
ZY	1111060035	(82)
MA	1111060036	(90)
EYN	1111060021	(60)

The table above represented the score of pre-test from the students of group 3 clearly. The range of score spread variously in which 90 was the highest score achieved in this group by NH and MA. However, EYN obtained the lowest score in this period which was 60. The other students experienced a variety range of score, starting from 75 up to 89. It can be seen that 4 students; NZ, DB, UA and BH, accomplished 75. 2 students; FY and KH, additionally, got 79, followed by NH, AG, IS, ZF and KL who obtained 80. Then, NV and ZY got 81 and 82 each for their pre – test score. 2 students; IA and EL should be satisfied with 83, and MW had 84 for his pre – test score. The rest students, JF, IPA and AG, each of them achieved 86, 87 and 89 consecutively.

#### 4.1.2 The result of Post-test

**Table 4.4 The students' post-test score of group 1**

		The post-test score
FA	1311060003	B (73)
KH	1311060007	A (89)
MUI	1311060009	B (85)
OL	1311060011	B (76)
RG	1311060013	A (90)
RL	1311060014	B (77)
RTU	1311060015	A (88)
SS	1311060016	A (86)
SA	1311060017	A (90)
TAW	1311060018	B (85)
GAS	1311060004	-

Having reviewed the students' post test score in group 1, it can be concluded that the students improved their speaking ability since the score increased considerably. In this test, 2 students (RG and SA) achieved the highest score 90. KH and RTU obtained 89 and 88 each, meanwhile SS got 86. Both MUI and TAW acquired 85 for their post test score in speaking by using the airplane flying model. RL, OL and FA had 77, 76 and 73 in this test. GAS, unfortunately did not participate in this post-test. Indeed, all students experienced a significant change in their speaking skill.

**Table 4.5 The students' post-test score of group 2**

		The Post-test score
CN	1211060002	A (87)
CE	1211060003	A (86)
CIZ	1211060004	A (87)
KH	1211060007	B (85)
MH	1211060009	B (82)

MAS	1211060010	B (85)
RH	1211060015	A (90)
RAS	1211060016	B (73)
RD	1211060017	B (81)
RA	1211060018	A (90)
YA	1211060022	A (87)
LR	1211060024	B (85)
MW	1211060026	A (88)
SN	1211060031	B (85)
HB	1211060036	B (73)

The students' post-test score in group 2 also portrayed similar changes as the students in group 1 did, comparing to the score of pre-test. 90 was the highest score in this test which was obtained by RH and RA. MW had 88 for her post-test score; CN, CIZ and YA acquired 87 each. Only CE had 86, meanwhile KH, MAS, LR and SN achieved 85. The other students; MH and RD got 82 and 81 each. On the other hand, RAS and HB had the lowest score, 73 for their post-test.

**Table 4.6 The students' post-test score of group 3**

Initial	Students' Identity Number	The Post-test score
AG	1111060001	A (92)
FY	1111060003	B (82)
NH	1111060004	B (85)
AG	1111060006	A (86)
IA	1111060008	A (93)
JF	1111060010	B (85)
KH	1111060011	B (82)
IS	1111060012	C (70)
EL	1111060013	B (80)
MW	1111060014	A (87)
NZ	1111060019	B (77)
DB	1111060022	B (77)
NH	1111060023	A (92)
NV	1111060024	A (86)
UA	1111060025	B (73)
IPA	1111060026	A (95)
ZF	1111060028	B (84)
BH	1111060033	B (77)
KL	1111060034	B (83)
ZY	1111060035	B (84)
MA	1111060036	A (97)
EYN	1111060021	C (65)

Comparing to the other 2 groups, the students in group 3 developed their speaking ability significantly. This can be seen from the above table demonstrating their post-test score. MA had the highest score which was 97, followed by IPA and IA with the score of 95 and 93 each. AG and NH obtained 92 for their post-test, meanwhile MW had 87. 2 students; AG and NV achieved 86, and 2 other students; NH and JF had 85. Furthermore, ZF and ZY got 84 for their post-test and KL had 83.



The score of 82 was obtained by FY and KH, and EL had 80. 3 students; NZ, DB and BH acquired 77 in this test, UA got 73 and EYN had the lowest score in this score which was 65.

## 4.2 Research Discussion

Having calculated a mean score of the pre-test result the difference between these mean scores was compared by employing an independent sample t-test. According to the means of the pre-test scores, it was found that the mean of the pre-test scores is 55,14. The post-test results was 80,33. It can be assumed that the differences between two means are significant since the t-test exceed the t-table. Therefore, the null hypothesis (Ho) is rejected and consequently the hypothesis alternative (Ha) is accepted by means the airplane flying model used achieve the students a better performance in speaking. In fact, the airplane flying model has encouraged the students to get better achievement because it fulfills the students have time to focus on both fluency and accuracy during the lesson.

## 5. Conclusion

Based on the theories, findings, and discussion explored in the previous section, the conclusion can be drawn as the  $t_{count}$  exceeds  $t_{table}$  the alternative hypothesis (Ha) is accepted and the null hypothesis is rejected, it means that there is different speaking score of the third even semester student of English department of STKIP Bina Bangsa Getsempena. It is clear that the used of airplane flying model is effective in improving students' speaking skill. The students' ability in speaking had improved by using the new cooperative learning model, airplane flying model. It is also showed by the achievement of the third even semester of STKIP Bina Bangsa Getsempena in learning Speaking using airplane flying model that increases gradually.

There are some suggestions proposed both for further research and for practical purposes. The suggestions are intended to enhance and find the best technique or model in teaching speaking. The lecturers of speaking subject should improve their teachings methods and manage good atmosphere class in order to stimulate and motivate the students in learning English speaking more seriously such as by using airplane flying model. The lecturers of speaking should give much attention to the students' speaking aspect; they should continue to give assignment, or exercise such as dialogue (conversation) or discussion and debate. The students should spend much time to build up the discussion and debate about the issues to improve their speaking ability.

## REFERENCES

- Brown, H., & Ciuffetelli, D.C. (Eds.). (2009). *Foundational methods: Understanding teaching and learning*, p. 508. Toronto: Pearson Education.
- Brown, Douglas H. (2007). *Teaching by Principles: An Interactive Approach to Language Pedagogy*. Pearson Education, Inc., New York, P.390
- Brown, H. Douglas. (2001). *Teaching by Principles; An Interactive Approach to Language Pedagogy- 2<sup>nd</sup> ed.* San Francisco State University: Addison Wesley Longman, Inc.
- Chiu, M. M. (2000). [Group Problem Solving Processes: Social Interactions and Individual Actions.](#) Journal for the Theory of Social Behavior, 30, 1, 27-50.600-631.
- Collin, William. (2009), *Colling English Dictionary-Complete and Unabrigde*, Wilian Collins Sons & co. Ltd.
- Hammil, Donald D. (1975). *Teaching Children with Learning and Behaviour Problems*, Boston, MA, USA: Allyn and Bascon.
- Harmer, Jeremy. (1991). *The Practce of English Language Teaching*, Longman, New York.
- Harmer, Jeramy, (2001) *The Practice of Language Teaching*, England: Longman,
- Hybels, R. (2001). *Speaking as a skill*. Philadelphia: Routledge.
- Johnson, D. W.& Johnson, R. T.(1989). *Cooperation and competition: Theory and research*. Edina, MN: Interaction Book Company.
- Kagan, S. (1990). *The Structural Approach to Cooperative Learning*. Educational Leadership, 47(4), 12-15.
- Nunan, D. 1999. *Second Language Teaching and Learning*. University of Hongkong, Henle and Henle Publisher.
- Richard, Jack. C., John T. Platt, Heidi Weber. (1985). *Longman Dictionary of Applied Linguistics*, Michigan: Longman, University of Michigan.

- Rivers, Wilga M. 1981. *Teaching Foreign Language Skill*. Chicago: The University Press.
- Ross, J., & Smythe, E. (1995). *Differentiating cooperative learning to meet the needs of gifted learners: A case for transformational leadership*. *Journal for the Education of the Gifted*, 19, 63-82.
- Schiller, Andrew. (1973). *Language and How to Use It*. Illinois.
- Siahaan, S. (2008). *Issues in Linguistics*. Yogyakarta: Graha Ilmu.
- Slavin, R. E. (1990). *Cooperative Learning*. New Jersey: Prentice-Hall.
- Tsay, Mina & Miranda Brady (June 2010). "A case study of cooperative learning and communication pedagogy: Does working in teams make a difference?". *Journal of the Scholarship of Teaching and Learning*. 2 **10**: 78–89.
- Wikipedia (2014). Airplane. Retrieved from <http://en.wikipedia.org/wiki/Airplane> May 4, 2014.

## GRAND DESIGN OF MARINE BASED CURRICULUM FOR EARLY CHILDHOOD EDUCATION IN THE PROVINCE OF GORONTALO RUSLIN BADU

Gorontalo State of University, [ruslin\\_badu@yahoo.com](mailto:ruslin_badu@yahoo.com), 085256499020

### Abstract

Human resource development program through early childhood education is a program that should be done immediately. This expected to accelerate the Gorontalo province government's policy of access for community services.

The problem is how the conceptual model, how the implementation, and how the effectiveness of the grand designs of marine-based curriculum. The aim to set the initial conditions of the grand design of the marine-based curriculum preparing conceptual models of the grand design of marine-based curriculum, implement the model grand marine-based curriculum design, Test the effectiveness of the model grand marine-based curriculum design. Method of research used *research and development* by Borg and Gall

The result (1) lack of understanding and skills of early childhood educators about the potential use of marine activities for play and learning activities. (2) the gap between understanding and condition of existing skills with the understanding and skills that should be possessed educators ideal as the person responsible for implementing the curriculum. (3) the average understanding and skills of educators increased significantly after attending workshop, (4) the motivation of educators to educate early childhood for the better, (5) grand design of marine-based curriculum developed shows effective improve the understanding and skills of early childhood educators.

**Key word :** *Grand Design, curriculum, Marine based, Early Childhood educators*

## Introduction

Gorontalo province as one of the youngest in Indonesia have various problems related to quality education of children at an early age. A lack of access services related to its limited infrastructure to be an obstacle in raise the quality of teaching for children at an early age. Of the total number of children at an early age  $\pm$  65% of children have not been reached by good education services the kindergarten, the play group, or education a kind, furthermore, the low participation in the event early child education also became the trigger for the low quality.

Design Marine-Based Curriculum for teachers ECD in Gorontalo Province will be done because Gorontalo province as youngest in Indonesia, put the increase the quality of life as a program. Many problems that are related to human resources development, we will need efforts synergy and relevant to this problem does not have a wider impact on the life of society as a whole. Human resource development program early child education through is a program that must be done immediately. With education, is expected to speed up the government policy Gorontalo province in the service access to move ahead.

From identification result introduction, choose Grand Design Marine-Based Curriculum For Teachers ECD in Gorontalo Province based on several Directors are:

1. As the effort broadening access early child education in accordance with the potential areas
2. Early age children To increase their creativity in accordance with potential.
3. A source of learning that needed to carry out the various activities skills in order to improve Early Age Children intelligence
4. Terjangkaunya education for children age 0 to 6 years
5. Involvement of communities in the event early child education.

Formulation of problems, How model grand design marine-based curriculum for teachers ECD in Gorontalo Province. In particular the problem can be formulated as follows: **(1)** How the condition early grand design marine-based curriculum in Gorontalo Province, **(2)** How model conceptual grand design marine-based curriculum in Gorontalo Province, **(3)** How implementation of grand design marine-based curriculum in Gorontalo Province, **(4)** How effectiveness grand design marine-based curriculum in Gorontalo Province?

Network is one of 10 integrated approach to learning methods projects. Every day children learning approach will be given develop expertise that will be brought to project activities, such as the bazaar food, a visit to the port, a visit to fish, a visit to the fishing nets. In addition to its visit, learning experience given to bring some source or the experts in the in such as for the conservation coral reefs bring resource person from UNG in a marine conservation matters coral reefs. Learning activities carried out in central centers in accordance with expertise that will be developed to realize that are being planned. Development on internalised in every development activity basic skills. For example projects for children is the bazaar processed fish.

Table 1 Early Child Development characteristic 2-6 years

Aspects of development	Age 2-3	Ages 3-4	Age 4-5	Age 5-6	
<b>The values of religion and morality</b>	-Began to imitate prays/movement ... -Began to imitate a-do'a and letters from the debt -Began to understand when a hearty,thank you, I am sorry,etc.	Began to understand the lawanan although it has not yet Southern Arabia would most frequently come across as always ny. understanding on both the worst, is one, polite,- indelicate	to the know God - Imitate serve movement -Speak a after and before do something -Know good behavior and polite -Getting diriberprilaku good acted very modestly good -Giving salam and give peace	-Started to get to know God - Imitate serve movement -Speak a after and before do something -Know good behavior and polite -Getting diriberprilaku good acted very modestly good -Giving salam and give peace	-To know religion that really incorporates -Are accustomed to worship -Understand noble behavior (honest,protectors, polite respect,etc. ) -Distinguish good behavior and principles -Know rituals, and great day religion -To respect the religious others

<b>Motorical physic</b>	<ul style="list-style-type: none"> <li>-Climb with true</li> <li>-Up and down stairs sometimes is still supported</li> <li>-Started to kicking ball outlook</li> <li>-Ran slowly</li> <li>-Cycling wheel three</li> <li>Can bend feet without falling</li> </ul>	<ul style="list-style-type: none"> <li>-Can jump and stand with one foot in the last 5 seconds</li> <li>-Up and down stairs without assistance</li> <li>-Kicking ball straight forward</li> <li>-Can catch the ball</li> <li>-Move forward and backward without falling</li> </ul>	<ul style="list-style-type: none"> <li>-To stand with one foot in the last 10 seconds</li> <li>-Jumping</li> <li>-Swim and climb</li> <li>-Can do play rope</li> </ul>	<ul style="list-style-type: none"> <li>Body balance movement -do and coordinated to train the balance,flexibility, and agility</li> <li>-Imitated dance-exercise</li> <li>-Games physical with the rule</li> <li>-Skillfully using his right hand and the left-hand</li> <li>-Activities hygiene kits</li> </ul>
<b>Fine Motoric</b>	<ul style="list-style-type: none"> <li>-Can make a straight line vertical, horizontal, and the cycle</li> <li>-Leafing through books</li> <li>-Can arrange blocks and make the building of the six beam</li> <li>-Can hold writing utensils</li> <li>-Can open the borders open to the way shown</li> <li>-Can do nuts collages from</li> </ul>	<ul style="list-style-type: none"> <li>-Can apply different forms</li> <li>-Can and additions throughout its bar those with 2-4 parts of the body</li> <li>-Could have been cut off</li> <li>-Can re-picture a circle and square</li> <li>-Began to be able to set an example some form letter</li> <li>-Draw up a beam build appropriate imagination</li> <li>-Can coloring with crayons</li> <li>-Can make the building of sand</li> <li>-Can pour water into the basin various sizes without tum-pah</li> <li>-Has been able to wear clothes and sent among themselves, but still with zip up and big buttons</li> </ul>	<ul style="list-style-type: none"> <li>-Able to apply forms of geometry</li> <li>-Has been able to draw people with a complete</li> <li>-Can trace letters</li> <li>-Has been able to wear - half-hearted dress without helped</li> <li>-Should be able to use spoon-fork properly</li> <li>-Has already been stricken</li> <li>CHAPTERS and like himself without helped</li> <li>-Can be a card that is set dipapan</li> <li>-Can paint and doing fingerpainting</li> <li>-Can make a model of the clay</li> <li>-To build a complex structure by using beam</li> </ul>	<ul style="list-style-type: none"> <li>-Drawing according ideas</li> <li>-Imitate form</li> <li>-Buyback services with various media and events</li> <li>-Using paper in truth</li> <li>-Clip in the pattern</li> <li>-Attached picture with the right</li> <li>-Express themselves through a draw in detail</li> </ul>
<b>Cognitive</b>	<ul style="list-style-type: none"> <li>-Can make a play on form</li> <li>-Can match and connecting</li> <li>-Imagination developing countries and will be able to do pretending to be playing</li> <li>-Can be grouped some things based on shape and color</li> <li>-Unable to complete puzzle, consisting of 3-4</li> </ul>	<ul style="list-style-type: none"> <li>-Can play puzzle 4-5 pieces</li> <li>-Know a few colors</li> <li>-Memahami concept count some figures</li> <li>-Believes that problems only from one point of view</li> <li>-Began to have concern to the concept of time</li> <li>-Can follow 3 command</li> <li>-Can repeat again simple story</li> </ul>	<ul style="list-style-type: none"> <li>-Can count 10 or more objects</li> <li>-Can recognize 4 colors with true from one object</li> <li>-Can understand the concept of time with better</li> <li>-Know the things that are used every day</li> </ul>	<ul style="list-style-type: none"> <li>-Classify objects based on the function, color, shape and size</li> <li>-Show the activities that are eksploratif and researched (what would happen if the water spilled)</li> <li>-To draw up plans that will be</li> <li>-Know cause and effect on the environment</li> <li>-Shows the initiative to choose a theme</li> </ul>

	pieces -Understand the concept of "2"	-Understand the concept and different -She was happy to play fantasy		games -To solve the problem in daily life simple-to-day -Know the difference ukuranmengelompokkan objects -Know the pattern -Megurutkan objects based on size -Mention street connecting numbers 1-10
<b>English</b>	-Can follow 2-3 command -Can identify objects and images -Understand almost all his words -Has been using 4-5 words in his words -Can mention the name, age, and gender -Began to be able to use the word change -Words spoken has already started to understand his adversaries talk	-Understand the concept and different -Can tell a story -Can speak with basic grammar -Can talk to use 5-6 said in his words -Has spoken is quite clear and adult can understand the intent pembicarannya	-Can repeat the story that long-term -Spoke with more than 5 words in kalam -Can use the words "clear time -Able to tell a story with a long story -Able to mention the name and address	-Understand some of the orders in the same time -Repeat his words are more complex -Answering the question that more complex -Said that the figure that has the noise of the period -Have vocabulary that supports verbal communication and mengekspresi-Kan ideas -Menyusun complete structure with simple sentences -Continues to invest some story that has been pumped The symbols of - refers to a letter that known -Read name of their own -Writing name of their own -Understand relations between the sound and form letter - Call from Ariens images that have the sound/letter early period
<b>Social</b>	-Are able to engage in a game -Understand the concept has -Spontaneously show on friendly with friends	-Interested in the new experience -Can work together with other children -Pretending to be able to play (mrs.-ibuan) -Play fantasy grow -Increasingly more independent	-Provides the opportunity to play with friends -Want to other people -Easily agreed rules game -Happy activities related to the interest	-Has been cooperative with friends -Show a tolerant -Show empathy toward -Understand rules and discipline -Know good karma and polite social

			-More independent and can visit neighbors without being accompanied by	values in culture setempat menghargai superiority others
<b>Emotional</b>	-To start the emotion -Can easily part with the parents -Can follow changes the routine	-Imagine that the pictures foreign that weird is monster -Egocentric -Has not been able to separate between illusion and reality	-Began to consider the vast differences sex -Began to be able distinguish between a fantasy and reality -Sometimes easy to work together sometimes refused cooperation	-The emotions that in accordance with the conditions that are -Have persistent attitude -Proud of their own work
<b>Creativity.</b>	-To the emergence interests of children to berkreaitivitas through graffiti-line	-Works which are made from a lot of sense -Happy to keep, and you have seen his work	-Began to emerge ideas that are more complicated -Start munculminat to elaborate and elements creativity.	-Smooth -Flexibility -Originality -Elaboration -Keluletan -Patience

## Method

### Approach and Research method

To achieve the research that has been formulated, but this research method using approach research and development (*research and development*). To get a model for the teachers tervalidasi ECD to implement the marine-based curriculum in teaching. Then with analysis of kualitatif and quantitative. Procedures that have been taken by in this research based approach as in *research and development* (R & D) according to Borg and Gall ( 2003:569 ) explained that:

*Research and development is an industry-based development model in which the findings of research -- used to design new products and procedures, which systematically than -- field-tested, evaluated and refined until they meet specified criteria of effectiveness, quality, or similar standards.*

The goals *research and development* is to produce new products or improvement to the product for a long time for improving the skills and knowledge teachers in applying the curriculum-based advanced a marine also carry out tests an experiment to get a model final.

But in this research only in the activity to develop models end, not even in disseminating and socialization model. The ten steps mentioned above were divided into advanced to a few steps page, namely:

### A Study Introduction

In the activity study introduction will be done through the measures aimed to identify factors and brings together material (study literate) is consistent with the various models in accordance with a focus on research. By conducting a study introduction to the teacher in ECD where research, is a key data from the subject research. Industry data was collected and adjusted with a focus on problems or, in order to obtain conceptual models.

### Development of the Model Conceptual

In the development of the model conceptual through some of the activities as follows:

- a. Draft model. Among the resolute needs to be done is: designing a model hipotetik marine-based curriculum based on the result study objective sidelined, a field, the results study or passed away the relevant, analyzing gap between teachers ability to apply based curriculum marine in a lesson for the early age children with the ability to ideal as expected. Describing tearing based curriculum marine will be done on the basis of input professionals and experts, in a way to test the feasibility hipotetik curriculum that developed.
- b. Verification model hipotetik, activities included: (1) do validation "three lives" argument conceptual hipotetik model to the experts, (2) to Make feasibility varidasi model to practitioners in the field, (3) to Make a revised model, and is ready to be testing model a limited (test limited).

## Limited trial

This activity aimed to get evaluation early about new products. Evaluation is based on balikan, from scholars and practitioners; Carry limited testing models, to a small group teachers (3 persons). A revised/completion model, ready to be implemented in tests on/trial empirical.

## Implementation of Model (testing Field)

Aims to determine if the product that has been developed according to the plan can be carried out. In the implementation phase model activity was done is as follows:

- a. Implementation of model based curriculum marine will be done in the current *treatment*, through an experiment *quasi* with the activities as follows:
  - 1) Testing early kemampuan teachers about the application based curriculum marine prior to the holding of implementation through *pretest* imposed in the current *treatment* and controls.
  - 2) Conducted a workshop, to discuss a marine model based curriculum developed in the current *treatment*.
  - 3) Doing evaluation on the implementation of implementation model include: evaluation process (keterlaksanaan model), evaluation of the results after implementation model through *posttest*, and observations learning by teachers as a reflection of the implementation, the chosen one of the ECD to implement a model.
- b. Results of implementation model curriculum with a marine developed, the steps to analyzed activities as follows:
  - 1) Analysing the data before the imposition of implementation workshop/model *pretest* and after implementation workshop/implementation model *posttest* (data test after workshop) in the current *treatment*, associated with whether or not there is no change teachers in applying the curriculum ability marine-based.
  - 2) Analysing the data *pretest* and *posttest* to the teacher controls to find out whether or not there is no difference between result *pretest* with the result *posttest* to the ability to teachers in the current controls
  - 3) Analysing the data difference *pretest* and *posttest* groups *treatment* with difference *pretest* controls.
  - 4) Analysing the data differences between groups influence *treatment* with the influence controls based on tests the significance. to know the difference between *gain between groups treatment* with controls.
  - 5) To know whether it is a model curriculum that developed is effective to increase capacity teachers, then take data analysis as mentioned above.

From the analysis of data groups *treatment*, and groups control will be known effectiveness model and its influence to increase the capacity and capability teachers in ECD Education. From the analysis of this "end" model designed *model* based curriculum marine model that has been tested in the implementation phase II). "End" model that has been tested, as "a model that is recommended". The steps were the grand design based curriculum marine can be seen in figure below:

This Research methods, the survey, evaluative feedbacks and experiments. The survey used in or introduction to know a supporter and practices related to the product that will be developed. An Experiment refers to design an experiment *quasi* through *non-equivalent group pretest-posttest design* where *pretest* and *posttest* came into force in both groups treatment (*treatment*), and in the current controls. According to Creswell (2008: 313) that in the design an experiment, there are an experiment and controls. The experiments and controls both of these groups are chosen without stipulation random.

Design an experiment that used in this research can be seen in the picture below:

Table 2 Design an experiment Quasi

Kelompok Experiment	T 1	X	T 2
Controls	T 1	-	T2 processor

Source: Educational Research (Creswell : 314)

Note: T 1 Initial test = (*pretest*)



T2      processor      = Test End (*posttest*)  
X                              = Treatment (*Treatment*)

Both groups given *pretest* and *posttest*, and only the experiment that given preferential treatment (*treatment*). Quasi-Design experiments carried out in the final tests on from the model curriculum that developed. Tests on model based curriculum marine imposed only in the current treatment that has been determined, and the gathering data and analysis test result field is designed with quantitative analysis techniques to see the influence of implementation model, while to validate and to complete model that has been developed is based on data collection, analysis techniques used qualitative research.

### **Location and subject Research.**

Industry research activities carried out in ECD Gorontalo Province, was made as a supporting completeness in to explore various sources of information that closely connected with subjects or, namely teachers ECD.

Subjects or determined by *propulsive sampling* as many as 40 teachers ECD, where 20 people Teachers ECD as respondents in a study introduction and 20 people as respondents in the implementation of a model, namely 20 people for the experiment (*treatment*) in the implementation of model, and 20 people for controls.

### **Technical instruments Data Collection, Research and Development.**

In the implementation of the studies this research, introduction and implementation of testing models, technical data collection is: 1) test, 2) an interview, (3) questionnaires, and (4) observation. The test was given before treatment (*pretest*) and after treatment (*posttest*). An interview conducted in a study introduction to the related in connection with the organization ECD program, and the application based curriculum maritime affairs. While questionnaire that was used there are two kinds of, the first to explore data about teachers in applying the curriculum ability based on marine studies introduction, and the second is used to dig teachers' opinion (participants) about the model that developed in the implementation of implementation model (tests on) and observation is used to accommodate observation data to the teachers in applying the curriculum marine-based on early age children, in connection with based curriculum is whether or not use marine in the process playing, children, observation to teachers in applying the curriculum marine-based in implementation of a model.

### **These steps or**

This research is focused on design model marine-based curriculum. According to the goals in this research, that is a model curriculum with a marine tervalidasi to be recommended to the curriculum that can be used in gorontalo province, thus the entire activity or directed at the five main activities, including: (1) study introduction, (2) development models conceptual, (3) test-limited, (4) implementation model, (testing a recognized person within), (5) drawing up a model that is recommended.

### **Processing techniques and Data Analysis**

Stage in the process research and development known as the cycle *research and development* as revealed by Borg & Gall (1996), composed steps: (1) examine results of research related to the product that will be developed, (2) develops products based on the results of research, (3) tests on, and (4) has reduced devisiensi which was found in the final phase trial field.

Referring to the passage from Borg & Gall was then in this research, analysis of data that used were divided into several stages: (1) work writing data, (2) editing, (3) classify data, (4) to reduce, and (5) the or to provide interpretation.

### **Data interpretation.**

To redefine quantitative data great Teacher ability to each component according to average scores, before and after implementation model, analysis and convert the score based on assessment reference standard. The score Suggests a conversion ability is as follows:

**Table 3. A benchmark for conversion level of ability score ECD Teachers**

Value	Order classification	Note:
85% - 100%	It was Very good	Meet the standard maximum ability
70% - 84%	Good	Has filled ability standards
55% - 69%	Just	Meet the standard minimal ability
< 54%	Less	Has not fulfilled ability standards

Source: *guidelines performance evaluation human resources Development Directorate Diklat (Diklat Directorate General for PMPTK, Department of National Education, 2006).*

With this conversion, it can be determined position teachers ability average, and interpreted to meet or not meet the standard kompetensi used, and made a foundation on which to know the effectiveness of the implementation model that has been developed.

## Results and discussion

### Results of Research

1. The weakness that is fundamental to educators ECD is weak understanding on the use skills and potential maritime activities for fun and children's learning at an early age. This is possible due to lack of involvement in every activity educators especially related to increase the human resource. So this problem very important in the effort to raise the quality of education early age children, on the other early age children is very important developed all competency from an early age.
2. The *kesejangan* between a greater understanding and skills that are now with the understanding and skills that should be an ideal owned educators as a person responsible for the curriculum. *Kesejangan* was supposed to get attention all parties, in particular support of the government resources in empowering people in this was a day-to-day to accompany such a curriculum/ education for his son. Human resources is very important and very determined implementation curriculum/ education in children at an early age.
3. That on average the understanding and skills educators, the increase significantly. In addition motivation educators to teach/educate children at an early age to be better.
4. Grand design curriculum with a marine developed shows effective to enhance the understanding and skill should be considered in the implementation of educators grand design.

### Discussion

1. Grand design marine-based curriculum to improve their knowledge and skills educators is as an offer from the concept provincial education office and district/city, as an alternative in developing educators as one of the main component in a curriculum that more qualified, therefore may grand design curriculum can continue to activities next.
2. Grand design that has been developed, as an alternative that can be applied more, and recommended to related parties in empowering educators to make it more optimal.
3. The increase and develop an understanding and skills educators is an important thing needs to be pursued so that they will be able to use of the potential for maritime in learning. A factual this condition requires efforts to develop their ability educators in many respects, especially so that they carry out his duties as a teacher. Implementation of the understanding and skills by educators in school environment cannot be separated from the condition empirical educators who are considered to be less than to be able to do the curriculum use of the potential for marine affairs. If the understanding and skills educators weak will be reflected in applying the curriculum marine-based on his son. Thus to a need for urgent need for putting educators as a teacher who has the capability and knowledge and skills that reliable in giving/educated his son's use of the potential for marine affairs.

### Closing

Grand design Development marine-based curriculum in its implementation, have shown effectiveness for fulfilling the increase understanding and skills educators. This gives the meaning that the development grand design curriculum that has been done to the implications add the glossary is better in theoretical knowledge and skills early age children to educators, as well as a practical for

operational activities that can be applied in implementation of the training for teachers in a more broadly.

In the development grand design based curriculum this marine of theories berkontribusi strengthen education that could increase diversity in the dimensions early child education. Grand design marine-based curriculum in real have been able to increase understanding and skills educators ECD in Gorontalo Province. According to hits an empirical application grand design shows effectiveness for fulfilling the requirements for the curriculum for children at an early age.

In its implementation, the grand design the curriculum developed shows effective in improving understanding and skills educators, so that it can be a alternative in order to help improve the ability to pembejaran/ education in ECD Education. .

The findings on can be made input in the increase understanding and skills educators, and as the raw material inputs to the event ECD in general, and as such skills curriculum/education by educators. And on the other can improve the quality children education curriculum/early age in ECD Education.

Grand design based curriculum marine has shown effective in improving significantly affect the understanding and skills educators. Based on the result, it is hoped that the decision makers in this case Diknas education provinces, cities and districts may be dissemination grand design marine-based curriculum this as an alternative to support its programs curriculum that effective and efficient in connection with the increase understanding and keterampilan educators, in particular and the curriculum/ education in general. In the implementation of grand design to will continuously implementing identification participants educators by considering its characteristics as input prices, identification learning resources both resource persons, as well as material ajarnya to suit study participants, analysis of potential local characteristics, and supporting facilities and infrastructure smooth execution of activity.

## REFERENCE

- Anita Woolfolk, *Educational Psychology* (Boston: Pearson, 2007)
- Creswell, J. W. (2008). *Educational Research, Planning, Conducting, Evaluating Qualitative and Quantitative Reseachers*, New Jersey : Pearson Merrill prentice hall
- Department of National Education, (2006). *Guidelines performance evaluation human resources Dikta. The construction Diklat Directorate-General Directorate for PMPTK*
- Gall, M. D. Gall .J. P. & Borg W. R. (2003) , *Educational Research An Introduction*, 7 th Ed. Boston: Pearson Education, Inc.
- Government Regulation Number 19 of 2005 on National Education Standards*. Jakarta: the Department of National Education
- Republic of Indonesia. (2003). *Law No. 20 of 2003 on the National Education System*. Jakarta:), Setneg
- Republic of Indonesia. (2005). *Government Regulation Number 19 of 2005 on National Education Standards*. Jakarta: the Department of National Education

# Teaching and Learning on Selected Topics in Electromagnetic Theory Course Using Problem-Based Learning Approach in a Class with a Large Number of Students: A Sharing Experience

<sup>1,a</sup>S. R. Kasjoo, <sup>1,b</sup>M. N. Mohd Yasin, <sup>1,c</sup>W. M. Wan Nor Haimi & <sup>1,d</sup>M. R. Zakaria

<sup>1</sup>School of Microelectronic Engineering, Universiti Malaysia Perlis, 02600 Arau, Perlis, Malaysia,

<sup>a</sup>shahirrizal@unimap.edu.my

<sup>b</sup>najibyasin@unimap.edu.my

<sup>c</sup>wanmokhdzani@unimap.edu.my

<sup>d</sup>rosydzakaria@unimap.edu.my

## Abstract.

Currently, the problem-based learning (PBL) approach at higher learning institutions has been widely implemented in many education fields including engineering in order to enhance the students' knowledge, skills and attitude. In this report, the concept of PBL using a module known as 5 Ladders of Active Learning, has been utilized and used (to a certain extent) in the teaching and learning for 218 students on selected topics in Electromagnetic Theory course offered at the School of Microelectronic Engineering, Universiti Malaysia Perlis. Based on the observed results, we strongly believe that, adopting the PBL approach has improved the students' performances especially in terms of knowledge when compared to the conventional approach of teaching and learning.

**Keywords:** *engineering; problem-based learning; teaching and learning.*

## 1 Introduction

Problem-based learning (PBL) is one of the student-centered pedagogy approaches in which the learning curve about any particular subject is developed through the experience in problem solving. The PBL approach was first introduced in the 1960s at the School of Medicine, McMaster University, Canada, and since then, it has been spread all around the world especially when it has been proven to be one of the most successful strategies in helping to improve and enhance the process of learning at tertiary level [1] – [3]. In Malaysia, the inclusion of PBL approach in engineering lectures at institutions of higher learning has been pioneered by a group of people from Universiti Tun Hussein Onn (UTHM), Malaysia back in 2005 to improve the necessary knowledge, skills and attitude of graduated students required by the engineering-based industry [4].

In this report, we present, to a certain extent, the concept of PBL implemented on selected topics in Electromagnetic (EM) Theory course to 218 students of cohort 2013/2014 at School of Microelectronic Engineering (SoME), Universiti Malaysia Perlis (UniMAP), Malaysia. The initial assessment of this approach in term of knowledge was solely determined by the examination results taken by the students at the end of the semester. The details regarding the EM Theory course and the analysis of the PBL approach are to be further elaborated in the next sections.

## 2 EM Theory Course at SoME, UniMAP

The EM Theory course is a compulsory subject attended by second year students at SoME, UniMAP in order to complete their Bachelor of Engineering (B.Eng) degree (with Honours) either in Microelectronic, Electronic or Photonic Engineering. The outcomes of this course are:

- i) Ability to apply, derive and analyze electrostatics and magnetostatics.
- ii) Ability to apply, derive and analyze Maxwell's Equations.
- iii) Ability to apply Maxwell's Equations and interaction of electromagnetism in devices.

In order to attain these outcomes, a minimum of three-hour lecture in a week (for 14 weeks) has been allocated. According to the outlined teaching plan (for guideline), the contents of the lectures that cover the related topics (with sub-topics) are as shown in **Table 1**.

**Table 1.** Course content of Electromagnetic Theory at SoME, UniMAP.

Study Week	Course content
1 – 4	<u>Electrostatics</u> Coulomb's Law, Electric Flux Density, Gauss's Law, Electric Potential, Dielectric Polarization, Dielectric Constant, Boundary Condition, Poisson's Laplace, Resistance and Capacitance.
5 – 8	<u>Magnetostatics</u> Biot-Savart's Law, Ampere's Law, Magnetic Flux Density, Magnetic Force, Torque and Moment, Magnetic Dipole, Inductor and Inductance.
9 – 10	<u>Electromagnetics</u> Faraday's Law, Displacement Current, Maxwell's Equations, Potential and Fields.
11 – 14	<u>Wave and Energy</u> Waves, Plane Waves, Power, Poynting Vector, Reflection, Impedance SWR, Transmission Lines, Smith Chart, Introduction to Waveguides.

### 3 Problem-Based Learning Approach

The PBL module used in the teaching and learning of EM Theory course is known as 5 Ladders of Active Learning [5]. In general, Ladder 1 is the introduction of any selected topic to the participants who are required to identify the learning issues from a given problem scenario. Ladder 2 involves self-directed learning activities including research through readings, watching videos and so on. The information obtained from the self-directed learning activities is then reported at Ladder 3 in group meetings and discussions. During Ladder 4, the participants are required to present and share their findings which have been discussed and prepared at Ladder 3. The last ladder (Ladder 5) focuses more on the additional exercises related to the topics as well as the overall reflection on the learning activities that the students have gone through from Ladder 1 – 5.

The number of students who have attended the EM Theory course at SoME, UniMAP was 218 people for cohort 2013/2014, as previously mentioned. The PBL approach (to a certain extent) was conducted to these students on some selected sub-topics which include Ampere's Law, Faraday's Law, Maxwell's Equations and Plane Waves. Since the number of students was quite large, these students were divided into several groups, each of which consisted of 10 members (maximum) and must appoint their own group leader.

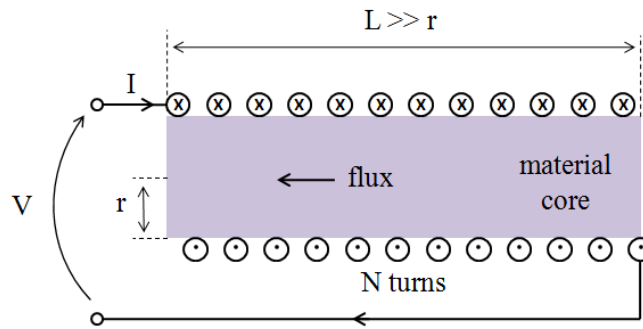
At the beginning, a conventional lecture (i.e. the standard teacher-centered learning approach) on the selected topics was delivered briefly to introduce the topics. Each group was then assigned with a so-called 'trigger' (problem) which has to be discussed among the group's members and to determine the solution within a two-week period. The trigger is one of the important components in PBL which has to be carefully designed in order to initiate the lesson and learning process of any targeted topic. Some of the triggers used in this work were:

- **Trigger 1:**

*Figure 1 shows a long finite solenoid with some parameters. Using equations related to **Faraday's Law of induction** and **Ampere's Law**, prove that the **power per unit volume** flowing into the solenoid is equal to:*

$$\mu H \frac{dH}{dt}$$

*where  $\mu$  is the permeability of the material core and  $H$  is the magnetic field.*



**Figure 1** A long finite solenoid

- **Trigger 2:**

Using **Maxwell's Equation I** in a **loss-less dielectric**, show that the vector of electric field,  $\mathbf{E}$ , is **transverse** ( $\mathbf{E}$  is perpendicular to **wavevector,  $\mathbf{k}$** ). In other words, prove that the z-component of  $\mathbf{E}_0$  is equal to zero [i.e.  $\mathbf{E}_0 = (E_{0x}, E_{0y}, 0)$ ] where  $\mathbf{E}_0$  is the vector of the amplitude of  $\mathbf{E}$ .

- **Trigger 3:**

Given that  $\mathbf{E}_0 = (E_{0x}, E_{0y}, 0)$  where  $\mathbf{E}_0$  is the vector of the amplitude of electric field vector,  $\mathbf{E}$ . By using **Maxwell's Equation III** in a **loss-less dielectric**, show that:

$$\mathbf{H}_0 = \frac{k}{\mu\omega} (-E_{0y}, E_{0x}, 0)$$

where  $\mathbf{H}_0$  is the vector of the amplitude of magnetic field vector,  $\mathbf{H}$ , and  $\mu$  is the permeability.

As can be seen from the trigger examples, the words in bolds were the key initiators to find the appropriate solutions of the given problems. The students therefore have to perform their own study by any means necessary including readings and watching videos in order to understand these words at the beginning of their learning process. The leader of each group has the responsibility to organize any discussion or group meeting outside the lecture hours to complete the assignments given. Activities that can develop the students' soft-skills such as delegation of tasks, working in groups and effective communication would be automatically taken place in the process of learning through this PBL approach. In order to encourage participation from all members in each group, a peer-to-peer assessment (see **Appendix A**) within the group itself has been introduced. The students therefore have to deliver their utmost contributions to obtain high mark from the peers. After two weeks, each group has to share and present its findings in front of all other groups and there would be a group-to-group assessment (see **Appendix B**) during the presentation.

## 4 Findings and Discussion

Adopting PBL approach has helped the students to actively learn about the selected topics not only by themselves through their own research, but also from the discussions and exchanging ideas among the group's members. The students have enhanced their study skills especially on how to conduct library research and extract useful information in order to solve any given task. The presentation has encouraged the students to deeply understand the topics they have been assigned because during the presentation session, they have to effectively and articulately convey what they have been learning within the two-week period. Hence, through PBL approach, the students not only became more proactive, creative and innovative, but also improved their soft skills including

teamwork, communication, management and leadership which are very essential for a competent engineer. This has significantly helped to attain the outlined outcomes of the EM Theory course as mentioned earlier.

To partially assess the success of the PBL approach adopted in the EM Theory course at SoME, UniMAP, a final examination paper of this course, which consisted of five questions, has been designed accordingly. Questions 3 and 4 were set based on the topics whereby the students have experienced an active learning process via PBL approach. Each question carried 20 marks and the duration of the final examination was three hours. **Table 2** shows the results obtained by the students of cohort 2013/2014 at SoME, UniMAP, based on the questions (question 1 – 5) set in the final examination of EM Theory course. As can be seen, question 3 (Q3) has the highest average mark of 14.83 with standard deviation of 4.13, followed by question 4 (Q4) with average mark and standard deviation of 12.82 and 4.48, respectively. This could be used to reflect the success of the PBL approach adopted in the teaching and learning process for topics that were covered in Q3 and Q4 when compared to the results of the other questions. Nevertheless, there are also many other factors that contribute to the results obtained in **Table 2**, which are not discussed in this report.

**Table 2.** Final Examination Results of Electromagnetic Theory at SoME, UniMAP.

<b>Final Examination of Electromagnetic Theory Course</b>					
	Q1	Q2	Q3	Q4	Q5
Highest Mark	20	20	20	20	16.5
Lowest Mark	0	0	2	2	3
Average Mark	5.81	7.11	14.83	12.82	10.98
Standard Deviation	4.19	4.61	4.13	4.48	2.97

## 5 Conclusion

In summary, based on the results and discussion presented in this report, the PBL approach implemented on specific topics in the EM Theory course for 218 students (cohort 2013/2014) at SoME, UniMAP has significantly helped the students not only in attaining the outlined course outcomes but also in developing and nurturing many soft skills which are necessary for the students once they have completed their undergraduate study and started to work in the industry. The inclusion of PBL approach in teaching and learning for engineering courses at tertiary level of education is therefore very essential and recommended.

## 6 References

- [1] Barrows, H. S. (1996), Problem-Based Learning in Medicine and Beyond: A Brief Overview, *New Directions for Teaching and Learning*, 1996(68), 3-12.
- [2] Hmelo-Silver, C. E. (2004), Problem-Based Learning: What and How Do Students Learn, *Educational Psychology Review*, 16(3), 235-266.
- [3] Schmidt, H. G., Rotgans, J. I. & Yew, E. HJ. (2011), The Process of Problem-Based Learning: What Works and Why, *Medical Education*, 45(8), 792-806.
- [4] Mohd Salleh, B., Othman, H., Esa, A., Sulaiman, A. & Othman, H. (2007), Adopting Problem-Based Learning in the Teaching of Engineering Undergraduates: A Malaysian Experience, *International Conference on Engineering Education (ICEE) 2007, Coimbra, Portugal*, 1 – 5.
- [5] Othman, H. et al. (2013), Training of Facilitators in Problem-Based Learning: A Malaysian Experience, *Proceedings in the 4th International Research Symposium on Problem-Based Learning (IRSPBL) 2013, Kuala Lumpur, Malaysia*, 305 – 316.

## Acknowledgement

The authors would like to thank to Assoc. Prof. Dr. Hussain Othman, Assoc. Prof. Dr. Berhannuddin M. Salleh and Akademi Kepimpinan Pengajian Tinggi (AKEPT) for their assistance, guidance and the use of the facilities for workshop sessions.

**Appendix A**

**EMT238 ELECTROMAGNETIC THEORY  
GROUP ASSIGNMENT  
PEER-TO-PEER ASSESSMENT**

NAME: \_\_\_\_\_

MATRIX NO.: \_\_\_\_\_

PROGRAMME: RK05 / RK86 / RK89

GROUP NO.: \_\_\_\_\_

**Guideline:**

- This is a peer-to-peer assessment.
- Mark is given based on the contribution of each member of the group to complete the assignment.
- Mark is given in the range from 1 – 5.  
1: very low      2: low      3: average      4: good      5: excellent

No.	Name	Matrix No.	Programme (RK05/RK86/RK89)	Mark
1.				
2.				
3.				
4.				
5.				
6.				
7.				
8.				
9.				
10.				



**Appendix B**

**EMT238 ELECTROMAGNETIC THEORY  
GROUP ASSIGNMENT  
GROUP-TO-GROUP ASSESSMENT**

GROUP LEADER'S NAME: \_\_\_\_\_

MATRIX NO.: \_\_\_\_\_

PROGRAMME: RK05 / RK86 / RK89

**Guideline:**

- This is a group-to-group assessment.
- Mark is given in the range from 1 – 4. Mark is given based on:
  - i) Delivery
    - 1: not smooth    3: articulate and organized
    - 2: quite articulate                                      4: smooth and very articulate
  - ii) Content
    - 1: poor and very difficult to understand      3: very good
    - 2: moderate    4: outstanding and easy to understand

No.	Group No. (group leader's name)	(A) Mark on Delivery	(B) Mark on Content	Total Marks (A + B)
1.				
2.				
3.				
4.				
5.				
6.				
7.				
8.				
9.				
10.				
11.				
12.				
13.				
14.				
15.				
16.				
17.				
18.				
19.				
20.				

## **DIALOGICAL LEARNING STRATEGIES TO FORM CHARACTER IN THE ALTERNATIVE SCHOOL “QARYAH THAYYIBAH” IN KALIBENING VILLAGE, SALATIGA, CENTRAL JAVA**

By: Fakhruddin \*<sup>1</sup>

### **ABSTRACT**

The study used a qualitative approach with the aim of exposing the dialogical learning management instill character values in the students. Sources of information obtained from the teacher/chaperone and manager of the Alternative School “Qoryah Thayyibah” in Salatiga with through interviews, observation and questionnaires and then analyzed thematically. The results showed that: (1) planning is done together with students, while the teacher/chaperone role as facilitators in achieving competence, (2) implementation of dialogical learning in instilling the values of religiosity, self-reliance, honesty, respect, responsibility, discipline and collaboration in learning is done through (a) the degree of integration work, (b) the casting idea or notion of learners in discussion and group work. Meanwhile, to build tolerance, social care carried out by involving learners in a variety of social activities, e.g. a party celebration or died neighbor directly involved without seeing strata, social status and confidence. Then to reward achievement, hard work, creativity and independence of learners performed either by writing the work, document and even published works in collaboration with the publisher. Based on the recommended plan and implement problem-based learning, the determination of the focus remains the primary concern should be the teacher/chaperone so the learning quality is maintained and the rights of parents as the first and foremost educators are not neglected.

### **INTRODUCTION**

Learning in a learning group is essentially a process of dialogue on various issues that are packed in the topic with the goal of learning experiences on achievement of competencies. The role of this dialogical reinforces the position/role of teachers and learners are not in a position above the bottom but equal or equivalent in a process of mutual learning. There is no mutual dominance between the two sides, but mutually complementary. Teachers consider the matter again when learners express their perspective on the matter. The expected result of Problem Posing Method learners are not expected to simply accept its existence, but dare to critically question the existence, even change it. Problem Posing Method is considered successful when the students do not become an information memorizer, but when he knew with the critical information they have, what the connection was with her information, and how to use them to make a change, so the learning does not have to be limited to the reading of "word", reading "text", but always believed that education should also include the practice of "reading context" and "reading the world" (Freire, 2005:50). Equality in the Alternative Education School “Qaryah Thayyibah” inspired by exploiting nature, life, and the

---

<sup>1</sup> Fakhruddin, Lecture of Out school Education in Educational Science Faculty of Semarang State University

environment as a learning medium. The alternative school “Qaryah Thayibah” is an example of liberation and empowerment education that aims to create quality human resources, so it is not be separated from science received and studied by learners in school. Equality in education programs of the Alternative School “Qaryah Thayibah” introduces a method of education by dialogical method, which was built dialectical dynamics between educators and students in the face of the reality of the world.

Based on this, the problem studied are (1) what are the values which are transmitted through the design of learning on the learner is religiosity, self-reliance, honesty, respect, responsibility, discipline and cooperation in learning, (2) How do models of learning areas related to achievement, time management, tasks in learning activities and (3) How dialogical learning strategies that teachers do the following companion obstacles in the process of internalization of the values instilled. Character education includes the education equality not just teach what is right and what is wrong, it's more of a character education inculcate the habit (habituation) about good things so that learners into schools (cognitive aspect) of what is good and wrong, able to feel (affective aspect) good value and want to do it (psychomotor aspects), thus instilling character was closely related to the "habit" or continuous habit practiced and performed. Thus the essence of character education is the cultivation of the good capacity, both in the context of the individual as an individual and as a member of society. So how is the focus? In this case Berkowitz (2005) explains that the capacity of a single dimensionless goodness, but rather involves the ability to think about right and wrong, moral engagement, moral goodness and showed a consistent tendency to act honestly, altruistic, responsible as well as other properties of the support function moral.

In the praxis of education, the value of the good application in the form of action or behavior attached to labeling such a person behaves lying, hypocritical, cruel or even greedy in many ways be regarded as ugly-characterized people, while the people who behave in an honest, concerned with others, like helping and just said to be of noble character. So the term is closely related to the personality of the character (personality) a person, where a person can be called a person of character (a person of character) if their behavior in accordance with the applicable rules and moral philosophy espoused. In formal education, especially related to experiential learning (curriculum) Berkowitz (2005: 47) states that, in practice, the integration of the charge character into the curriculum in general can be reached in two ways, namely by adding the charge of learning and provide a special session outside the formal learning to develop character specific. Accentuation which of the two types of these, which definitely requires a deal both the need to ensure that the character has become one of the focus in learning. Therefore, it must be ensured content appeared in the planning and implementation as well as the measurable outcome even in the form of textual

description. In this study Winge (2006: 105) set out the criteria that the successful learning of character is not when someone performs actions that are socially or morally acceptable. In other words, character education in elementary education settings should be able to grow a permanent morale boost in self-learners. More important than that all is of course true understanding of what is meant by character. Without a true understanding of character education is not only the potential to be one way, but the perpetrators did not get the certainty of the meaning of what they are doing. In *The Science of Character Education*, Berkowitz (2005: 47) advised, "it is a futile for us to make a good mouse trap without us ever know what such a rat". It presupposes on the one hand exploration of character that develops understanding among actors character education. On the other hand, systematic efforts are needed to ensure that they have the correct understanding. Character education as developed by the Ministry of Education and Culture, which includes the main 18 (1) religiosity, (2) fair, (3) tolerance, (4) discipline, (5) hard work, (6) creativity, (7) independent, (8 ) democratic, (9) curiosity, (10) the spirit of nationality, (11) patriotism, (12) the achievements, (13) friends / communicative, (14) love peace, (15) likes to read, (16 ) care about the environment, (17) social care, (18) a sense of responsibility.

Education learning activities in schools especially have a very large role in shaping the personality or character of the students, although the study of students can learn with or without a teacher, he is still learning, so that learners become managers for himself in the study, because the nature of learning indeed is how learners perform activities in changing himself, from not knowing to knowing, from unskilled become skilled, and so on. If the concept of learning is actually implemented, the task of a teacher is not to be lighter, but it becomes more severe. Teachers must be able to perform various activities in choosing the design and learning strategies that learners' learning process continues with or without his presence. To assure the occurrence of this, teachers must be able to prepare a learning atmosphere conducive, which gives the possibility for learners to enjoy learning without being limited in the classroom and outside the classroom. For this purpose, professional teachers are required to master a variety of approaches to managing learning.

Based on these assumptions, it is important to conduct a study conceptually (red line) on the theory of teaching and learning. Learning theory is basically the concepts and principles of learning that is both theoretical and experimentally verified. As a descriptive science, learning theory serves to explain what, why and how learning occurs in the process of learning and this is what gave rise to the learning theory such as behaviorism, cognitivism, humanism, and so on. Learning-oriented learners how to behave, giving meaning that learning is a collection of individual processes, which change the stimuli from the environment into a number of information a person, which in turn can lead to changes as a

result of learning. Slavin (2006: 98) states that learning is usually defined as a change in an individual caused by experience. This opinion confirms that learning is essentially a change in the individual acquired through experience. Galton (2007: 35) confirms the important thing is how the cognitive processes children use to process the information that has been obtained. Based on these opinions, learned contains elements that; (1) a change in behavior at the individual, (2) changes occur because of experience or information obtained.

From exposure to the many theories that examines the most important lesson for educators is how to understand the theory, how it works, where and how to focus on learning by modifying the design and accommodates most suitable to the characteristics of learners, the purpose of the material, classroom situations and learning path implemented, because in practice there is no theory of the most superior, but the eclectic will complement and enhance. In line with this, the process of character education in an alternative school is expected to produce learners who have extensive knowledge, high commitment to cultural values and have good manners in everyday life. Thus the goal of character education not only in the aspect of knowledge or knowledge alone, but rather the behavior and characteristics as defined by the Ministry of Education (2010) which covers religiosity, honesty, tolerance, discipline, hard work, creative, independent, democratic, curiosity, a sense of pride, patriotism, recognize excellence, friendly, peace-loving, fond of reading, environmental care, social care, and responsibility. Learning as proposed by Paulo Freire dialogue should be done or known as the Problem Posing Method or method of filing a problem with the aim to raise awareness of reality. Dialogic learning involves the learners/learners in all important activities that help in linking between academic learning with real-life context that they face. By linking the two, meaning the students involved in the school work. The purpose of dialogue is a learning process so that students raise awareness of reality. Dialogic learning as an approach emphasizes the process of full engagement of learners to be able to find the materials studied and relate it to real life situations that encourage learners to be able to apply it in their lives (Sanjaya, 2005:109).

From these concepts, there are three things that need to be understood (1) Dialogic learning emphasizes the process of civic engagement learning to find the material, meaning that the learning process is oriented to the process of direct experience. The learning process in the context of dialogue not just expect people to learn a lesson, but the process of searching for and finding himself the subject matter, (2) learning Dialogic encourages residents to learn in order to find the relationship between the material being studied with real life situations. This means that the learners are required to be able to capture the relationship between learning experiences in school to real life. It's no longer just memorization of information, yet functionally meaningful, (3) learning Dialogic encourages

residents learn to apply in life, meaning that students not only understand the material, but how the learning materials that can color their behavior in everyday life. Based on the study, thought and study of dialogic learning strategies ranging from planning and implementation in instilling character of the learners will be very important. Learners with different characteristics are how to develop the potential in the form of actual behavior itself (learning to be) and in the context of living in harmony with the environment (learning to life together).

## METHOD

This study used a qualitative descriptive approach, with a focus on the planning and implementation of dialogic learning or problem posing method known. Conducted research is conducted at the Alternative School “Qaryah Thayyibah” Kalibening village of Salatiga. To obtain information used observation, interview and documentation. In order to evidence the findings of the information or the validity of the results of the examination field with triangulation and further through the reduction and presentation will be concluded.

## RESULTS AND DISCUSSION

### 1. Lesson Planning

Planning learning in the alternative school “Qoryah Toyiybah” not textually must be poured by Syllabus and RPP (Lesson Plan) as a national curriculum, but the meaning of the syllabus content associated with the competency to be achieved remains a major concern. In terms of providing opportunities for learners in the learning plan turns out there is a difference; lesson plans for grade 1 was 50 percent helped by the teacher/chaperone. It is to change the child mindset of teaching and learning be learning together. While the grade 2 has little independent due to previous experiences in the classroom. The grade 3 is completely independent of what they want to learn.

Based on the conclusions obtained in the Alternative School “Qaryah Thayyibah” national curriculum is only used as a reference or references in the learning activity, with variations on the high grade left entirely to the students, while the teacher's role in low grade/learning companion in planning between 25-50 percent. With these models, expected every child to have the freedom to determine the content of the material or what topics will be studied. Strategies for planning lessons jointly conducted with the involvement of the students indicated that the planting character of students who are creative, independent and responsible is a major concern. In addition, through the planning is done jointly or group will be able to create characters care about others and cooperation.

### 2. Implementation of Dialogic Learning

Implementation of the Alternative Learning School “Qaryah Thayyibah” formally demonstrated no uniform, order and schedule subjects remain, but there is only scheduled study time. The observation that has been done, the teacher/chaperone English is taking an important role in designing English language materials are given in English Morning sessions are always a learning activity every day opener. Before starting the study, they have to get used to pray in the English language. Despite of the village children, they are trained to be able to hear, read, write and communicate in English. Furthermore, in the phase II study were studied material tailored to the lesson plan that had been developed by the child on the first day of each week. While phase III and IV occur incidentally children grouped according to their respective interests.

The result of Interview with the school manager in applying the analysis of dialogic learning is that the learners have a religious character, creative, independent, social care and have the confidence and respect of achievement is to hold a large memorial day with the title of the work of integrating learners. Then to instill honesty handed to students how the idea or ideas without having to make a canteen or suggestion box. E.g. there is a missing item simply taped announcement. In the growing level of creativity in learners, obtained from observations on biological materials with project learning, when it took place in the area of rice fields owned by anyone even wallow in the trash to look for second-hand goods study of organic and inorganic waste material to be something helpful.

Based on interviews and observations, it can be affirmed that the place they learned based on the agreement between children and companion. If they are not happy to learn face-to-face in the classroom, these activities can be moved to the open air outside the classroom. When children and companion agreed that certain materials should not be done in the classroom, they will not learn in class, but they will learn outside the classroom, both individually and collectively based on the competencies that must be controlled according to the material. This is the principle of learning in “Qaryah Thayyibah” is that basically can be done anywhere and anytime as long as people want to keep learning. If learning glued to the room and other facilities that then when all the facilities are not already, so learning activities will be hampered.

Findings related to the planning and implementation of learning, it can be argued that the learning plan drawn up by the teacher at the Alternative School “Qoryah Toyiybah” based on the real needs of learners who puts children really as the main actor sustainability learning activities. Lesson plans arranged weekly based on the national curriculum which is only used as a reference or referral by insisting that every child has the freedom to determine the content or subject matter to be studied. Everything uphold the principles that intrinsically children as

subjects students are free actors have unique interests, background, potential, talents, different abilities that must be developed in accordance with the needs and preferred by children. This is in line as stated Bahruddin (2008:56-59) that the learning will be effective if the learning materials are selected based on the needs of the students (Student Learning Center) has three benefits: (1) learning materials based on the needs of the students will make learning more meaningful, (2) learning materials based on the needs and be motivating to learners pleasure in following the learning process, (3) learning based on the needs of the students had educational benefits that the impact termed accompaniment (nurturing effect) give an example to they live humanist. They are given an example of an attitude to respect the wishes of others, do not impose the will when faced with the desire of many people. The same thing also expressed Salirawati (2012: 217) describes the character education in schools is also strongly related to the management or the management of the school is how character education is planned, implemented and controlled in educational activities in the form of curriculum, teaching, assessment, teachers and , and other related components.

Learning plan as presented Freire (2005: 42-43) which gives freedom to the students to know and to design their own learning systems, look for yourself what will be learned, ask questions and even question the reality of the self and the surrounding environment. Teachers in this activity only serve as a companion as well dynamist learning. In the context of local-based education, is used with the locality rule. This rule is intended that the integrated components son, companion, managers, administrators, parents, and community work together and participatory friendship forged in the system. For those who have adequate educational background serve as the school committee. For children in the Alternative School "Qaryah Thayyibah" is a place to play with the community, the village as a laboratory for learning, as a provider of wide knowledge without depending on the availability of facilities. The presence or absence of instructional media does not become a barrier to the child's learning. Schools have a tightly closely with the community and with the natural optimally utilized with all the potential that exists as a medium of learning.

Implementation of the Alternative Learning School "Qaryah Thayyibah" used problem-solving method with the hope to master the competencies that must be mastered. This is different in our schools tend to use a more conventional approach in which the teacher-centered learning, more one-way communication from the teacher to the learner, the learning method uses more lectures, learning materials and more on mastery of concepts instead of competence. Freire (2005: 3) which states that .....choose the best response, test them-selves, act, and change in the very act of responding. Therefore, students will only be able to know when faced with real problems, so that the learning process is always embedded in an understanding not rote-memorization and knowing not the same as knowledge



swallow raw. The problem-solving method in a dialogical education is used to displace the storytelling methods (lectures) are commonly used in the banking system of education. Fill narrated lessons both about values and empirical aspects of reality in the story even become stiff and do not tend to live.

Some forms of dialogical learning is used through integration work degree will give the possibility to the students to be independent, creative, self-confidence and sense of responsibility. In addition, through the independence of learners to manage their own and in groups will give students the possibility of cooperation, caring with friends and even discipline in accordance with the commitments agreed with the group. In terms of integration with the local environment is a community of learners as a learning laboratory.

## CONCLUSIONS AND RECOMMENDATIONS

Based on the above description, it can be concluded (1) Planning dialogical learning in the Alternative School “Qaryah Thayyibah” is designed based on the needs and agreement between learners and teachers. The draft national curriculum learning still refers to the procedure of each learner make a proposal for the topic material to be studied, then summarized and agreed the material topics that will be studied for determining priority learning needs, (2) learning approach used in instilling character in the students with the problem-solving methods based on thematic or theme based on the needs of each subject studied. Through brainstorming learners are given the widest opportunity to pose a problem or question in accordance with the agreed material (problematic).

Based on these results, it needs to be recommended, among others; (1) In the problem-based learning plan, the determination of the focus remains the primary concern should be the teacher/chaperone so the learning quality is maintained, (2) implementation of learning as one of the practical implementation exemption on learners, especially with the enactment of hours of learning that is not limited, it is feared would deprive the family as the first and primary education.

## REFERENCES

- Baharudin, Ahmad. 2007. *Pendidikan Alternatif Qaryah Thayyibah*. Yogyakarta: LKIS Yogyakarta.
- Berkowitz, M. W., & Bier, M. (2005). *What Works In Character Education: A research-driven guide for educators*. Washington: Character Education Partnership.
- Freire, Paulo. 2005. *Education For Critical Conciousness*. London. New York: Continuum.
- Galton, J, Maurice. 2007. *Learning and Teaching In The Primary Classroom, Los Angeles*. London, New Delhi, Singapore: Sage Publications.
- Kementerian Pendidikan Nasional. (2010). Rencana Strategis Kementerian Pendidikan Nasional Tahun 2010-2014.
- Mulyasa, E. 2007. *Standar Kompetensi dan Sertifikasi Guru*, Bandung : Penerbit PT Remaja Rosdakarya.
- Salirawati, Das. 2012. *Percaya Diri, Keingintahuan, dan Berjiwa Wirausaha: Tiga Karakter Penting Bagi Peserta Didik*, Jurnal Pendidikan Karakter, Tahun II, Edisi 2 Tahun 2012.
- Sanjaya, Wina, *Pembelajaran dalam implementasi Kurikulum Berbasis kompetensi*, Jakarta, Penerbit Kencana Prenada Media Group.
- Slavin, Robert E. 2006. *Educational Psychology, Theory into Practice*. New Jersey: Prentice Hall, Englewood Cliffs.
- Wringe, C. 2006. *Moral Education: Beyond the Teaching of Right and Wrong*. Netherlands: Springer.

## AFFECTING FACTORS ENHANCING DRUG ABUSE IN INDONESIA

Harri Santoso and T Hafliyah

Fakultas Ilmu Kesehatan Universitas U'budiyah Indonesia  
Fakultas Hukum Universitas Syiah Kuala

[harri@uui.ac.id](mailto:harri@uui.ac.id)

### ABSTRACT

This study discusses the affecting factors enhancing drug abuse in Indonesia. Drug abuse isn't only reach out adults but also children. It then attempts to explain what affecting factors enhancing drug abuse in Indonesia in two aspects culture, law enforcement and health. Besides it then attempts to propose a holistics strategy to decrease drug abuse in Indonesia. Indonesia has a largest population in the world is potential market for cigarette and drug company. Based on data Badan anti Narkoba Nasional in 2011 the number of drug users in Indonesia has around 3.81 million, and this number will continue increase if the mass of awareness is not immediately performed. To decrease drug abuse in Indonesia government and the entire community must come together and make a complete and comprehensive effort that includes the fields of culture, law enforcement and health.

**Keywords: drug abuse, culture, law enforcement and health.**

### INTRODUCTION

NAPZA (Narcotics, Psychotropic and Other Addictive Substances) is the material/substance/drug if it gets into the human body affects the body, especially the brain/central nervous system, causing health problems physical, psychological and social function due to habits, addiction (addiction), and drug dependency to NAPZA. (BNP, Jabar, 2010). The problem of drug abuse in Indonesia is a very complex issue that requires a comprehensive prevention efforts and to involve many elements, both in the civilian and military government and civil society in general on an ongoing basis. Based on the survey results of Badan Anti Narkotika Nasional (BNN) and Pusat Kesehatan Universitas Indonesia (UI) estimate the prevalence of drug abuse in 2009

was 1.99% of the Indonesian population aged 10 - 59 years. In 2010, the prevalence of drug abuse increased to 2:21%. Furthermore, the survey estimates of drug abuse cases in 2009 amounted to 3.3 million people and will continue to increase to 4.5 million people in the year 2013, (BNN, 2008).

This paper will discuss the factors that cause high rates of drug abuse in Indonesia in terms of culture, law enforcement and health. While providing a comprehensive solution to drug abuse prevention in Indonesia. 2<sup>nd</sup> IMT- GT Regional Convention on Drug, Substance & Alcohol Abuse among Tertiary Institutions 2014 (IMTGT2014)

### **SMOKING AS HABITUAL**

In a study by the National Center on Addiction and Substance Abuse (CASA) in the United States, it is known that 1 of 4 addicts begin to try drugs since know cigarettes. Therefore, the experts at CASA agreed that teens who smoke are more vulnerable to various types of drug abuse. Thus, to prevent the spread of drug use government should also give more attention to the issue of tobacco use. (CASA, 2007). Economic Survey of the National Statistics Agency (Badan Pusat Statistik) (BPS, 2004) showed an increase in the number of smokers who started smoking at the age under 19 years, from 69% in 2001 to 78% in 2004. This survey also shows a trend of age of initiation of smoking became increasingly early, ie 5- 9 years of age. Smokers who started smoking at the age of 5 - 9 years experienced the most significant increase, from 0.4% in 2001 to 1.8% in 2004. This is in line with the KPAI's monitoring result, Currently, smoking habits in children tends to increase and begins at younger ages, for example They start smoke at the end of school age or teenagers. (KPAI, 2013). Andalas University Research center has done a research with respondents in the West in 2004 showed that 97.7% of children start smoking at the age

under 16 years. Another research in the Special Region of Yogyakarta in 2004 showed the following data: teens start smoking age 7- 12 years were 20.84% for men and 4, 17% for women. Age 13 - 15 years - old male were 12.50% and for women as much as 8.33%. Age 16 - 18 years - old men as much as 47.92% and for girls as much as 6.25%. (KPAI, 2013). Further research Surindo Youth Pulse III (Alamsyah, 2010) states that 17.4% of respondents who had tried drugs turned out to 45.1% have ever tried smoking. Early adolescent conduct drug abuse starts from smoking, by reason of lowering the tension, the development of an unconscious habit, association with socializing and fun capabilities and the physical addiction to nicotine. (Wibowo, 2010). All health experts including the World Health Organization (WHO) has long concluded, that the health, cigarettes cause many negative effects, especially for children and their future. In addition, an individual who has smoking habit will be able to stop in the next 20 - 25 years.

## **LAW ENFORCEMENT**

Although drug abuse and corruption have been included as extraordinary crime in Indonesia, many cases of drug abuse is not sentences maximally. As an illustration of the case in one of the drug factory owner in West Java which is capable of producing up to 6000 grains of heroin. This drug factory owner ever sentence 12 years in prison for the same case but he was freed in 7 years (BNN, 2013). Furthermore, release from prison to the Australian who has caught by drug abuse case. She brought heroin weighing 4.1 Kg and had been sentenced to 20 years in prison, but later received a reduced sentence and release from prison in February 2014, (BBC, 2014). From 2 of the legal treatment in drug abuse cases above, we can have the conclusion that the penalties were not able to provide a deterrent to the offender and the weak implementation of the law and therefore can't give a positive effect on reducing drug abuse in Indonesia.

## **HEALTH LEGISLATION**

An increasing number of drug abuse cases in Indonesia are not only caused by smoking habits among the people of both adolescents and adults, but also the rules that exist in Indonesia. Act No. 36 Article 113 paragraph 2 of 2009 on Health, which reads as paragraph 1 of addictive substances including tobacco, tobacco-containing products, solids, liquids and gases that are addictive which its use may cause harm to themselves or the community. Although this law has been mentioned as one of the tobacco and the addictive substance requires central and local government to provide smoke -free areas, but this law didn't give sanction to the Local Government that can't implement the law. So the existence of Health legislation is still not able to give a definite emphasis on the prohibition of cigarettes as one of the entrances into the drug community.

## **COMPREHENSIVE STRATEGY**

Needed comprehensive strategy and supported by the whole society, it is because Indonesia isn't only a potential market for the drug marketing but also a factory which has been producing these objects. So that a comprehensive effort must be provided to get optimal results.

At least there are some strategies and recommendations from the Departemen Kesehatan at the Workshop on Tobacco Control Policy(KPAI, 2013). At first, ratify the Convention on Tobacco Control (FCTC). Of course it isn't easy because the tobacco industry controlled by the power of money will definitely make opposition. In FCTC clearly regulated levels of nicotine in cigarettes and ordinances advertise more civilized, so we can't find tobacco advertising in public places and times effective in the entire territory of the Republic of Indonesia. Secondly, the country altogether Exempt from cigarette advertising in public spaces anywhere. In Singapore, Malaysia, Thailand, Japan, America and Europe we can't find a billboard advertising cigarettes, also on television.Thirdly, It should be in introduction child protection laws of the

dangers of smoking. At least, insert the provisions of the dangers of smoking for children in the revised Health Act are being prepared. This law should include provisions; children's smoking ban, ban trade in cigarettes to children; ban on cigarette factory employing children, pregnant women smoking ban, and the ban on smoking in front of pregnant women. Fourth, that stuff isn't easy to obtain cigarettes, the cigarette tax should be raised as high, but the production of cigarettes should be suppressed as low as possible. Fifth, make provisions prohibiting cigarette manufacturers to sponsor sport events, art, and science activities. Sponsorship activities on sport activities, arts and scientific events will be a model of the legitimacy of their presence in the community, may even be regarded as a hero for raising achievement sports, art, and science. Sixth, expand smoke-free areas, not only in the capital but also in the regions. Regions Schools, places of worship, public facilities must truly sterile from cigarette smoke. Seventh, religious leaders, scholars, must agree unanimously that smoking is prohibition because its effect in health. Religious leaders, community leaders no longer give bad example by smoking in public is seen and imitated by children. All the strategies must able to restrict the development of smoking habits in the community. This is consistent with research (Wibowo, 2010) which states that the early adolescent conduct drug abuse started from smoking, by reason of lowering the tension, the development of an unconscious habit, association with socializing, fun capabilities, and physically addicted to nicotine. The next strategy is law enforcement to drug traffickers.

Punishment given should be able to provide a deterrent effect not only to the players but also to the wider community. And the next strategy is the concept of health of the victim drug rehabilitation both physical and psychological rehabilitation, because they are not only suspect but also as victims of drug trafficking syndicates and international sellers.

## CONCLUSION

The high rate of drug abuse in Indonesia has cost the country both economically and socially. If efforts aren't effective, Indonesia will lose one generation of people. Protection of the nation's generation shouldn't be only done by a core family of each family, but also done by both central and local government. That will create a safe environment from circulation and drug abuse. Comprehensive effort both in terms of culture, health and law enforcement will have a significant impact on reducing the amount of drug abuse.

## REFERENCE

- [1] *Undang-undang Republik Indonesia No. 36 Tahun 2009 Tentang Kesehatan*. Retrieved from [www.depkes.go.id](http://www.depkes.go.id) on August, 18 2014.
- [2] Badan Narkotika Nasional, (2008). *Laporan Survei Penyalahgunaan Narkotika di Indonesia, Studi Kerugian Ekonomi dan Sosial Akibat Narkotika*, Badan Narkotika Nasional dan Pusat Penelitian Kesehatan Universitas Indonesia. Retrieved from [www.bnn.go.id](http://www.bnn.go.id) on 19 August 2014.
- [3] Badan Narkotika Nasional, (2008). Lampiran Press Release Akhir Tahun Badan Anti Narkotika Nasional. 2013. Retrieved from [www.bnn.go.id](http://www.bnn.go.id) on August 18, 2014.
- [4] Badan Pusat Statistik, (2004) *Survei Ekonomi Nasional 2004*. Retrieved from <http://www.kpai.go.id/tinjauan/menyelamatkan-anak-dari-bahaya-rokok/> on August, 19 2014.
- [5] BBC, (2014). *Pembebasan Corby Tanda Lemahnya Perang Atas Narkotika*. Retrieved from [http://www.bbc.co.uk/indonesia/forum/2014/02/140207\\_forum\\_corby.shtml](http://www.bbc.co.uk/indonesia/forum/2014/02/140207_forum_corby.shtml) on August 18, 2014.
- [6] Komite Perlindungan Anak Indonesia, (KPAI), (2013), *Menyelamatkan Anak Dari Bahaya Merokok*. Retrieved from <http://www.kpai.go.id/tinjauan/menyelamatkan-anak-dari-bahaya-rokok/> on August, 2014



## ORAL TRADITION “ANDUNG”, TOBA BATAK SOCIETY THE PRESERVATION AND CULTURE REVITALISATION

Dra. Sinta Diana Martaulina, M.Hum.

Politeknik Mandiri Bina Prestasi Medan, [sintadianamartaulina@yahoo.com](mailto:sintadianamartaulina@yahoo.com) 081375806558

*Andung* is an oral tradition Toba Batak people, which is sung to lament the death of the vocal melodies grief. In the spoken text that contains the outpouring of feelings to mourn a loved one's body. This study aims to determine the factors that influence the changes and shifts *andung*; function and meaning *andung*; find the value of the hobo culture contained in the text *andung* and assess the value of local knowledge (local wisdom) grandmother text in languages and literature. Arkataipel Theory and Semiotics in qualitative descriptive method. Oral tradition *andung* documented, recorded and listened to live when funerals take place. Findings indicate that oral tradition grandmother at funerals Toba Batak society began to change, eroded by the changing times through factors: religion, education, modern culture, and economic nature. Function and meaning *andung* also shifted or changed along with the times. Community cultural values Batak Toba spoken in the text *andung* always uphold *hagabeon* (success), *hasangapon* (honor), *hamoraon* (wealth). Mutual respect, health, honesty, and courtesy in the grandmother is a very good local knowledge. Oral tradition as a cultural *andung* would be able to keep up with the times through the use of the values of local wisdom to solve the nation's problems. *Andung* as a heritage revitalization reactivated as a cultural capital in solving national problems.

Key word: *andung*, Toba Batak Society, Preservation, Revitalisation

### 1. Background

"This world is a stage", says the Toba Batak society's behavior while lamenting the bodies that lie in a funeral home. In this lament Toba Batak society referred to as singing grandmother's death, which spontaneously and melodi. Grandmother is one of the oral tradition that is almost extinct Toba Batak Society swallowed the times. Oral tradition, the tradition and customs of the community can be seen as an important and valuable cultural asset, which is worth examining and preserved.<sup>1</sup> Oral tradition can be a cultural force and one of prime importance in the formation of identity and build a civilization. Grandmother is one of the oral tradition Toba Batak society are very important to be studied and preserved. Shape preservation is not to maintain the continuity of the oral tradition, but with the process of revitalization of the noble values contained in the mandate of the grandmother.

Toba Batak Society attachment to ancestral heritage can be seen in inherited hereditary. Along with the times, the oral tradition grandmother has begun to shift and change by time. Civilization and the inclusion of religious elements make the hobo culture began everlasting by contemporer time. Tradition as part of literature and the result is a form of culture. Literature and culture have the same object, namely society and culture, society as a social fact, humans as cultural beings.<sup>2</sup> Cultural inheritance is not something that is easily transferable away from one generation to the next. That is why, the generation of the modern age is no longer "chanting" grandmother as they had done the previous grandparents. Usually, the parents (elderly) who do this oral tradition. However, young people now appreciate the expression of sorrow through the shipment of flowers board. Provide time in the ceremony / indigenous deaths in Toba Batak society for the younger generation is a consideration. Now, all individuals are more likely to think of themselves rather than join the community mourning that takes time and costs to be taken into account.

---

<sup>1</sup> Sibarani, Kearifan Lokal "Hakekat Peran dan Metode Tradisi Lisan (Jakarta. Asosiasi Tradisi Lisan(ATL,2012),p.12

<sup>2</sup> Ratna ,Teori, Metode, dan Teknik Penelitian Sastra(Yogyakarta.Pustaka Pelajar,2004).p.14

This is the background, rites / habits "mangandung" eroded over time, from the past generation to the younger generation today.

The gap is at the pros and cons of intergenerational in maintaining and preserving indigenous oral tradition. On the one hand, the older generation wants ritual grandmother was kept alive as a legacy of oral tradition that must be maintained. Grandmother is a form of respect for the services rendered to the person who has died. In the latter respect, before the body was buried or taken to his hometown, "mangandung" last chance to express spark feelings of grief with words regularly, beautiful, and full of sorrow. Toba Batak society "mangandung" an important part of the tradition. That is why, if a child does not know how to "mang-andungi", parents then people will call it *na so marada*<sup>3</sup> "uncultured" people.. The term "mang-andungi" is very different from the "manangisi". Toba Batak society ancestor advised: "*Dakdanakdo sitangisan , natua-tua siandungan*" "children who are cried, but the oldest who are sang.

Thus, the revitalization of the preservation of oral tradition "mangandung" as cultural treasures can be realized by providing the widest possible opportunity to all people, especially the Toba Batak society to explore the great value contained in the culture "mangandung" through research, assessment, and teaching.

## **2. Preservation of Tradition Noble Values of "Andung"**

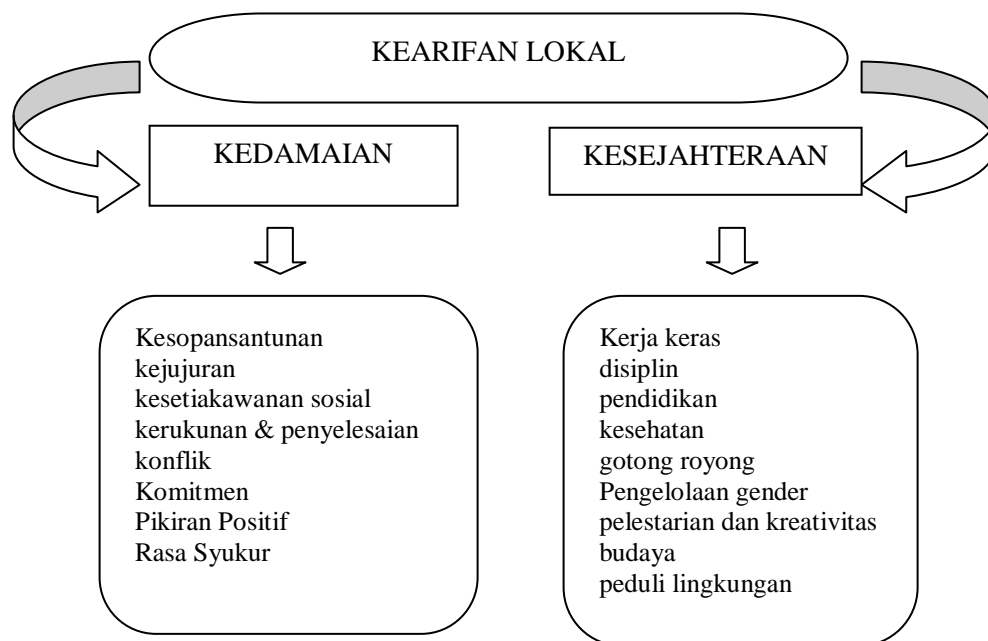
Revitalization efforts undertaken by the younger generation to preserve the oral tradition grandmother culture is to preserve cultural values Toba Batak society. The values are summarized Toba Batak society attempt to use his intellect (cognition) to act and behave towards something objects or events that occur in a particular space. These values are known as local wisdom (local wisdom). Local knowledge is ideas or values, local views (local), which is wise, full of wisdom, good-value, which is embedded and followed by members of the community.

Culture and local knowledge is closely related to Toba Batak society, meaning that everything contained in the culture Toba Batak society are influenced owned by Toba Batak society. Culture grandmother can be seen as one of the oral tradition down from one generation to the next, which is hereinafter referred to as super organize. Local knowledge has a value of its own, the values contained in the local wisdom can be reflected in everyday life. The local knowledge that reflects cultural values Toba Batak society include welfare, hard work, discipline, education, mutual help, gender management, preservation, and cultural creativity, care for the environment, peace, courtesy, honesty, social solidarity, harmony, conflict resolution, commitment , positive thoughts, and gratitude, which are grouped into local wisdom (core local wisdom) that prosperity and peace. Local knowledge is the main capital Toba Batak Society in establishing itself without damaging social order adaptive with the surrounding natural environment. Local wisdom Toba Batak society constructed of social values that uphold the social structure of Toba Batak society and has a function as a guide, the controller, and signposts to behave in various dimensions of life, both when dealing with others and with nature.

In a cultural tradition or oral tradition grandmother there are different values and cultural norms as heritage, which according to its function in the social life of the community organizing can be classified as local wisdom. There are two types of local knowledge nucleus (core local wisdoms), which is indigenous to (1) prosperity or well-being and (2) peace or kindness. Can be seen more clearly in the chart below. Thus, efforts to conserve the culture grandmother had done include heritage values and norms that serve to organize socialization of Toba Batak society life.

---

<sup>3</sup> T.M. Sihombing. Jambar Hata tu Ulaon Adat(Tulus Jaya,1997).p.337



**Bagan 5.1 Variety of Local Wisdom<sup>4</sup>**

## 2.1 Value Of Respect

“Mang-andungi” done not only by close relatives who died alone, but others can also “mang-andungi”. Local wisdom traditions clearly visible grandmother who “mang-andungi” and who “di-andungi” so kinship when “mang-andungi”i deceased person can be known. Thus kinship shows a sense of respect for the deceased on the virtues of the deceased during the life of the person honored if able do “mangandung”. Inheritance *Andung* expected to children as well as children are now more respect for the elderly. In case contains not only a cry that simply flows but the grandmother we can know how the parent and child relationship. When his clever “mang-andungi” means he is more familiar with the closeness of how the lives of parents indicated in affection for the life of his parents. So if you can not mangandungi then told me no grief and affection to his parents. Society will this family assemmed less affection and respect for his mother who died because no one is able “mang-andungi” her dead mother. So it is clear that the grandmother through the contents we can determine the extent of the relationship between the deceased with the “mang-andungi”. The death is considered as a very sacred farewell. The last moments need perpetuated through monologues grandmother by using subtle Batak language as devotion in honor of those who have died. It is a manifestation that the Toba Batak Society are very respectful relatives though they never quarrel when he died.

## 2.2 Health

In the grandmother also seen a local knowledge of health. In this case the question is health related stress experienced by people who are grieving that in this case is the grandmother speakers. Physical health because sadness experienced disturbed long. Where the speaker grandmother had kept a lot of sorrow to myself. But through a grandmother, grief can not forgotten in the emotion that can not be changed through grandmother. This will cause the burden of his mind and his grief becomes lighter and feel loose chest. Health that is the local knowledge of a tradition grandmother.

<sup>4</sup> Sibarani. 2012. Kearifan lokal Hakekat, Peran dan Metode Tradisi Lisan.p.176

### 2.3 Honesty

In the tradition of honesty grandmother is also one of the value of local knowledge. This can be seen in “andung” below what the hidden expressed in the liver “pang-andung”, which had been buried now speech act complete without something is covered, both the good and the bad attitude of a person.

### 2.4 Courtesy Language

In the tradition grandmother also looks politeness compensation in the language. This is illustrated in the text grandmother who uses subtle Batak language. The grandmother words implies very deep and filled with respect and courtesy language in conveying sadness by speakers “pang-andung” them. The oracle delivered in the grandmother politeness all contain elements of compensation. This will teach the younger generation to speak a language that is polite and gentle. Set the norm speak greetings and spoken name, based on the degree of courtesy we can also learn from the grandmother.

*...ndang berengon ku be **simangarudok mi***

*(“ I can,t see your body anymore”)*

*umbahen naso ro ahu mandulo ho*

*(“That is why I come to see you”)*

*nga **marsiaginon ho dipapan naso habalunan i***

*(“You have died in your coffin”)*

***sirindang ubean ki***

*(“my lovely ”)*

*eiii...eiii...eiii....Ompung Butet amang marsiturian jolo hita hasian*

*(“Butet’s grandfather, we used to take and give by a story”)*

*dohot **simangkudap i...i...i***

*(“and also made fun of some one by a joke”)*

***parsinuan tunas si adosan ki***

***si nuan tunas na bi nalos iii...iii...iii...***

*ndang ka lulu an be da hasian*

*(“can’t be looking for any where”)*

*ndang tolap i **simalolongkhi***

*(“My eyes can not be able”)*

*Ompung Butet nauli.. eiii ...eiii...eii...*

*(“honorable Butet’s grandfather”)*

*ndang hu paborhat i **siadosan mi***

*(“I can,t be able to let you away”)*

***ima sinuan beui eii..eiii.eiii...***

**(“the father of my lovely kids”)**

*songon hariara na marokat i hasian*

*(“like a fig tree which has falled down”)*

*pinaborhat ni inang tua mi*

*(Those who asked went away of your older mom”)*

*songon na hu sapot i ...i..i*

*(“like an astringent to the taste”)*

**na baru pe Ompung Butet si bijaon mu da ito**

**(“It is just now, Butet’s Grandfather”)**

*ima si sumbaoon ki*

**(“That is I feel suffer”)**

*hu usung i sian tano Bali....ei...ei...ei*

*(“I bring from Bali”)*

*ompat i nian Ompung Buiet pinaribot mi da ito*

*(“There are four kids” )*

*rindang siubean ki*

*(“The kids whom I lovely”)*

**na baru borhat pe silasapon mu da ito**

**(“your son is just right passed away”)**

*si nuan tunas na binalos i..*

*(“The son those whom you love”)*

Some of the words above shows that the language used in a very classic grandmother, not the everyday language (daily words). Every parents who able “mang-andung” are clever and often expected attendance at every death. Usually people who are good at containing the expression can convey feelings of sadness with words grandmother appropriate, so as to shed tears for those who hear it<sup>5</sup>.

*Simangarudop* (Body) word is defined as the back, while the everyday language *.Marsiaginon* means to suffer in everyday sadly language *.Simangkudap* (joke) means mouth and more subtle than in a daily words (colloquially) are always pronounced by the tongue. *Simalolongkhi* (my eyes) meaning the more subtle than in everyday spoken eyes. *Sirindang ubean* is the daughter in everyday we call *Boru* (girls). *Sibijaon* is the language of everyday Uncle bone.The main characteristic is the use of language grandmother grandmother. In the grandmother also contains the value of the beauty of the language in

---

<sup>5</sup> B.A. Simanjuntak, *Pemikiran Tentang Batak Toba.*( Medan, Pusat Dokumentasi Pengkajian Kebudayaan Batak, 1986), pp. 251-252

which words grandmother (words of grandmother) also contains the style of language and meaningful connotation that style is more beautiful grandmother. In the example above grandmother there are several style that embellish the grandmother contents are *tukkot solu*, *panabian*, *sira siguguton*, *manuan* in healers, the *Hutu* ida, the *ida gomit*.

*songon **tukkot ni solu** do ahu ito marningot na lungun i*

*eiii...eiii...eiii*

Meaning : Like a stick of boat for me to remember whole grief suffer .

Denotation : stick of boat is a tool for rowing Used Toba Batak society hearts  
move hearts

Connotation : In Life We Shall Remain wading powerfull And differences in control hearts facing suffering husband .

*songon **panabian i jadi ndang haputian ahu i** Op. Vani nauli*

Meaning : as a former rice that has been mown that can not be quoted again

Denotation : rice that has been harvested and the fall harvesting and no longer able to cite or reassemble

Connotation : can no longer unspeakable misery ( suffered )

*jadi ndak tardok ahu si taonan khi songon **sira siguguton i***

Meaning : not regarded me again what I've been through this suffering like the taste of salt .

Denotation : cicicipi salt and salty tastes so suffering life

Connotation : that he was suffering

*songon na **manuan i di balian i** ,ndang ka jojoran ahu i hasian*

*songon na **manuan di balian i** , si taonan ki eiii..eiii...eiii*

Denotation : planting in the field is an activity / process plant rice in the rice fields by farmers .

Connotation : All grief can not be mentioned one by one in URLs by planting rice and neatly arranged parallel and she bears all the heavy load without complaining like planting rice to be lowered and tireless to be prepared on the same day.

*si taon naborat i*

*tu dia ma amang lu lu do ahu ito*

***songon si ida hutu i***

*jala dior-dior do ahu amang **songon si ida gomit i***

Denotation: Ticks are very small animals living area moist and very itchy. nymphs are smaller and smoother very hard to find and should be carefully and slowly Pleas.

Connotation: In her grief bear looking for tell where he's even confused do not know where he is going.

However, the value of the beauty that looks now as it used to. The uniqueness of the characteristic grandmother was an interesting way "si pang-andung" voice that sometimes rises sometimes down,

sometimes speechless sometimes sing though not with musical accompaniment. There was no handkerchief to wipe the tears and snot and that's where the beauty of art is currently appealing his nose grandmother who sang eiii ... eiii ... eiii or heee heee ..... .. And the beauty of it was no longer the time grandmother it is dominated by somal language (colloquial) today. Arts when he pulled his breathing accompanied by pulling his nose is not seen anymore in the current now available handkerchief and wipes. it is clearly visible on the grandmother (*ommpung*) Spiritual where ever he pulled his nose and wiped his eyes with a handkerchief

### 3. Revitalization In Noble Values Tradition Andung

#### 3.1 Kinship

Efforts to conserve the great value in the oral tradition grandmother done to raise awareness and understanding of the reality of cultural history. Preservation of the cultural values is an indication attitudes and behavior in the social and cultural life of the Toba Batak society. Now the preservation of oral tradition grandmother was not forced to do by the next generation. However, the existence of values and norms "batakness" which builds on the inner embedded pursued Toba Batak society. Kinship in Toba Batak society include primordial tribal life, love on the basis of blood relationship to realize the harmony among humans. Three cookstove embodiment contains the idea of human life balance. The phrase "Somba marhula-hula" (respect to the uncle, meaning of respect to the family of the husband and wife), "manat Mardongan Sabutuha" (use care to relatives of the same surname), and "elek marboru" (act and behave affection in 'daughter', meaning of respect to the family of the our daughter). The expression of poetry has been deeply rooted in the life of Toba Batak society kinship system.

According to Sibarani associated with brother and sister applicable motto "once as brother and sister remain do-", because Toba Batak society could not move the clan, even if they are hostile to many friends semarganya. Batak philosophy about brotherhood, "SongonTampulon aek do na Mardongan Sabutuha."<sup>6</sup> Meaning: properties similar to the properties of water brotherhood let repeatedly cut continued to meet and unite. This fact is also confirmed by Sibarani (2005: 47) states that, "As people in the same surname, they empathize, as siblings. This is due to the first people who lived in the same surname in the village (Huta), then they are to work together in working the fields, citing the results, care of watering, cleaning showers, and also got children.

Boru by Sibarani, in kinship Toba Batak society divided into two, namely hela (husband and our daughter) and Bere (kid sister who is regarded by Toba Batak Society elements Boru followed his mother). Philosophy of "daughter" Bungkulan do Boru." Meaning: it is a ridge daughter (meaning rooftops), a view that philosophy is: if there is a dispute between the "hula" which makes the rift between them that, then "daughter" the one who is obliged to eliminate the cracks so that they are disputing it back compact and united, similar to the ridge beam home that binds and unites both sides of the roof of the house. Of course "Boru" in this case rose degrees became king punisher and indeed he was treated by the relevant hula way and will allow it to sit on the stave "daughter" (honorable seat). However, "Boru" who hold fast to customs may not accept the invitation and will retain his seat in port(section seating for Daughter) and precisely the same attitude that makes the ride "daughter's degree"'s degree in view of his hula that certainly remember philosophy: "Lam unduk do Biur eme na ni Marisi"<sup>7</sup>. (Meaning: Rice is increasingly contain more ducking). While "Hula-hula" by Sibarani has properties that are sensitive and fragile. If not careful in action or treatment of "hula", simply existing relationships to be broken and usually can not be repaired and eventually erased altogether. Batak philosophy regarding hula reads: "Sigaton laila do na marhula-hula". Meaning: Similar to the chicks, the time determines the sex, we examine the tail. So we must learn the hula how the properties as well as his will and the results we use as a guide in our association with them<sup>8</sup>.

#### 3.2 Religion

Before the entry of religion into tano hobo, Toba Batak Society is a human being who had great respect

---

<sup>6</sup> T.M. Sihombing, *Filsafat Batak Tentang Kebiasaan-kebiasaan Adat Istiadat* (Jakarta:Balai Pustaka, 2000), pp. 74- 75.

<sup>7</sup> T.M. Sihombing, *Ibid.* pp.77-78.

<sup>8</sup> T.M. Sihombing, *Ibid.*p.76.

and appreciate the presence of its creator. Toba Batak society has now chosen religion and belief in accordance with the philosophy batak ethnics. Since the arrival of Nomensen, some areas (bonapasogit<sup>9</sup>) has placed the region spread of Christianity. This is the forerunner of glory HKBP (Huria Kristen Batak Protestant) have kept the peace of the values of local wisdom through Christianity. Expression obedient and subservient to the Almighty who first appreciated through rites / habits prevalent, no longer idolize Debata At So Na Bolon. Shifts and changes have changed the "mangandung" no longer function as a tribute to the deceased. When the mourners "mangandungi" bodies, the sudden interruption of the sexton to sing the hymns of the church as a consolation for all the tragedy experienced by families who are grieving. With spontaneous mourners were present were singing together. Even religious leaders also argued that the oral tradition act grandmother is with religion (Christianity). Establishment of religion (Christianity) has alerted the Toba Batak Society that is different from the life of the deceased person's life that is still alive. Death is not to be mourned constantly, death is an inevitable destiny. Since the presence of religion in the life of Toba Batak Society accepted, its role has brought changes to the harmony in the family and society through religious values such as love, mutual help, cooperate, and others. This is one factor that reduced grandmother speakers speakers already scarce.

### **3.3 Legal**

Traditionally, the law in Toba Batak society life can not be changed before believed to be true that the new rules and the law better than the customary laws inherited from his ancestors. Customary law in Toba Batak society called homeopathic dohot uhum which implies rules and laws. Value slave dohot uhum a cultural value Toba Batak Society hereditary, both based on customary law and formal law (modern). Therefore, one of the basic principles of traditional law is that it can not be changed, including customary law Toba Batak Society . Vergouwen (2004: 176) argues "The law was deemed as 'ancestral customs first-born into the world, sahala ancestors, indigenous "ni na jumolo impunta Tubu, sahala ni Amanta". One concept that is flattering wisdom ancestors, who formulated the law seklaigus supporting authority.

"Customary law is a set of rules that come from "Debata Mulajadi Na Bolon" (God) through uncle bone. Traditionally, customary law regulates Toba Batak society life, both with fellow human beings, natural surroundings, the spirit of the ancestors, as well as with "Debata Mulajadi Na Bolon". Therefore For Toba Batak society, awareness of indigenous religious meaning while formal legal awareness implies human relations.

### **3.4 Education**

Increasing number of Toba Batak Society which has a higher education, the less interest MBT to learn and perform oral tradition grandmother. Educational factors play a role in affecting the oral tradition grandmother to not do funerals. Educational background owned by the younger generation now has to think the things that are logical and real. The phrase "time is money" has opened the thinking of young people to pay attention to the economics and practicality. Through education they achieved, the younger generation considers holy grandmother is a job that a waste of time. Instead of lamenting the dead, young people better figure out what to do to achieve a better life. Discipline and hard work is the key to success to be successful. Success can only be achieved through education because education is impossible without change. Determination and will to succeed cause Toba Batak Society known as nomads successful society. Today, the popularity of successful Toba Batak Society has begun to be taken into account, both in the political field, economy, social, legal and cultural.

### **3.5 Culture**

Older generation concerns about "the perpetuation of" cultural heritage "mang-andung" Toba Batak Society understandable considering the number of external influences that lead to a culture will routinely ignored, even could also lost to time. As part of the culture Toba Batak Society , grandmother deserves to be preserved, but not in a way of mangandung maintain its rituals. Preservation can be done with the revitalization tailored to the needs and abilities society itself. Toba Batak Society is a culturally rich community. That is why in every cultural activities, To"ba Batak Society can not be separated from philosophy Dalihan Na Tolu (furnace three feet), the "manat Mardongan Tubu", electrocautery "Boru,

---

<sup>9</sup> Bonapasogit means territory of Toba Batak Society



Somba marhula-hula". This philosophy that from birth to dying, Toba Batak Society life always bound in the structure of family and kinship. This was done to align the harmony and balance of Toba Batak Society in identity and social status in order to align and be recognized.

The emphasis on community about the importance of digging noble values contained in the tradition of "mang-andung" will foster the understanding that cultural wealth priceless nation is a cultural repertoire that must be preserved. Conservation efforts need to be done considering the cultural values and attitudes that become a source of human behavior in social life is important. Departing from discourse to improve the condition of a nation that is now multidimensional crisis, various groups expressed the need for excavation effort cultural values of the past. Requirement of identity or identity of a nation in the midst of globalization inspire the nation to empower cultural values needed to face the challenges of the future. Consciousness to rediscover the cultural roots that grow and thrive in the community confirmed the idea to further improve research, assessment, and dissemination of cultural repertoire of nearly vanished.

Revitalization in the preservation of oral tradition "mang-andung" as cultural treasures realized by providing the widest possible opportunity to all people, especially the Toba Batak Society to explore the great value contained in the culture "mang-andung" through research, assessment, and teaching. Revitalization efforts undertaken by the younger generation in the oral tradition of cultural to take care grandmother is to preserve cultural values Toba Batak Society to use his intellect (cognition) in the act and behave towards something objects or events that occur in a particular space. These values are known as local wisdom (local wisdom). Local knowledge is ideas or values, local views (local), which is wise, full of wisdom, good-value, which is embedded and followed by members of the community. Culture and local knowledge is closely related to Toba Batak Society, meaning that everything contained in the culture Toba Batak Society influenced owned by Toba Batak Society. Culture grandmother can be seen as one of the oral tradition down from one generation to the next, which is hereinafter referred to as "superorganize". Local knowledge has a value of its own, the values contained in the local wisdom can be reflected in everyday life. The local knowledge that reflects cultural values include welfare, hard work, discipline, education, mutual help, gender management, preservation, and Toba Batak Society cultural creativity, care for the environment, peace, courtesy, honesty, social solidarity, harmony, conflict resolution, commitment, positive thoughts, and gratitude, which are grouped into local wisdom (core local wisdom) that prosperity and peace<sup>10</sup>

#### **4. Cover**

Local knowledge is the main capital Toba Batak Society in establishing itself without damaging social order adaptive with the surrounding natural environment. Local wisdom Toba Batak Society constructed of social values that uphold the social structure of Toba Batak Society and has a function as a guide, the controller, and signposts to behave in various dimensions of life, both when dealing with others and with nature. From the above we can see that the oral tradition grandmother at the Toba Batak people can be preserved as a heritage that can be revitalized in the noble values such as mutual respect, maintain health, maintain honesty through linguistic politeness in order to obtain peace and prosperity both on earth and after we no after we died.

---

<sup>10</sup> Sibarani. *ibid* 133-134

## BIBLIOGRAPHY

- Arikunto, Suharsimi. 1999. *Prosedur Penelitian Suatu Pendekatan Praktek*. Penerbit Rineka Cipta.
- Harahap, Basyral Hamidy dan Hotman M. Siahaan. 1987. *Orientasi Nilai-nilai Budaya Batak*. Jakarta: Sanggar Willem Iskander.
- Hariara. JM. 1987. *Hata Batak Maninggoring. Rangsa ni andung dohot hadatuan*.vol.1. (tanpa penerbit)
- Hasselgren, Johan. 2008. *Batak Toba di Medan: Perkembangan Identitas Etno-Religius Batak Toba di Medan (1912-1965)* ( Diterjemahkan Oleh Tim Bina Media Perintis dari *Rural Batak, Kings in Medan*). Medan. Bina Media Perintis.
- Hodges, W. Robert. 2006. "Tu Dia Ho, Dung Mate Ho?" Manifestasi dan Mediasi Disonansi Kognitif dalam Konteks Lagu-lagu Ratapan Di Kalangan Kristen Protestan Batak Toba. *Jurnal Ilmu Pengetahuan dan Seni*. Vol.2. No.1. Departemen Etnomusikologi Universitas Sumatera Utara.
- Hutagalung, Achirani (2001). *Klasifikasi Andung pada Masyarakat Batak Toba di Desa Pintu Bosi Kecamatan Laguboti, Kabupaten Toba Samosir*. Skripsi. Etnomusikologi-Universitas Sumatera Utara.
- Junita, Batu Bara. 2006. *Vio: Opera Monolog*. *Jurnal Ilmu Pengetahuan dan Seni*. Vol.2. No.1. Departemen Etnomusikologi Universitas Sumatera Utara.
- Koentjaraningrat.1980. *Sejarah Teori Antropologi I*. Jakarta: Rineka Cipta.
- Koentjaraningrat.1990. *Pengantar Ilmu Antropologi*. Jakarta : Aksara Baru.
- Koentjaraningrat. 1997. *Pengantar Antropologi Pokok-pokok Etnografi II*. Jakarta: Rineka Cipta.
- Koentjaraningrat. 2002. *Pengantar Ilmu Antropologi*. Jakarta : Rineka Cipta.
- Kridalaksana, Harimurti.2008. *Kamus Linguistik*. Jakarta: Gramedia Pustaka Umum Utama.
- Kozok ,Uli. 1999 . *Warisan Leluhur Sastra Lama dan Aksara Batak*. Jakarta: KPG (Kepustakaan Populer Gramedia).
- Lumbantobing,Andar. 1996. *Makna Wibawa Jabatan Dalam Gereja Batak*. Jakarta. BPK Gunung Mulia.
- Marbun & Hutapea, 1987. *Kamus Budaya Batak Toba*. Jakarta : Balai Pustaka.
- Pardede. R.A. Lumongga. 2010. *Masisisean Di Ulaon Adat*. (tanpa penerbit)
- Pudentia, MPSS. 2008. *Metodologi Kajian Tradisi Lisan*. Asosiasi Tradisi Lisan (ATL).
- Pasaribu, Rudolf H. 12 Mei 2012. *Makalah Adat dan Injil*. Seminar sehari Yayasan Penginjilan dan Penelaahan Alkitab Sumatera Utara. YPDPA-SUMUT. Medan .
- Sangti, Batara, 1977. *Sejarah Batak*. Balige: Karl Sioanipar Company.

- Sarumpaet, J.P. 1995. *Kamus Batak Indonesia*. Jakarta: Erlangga.
- Sartini . 2004. *Menggali Kearifan Lokal Nusantara Sebuah kajian Filsafati*. Jurnal Filsafat, Agustus 2004, Jilid 37, Nomor 2. Universitas Gajah Mada.
- Schreiner Lothar. 2008. *Adat dan Injil. Perjumpaan Adat dengan Iman Kristen Di Tanah Batak*. Jakarta. BPK Gunung Mulia.
- Siahaan, Nalom. 1982. *Adat Dalihan Na Tolu Prinsip dan Pelaksanaannya*. Jakarta. Tulus Jaya.
- Siahaan, Mangaraja Asal. *Adat dohot Umpama*. Jakarta. Tulus Jaya.
- Sibarani, Robert 1999. Pemetaan Tradisi Lisan Di Sumatera Utara. Asosiasi Tradisi Lisan (ATL).
- Sibarani, Robert .2004. *Antropolinguistik*. Medan : Poda.
- Sibarani, Robert 2005. “ Dalihan Na Tolu dalam Masyarakat Batak Toba”, Dalam Ahmad Samin Siregar, dkk. *Peranan Filosofi Adat dalam Merekat Kesatuan Bangsa Di Sumatera Utara*. Medan: Forkala (Forum Komunikasi Antar Lembaga Adat) Sumatera Utara.
- Sibarani, Robert.2012. Kearifan Lokal “Hakekat, Peran, dan Metode Tradisi Lisan. Asosiasi Tradisi Lisan (ATL). Jakarta.
- Sihombing, T.M. 2000. *Filsafat Batak (tentang kebiasaan-kebiasaan Adat Istiadat)*. Jakarta : Balai Pustaka.
- Sihombing, T.M. 1997. *Jambar Hata Dongan Tu Ulaon Adat*. Jakarta : Tulus Jaya.
- Simanjuntak, Bungaran Anthonius. 2006. *Konflik Status & Kekuasaan Orang Batak Struktur Sosial dan sistem Politik Batak Toba hingga 1945: Suatu Pendekatan Sejarah, Antropologi Budaya Politik*. Jakarta: Yayasan Obor Indonesia.
- Simanjuntak, Bungaran Anthonius. 2003. *Konflik Status & Kekuasaan Orang Batak Toba*. Yogyakarta: Jendela.
- Simanjuntak, Bungaran Anthonius . 1986. *Pemikiran Tentang Batak*. Pusat Dokumentasi dan Pengkajian Kebudayaan Batak. Medan: Universitas HKBP Nommensen.
- Sitorus, Langsung Maruli. 12 Mei 2012. Makalah “Ulos dan Jambar dalam adat Batak disoroti dari injil”, Seminar Sehari Yayasan Penginjilan dan Penelaahan Alkitab Sumatera Utara, Medan.
- Situmorang, Sitor.2004. *Toba Na Sae*. Jakarta: Komunitas Bambu.
- Vergouwen, J.C. 2004. *Masyarakat dan Hukum Adat Batak Toba*. Yogyakarta: LkiS.
- <http://haposanbakara.blogspot.com/2011/04/andung-andung-andung.html> up load in 14 April 2014
- <http://pagarandolok.blogspot.com/2009/04/andung-andung-atau-mangandung.html> up load in 23/3/2014
- <http://sukutapanuli.blogspot.com/> up load 14 februari 2015



**DIREKTORAT PENELITIAN DAN PENGABDIAN MASYARAKAT  
(DPPM) UUI**  
 Jl. Alue Naga, Tibang, Kec. Syiah Kuala - Banda Aceh  
 Aceh - Indonesia.  
 Phone (0651) - 7555566.

**UNIVERSITAS UBUDİYAH INDONESIA**  
 Jl. Alue Naga, Tibang, Kec. Syiah Kuala  
 Banda Aceh  
 Aceh - Indonesia.  
 Phone (0651) - 7555566.

## Special Award & Supported



KEMENTERIAN PENDIDIKAN  
DAN KEBUDAYAAN  
REPUBLIK INDONESIA



9 772442 467000

